

DISCONTINUED
PRODUCT



UPStation® S

Power Protection

User Manual

English



**SAVE THESE IMPORTANT UPS AND BATTERY
SAFETY INSTRUCTIONS**

**CONSERVER CES INSTRUCTION. CETTE NOTICE
CONTIENT DES INSTRUCTIONS IMPORTANTES
CONCERNANT LA SÉCURITÉ.**

WARNING: Lethal voltages may be present within this unit even when it is apparently not operating. Observe all cautions and warnings in this manual. Failure to do so MAY result in serious injury or death. Refer UPS and battery service to qualified service personnel. Keep unauthorized personnel away. Never work alone.

Clean UPS with only a dry cloth. Do not use liquids or aerosol cleaning fluids.

Only trained engineers authorized by Liebert should perform troubleshooting. If the UPS develops a fault, check the Alarm History and Input Disturbances recorded in the Event Log (LCD display menu item 3). See **Alarm Messages, Meanings, and Corrective Actions** in the Appendix. Consult Liebert at 1-800-222-5877 for persistent unresolved problems. Do not use UPS if not performing to specification. Call Customer Service to replace fuses and diagnose cause of failure.

Batteries within the UPS provide standby power. During normal operation, the batteries automatically charge and the UPS control circuit automatically tests them. The UPS displays an alarm message if there is a battery charger problem or if the battery fails a test. Call Liebert at 1-800-222-5877 for battery maintenance or replacement. When replacing batteries, use the same number and type of batteries.

Lead-acid batteries contain hazardous toxic materials. Handle, transport, and recycle in accordance with federal, state, and local regulations. DO NOT dispose of batteries by fire; they may explode. DO NOT open or mutilate batteries; released electrolyte is harmful to skin and eyes, maybe toxic. A battery presents a risk of electrical shock and high short circuit current. Lead-acid batteries present a risk of fire due to hydrogen gas generation. Observe these precautions when working on batteries:

- Remove watches, rings, or other metal objects.
- Wear rubber gloves and boots and use tools with insulated handles. DO NOT lay tools or metal parts on top of batteries.
- Unplug UPS prior to connecting or disconnecting battery terminals. Remove battery fuses or open battery circuit breaker.
- Remove all battery grounds. Contact with any part of a grounded battery may result in electrical shock.
- DO NOT SMOKE near batteries. DO NOT cause flame or spark in battery area.
- Touch a grounded metal surface to discharge static electricity from body before touching batteries.

CAUTION: This device complies with limits for a Class A computing device, pursuant to Part 15 of FCC rules. Operating this device in a residential area is likely to cause harmful interference to radio and TV reception which the user must correct at his own expense.

AVERTISSEMENT: Des pièces sous alimentation seront laissées sans protection durant ces procédures d'entretien. Un personnel qualifié est requis pour effectuer ces travaux.

Les fusibles à c.c. de la batterie d'accumulateurs opèrent en tout temps à la tension nominale. La présence d'un fusible à c.c. brûlé indique, un problème sérieux. Le remplacement de ce fusible, sans avoir déterminé les raisons de la défektivité, peut entraîner des blessures ou des dommages sérieux à l'équipement. Pour assistance, appeler le département de service à la clientèle de Liebert.

Les accumulateurs plomb-acide contiennent de la matière comportant un certain risque. Les accumulateurs doivent être manipulés, transportés, et recyclés en accord avec les lois fédérales, provinciales, et locales. Parce que le plomb est une substance toxique, les accumulateurs plomb-acide devraient être recyclés plutôt qu'éliminés. Il ne faut pas brûler le ou les accumulateurs. L'accumulateur pourrait alors exploser. Il ne faut pas ouvrir ou endommager le ou les accumulateurs. L'électrolyte qui pourrait s'en échapper est dommageable pour la peau et les yeux. Un accumulateur représente un risque de choc électrique et de haut courant de court-circuit. Les accumulateurs plomb-acide présentent un risque d'incendie parce qu'ils génèrent des gaz à l'hydrogène. Lorsque des accumulateurs sont manipulés, les mesures préventives suivantes devraient être observées:

- Retirer toutes montres, bagues, ou autres objets métalliques.
- Porter des gants et des bottes de caoutchouc et utiliser des outils avec manchon isolé. Ne pas déposer les outils ou les pièces métalliques sur le dessus des accumulateurs.
- Interrompre la source de charge avant de raccorder ou de débrancher les bornes de la batterie d'accumulateurs.
- Déterminer si l'accumulateur est mis à la terre par erreur. Si oui, défaire cette mise à la terre. Tout contact avec un accumulateur mis à la terre peut se traduire en un choc électrique. La possibilité de tels chocs sera réduite si de telles mises à la terre sont débranchées pour la durée de l'installation ou de l'entretien.
- NE PAS FUMER lorsque près des accumulateurs. NE PAS produire de flammes ou d'étincelles près des accumulateurs.
- Décharger toute électricité statique présente sur votre corps avant de toucher un accumulateur en touchant d'abord une surface métallique mise à la terre.

L'électrolyte est un acide sulfurique dilué qui est dangereux au contact de la peau et des yeux. Ce produit est corrosif et aussi conducteur électrique. Les procédures suivantes devront être observées:

- Porter toujours des vêtements protecteurs ainsi que des lunettes de protection pour les yeux.
- Si l'électrolyte entre en contact avec la peau, nettoyer immédiatement en rinçant avec de l'eau.
- Si l'électrolyte entre en contact avec les yeux, arroser immédiatement et généreusement avec de l'eau. Demander pour de l'aide médicale.

Lorsque l'électrolyte est renversée, la surface affectée devrait être nettoyée en utilisant un agent neutralisant adéquat. Une pratique courante est d'utiliser un mélange d'approximativement une livre (500 grammes) de bicarbonate de soude dans approximativement un gallon (4 litres) d'eau. Le mélange de bicarbonate de soude devra être ajouté jusqu'à ce qu'il n'y ait plus apparence de réaction (mousse). Le liquide résiduel devra être nettoyé à l'eau et la surface concernée devra être asséchée.

INTRODUCTION	6
Features	6
Standard System Components	6
Optional System Components	6
UNLOADING THE UPS.....	6
INSTALLATION.....	7
3.5-6 kVA Connections	7
Input.....	7
Output.....	7
3.5-6 kVA Start-up Checklist.....	8
8 - 18 kVA Connections	9
Input.....	9
Output.....	9
8 - 18 kVA Start-Up Checklist	10
OPERATION.....	11
Control Buttons.....	11
LCD Display	11
Initial Start-Up	11
Table #2 Factory Default Settings	12
System Start-Up.....	14
Manual Restart after Manual Off.....	14
Auto-Restart	14
Manual Restart after Low Battery Shutdown or REPO.....	14
Normal Operation.....	14
Battery Operation.....	14
On Battery	14
Battery Recharge	14
Bypass Operation	14
Auto-Bypass	14
Manual Bypass.....	14
Maintenance Bypass Operation	15
on 3.5 - 6 kVA Units	15
Transferring from UPS Operation to Maintenance Bypass Operation.....	15
Transferring from Maintenance Bypass Operation to UPS Operation	15

System Shutdown	15
Manual Off.....	15
Remote Emergency Power Off.....	15
UPS Alarms	15
OPTIONS	16
Distribution.....	16
Configurable Distribution (CD)	16
Load Modules	17
POWER MANAGEMENT.....	25
Getting Started	25
Power Management Programming Elements	26
Loads	26
Events	26
Power Management Sample #1	27
Power Management Sample #2	27
Remote Emergency Power Off (REPO) Cable ...	28
Communications Options	28
SiteNet 1 Shutdown Interface Kits.....	28
SiteNet 2 Power Surveillance.....	28
SiteNet SNMP (Simple Network Management Protocol).....	28
Terminal/Modem Connection	28
RS-232 with User-Configurable Relays	29
Cables.....	29
External Battery Cabinets	30
ROUTINE MAINTENANCE	31
LIEBERT UPSTATION S™	
SPECIFICATIONS.....	31
APPENDIX	32
NEC Wire Gauge Chart	32
3.5 kVA Battery Run Times.....	33
6 - 8 kVA Battery Run Times.....	34
10 - 12 kVA Battery Run Times	35
15 - 18 kVA Battery Run Times	36
Alarm Messages, Meanings, and Corrective Actions	37

Liebert UPStation S™ SITE PLANNING DATA

Power Rating			AC Input				Battery		AC Output				Mechanical Data		
Power Rating kVA / kW	Maximum Upgrade Rating (kVA)	Voltage VAC 3-Wire + Ground §	Full Load Current † Amps	Recommende d External Overcurrent Protection* (Amps)	Internal Battery Time Full / Half Load†† Minutes	Voltage VAC 3-Wire +Ground	Full Load Current‡Amps	UPS Output Circuit Breaker (Amps)	Dimensions in Inches WxDxH	Weight Including Battery (lbs.-)	Heat Rejection at Full Load BTU / HR				
4.5 / 3.6	5.0	200/100	22 A	30 A	12 / 29	200/100	23 A	30 A	9x31x29	270	2170				
	5.2	208/120	21 A			208/120	22 A								
	5.5	220/110, 220/127, 220 L-N	20 A			220/110, 220/127, 220 L-N	21 A								
	5.8	230/115	19 A			230/115	20 A								
6.0	240/120, 240 L-N	18 A	240/120, 240 L-N	19 A											
5.0 / 4.0	N/A	200/100	24 A	30 A	11 / 25	200/100	25 A	30 A	9x31x29	270	2411				
	5.2 / 4.0	208/120	24 A			208/120	25 A								
	5.5 / 4.0	220/110, 220/127, 220 L-N	22 A			220/110, 220/127, 220 L-N	25 A								
	5.8 / 4.0	230/115	21 A			230/115	25 A								
6.0 / 4.0	240/120, 240 L-N	20 A	240/120, 240 L-N	25 A											
8.0 / 6.0	12.0	200/100	36 A	60 A*	17 / 35	200/100	40 A	100 A	18x27x29	560	3616				
		208/120, 208/120 3 Ph. §	35 A			208/120	39 A								
		220/110, 220/127, 220 L-N	33 A			220/110, 220/127, 220 L-N	36 A								
		230/115	31 A			230/115	35 A								
240/120, 240 L-N	30 A	240/120, 240 L-N	30 A	50 A*											
10.0 / 7.5	12.0	200/100	45 A	70 A*	11 / 28	200/100	50 A	100 A	9x31x29	560	4520				
		208/120, 208/120 3 Ph. §	43 A			208/120	48 A								
		220/110, 220/127, 220 L-N	41 A			220/110, 220/127, 220 L-N	46 A								
		230/115	39 A			230/115	44 A								
240/120, 240 L-N	38 A	240/120, 240 L-N	38 A	60 A*											
12.0 / 8.4	N/A	200/100	50 A	80 A	10 / 24	200/100	60 A	100 A	9x31x29	560	5062				
		208/120, 208/120 3 Ph. §	49 A			208/120	58 A								
		220/110, 220/127, 220 L-N	46 A			220/110, 220/127, 220 L-N	55 A								
		230/115	44 A			230/115	52 A								
240/120, 240 L-N	42 A	240/120, 240 L-N	42 A	70 A											
18.0 / 12.6	N/A	200/100	76 A	125 A	10 / 27	200/100	90 A	125 A	27x27x29	780	7593				
		208/120, 208/120 3 Ph. §	72 A			208/120	87 A								
		220/110, 220/127, 220 L-N	69 A			220/110, 220/127, 220 L-N	82 A								
		230/115	66 A			230/115	78 A								
240/120, 240 L-N	63 A	240/120, 240 L-N	63 A	110 A											

* For planned future upgrade. Initially size wiring and overcurrent protection for future upgraded size.
† Extended run times available with optional external matching battery cabinets.
§ 8-18 kVA units accept optional 208V 3-phase 4-wire plus ground input. Full load current shown is based on UPS operation in bypass mode. In bypass mode, the UPS draws single phase current from the source, regardless of single or 3-phase input configuration.
†† Full load current is the maximum amperage that each phase conductor can carry (L1-L2, L1-N, or L2-N), while not exceeding the total watt or kVA rating of the system.



INTRODUCTION

The Liebert UPStation S™ Uninterruptible power supply (UPS) system protects valuable equipment, data, and processes from utility power disturbances. The high-performance, on-line, microprocessor-controlled design ensures clean, regulated, sinewave power to loads regardless of utility power fluctuations. An internal battery provides power to loads during utility power outages.

This highly intelligent UPS alerts you to unusual circumstances, or configure the UPS to serve as a source of information and a power control base for specific applications. Programmable parameters, computer interfaces, and several network control features (remote status/control, Power Management, event logging, and others) provide maximum application flexibility.

Features

- Input power factor correction (PFC) makes optimal use of utility power.
- Input current total harmonic distortion (THD) of less than 5% minimizes noise on the branch circuit and reduces neutral currents.
- Power Output Distribution (unit) facilitates UPS repair or battery replacement without disrupting power to the load on 3.5 - 6 kVA units
- Temperature-compensated battery recharge for longer battery life.
- Programmable voltage and frequency.
- Tower configuration with small footprint.
- Two-phase pulse width modulated (PWM) inverter with isolated neutral.
- UL 1778 and CSA 22.2 listed for user safety.

Standard System Components

- Integral Battery
- LCD Display for comprehensive user indications and controls
- Audible Alarm
- Remote Emergency Power Off (REPO) capability
- Auto-Restart capability
- Automatic Bypass

Optional System Components

- Communication Interfaces: SiteNet 1 Shutdown Kits, SiteNet 2 Power Surveillance, and SiteNet SNMP
- External battery cabinets
- Power Management for individual load control.

UNLOADING THE UPS

Refer to the figures below:

1. Remove shipping bands (A) and edge protectors (B).
 2. Remove polybag and box.
 3. Remove bracket mounting bolts (C) from pallet.
 4. Knock out shims (D) with hammer and screwdriver.
 5. Thread leveling feet (E) flush with unit bottom.
 6. Remove front pallet hex bolts (F). Remove the front skid (G).
 7. Slowly tilt the unit forward and roll it off the pallet.
- CAUTION:** The units are heavy. Use at least two people for this step.

Unbolt shipping brackets (H) from unit. Inspect unit. Verify model number and check for damage. Make sure UPS Input, Output, and Battery circuit breakers are Open (OFF).

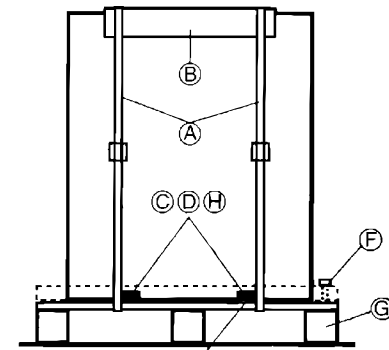

FIGURE #1
Side View with
Mounting Bracket
Detail

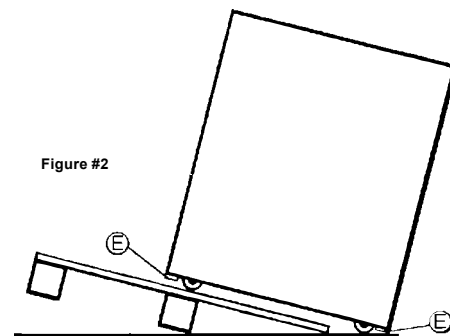
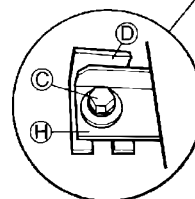

Figure #2

INSTALLATION

Read **Operation** section to understand user controls and displayed messages before beginning.

Operate UPS in a clean, controlled environment with adequate airflow. Exposure to excessive dirt or dust adversely affects UPS operation.

Internal fans cool the UPS. The unit intakes air at the front and exhausts it out the rear. Allow at least one foot of space around UPS for air circulation. Operate UPS within specified temperature and humidity limits.

Allow only authorized personnel to service UPS. Allow a minimum of 3 feet access on both sides for rigid conduit installations. Units that can be rolled forward for side service access require no side access in their normal position. Manual UPS operation and connection to UPS receptacles requires rear access.

3.5-6 kVA Connections

See the figure to the right for connection locations.

CAUTION: A qualified electrician must review and approve customer-supplied wiring, circuit breaker(s), power outlet, and intended loads. Ensure correct line, neutral, and ground connections, and that phase rotation is phase A leads phase B. See *Site Planning Data and Table NEC Wire Specifications in the Appendix.*

3.5 - 6 kVA Liebert UPStation S™ systems include the UPS and the AC unit. The unit provides connection to both utility power and UPS output power through the use of a simple Maintenance Bypass Switch. See the **Operation section for instructions on Maintenance Bypass Switch use.**

Input

The input power cord includes a NEMA L14-30 plug. The cord is six feet long and rated for 30 Amps. Customer supplied wiring must include an L14-30 receptacle and a 30 Amp circuit breaker.

Output

The POD contains the output receptacles.

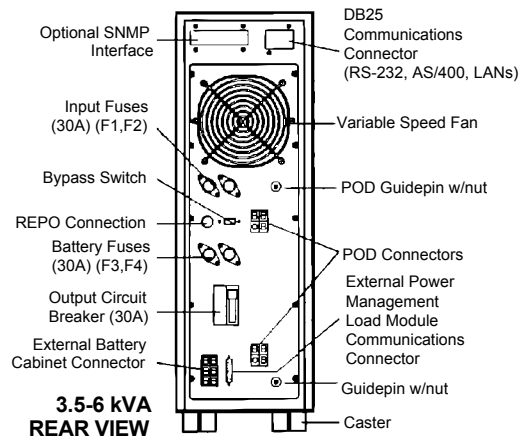

3.5-6 kVA Single Line Diagram

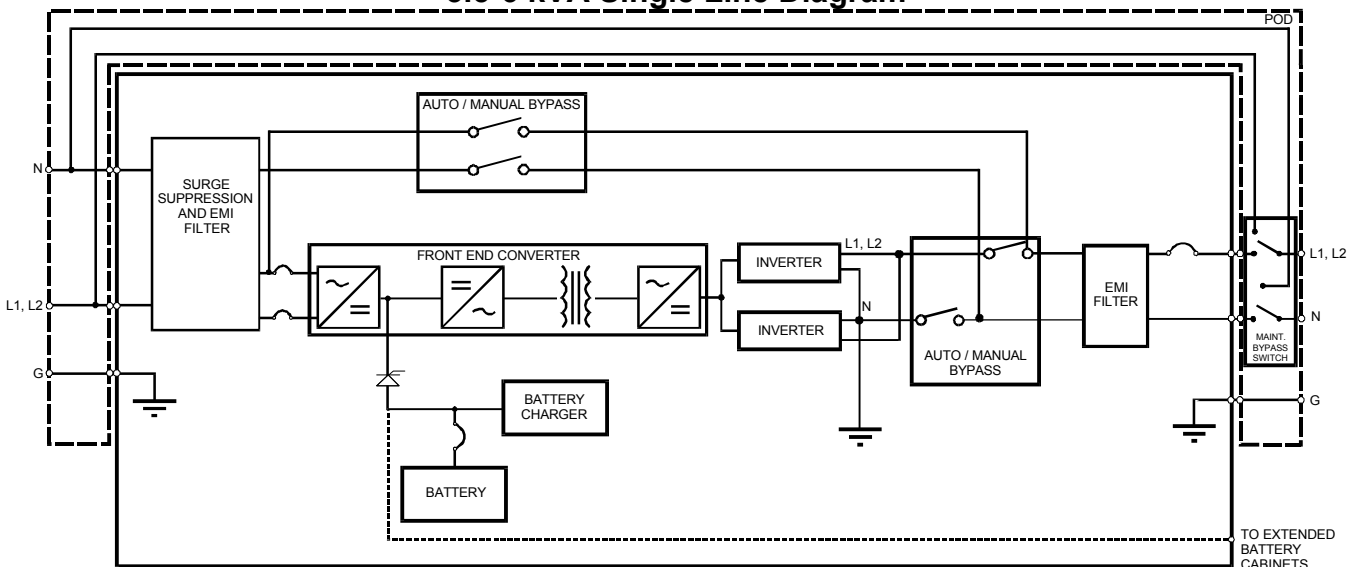

3.5-6 kVA Start-up Checklist

1. Remove POD from box. Set aside the two UPS battery fuses inside the user manual packet for later installation.

Steps 2 – 4 apply to UPS Hardwire Input / Output connections **ONLY**.
For standard plug connections, skip to step 5.

2. Note conduit knockouts on unit side. Remove the four screws securing the terminal block access cover.
3. Wire UPS input and/or output per NEC (NFPA 70) and all applicable local codes. Use 75 degrees C copper wire. See Site Planning Data and Table NEC Wire Specifications in the Appendix. Note that terminations used for an L-L-N-G system differ from those used for an L-N-G system as indicated by the terminal block labels below.

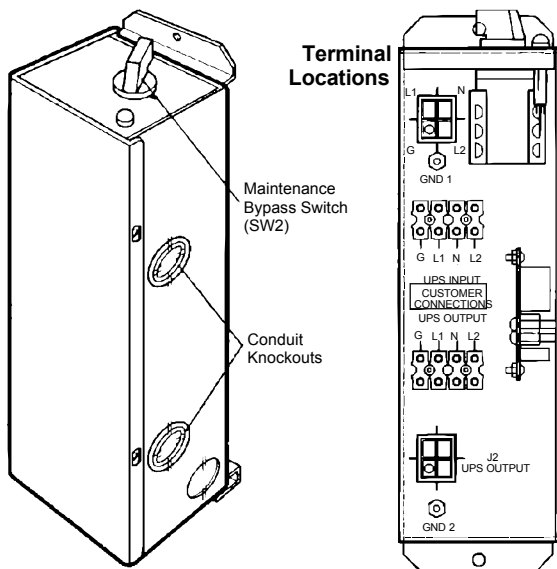

4. Reassemble the POD.
5. With UPS OFF, remove hex nuts on the two guide pins on the rear of the UPS.
6. While holding the unit with the Maintenance Bypass Switch on the top, guide the unit so that the UPS guidepins insert in the holes at the top and bottom. As the guidepins insert, ensure that the two sets of connectors align. Once all the connector pins make contact, push the unit onto the UPS until it is in contact with the back of the UPS.

CAUTION: If connector pins do not align, DO NOT force the unit onto the UPS. It may break the pins. Instead, try to reinstall the unit.

7. Look at the connection from the side. There should be no gap between the unit connectors and the UPS connectors. If there is, push the unit further until no

gap exists. Thread hex nuts back onto guide pins with a 7/16" wrench.

8. Verify the Maintenance Bypass Switch (switch SW2 on the unit) is in the "UPS" position
9. Turn off all UPS-supported loads and plug them into the POD.
10. Install the two battery fuses (F3 and F4). The second fuse completes a circuit. The spark is a normal indication.
11. Roll unit to final position. Allow at least one foot of rear clearance. Adjust leveling feet.
12. Plug unit power cord into the wall outlet.
13. Turn ON customer-supplied wall outlet circuit breaker to supply power to UPS control circuits. The fan and the LCD display activate.
14. The LCD display prompts you to review and accept default settings (see page 11) or configure the UPS for your application.
15. After configuration, automatic self-tests begin. If self-tests are OK, the Close Breaker then Press ON message appears and an alarm sounds. Press Alarm Silence Button to silence the alarm. If any other message appears, contact Liebert at 1-800-222-5877.
16. Turn ON Output Circuit Breaker on back of UPS by turning it OFF, then ON again to reset it. Press the front panel ON button. The UPS tests the inverter and displays the Normal Operation message.
17. Green light on unit indicates power available for loads and normal UPS operation.
18. Turn on each critical load one at a time. The UPS provides filtered, regulated power to protect valuable processes and data.

Unit Installation

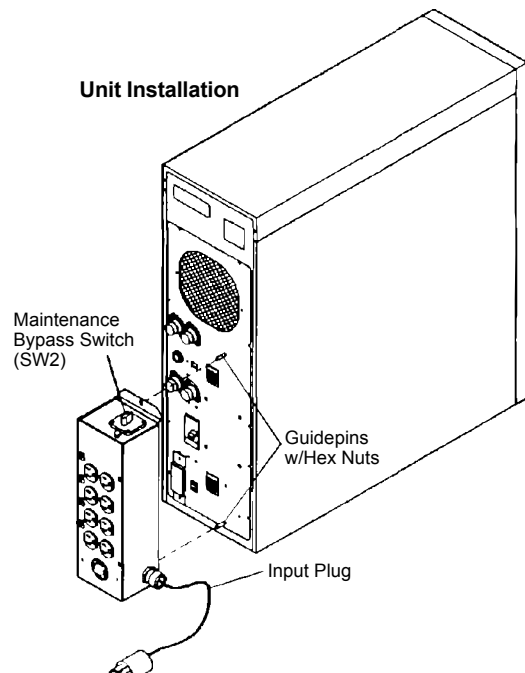

8-18 kVA Connections

CAUTION: A qualified electrician must review and approve the customer-supplied wiring, circuit breaker(s), power outlet, and intended loads. Ensure correct line, neutral, and ground connections, and that phase rotation is phase A leads phase B (leads phase C, if third phase is used). See Table #5 in the Appendix & Site Planning Data.

See Table #1 to the right and the figures on the following pages for terminal details and block diagrams of UPS with both single and optional dual input. Use 75 degrees C copper wire in compliance with the NEC (NFPA 70) and all applicable local codes.

Remove conduit-landing plates from UPS. Punch conduit holes in these plates for both input and output connections. Tighten wire connections according to unit torque specification labels and Table #1.

Input

The UPS accepts two-phase or three-phase power.

Output

8 - 12 kVA: Hardwire output power to a customer-supplied panelboard, or to optional distribution units. The Configurable Distribution unit (in conjunction with Load Modules) provides receptacle distribution. See Distribution in the Options section.

15 - 18 kVA: Hardwire output power to a customer-supplied panelboard.

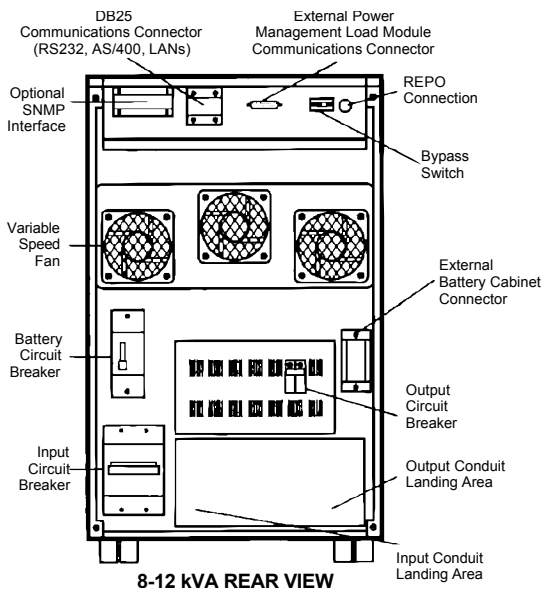
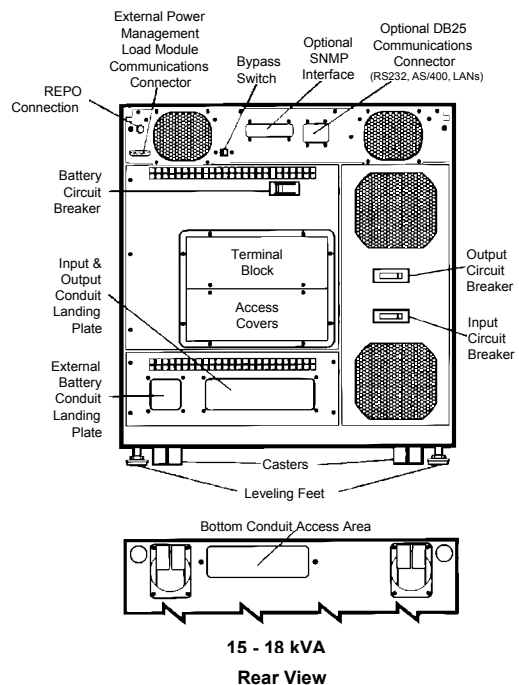

Table #1 – Compression Field Connections		
Connection	Wire Size Range (AWG)	Torque (lb.in)
8 –12 kVA Liebert UPStation S™		
AC Input	#14 - #2.0	#2.0 - #6 = 45 #8 = 40 #10 - #14 = 35
Optional Dual AC Input		
AC Output		
Ground and GEC	#14 - #6	
15 - 18 kVA Liebert UPStation S™		
AC Input	#14 - #2/0	#2.0 - #6 = 45 #8 = 40 ##10 - #14 = 35
Optional Dual AC Input		
AC Output		
Optional Ext. Battery Cabinet		
Ground and GEC		
1581EBD External Battery Cabinet		
Input DC and Ground	#14 - #2/0	#2.0 - #6 = 120 #8 = 40 #10 - #14 = 35

NOTES:

- 8 – 18 kVA systems require a local Grounding Electrode per NEC 250.
- Minimum size grounding conductors per NEC. Parity sized ground conductors recommended. Size Neutral conductors for full capacity per NEC.
- Refer to NEC Article 250 and local codes for proper wire sizing and grounding practices.
- UPS Output is a separately derived source when operating on inverter. Output Neutral is bonded to equipment ground internal to the UPS.



8 - 18 kVA Start-Up Checklist

1. Open (turn OFF) UPS Output Circuit Breaker.
2. Open (turn OFF) customer supplied distribution circuit breakers.
3. Turn OFF critical loads and plug them into output distribution units or customer-supplied distribution.
4. Turn ON battery circuit breaker on rear of UPS.
5. Roll unit to final position. If using flexible conduit for power connections, allow at least 18 inches of clearance around the UPS with enough conduit to roll UPS 3 feet from wall. If using rigid conduit, allow at least 3 feet of clearance around the UPS. Adjust leveling feet.
6. Close (turn ON) customer-supplied circuit breaker that supplies power to the UPS.
7. Close (turn ON) the UPS Input circuit breaker to supply power to UPS control circuits. The fans and LCD display activate.
8. The LCD display prompts you to review and accept default settings or configure the UPS for your application. See page 11 for default settings.
9. After configuration, automatic self-tests begin. If self-tests are OK, a horn sounds and the "Close Breaker then Press ON" message appears. If any other message appears, contact Liebert at 1-800-222-5877.
10. Close (turn ON) Output circuit breaker on back of UPS and press the ON button.
11. The UPS tests the inverter and displays the Normal Operation message.
12. Close (turn ON) customer-supplied distribution circuit breakers.
13. Turn on each critical load one at a time. The UPS provides filtered, regulated power to protect valuable processes and data.

8-18kVA Single Line Diagram

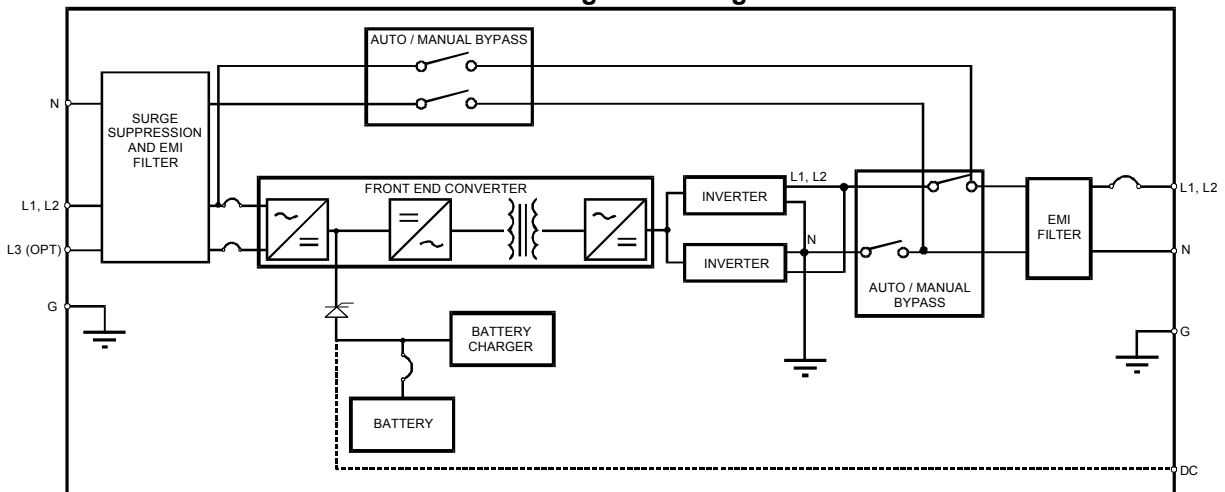

OPERATION

Control / Display Panel

The control panel includes tactile pads (dome buttons) and a menu-driven LCD (liquid crystal display). The display provides full metering, present status, and alarms, if any. See figure on right.

Control Buttons

ON Button - This button turns on the UPS inverter. It supplies power to the output if the Output Circuit Breaker is closed. The ON button also restarts the UPS after a manual shut-off.

OFF Button - Press this button twice to cause an orderly shutdown of the unit. The unit turns OFF all power to loads, including bypass, and disables Auto-Restart until the ON button is pressed. However, the display remains active and the batteries still recharge. Pressing the button only once causes a return to normal operation in a few seconds. This control feature helps avoid accidental shutdowns.

Note: If you press the OFF button a third time, a display message prompts you to press it a fourth time which opens the Output Circuit Breaker at the rear.

Alarm Silence Button - This button silences alarms. The alarm sounds if a new alarm occurs.

LCD Display

The menu-driven LCD display has four (4) lines of text (16 characters per line) on a screen to indicate status, alarms, metered conditions, and user selections. The display controls include four (4) buttons to view or select UPS conditions:

Left Arrow - Returns to previous screen or value

Right Arrow - Advances to next screen or value

Enter - Selects a menu, display, or value and enters selected values into the control program

Escape - Cancels selections. It returns values to original settings and the display to the main menu.

The LCD panel displays messages and operating parameters. It usually displays a Normal Operation screen (see figure on right) which includes date, time, and a prompt on the help line to select the Main Menu. Alarms or faults displace the Normal Operation screen.

The user screens are organized in a multi-level menu system (see page 13). Select a choice with the keys below the screen. The Enter key moves the cursor to the next lower menu level. The Escape key returns the cursor to the previous menu. Use the Left and Right keys to scroll through available options and to select user-programmable values. The cursor indicates which value is active. Press Enter to record the value after each selection.

Initial Start-Up

At initial start-up, the LCD display prompts the user to review or change the configuration. The initial configuration menu allows the following selections:

Review Configuration, Change Settings, UPS Meters, and Accept Settings.

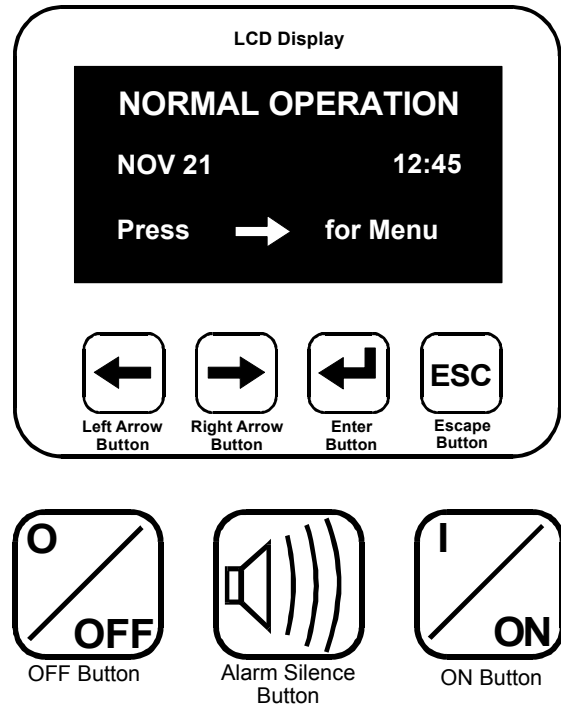

After reviewing or changing the output configuration, then accepting it, start-up self tests begin. The selected configuration is stored in control memory even with no power to the UPS.

Self tests begin immediately if power is applied after initial start-up. Configuration review is optional.

The unit will not repeat most self tests when turned OFF then ON because power is not removed from control logic. Upon turning it ON, the unit tests the inverter. To start unit, close the Output Circuit Breaker.

User Menus - The Main Menu allows these options:

- **Configuration**
- **UPS Meters**
- **Event Log**
- **Test Options**
- **Power Management**

The **Configuration** option allows review or change of the following settings:

<u>Configuration Setting</u>	<u>Default Value</u>
Input Voltage	208/120 VAC
Input Frequency	60 Hz
Output Voltage	208/120 VAC
Output Frequency	60 Hz
Low Battery Warning Time	2 Minutes
Auto Battery Test	Enabled (5 wks)
Total UPS Runtime	0 Hrs
Input Wiring	L1-L2-N-G
Output Wiring	L1-L2-N-G
Time and Date	Present
Modem Mode	(see Options)
Horn Volume	16 (mid-range)
Screen Contrast	16 (mid-range)
Battery Charger Mode	Standard
Slew Rate	1.0 Hz/Sec
Input Frequency Sync Range	1.0 Hz
Start Up Mode	Auto-Restart
Password Protection	Disabled
Password	AAAAAAA
UPS ON(1)/OFF(0)	(remote use)
Transfer UPS	(remote use)
Battery installed on	(Date)

Table #2 Factory Default Settings

NOTE: To change input or output voltage, frequency, or wiring, push the OFF button twice. Though the input is connected and the display is active, there is no output to the loads after pressing OFF twice. Other changes may be made during UPS operation.

The **UPS Meters** option allows review of the following UPS meters:

Load % kVA; A and B Phase
Input A-Phase; volts and amps
Input B-Phase; volts and amps
Bypass A-Phase; volts
Bypass B-Phase; volts
Output A-Phase; volts and amps
Output B-Phase; volts and amps
DC Bus; volts and amps
Frequency; input and output
Temperature; inside unit
Inverter Wattage; A and B Phase

The **Event Log** option allows review of the Alarm History log and the Input Disturbances log. The **Test Options** option allows a Screen Test (Enter then ESC) and a Battery Test (Enter begins a 30 second test) **NOTE:** See the following page for a complete menu tree. See the **Options** section for more information about Power Management.

LCD MENU TREE

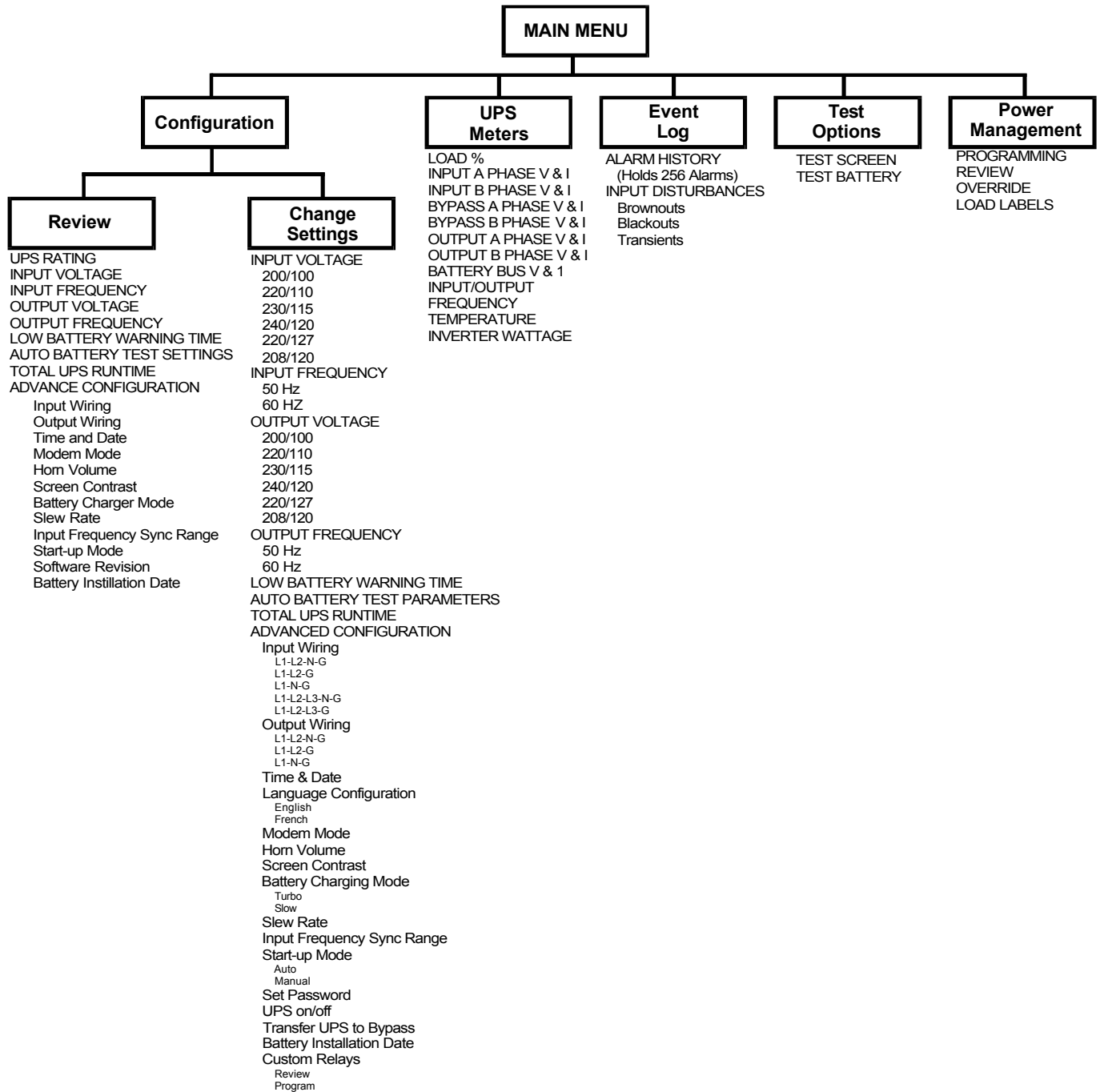

System Start-Up

Manual Restart after Manual Off

If Manual Restart has been selected (rather than Auto-Restart) and someone has turned the unit off, the Output Circuit Breaker will probably be closed. Just press the ON button to turn on the UPS inverter.

Auto-Restart

The factory enables this feature. The UPS automatically restarts and supplies power to the load after battery depletion. The UPS supplies power to the load as soon as utility service is restored.

Turning the UPS OFF disables Auto-Restart until the ON button is pressed.

Manual Restart after Low Battery Shutdown or REPO

Manual Restart (instead of Auto-Restart) opens the Output Circuit Breaker upon battery depletion during a power outage. Pressing the customer-supplied REPO switch also opens the Output Circuit Breaker. To manually restart the UPS, close the Output Circuit Breaker (turn it OFF, then ON to reset breaker). When the "Press ON to start system..." message appears, press the ON button.

Normal Operation

When the utility power is available and within acceptable limits, the unit supplies filtered and regulated power to the load through the inverter. The battery charger maintains a charge on the battery.

During normal operation, the LCD display informs you of UPS status. The display indicates when the UPS transfers the load to or from bypass (if available), when the load is On Battery, and when alarms or faults occur.

See the alarm chart in the Appendix for alarm message meanings and corrective actions.

Battery Operation

On Battery

During low input voltage, the battery supplements inverter power. During a utility power failure, the battery provides all power required for normal operation. A fully charged battery provides at least 10 minutes of output power. More battery power is available if your system includes an optional external battery cabinet (see **Options**). Less load increases the battery back-up time. If your UPS supports several computer systems, turning some of them off allows others to run longer. **Battery Run Time** curves in the Appendix show performance of the internal battery and external battery cabinets.

NOTE: If utility power remains off, perform an orderly shutdown of the critical load before exhausting the battery. If utility power returns during battery operation, normal operation resumes and battery recharging begins.

Battery Recharge

Upon return of acceptable utility power after battery operation, the battery charger begins to charge the batteries. Battery charging stops upon pressing the OFF button four times or activating the REPO.

The battery charger compensates for battery temperature. In addition, the charger has two recharge rates, user-selectable through the LCD display. The "turbo" rate recharges batteries to **95%** capacity within 10 times the discharge duration. The "standard" rate recharges batteries to **95%** capacity within 20 times the discharge duration. Select the "standard" factory default setting rate if your utility system has frequent (weekly) blackouts.

With "turbo" mode enabled, the microprocessor determines how often to use the fast recharge rate, in order to optimize battery life.

Bypass Operation

The bypass provides an alternate path for power to the critical load. On bypass, utility power feeds directly to the load.

Auto-Bypass

Upon overload or inverter failure, the UPS automatically transfers to (and from) bypass. During an overload, the UPS attempts to retransfer from bypass to the inverter up to 15 times within a 20-minute period. If the overload prohibits retransfer after 20 minutes, the unit remains on bypass.

Manual Bypass

Manually select the bypass power to the critical load by operating the bypass switch on the back of the unit. When

activated, the unit immediately transfers to bypass and turns OFF the inverter, PFC, and battery charger. The UPS remains in bypass until the switch is moved to the UPS position. The user may also initiate manual bypass via the LCD display or RS-232 remote communications.

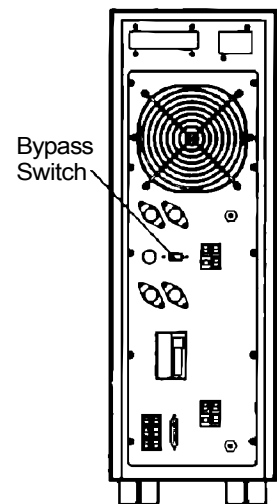

Maintenance Bypass Operation

on 3.5 - 6 kVA Units

The POD includes a Maintenance Bypass Switch that allows UPS removal for service or maintenance without interrupting power to the loads.

Transferring from UPS Operation to Maintenance Bypass Operation

1. Transfer UPS to manual bypass operation via switch SW1 on back of the UPS. The UPS beeps, indicating bypass operation. Press the Alarm Silence button to silence the beep.
2. With UPS in bypass, rotate the unit Maintenance Bypass Switch (SW2) to the "Maintenance Bypass" position.
3. Press the UPS OFF Button twice. Utility power now supports the load. Leave the POD mounted on the UPS. Allow only qualified service personnel to remove it. For UPS repair or maintenance, contact Liebert at 1-800-222-5877.

Transferring from Maintenance Bypass Operation to UPS Operation

1. Verify the UPS manual bypass switch (SW1) is in the "bypass" position, and the UPS output circuit breaker is ON. (Turn the circuit breaker OFF and then ON to reset it.)
2. Reattach unit following the instructions in the 3.5-6 kVA Startup Checklist.
3. UPS begins start-up and the manual bypass alarm sounds. Silence the alarm.
4. Set the UPS manual bypass switch (SW1) to the "UPS" position.
5. UPS display indicates "Start up test warning: check messages". Press the right arrow button. If "Load on Manual Bypass" appears, turn the UPS ON by pressing the ON button twice.
6. Wait for the UPS display to indicate "Normal Operation". Set unit Maintenance Bypass switch (SW2) to the "UPS" position. UPS now supplies controlled power to the loads.

System Shutdown

Manual Off

Pressing the OFF button twice removes power to the load by turning off the inverter and opening the bypass. The Output Circuit Breaker remains closed, even though output power is unavailable.

Pressing the OFF button twice disables Auto-Restart until you press the ON button, but control logic and battery charging remain active.

NOTE: Pressing the OFF button a third time displays a message prompting you to press the OFF button a fourth time. Pressing it a fourth time opens the Output Circuit Breaker at the rear of the unit.

Remote Emergency Power Off

Each unit includes a connector to facilitate Remote Emergency Power Off (REPO) from a customer-supplied switch. An optional switch with 50 feet of cable is available. Activating Emergency Off opens the Output Circuit Breaker and disables battery recharge.

UPS Alarms

See the alarm chart in the Appendix for alarm message meanings and corrective actions. Perform the corrective action described for a specific alarm. For assistance, contact Liebert at 1-800-222-5877.

OPTIONS

Contact your Liebert UPS distributor for option availability and ordering information.

Distribution

Configurable Distribution (CD)

An optional enclosure hardwires to 3.5 - 12 kVA units and accommodates up to eight Standard or Power Management Load Modules. It may be wall or floor-mounted and includes a 70 Amp circuit breaker. Refer to drawings below.

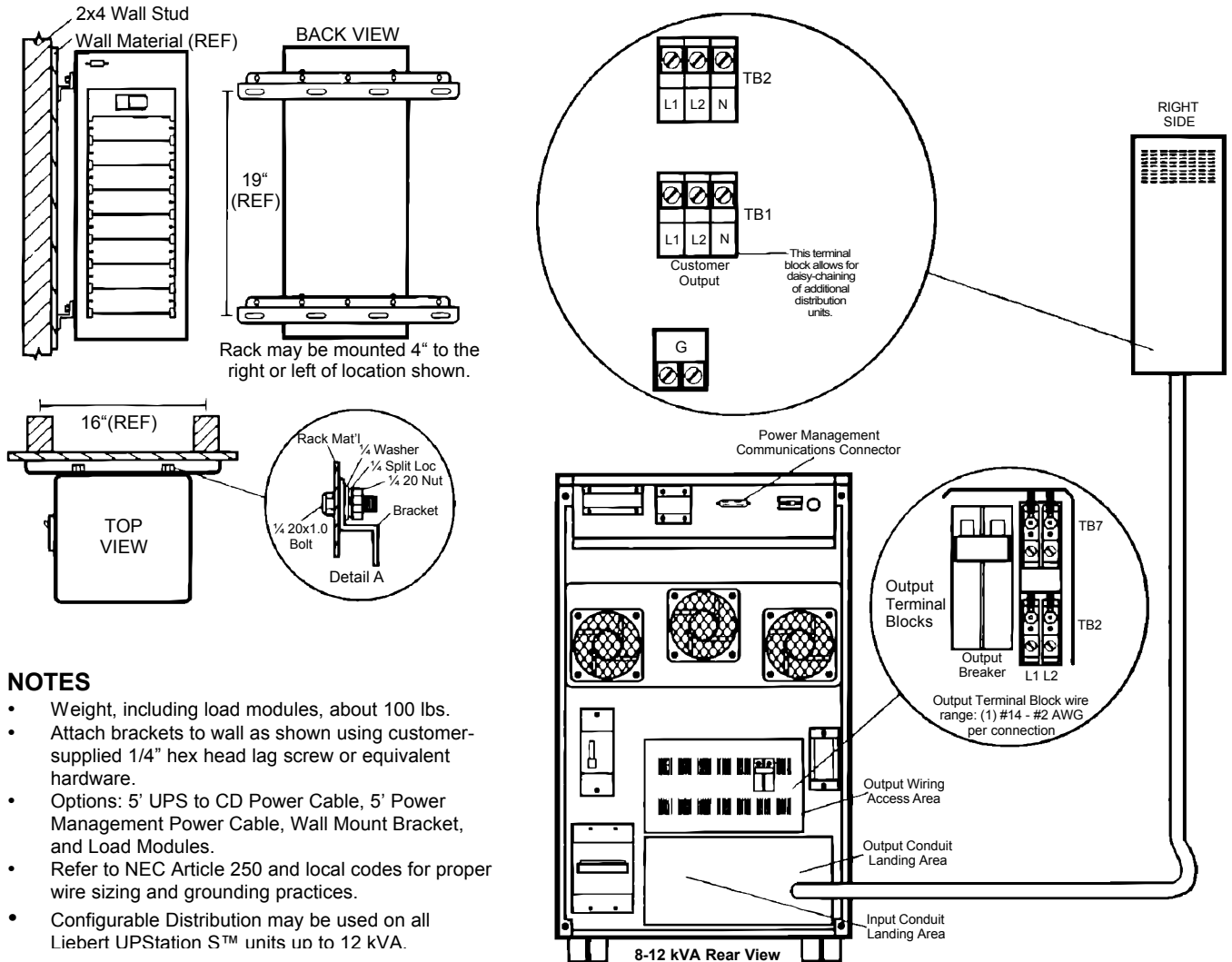

NOTES

- Weight, including load modules, about 100 lbs.
- Attach brackets to wall as shown using customer-supplied 1/4" hex head lag screw or equivalent hardware.
- Options: 5' UPS to CD Power Cable, 5' Power Management Power Cable, Wall Mount Bracket, and Load Modules.
- Refer to NEC Article 250 and local codes for proper wire sizing and grounding practices.
- Configurable Distribution may be used on all Liebert UPStation S™ units up to 12 kVA.

Load Modules

Load Modules for 3.5 to 12 kVA units offer a variety of power receptacles when used in conjunction with the Configurable Distribution. Each Load Module includes:

1. Circuit Breaker
2. Green output receptacle(s) power indicator
3. 1 or 2 Output Receptacles.

Hard Wire (terminal block) Load Modules provide a knockout to attach flexible conduit (see drawings to the right). Use no more than three feet of conduit to avoid attachment points required by national and local codes. Terminal compression lugs accept wire size 42 to #14 AWG. Select wire size based on UL 1778 and NEC. See **Table #3** below for circuit breaker provided. Tighten each connection based on wire size as follows: 10 to 14 AWG to 35 lb.-in., 8 AWG to 40 lb.-in., 4-6 AWG to 45 lb.-in., 2-3 AWG to 50 lb.-in.

See **Power Management** for details on Power Management Load Modules.

TABLE #3 – LOAD MODULES		
Receptacle	Voltage (configuration)	Circuit Breaker
5-15R2	120 (L-N-G)	15 A, 2 Pole
L5-15R1	120 (L-N-G)	15A, 1 Pole
L6-15R1	208 or 240 (L-L-G)	15 A, 2 Pole
5-20R2	120 (L-N-G)	20 A, 2 Pole
L5-20R1	120 (L-N-G)	20 A, 1 Pole
L6-20R1	208 or 240 (L-L-G)	20A, 2 Pole
L14-30R1	208/120 or 240/120 (L-L-N-G)	20A, 2 Pole
6-15R1	208 or 240 (L-L-G)	15A, 2 Pole
L5-30R1	120 (L-N-G)	30 A, 1 Pole
L6-30R1	208 or 240 (L-L-G)	30 A, 2 Pole
L14-30R1	208/120 or 240/120 (L-L-N-G)	30A, 2 Pole
Hardwire (15 A)	208/120 or 240/120 (L-L-N-G)	15A, 2 Pole
Hardwire (20 A)	208/120 or 240.120 (L-L-N-G)	20 A, 2 Pole

Standard Load Module

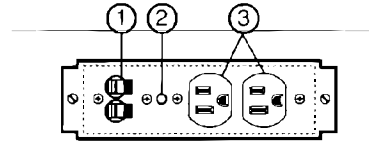

Hardwire Load Module

Remove screw to open module cover for terminal block access.

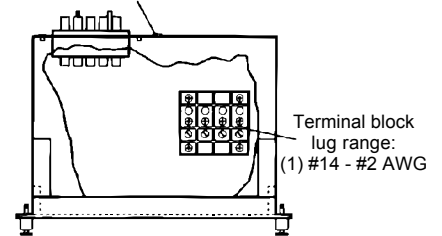

Conduit entry knockout: .5", .75", or 1.0" diameter

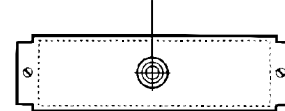

HARDWIRE NOTES

- Use flexible metal or liquid-tight metal conduit only.
- For conduit lengths longer than three feet, refer to NEC article 350-4 or 351-4 for securing conduit.
- Use knockouts for conduit attachment. DO NOT drill into UPS or load module.
- Use wire sized in accordance with NEC 310-16 and the output breaker amperage.

Maintenance Bypass 8 - 18kVA

The Liebert UPStation S™ Maintenance Bypass Cabinet allows the customer to completely isolate the UPS for repair and/or preventive maintenance. A rotary switch provides a make-before-break system that enables a transfer to and from maintenance bypass without interruption to the load.

There are two sizes available; the VM12000 series for the 8-12 kVA units and the VM18000 series for the 15 -18 kVA units.

Weights/Dimensions

The maintenance bypass cabinet is a wall-mount system. Dimensions and weights depend on the KVA rating and options installed. Use the following table to determine the weight of your maintenance bypass. Dimensions can be found on page 20.

Approximate Weights in Pounds		
Model Number	125	175
VM12000		
VM18000		

Standard Features

- A locking handle prevents unauthorized access.
- A holder for the User's Manual and any site documentation is provided on the inside cover of the door. This enables the customer to keep all documentation relating to their UPS and maintenance bypass with the unit.
- Auxiliary contacts, rated at 15 amps and 600 volts, are available if the customer requires remote monitoring of the maintenance bypass.
- Conduit knock-outs for power wiring and control wiring are prefabricated into the enclosure, allowing for top or bottom entrance.

Modes of Operation

There are three modes of operation on the maintenance bypass; On-Line, Test, and Maintenance Bypass. There are two major types of maintenance bypass cabinets and Liebert UPStation S™ units when referring to the one-line diagrams and power flows.

On-Line

When the rotary switch is placed in the On-Line position, contacts A and C are closed with contact B open. The standard Liebert UPStation S™ is powering the critical load as illustrated below.

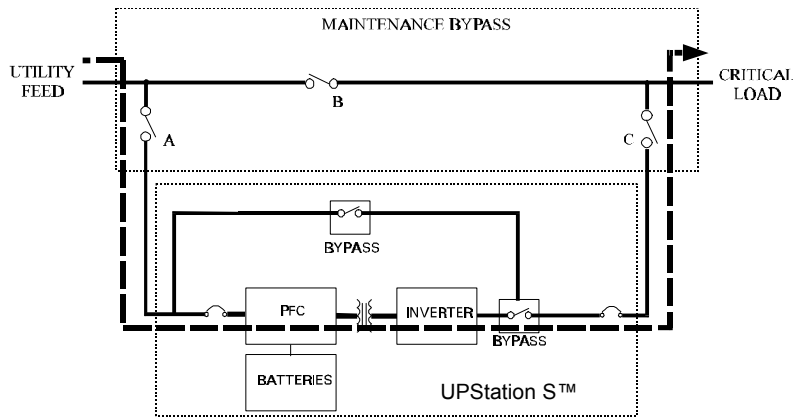

Test

When the rotary switch is placed in the Test position, contacts A and B are closed and C is open. The power for the load is now coming from the maintenance bypass source, as illustrated in below. The connection from the output of the UPS is open. Input power to the UPS is still available for testing and troubleshooting purposes.

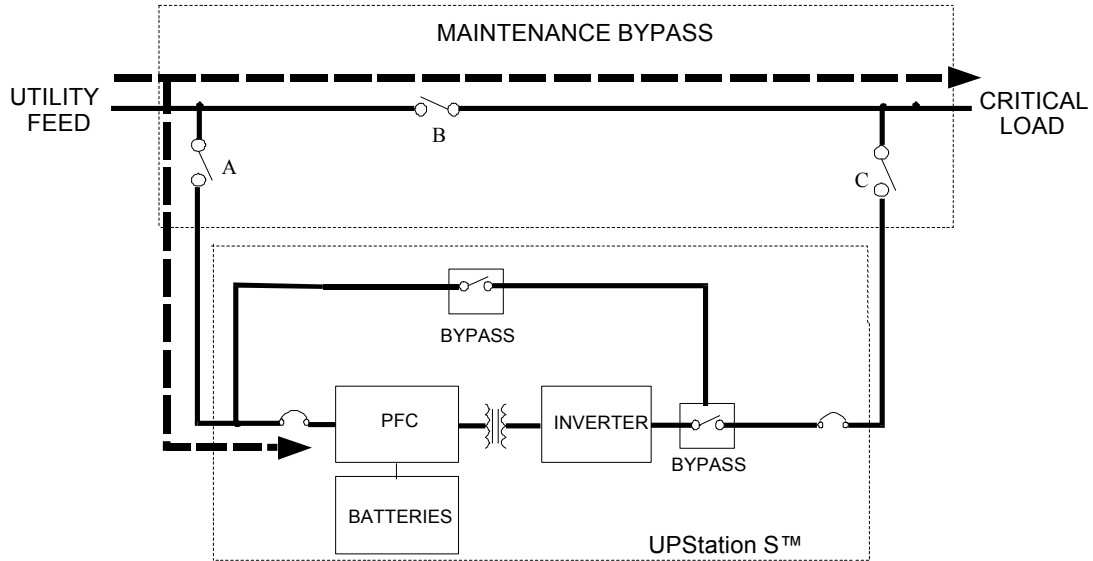

Maintenance

When the rotary switch is placed in the Maintenance position, contacts A and C are open and B is closed. The power for the load is coming from the maintenance bypass source, as illustrated below. The UPS is now completely isolated from the source as well as the critical load.

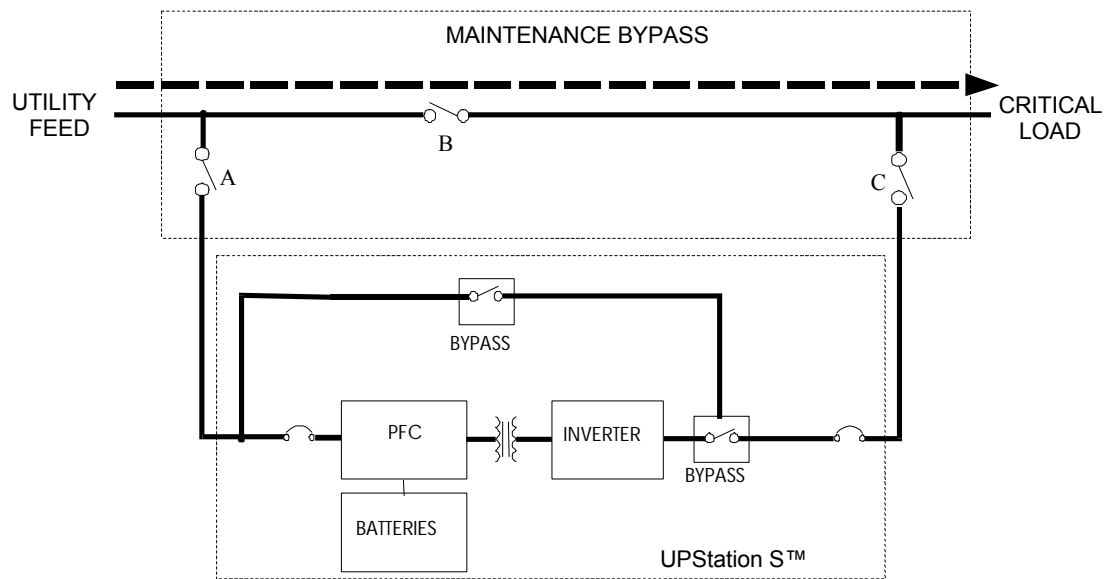

INSTALLATION

This section includes unloading, inspection, mounting and connections for the maintenance bypass cabinets. Reading this section in its entirety before you begin is a good preparation for your start-up.

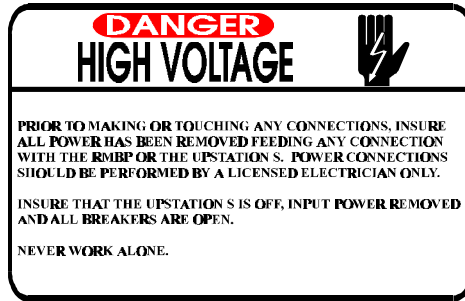

UNLOADING

The unit is shipped on a box that is banded down to a pallet. To unload the maintenance bypass cabinet:

- Remove the banding from the container
- Open box and remove maintenance bypass.
- Inspect for any damage to the unit. Report any damage to the shipping carrier and

complete a freight damage claim form. Insure that the system ordered is what was received prior to mounting.

Mounting

The Liebert UPStation S™ Maintenance Bypass Cabinet is designed for wall mount only. **Prior to installation, verify that the wall can support the weight of the bypass cabinet. Weights can be found on page 18.**

The dimensions required for mounting of the maintenance bypass are illustrated below. All dimensions are in inches.

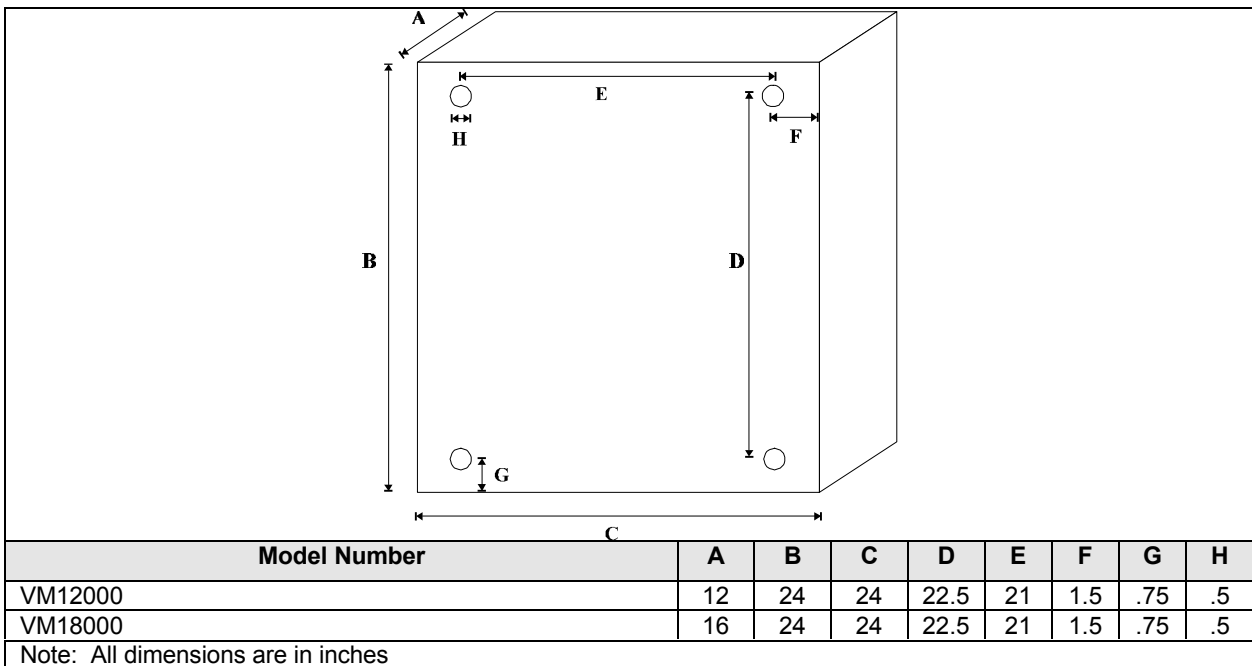

NOTICE

1. Input and Output Power wiring must be run in separate conduit.
2. Control and Power wiring must be run in separate conduit.
3. Wire and breaker sizing must be in accordance with NEC and local electrical codes.
4. RMBP units are designed to be mounted on the wall. Insure that wall can support weight prior to installation.
5. The UPStation S must have an internal bypass for system to operate according to specifications.

The 8-18 kVA Liebert UPStation S™ allows the customer to connect a three-phase input if desired. The only benefit to connecting a third phase is to balance a three-phase feed transformer.

The 8-18 kVA Liebert UPStation S™ has two basic connections; UPS Input and UPS Output. Below is an

illustration of how the system will look electrically once the installation is complete.

Connections between the maintenance bypass and the UPS must be run in separate conduit. Due to the clearance requirements for service on the UPS, it is recommended that flexible conduit be used.

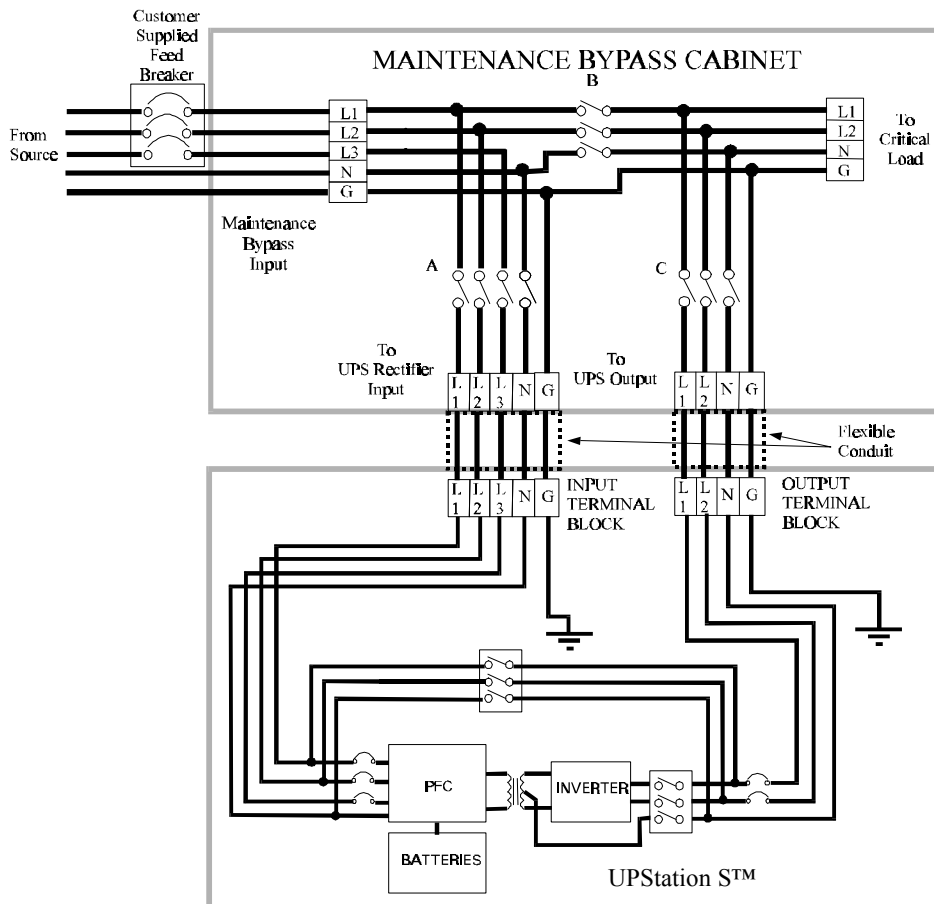

Input and output terminal blocks are provided on the back of the 8-12 kVA Liebert UPStation S™ as illustrated below. Conduit can be landed on the rear or bottom of the UPS. Note that side, rear, front and top access is required for service on all Liebert UPStation S™ product lines.

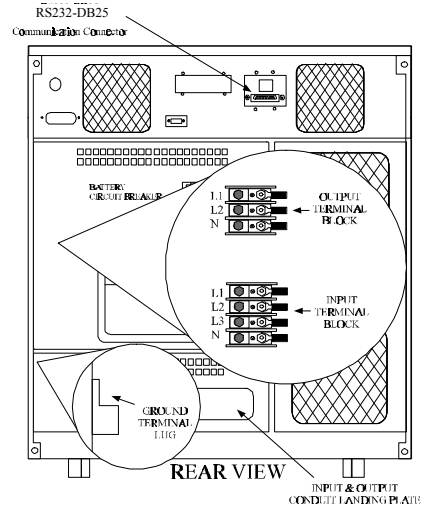
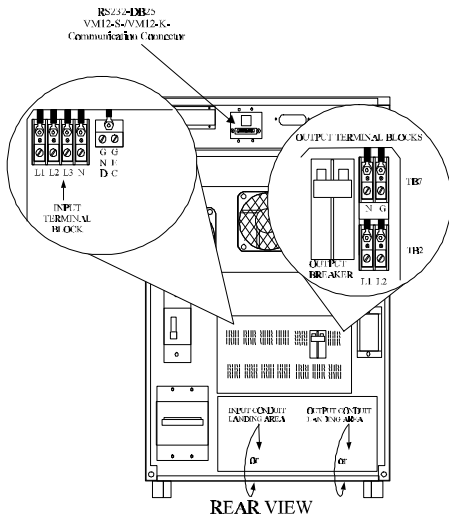

Input and output terminal blocks are provided on the back of the 18 kVA UPS as illustrated above right. Conduit can be landed on the rear or bottom of the UPS. Note that side, rear front and top access is required for service on all Liebert UPStation S™ product lines.

8-18 kVA Maintenance Bypass Connections

The 1512MBC and the 1518MBC maintenance bypass have four basic connections: maintenance bypass input, to UPS rectifier input, to UPS output and to critical load.

- The input to the maintenance bypass comes from the utility source to the system. There must be a breaker feeding the system. Size the input feed breaker and

wiring as per NEC. The total current into the maintenance bypass should not exceed 46A for the 8 kVA, 56A for the 10 kVA, 66A for the 12 kVA and 94.4A for the 18 kVA

- It is recommended that the site wiring and overcurrent protection be sized initially for 12 kVA if the UPS is an 8 or 10 kVA module.
- Wire size range for TB5 terminal block is #10 to #22 AWG. Wire size range for TB1 through TB4 is #4 to #8 AWG. Terminal blocks have box type lug connections with slotted screw.

OPERATION

The best way to initially test and start-up the unit is to do it without a load.



Initial System Start-up

- Set the maintenance bypass rotary switch to the maintenance position. Set the meter switch to the Input L1-L2 position (units with meters)
 - Locate customer's critical load breakers. Verify that all load breakers are in the off position. Close customer supplied feed breaker. Power is now flowing through the maintenance bypass as illustrated on page 19.
 - Verify the L1-L2, L1-N and L2-N input voltages, with a digital voltmeter (DVM), are as per the customer's specifications. **The UPS and maintenance bypass input and output voltages and frequency must be the same for the system to operate according to specifications.**
 - Rotate the bypass switch to the Test position. Power is now flowing through the maintenance bypass as illustrated on page 19.
 - Close the UPS battery breaker and input breaker, in that order. The UPS should now be going through its normal testing and start-up procedure. Follow UPS LCD screen instructions.
 - After the output breaker is closed and the ON button is pressed, the unit should return to the Normal Operation screen. Proceed to the meter screen on the UPS LCD. Verify that the output voltage and frequency is the same as the input voltage and frequency.
- With a DVM, verify that there is no voltage difference between the following points in the bypass cabinet:
 - TB1 L1 to TB3 L1
 - TB1 L2 to TB3 L2
 - Return the UPS LCD to the Normal Operation screen. Transfer the UPS to bypass by placing the bypass/UPS switch on the back of the unit in the bypass position.
 - Again with a DVM, verify that there is no voltage difference between the following points in the bypass cabinet:
 - TB1 L1 to TB3 L1
 - TB1 L2 to TB3 L2
 - Rotate the bypass switch to the On-Line position. Transfer the Liebert UPStation S™ to the UPS mode by placing the bypass/UPS switch on the back of the unit in the UPS position and pressing the ON button on the front of the unit. Power is now flowing through the maintenance bypass as illustrated on page 18.
 - The bypass switch is operating according to specifications if no problems occurred during the previous start-up steps.
 - Transfer the UPS to bypass by placing the bypass/UPS switch on the back of the unit in the bypass position. Verify the L1-L2, L1-N and L2-N output voltages, with a DVM, are as per the customer's specifications.
 - The customer may now bring up their connected critical loads. **Always energize the load on bypass, either UPS internal bypass or maintenance bypass.**
 - After the load is up and operating, the UPS may now be transferred on-line. Transfer the Liebert UPStation S™ to the UPS mode by placing the bypass/UPS switch on the back of the unit in the UPS position and pressing the ON button on the front of the unit.
 - Power is now flowing through the maintenance bypass as illustrated on page 18. The load is protected by UPS power.

Transfer to Maintenance Bypass from On-Line

- Prior to transferring the maintenance bypass to the bypass mode, the UPS must be in bypass. Verify that the UPS does not have a bypass out-of-sync or bypass voltage out-of-tolerance alarm prior to transferring.
- If no alarms are present, transfer the UPS to bypass by placing the bypass/UPS switch on the back of the UPS in the bypass position. Verify the L1-L2, L1-N and L2-N output voltages, with a DVM, are as per the customers specifications.
- Rotate the maintenance bypass switch counter-clockwise to the test position. Open the UPS output breaker and silence the alarm. **Power is still being powered to the input of the UPS in the test position.**
- Continue rotating the maintenance bypass switch counter-clockwise to the maintenance position. The UPS should now shut off and input power has been removed. Open the input, output and battery breaker prior to servicing the unit.

Transfer to Test from Maintenance Bypass

- After preventive maintenance or repairs have been performed, it is important to test the UPS prior to placing it on-line. Please use the following steps to test the UPS without transferring on-line.
- Close the Battery breaker on the UPS. Place the bypass/UPS switch on the back of the unit in the UPS position.
- Rotate the bypass switch on the maintenance bypass clockwise to the Test position. Close the input breaker on the UPS.

- The UPS should now be going through its normal testing and start-up procedure. Follow the LCD screen instructions.
- After the output breaker is closed and the ON button is pressed, the unit should return to the Normal Operation screen. Proceed to the meter screen on the LCD. Verify that meters are within operating specifications.
- Return the LCD to the Normal Operation screen. Transfer the UPS to bypass by placing the bypass/UPS switch on the back of the unit in the bypass position.

Transfer to On-Line from Test

- Always verify that the UPS is in the bypass mode prior to transfer to On-Line position. Rotate the bypass switch to the On-Line position.
- The customer may now bring up their connected critical loads. **Always energize the load on bypass, either UPS internal bypass or maintenance bypass.**
- After the load is up and operating, the UPS may now be transferred on-line. Transfer the UPS to the UPS mode by placing the bypass/UPS switch on the back of the unit in the UPS position and pressing the ON button on the front of the unit.

TROUBLESHOOTING/WARRANTY

Troubleshooting

Troubleshooting should only be performed by a trained engineer authorized by. If you cannot resolve a problem, consult Liebert immediately at 1-800-222-5877. Do not continue to use the maintenance bypass cabinet if it is not performing according to specifications.

POWER MANAGEMENT

Use Power Management to program power to individual loads to turn OFF or ON at specific times or as a result of specific events. Only Load Modules with Power Management circuitry respond to Power Management programming.

Power Management enables you to selectively turn programmable Load Modules (receptacles) off and on to conserve energy, extend battery time, or control network devices based on:

- A programmed schedule
- Events such as utility power failure, battery time left, utility restored, UPS on bypass, and others
- Real time control (manual override), including rebooting the load

Other features include load labeling, programmable delay for each action, warning displays, and linking outputs so if one load module turns OFF (or ON) another one will also. A manual override is also available (force off, force on, or reboot).

Read these instructions entirely before programming UPS. After reading these instructions, decide on a program schedule. Make a chart of needed program steps. Include scheduled events (day and time) as well as conditions such as utility failure, battery time left, and utility restored.

Program entries must be made in pairs. Program an output to turn both OFF and back ON at certain times or events. This pairing concept provides program closure for each load. Example: An output programmed to turn OFF at utility failure must also be programmed to turn ON at utility restoration.

Getting Started

Access Power Management (option 5) from the main menu on the LCD display. The Power Management menu offers the following selections:

- **Programming**
- **Review**
- **Override**
- **Load Labels**

If your UPS has password protection, then all selections require a password with the exception of **Review**. Press the enter key to make a selection. **Use the right and left** arrow keys to display the available **selections when** a programmable item is flashing. **Press enter to store** your selection and flash the next **item**.

When reviewing the program, use the right arrow to display the next program step.

To program (or review), a program step box appears:

```
01)Load #0,0,0,0
Nothing Selected
ACTION DELAY(S)
Turn OFF load (00)
```

Power Management programs consist of four elements:

- Which Load Module
- What event triggers the Load Module
- Whether the Load Module turns ON or OFF
- The time delay between the event and the Load Module reaction

CAUTION: A program step becomes active as soon as it is entered. Therefore, program the scheduled ON action for each load before programming the OFF action. Otherwise, turn OFF critical loads.

To enter a program step (password may be required):

1. Select a Load Module

A. Press the enter key to flash the first load module selection. Press the right or left arrow key to review available selections (detailed below).

B. Press Enter key to store the first load modules selection and flash the second one. Make load selections as required for this program step. After making all load selections, the second line flashes.

2. Select an Event to Trigger the Load Module

When the "event" (second line) flashes, press the right or left arrow key to review available selections (detailed below). If Day Time or Date Time is selected, those items will also need to be programmed. After making all load selections, the ACTION (fourth line) flashes.

3. Turn the Load Module ON or OFF

When the fourth line flashes, press the right or left arrow key to review available selections (Turn OFF load, Turn ON load, or Warning). After selecting the action, the DELAY (S) flashes.

4. Select a Time Delay

Select delay of S for seconds or M for minutes. If no delay is required, leave this selection as "S". When the two delay digits are flashing, use the right or left arrow to select 00 to 99.

Press Enter after this final selection to flash the entire program step block. Review all selections of this step with your chart. Press Enter to confirm step or escape to make a change. Make a change the same way as described above. The selections are available in the same sequence.

Press the right arrow to display the next program step. The step number (1, 2, 3, etc.) is automatically assigned. The last step always says Nothing Selected in the second line. This is the initial screen for programming the next step.

Power Management Programming Elements

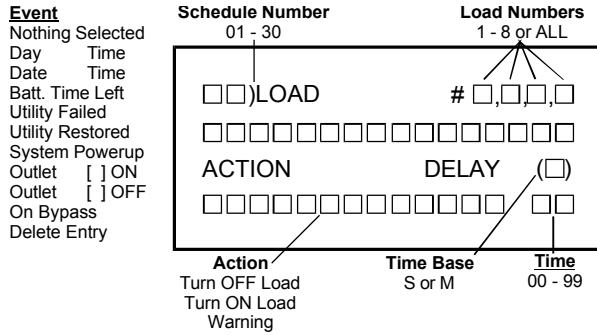

Loads

These Load selections are available: 1, 2, 3, 4, 5, 6, 7, 8, All. A "load" as referenced in this section is the Load Module. Since some load modules contain two receptacles, both receptacles are considered one "load". Load Modules are numbered from top to bottom in the Configurable Distribution unit.

Events

The following Event selections (schedule or conditions) are available:

- **Day Time:** Individual days, All, M-F, and S-S. Time is based on 24 hour clock, and then to the minute.
- **Date Time:** Month and Day (avoid invalid dates such as FEB 30). Time is based on 24 hour clock, and then to the minute.
- **Batt Time Left:** Based on UPS internal calculation. Note that this is not battery time elapsed.
- **Utility Failed**
- **Utility Restored**
- **Outlet [X] ON:** X can be 1 to 8. This event links selected loads in the first line to the load selected here. This link is ignored when in override mode.
- **Outlet [X] OFF:** X can be 1 to 8. This event links the selected loads in the first line to the load selected here. This link is ignored when in override mode.
- **On Bypass**
- **Delete Entry:** Deletes an entire program step (ignore all other flashing selections for this process).

Actions

The following Action selections are available:

- **Turn OFF load**
- **Turn ON load**
- **Warning**

Delays

The following Delay selections are available:

S	Seconds	00 to 99
M	Minutes	00 to 99

If no delay is required, leave this selection as S with a value of 00. The right arrow increases from 01 in increments of 1. The left arrow decreases from 99 in increments of 1.

Override

The Override selection causes immediate action to a load module regardless of what was programmed. Linked outputs are ignored during an override command. These Override selections are available:

- **As Scheduled**
- **Force Power OFF**
- **Force Power ON**
- **Reboot (OFF-ON) OFF for 30 seconds**

The screen displays:

- **Load #X:** Use right or left arrow to display 1 to 8
- **Load Label:** See Load Labels section
- **As Scheduled:** Use right or left arrow to select option

NOTE: After an override, it is important to return the load module to its current state (ON or OFF) via **Force Power ON/OFF**, and then return it to **As Scheduled**.

Load Labels

Assign Load Labels of up to 16 characters. Some labels are factory preprogrammed. Since UPS controls do not provide an alphanumeric keyboard, use right or left arrow to display a selection, then press enter to select. The following selections are available:

- | | |
|-----------------|------------------------------------|
| Bridge | Terminal |
| Computer | No Label |
| Display | Individual letters (A to Z) |
| Hub | Individual numbers (0 to 9) |
| Modem | Selected symbols |
| Router | Blank space |
| Server | |

In applying labels, remember that some Load Modules supply power to more than one device.

Operation

Selected program steps become active as soon as they are entered. Maintain a chart of selections. Change the chart when you change the program.

For assistance call Liebert at 1-800-222-5877.

Sample Programs

Refer to Sample Programs #1 and #2 on the following pages.

POWER MANAGEMENT SAMPLE #1

Objective: Save energy by turning OFF computers after hours. Specifically, turn ON all loads except load 03 at 7:00 a.m. and then turn them OFF at 6:00 p.m. every workday (M-F). Remain off during the weekend.

Define Parameters

Start	Closure
Loads: #1,2,4	Loads: #1,2,4
Action: Turn ON loads	Action: Turn OFF loads
Event: Time of Day	Event: Utility Restored
Delay: None	Delay: None

Step #1A:

01)LOAD	#1,2,4,0
Nothing Selected	
ACTION	DELAY (S)
Turn OFF load	00

Step #1A indicates selection of load modules 1,2, and 4.

Step #1B:

01)LOAD	#1,2,4,0
Day	Time
ACTION	DELAY (S)
Turn OFF load	00

Step #1B indicates selection of the Day/Time feature.

Step #1C:

01)LOAD	#1,2,4,0
M-F	7:00
ACTION	DELAY (S)
Turn ON load	00

Step #1C indicates loads 1,2, and 4 turn On at 7:00 a.m. Monday through Friday with no time delay.

Step #2:

02)LOAD	#1,2,4,0
M-F	18:00
ACTION	DELAY (S)
Turn OFF load	00

Step #2 indicates loads 1,2 and 4 turns OFF at 6:00 p.m. (18:00) Monday through Friday with no time delay.

POWER MANAGEMENT SAMPLE #2

Objective: Extend battery time by shutting down less critical loads. Specifically, remove load #1 one minute after going on battery, and load #2 two minutes after going on battery. When utility power returns, put loads #1 and #2 back on line.

Define Parameters

Start	Closure
Loads: #1,2	Loads: #1,2
Action: Turn OFF loads	Action: Turn ON loads
Event: Utility Failed	Event: Utility Restored
Delay: 1&2 minutes	Delay: None

Step #1A:

01)LOAD	#1,0,0,0
Nothing Selected	
ACTION	DELAY (S)
Turn OFF load	00

Step #1A indicates selection of load module #1.

Step#1B:

01)LOAD	#1,0,0,0
Utility Failed	
ACTION	DELAY (M)
Turn OFF load	00

Step #1B shed load #1 one minute after utility fails.

Step#2:

01)LOAD	#2,0,0,0
Utility Failed	
ACTION	DELAY (S)
Turn OFF load	00

Step #2 sheds load #2 two minutes after utility fails

Step#3:

01)LOAD	#1,2,0,0
Utility Restored	
ACTION	DELAY (S)
Turn ON load	00

Step #3 turns on #1 and #2 with no time delay when utility power returns.

Remote Emergency Power Off (REPO) Cable

This optional 50-foot cable includes the attached matting connector for connection to the UPS. The REPO connector is at the rear of the unit. The factory supplied switch provides a normally open (N.O.) contact rated for 1 Amp at 24 Volts. Pressing the REPO button opens the UPS Output Circuit Breaker and disables battery charging. See the figure below.

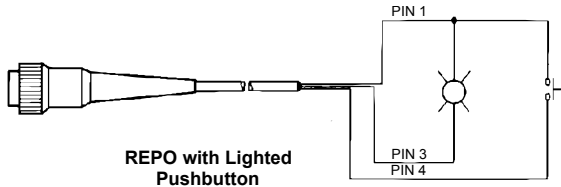

NOTES:

- Run all customer-supplied control wiring in separate rigid steel conduit from power wiring.
- Wire in accordance with national and local electrical codes.
- See drawings in Connections for UPS REPO connector location.
-

Communications Options

The UPS supports the following methods of communication:

- SiteNet 1 (automatic, unattended shutdown)
- SiteNet 2 (Power Surveillance software)
- SiteNet SNMP (Simple Network Management Protocol)
- Terminal / Modem Connection

SiteNet 1, SiteNet 2, terminal mode and modem operation require the RS-232 Kit. This kit provides a plug-in communications board that includes relays, serial communications and a DB25 connector for interfacing to the SiteNet software kits.

SiteNet 1 Shutdown Interface Kits

Each option kit includes a 10-foot communication cable with connectors, necessary software for computer interface to the UPS, and separate instructions for installation and operation. A power failure will initiate a pre-programmed timer. Then the software performs an automatic, unattended, orderly shutdown. If the UPS reaches a low battery condition, the software overrides the timer and performs an orderly shut-down. The software runs as a background task on the computer while monitoring the UPS.

SiteNet 2 Power Surveillance

This option includes software to enable UPS monitoring and control from a remote computer or workstation. Contact a Liebert UPS supplier for more details including availability for your computer or workstation

SiteNet SNMP (Simple Network Management Protocol)

The SiteNet SNMP internal agent allows for direct network UPS management in an Ethernet environment. The internally mounted SNMP agent provides true product integration. It draws uninterruptible power from the UPS and eliminates the need for a second UPS for the agent. Remotely configure the agent via BOOTP and TFTP. Configuration and bootstrap are stored in non-volatile memory. The MIB is MIB II compliant. The SNMP option ships with the MIB in DOS and TAR formats complete with a configuration cable.

Terminal/Modem Connection

All information and functions accessed through the control panel are also accessible by a terminal, host computer, or modem through the RS-232 port. You may connect a terminal or computer to the RS-232 port directly or through a modem. The UPS dials out to a selected phone number to report alarm conditions and connects when called from a terminal.

The terminal shows a picture of the LCD display screen. The UPS responds to the left arrow, right arrow, enter, and escape keys on the keyboard just as it would from the UPS control panel. View UPS meters and alarm history, change configuration settings, and activate remote start, stop, and transfer (if bypass is available) all from a remote terminal.

Terminal Operation: Connect an ANSI terminal (or a computer with an appropriate terminal emulator program, e.g. ProComm) to the UPS directly or through a modem connection. See **Cables** for connection details.

Set up the computer terminal as follows:

Baud rate: 2400	Data bits: 8
Stop bits: 1	Parity: none
Full duplex	

The RS-232 interface can operate in terminal mode which shows the LCD display on the screen, or ESP mode which only qualified service personnel use. To use terminal mode, press the space bar. The LCD display appears on the screen and the left arrow, right arrow, enter, and escape keys become operable. If the LCD display does not appear, the RS-232 may be in ESP mode. Type EXIT to return the RS-232 to terminal mode.

The UPS responds to requests such as viewing UPS meters or alarm history. Some configuration selections (other than voltage or frequency) can be changed during UPS operation. Use the configuration screens UPS ON(1)/OFF(0) and Transfer UPS to remotely turn the UPS ON or OFF, or make transfers (if bypass is available).

Modem Operation: Connect the UPS to a remote computer terminal through a modem link (one modem at each end). See **Cables** for connection details. The UPS automatically tests for a modem every three minutes, when the communication channel is idle.

Use the following Modem Mode configuration screen to control modem operations:

```

Modem Mode: IN
1-(000) 000-0000
Site ID:
Your Location
  
```

The options of the first line of this screen are **IN**, **OUT**, **BOTH**, or **OFF**. **IN** calls are from a remote terminal operator to the UPS. **OUT** calls are alarms reported from the UPS to a selected phone number with a modem attached. **BOTH** enables both **IN** and **OUT** calls. **OFF** disables modem connections, but a directly connected computer terminal may still be used.

The second line allows entry of the phone number the UPS calls when alarms occur. Remember to include a 9 or other characters if required. When initiating a call, the UPS makes up to 3 attempts to connect, spaced 45 to 90 seconds apart, before giving up.

Enter the **Site ID** on the fourth line. The UPS includes **Site ID** in **OUT** messages to distinguish multiple UPS's programmed to call the same phone number. Use up to 16 characters (letters, numbers, and spaces) for the **Site ID**.

For terminal IN calls, the screen displays "Press <SPACE BAR> to enter terminal mode...". Use the keyboard to get information from the UPS or to perform remote ON, OFF, or Transfer as described above. If no keys are pressed for 6 minutes, the UPS hangs up.

For UPS OUT calls, the receiving terminal beeps and displays the message "Press any key to enter terminal mode...". If no key is pressed within 10 seconds, the terminal displays present alarm condition(s) information along with the Site ID. The time of each alarm displays to the nearest tenth of a second.

The event code(s) alarm description also display. Then the message "Press any key to enter terminal mode..." displays again. Press a key to enter terminal mode, and show the LCD display as described earlier in Terminal Operation. If no keys are pressed for 45 seconds, the UPS hangs up.

RS-232 with User-Configurable Relays - VCR232C

This provides user-selected contact closure output on the RS-232 board, for use with remote monitoring devices. The board also includes two relays. Program these relays as NO or NC to activate upon any combination of these alarms:

- UPS on Battery**
- Low Battery**
- UPS on Bypass**
- Battery Test Fail**
- UPS Fail Overload**

These relay outputs use an RJ45 connector. Connector and 25' pigtail supplied. Program the relays via the UPS LCD display on the front panel.

Cables

- An optional factory-assembled 6-foot cable enables connection to a modem.
- A factory-assembled splitter cable enables connection to a modem (or terminal) and a Computer/LAN interface.
- To assemble a customer supplied cable, refer to the following instructions and Figure #5:
- For a modem cable, connect to pins 2, 3, 7, 8, 20, and 22. Connect Pin 2 on one end to pin 3 on the other end (this applies to two wires). All other connections are straight through.

For a terminal cable (direct connection, no modem) connect to pins 2, 3, and 7. All connections are straight through.

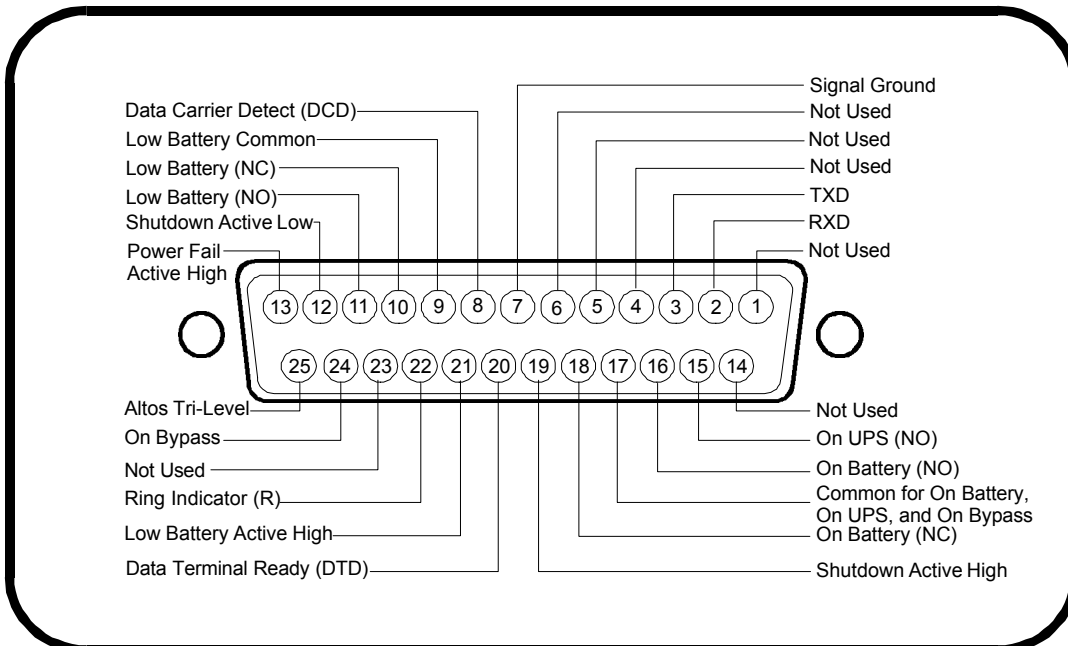

External Battery Cabinets

WARNING: Remove UPS battery fuses and open the Battery Cabinet circuit breaker before removing the battery cable connectors cover plate. These connectors contain lethal voltages when the circuit to the battery is complete.

Standard External Battery Cabinets

Matching stand-alone cabinet(s) can be provided with additional string(s) of low-maintenance batteries for additional back-up time in conjunction with the UPS internal battery. Each cabinet includes a fuse and a circuit breaker disconnect. The UPS-to-battery cabinet wiring allows for cabinet location directly adjacent to the UPS module. See Figures below and on the following page. See Battery Time Curves in Appendix.

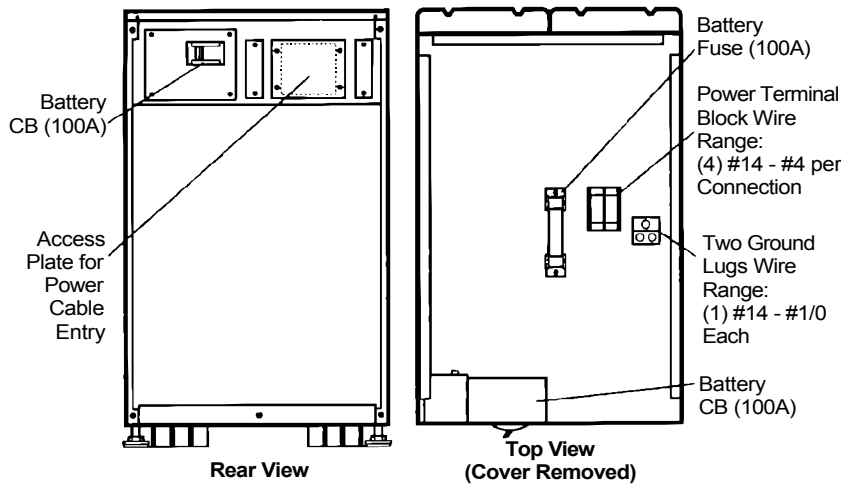
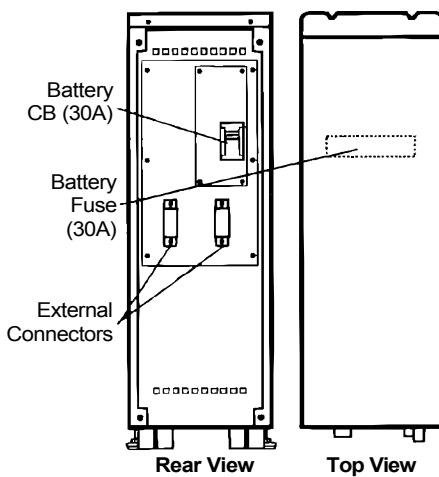
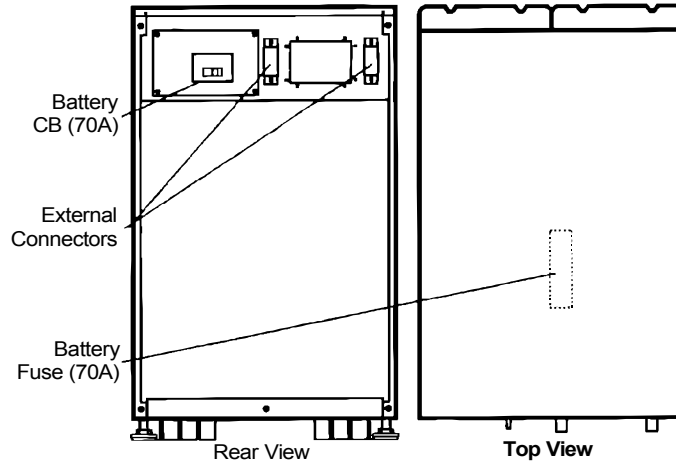
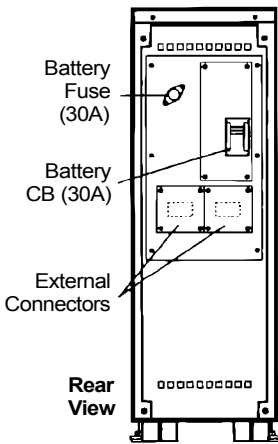
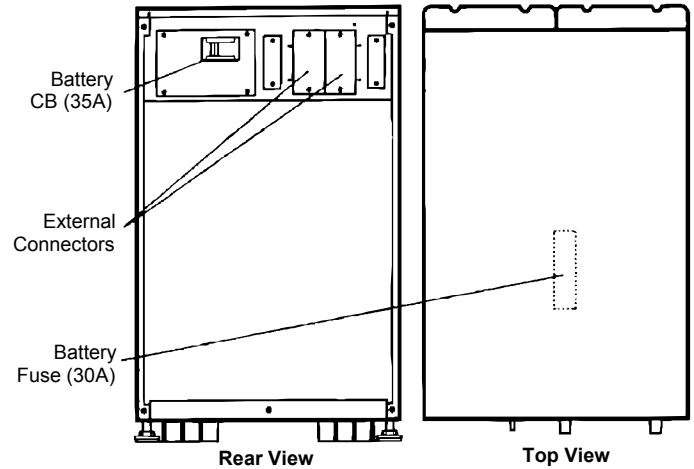

Routine Maintenance

The Liebert UPStation S™ UPS should operate for years with minimum maintenance. Keep UPS clean and cool to enhance system reliability. Occasionally vacuum dust from around ventilation grilles and wipe UPS with a dry cloth. Do not use liquid or aerosol cleaning fluids. Periodically check UPS operation by switching off utility power and observing the On Battery message. Do this with only non-critical loads connected to the unit.

Liebert UPStation S™ Specifications	
SYSTEM	
Safety Agencies	CSA 22.2, UL 1778 listed
Audible Noise	55 dBA at one meter
Transient/ Surge Protection	Per IEEE 587/ANSI C62.41 Class A&B
Efficiency	Minimum 87% at full load
PHYSICAL CHARACTERISTICS (See Site Planing Data for dimensions and weight)	
Operating Environment	0 degrees C to 40 degrees C
Relative Humidity	0 to 95% relative humidity (non-condensing)
Altitude	5000 feet without derating
AC INPUT	
Voltage Range	176 to 264 VAC
Voltage Configuration and Connection	Single phase, 3-wire plus ground (L1-L2-N-G) Single phase, 2-wire plus ground (L1-N-G) Three phase, 4-wire plus ground (L1-L2-L3-N-G) (8-18 kVA only) Three phase, 3-wire plus ground (L1-L2-L3-G) (8-18 kVA only)
Frequency Range	45 Hz to 65 Hz
Current THD	5% THD maximum at full load
Power Factor	.98 typical
AC OUTPUT	
Voltage Regulation	Typically less than +/- 2%
Voltage Distortion	Max. 3% THD for linear loads, max. 5% THD for full non-linear loads
Transient Response	Less than +/- 5% for 100% step load; recovery to within 1% in 50 ms.
Frequency	50 Hz or 60 Hz
Frequency Slew Rate	1 Hz/sec (user-selectable 0.3 to 3 Hz/sec)
Frequency Sync Rate	+/- 1 Hz (user selectable +/- 0.1 Hz to 5 Hz)
Load Crest Factor	3:1
Overload	125% for 10 minutes, 150% 10 seconds
BATTERY	
Type	Sealed, low maintenance, lead acid
Recharge Rate	10 times discharge duration to 95%
Battery Runtime	Minimum 10 minutes at full load
Battery Voltage	Nominal: 192 VDC Float: 220 to 230 VDC

APPENDIX

NEC Wire Gauge Chart

Allowable Ampacities of Insulated Conductors Rated 0 – 2000 Volts, 60° to 90°C (140° to 194°F), not more than three conductors in Raceway or Cable or Earth (Directly Buried), Based on Ambient Temperature of 30°C (86°F)

Size AWG kcmil	Temperature Rating of Conductor						Size AWG kcmil
	60°C (140°F) Types: TW*, UF*	75°C (167°F) Types: FEPW*, RH*, RHW*, THHW*, THW*, THWN*, XHHW*, USE*, ZW*	90°C (194°F) Types: TA, TBS, SA, SIS, FEP*, FEPB*, MI, RHH*, RHW-2, THHN*, THHW*, THW-2, THWN-2, USE-2, XHH, XHHW*, XHHW-2, ZW-2	60°C (140°F) Types: TW*, UF*	75°C (167°F) Types: RH*, RHW*, THHW*, THW*, THWN*, XHHW*, USE*	90°C (194°F) Types: TA, TBS, SA, SIS, THHN*, THHW*, THW-2, THWN-2, RHH*, RHW-2, USE-2, XHH, XHHW*, XHHW-2, ZW-2	
Copper			Aluminum or Copper-Clad Aluminum				
18	-	-	14	-	-	-	-
16	-	-	18	-	-	-	-
14	20*	20*	25*	-	-	-	-
12	25*	25*	30*	20*	20*	25*	12
10	30	35*	40*	25	30*	35*	10
8	40	50	55	30	40	45	8
6	55	65	75	40	50	60	6
4	70	85	95	55	65	75	4
3	85	100	110	65	75	85	3
2	95	115	130	75	90	100	2
1	110	130	150	85	100	115	1
1/0	125	150	170	100	120	135	1/0
2/0	145	175	195	115	135	150	2/0
3/0	165	200	225	130	155	175	3/0
4/0	195	230	260	150	180	205	4/0
250	215	255	290	170	205	230	250
300	240	285	320	190	230	255	300
350	260	310	350	210	250	280	350
400	280	335	280	225	270	305	400
500	320	380	430	260	310	350	500
600	355	420	475	285	340	385	600
700	385	460	520	310	275	420	700
750	400	475	535	320	385	435	750
800	410	490	555	330	395	450	800
900	435	520	585	355	425	480	900
1000	455	545	615	375	445	500	1000
1250	495	590	665	405	485	545	1250
1500	520	625	705	435	520	585	1500
1750	545	650	735	455	545	615	1750
2000	560	665	750	470	560	630	2000
CORRECTION FACTORS							
Ambient Temp. °C	For ambient temperatures other than 30° (86° F), multiply the allowable ampacities shown above by the appropriate factor shown below.						Ambient Temp. °C
21-25	1.08	1.05	1.04	1.08	1.05	1.04	70-77
26-30	1.00	1.00	1.00	1.00	1.00	1.00	78-86
31-35	.91	.94	.96	.91	.94	.96	87-95
36-40	.82	.88	.91	.82	.88	.91	96-104
41-45	.71	.82	.87	.71	.82	.87	105-113
46-50	.58	.75	.82	.58	.75	.82	114-122
51-55	.41	.67	.76	.41	.67	.76	123-131
56-60	-	.58	.71	-	.58	.71	132-140
61-70	-	.33	.58	-	.33	.58	141-158
71-80	-	-	.41	-	-	.41	159-176

*Unless otherwise specifically permitted elsewhere in this Code the overcurrent protection for conductor types marked with an asterisk shall not exceed 15 amperes for No.14, 20 amperes for No.12, and 30 amperes for No.10 copper; or 15 amperes for No.12 and 25 amperes No. 10 aluminum and copper-clad aluminum after any correction factors for ambient temperature and number of conductors have been applied.

Reprinted with permission from NFPA 70-1996, the National Electrical Code®, Copyright 1995, National Fire Protection Association, Quincy, MA 02269. This reprinted material is not the complete and official position of the National Fire Protection Association on the referenced subject which is represented only by the standard in its entirety.



3.5 - 4.5 kVA Battery Run Times

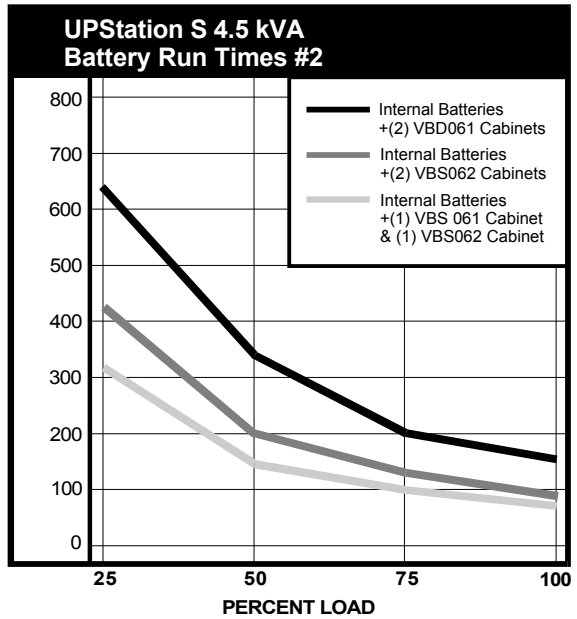
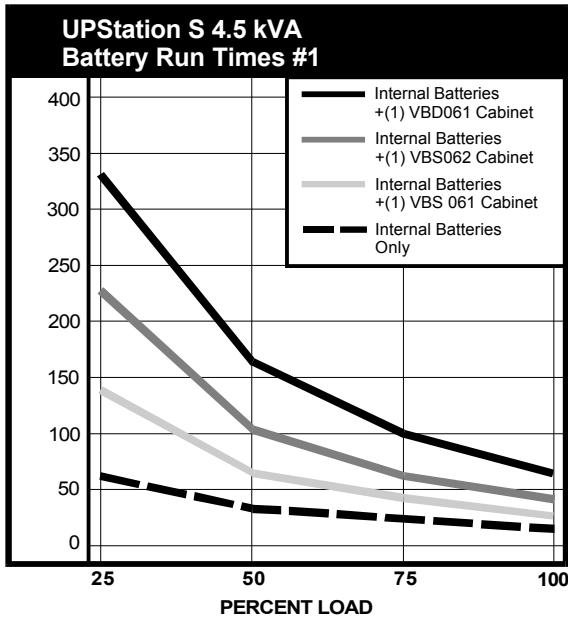
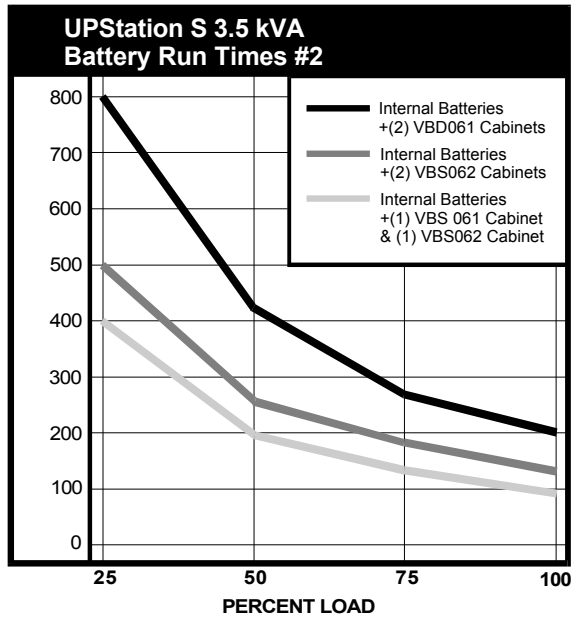
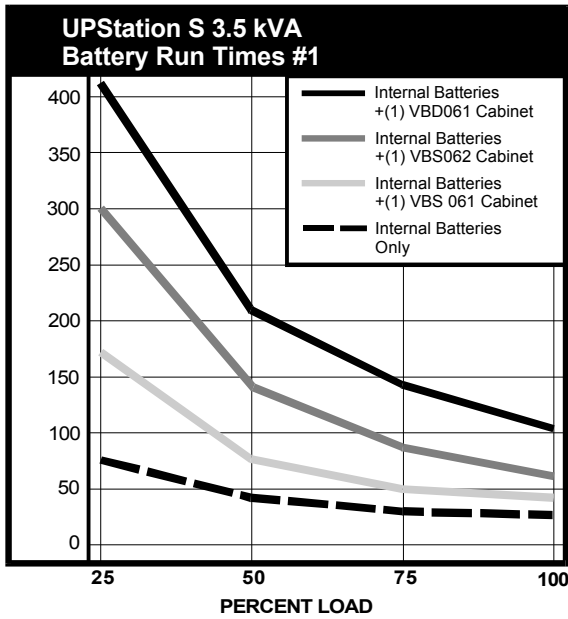

6 – 8 kVA Battery Run Times

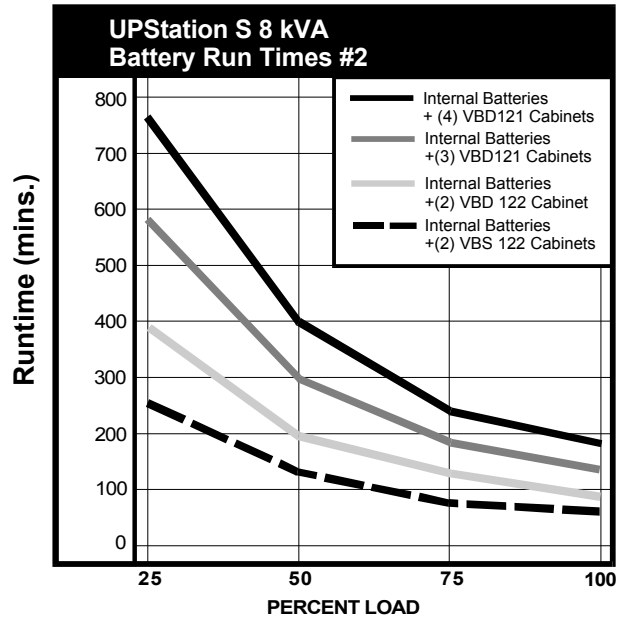
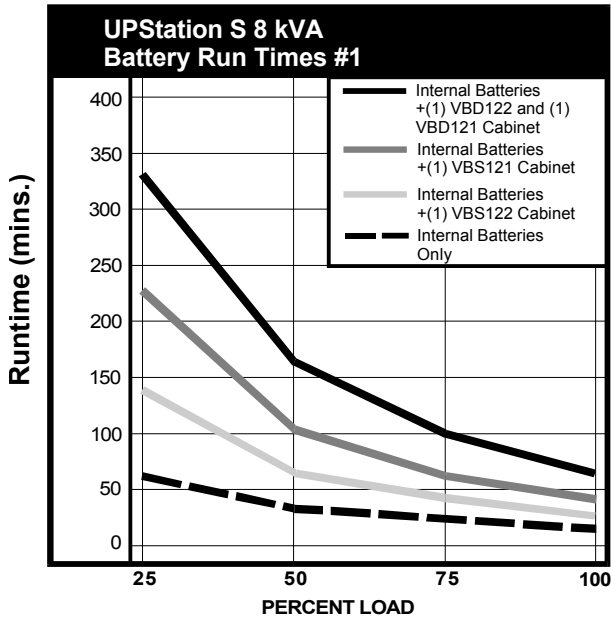
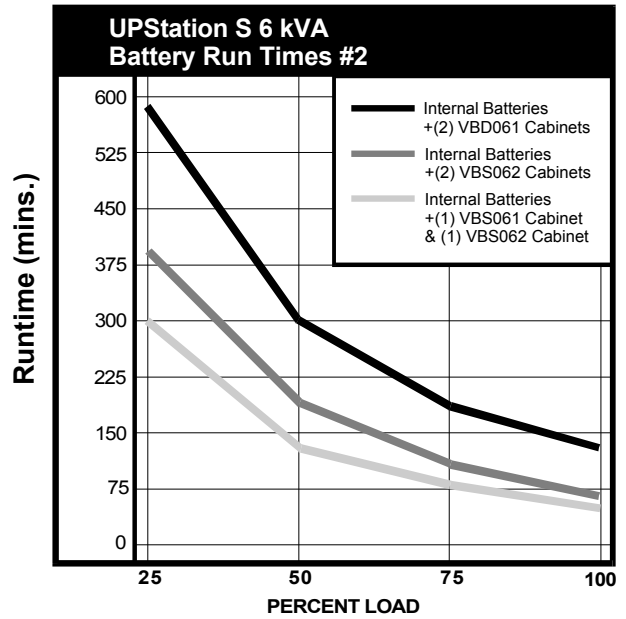
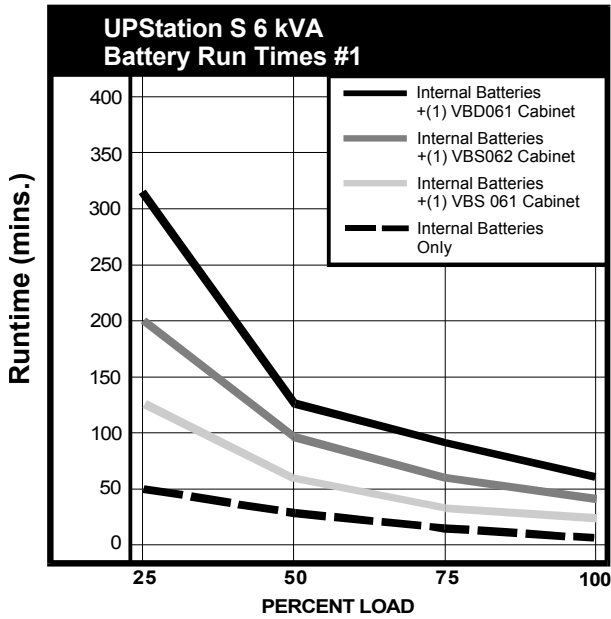

10 – 12 kVA Battery Run Times

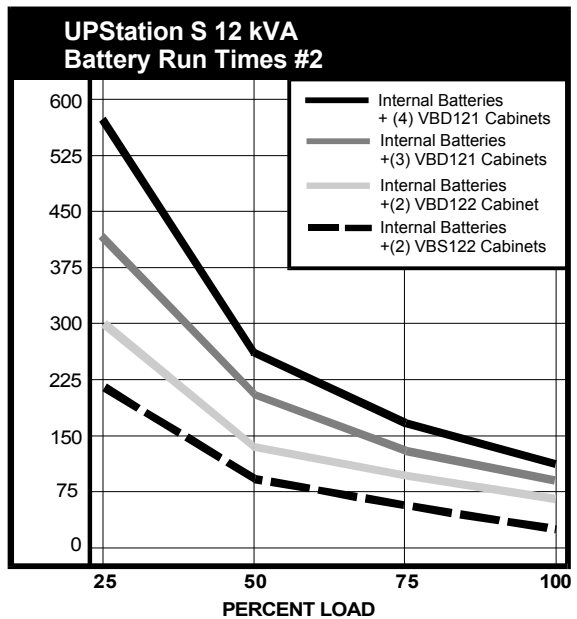
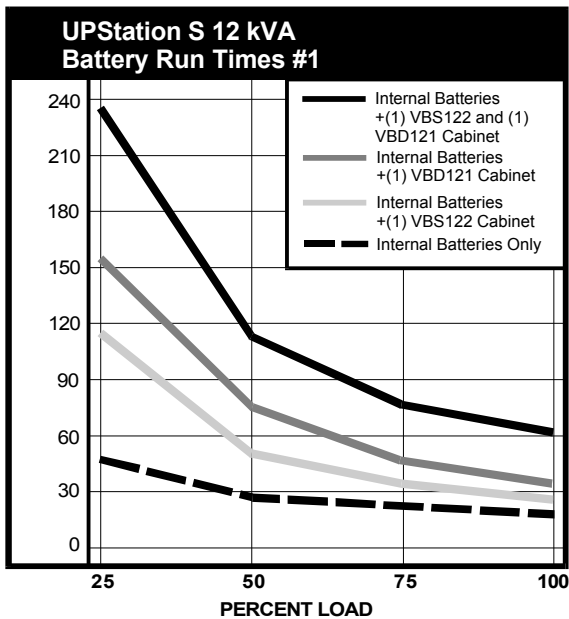
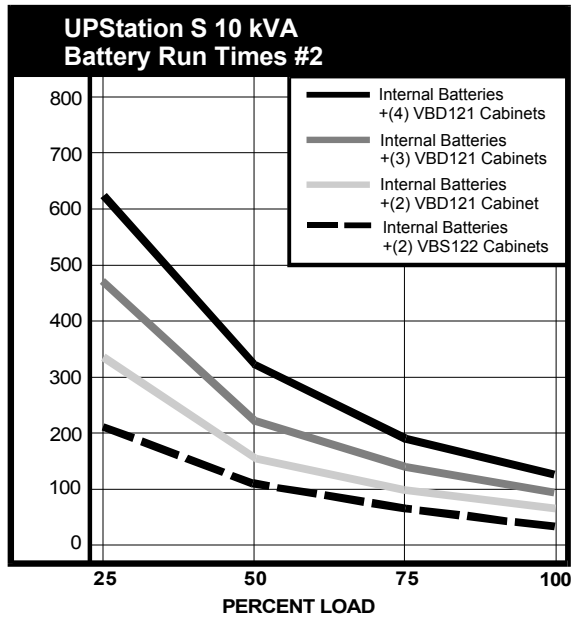
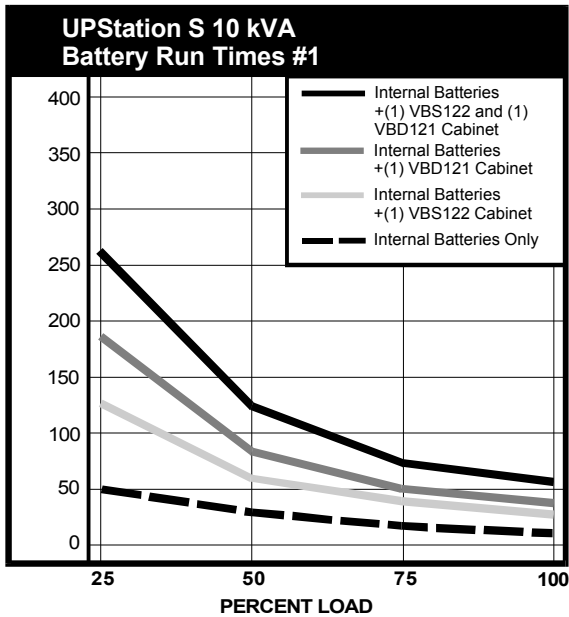

18 kVA Battery Run Times

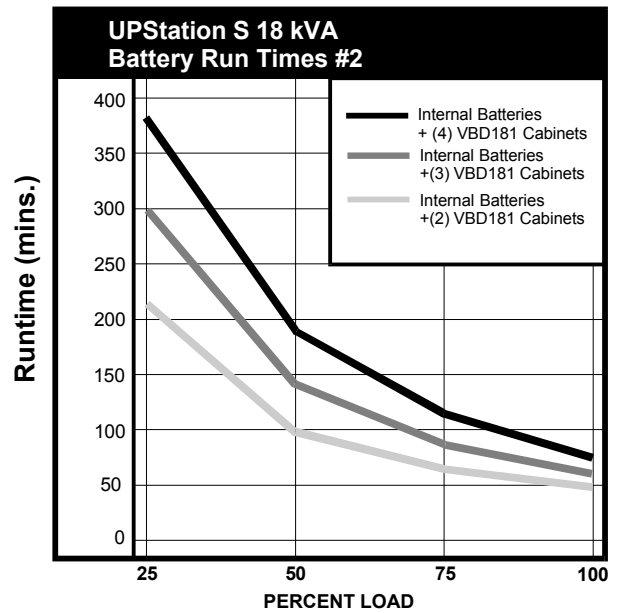
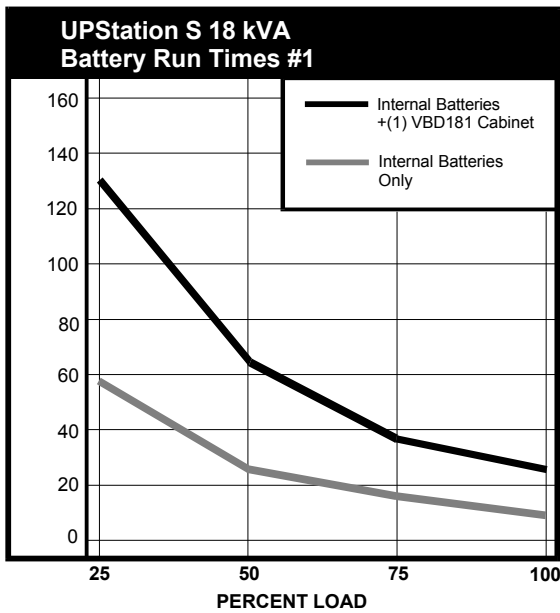
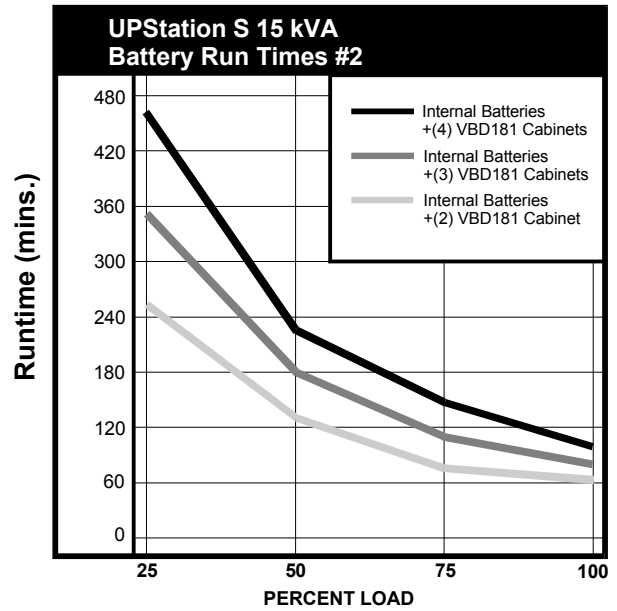
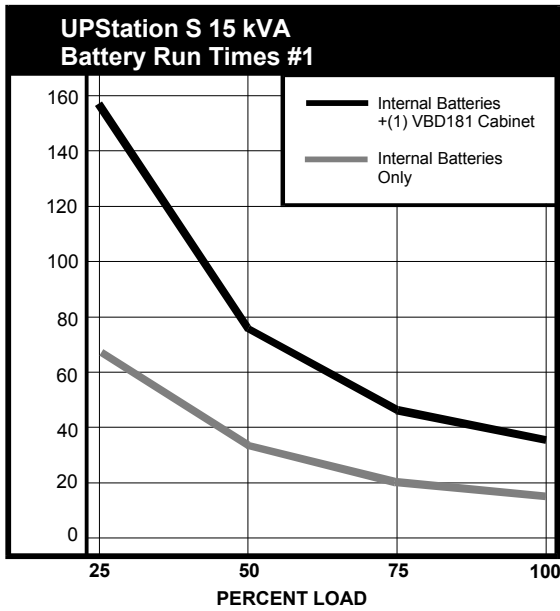

Alarm Messages, Meanings, and Corrective Actions

	MESSAGE	MEANING	CORRECTIVE ACTION
Start-Up	Start-Up Sequence Aborted	The UPS detects a condition that prevents a complete start-up.	Review and record all alarm messages. Perform prescribed action for specified alarm. If Start up still aborts, contact Liebert at 1-800-222-5877.
	Site Wiring Error	Incorrect phasing sequence of power conductors wired to UPS.	Disconnect power from the UPS and call a qualified electrician to correct and verify the wiring.
	Incorrect Input Frequency	Input power frequency outside acceptable range.	Select the correct frequency in the configuration screen. Verify the utility frequency.
AC	Input Power Out of Tolerance	Input power frequency outside acceptable range. UPS battery supplying power to load equipment.	No corrective action required.
Battery	Battery Failed Test	Automatic Battery Test detects a weak battery.	Repeat the battery test via the LCD "Test Options" menu selection. If battery fails again, contact Liebert at 1-800-222-5877.
	Can't execute battery test: not recharged	Battery discharged too recently to perform test.	No corrective action required. UPS will perform next scheduled battery test.
	Battery Date Expired	Batteries are over 5 years old.	Contact Liebert at 1-800-222-5877 to replace batteries.
	UPS On Battery Time Remaining: XX Minutes	Battery discharging. UPS calculates and displays remaining battery time.	Perform an orderly shutdown of load equipment before time expires or shut off unnecessary load equipment to extend battery time.
	Low Battery Shutdown	UPS discharged battery to minimum allowable voltage and automatically shut down. No power supplied to load.	Upon return of power, start up UPS. The UPS starts up by itself if Auto-Restart is enabled.
	Charger Battery Voltage High	Battery voltage exceeds acceptable limits causing automatic charger shutdown. Charger automatically restarts when battery voltage return to acceptable levels.	Contact Liebert at 1-800-222-5877 if this condition persists for more than 2 minutes.
Bypass	WARNING: Load On Bypass	Load currently powered through bypass line due to automatic or manual transfer to bypass. Load unprotected from power disturbances or outages.	If automatic transfer to bypass, load returns to UPS power control for most temporary conditions. Review and record any other alarm messages. If manual transfer to bypass, return to UPS power control when possible.
	Bypass power out of tolerance Bypass out of Sync	Bypass power voltage or frequency outside acceptable limits. Automatic bypass transfer prohibited.	Manual transfer to bypass not recommended. Wait for bypass power to return.
	Bypass Overload	At least one phase of bypass current overloaded.	Reduce the load.
	Excessive Retransfer Attempted	UPS completed at least 15 attempts to retransfer load from utility back to UPS in 20 minutes or less. UPS unable to sustain load due to overload or inverter failure. Load remains on bypass.	Check other messages for inverter failure. Determine cause of overload and reduce load.
UPS System	System Shutdown Press ON to Restart System	Power Factor Corrector detects temporary condition at input of UPS.	Press ON button to restart system. If start-up aborts, review and record alarm messages and contact Liebert at 1-800-222-5877.
	Output Undervoltage Output Overvoltage	UPS output voltage or current outside acceptable limits. Load automatically transferred to bypass. UPS attempts automatic retransfer when voltage or current is within acceptable limits.	If UPS is unable to correct either one of these conditions, contact Liebert at 1-800-222-5877.
	Overload Phase A Overload Phase B Output Overload	Overload. UPS automatically transfers load to bypass if overload exceeds UPS capacity.	Determine cause of overload and reduce load.
	Fault: SYSTEM SHUTDOWN	UPS detects a fault and shuts down resulting in loss of power to load.	Review and record alarm messages and contact Liebert at 1-800-327-4384
	Logic Error	Automatic diagnostic testing detects a hardware or software failure in UPS internal control system	Contact Liebert at 1-800-222-5877
	External Shutdown	External contact shuts down UPS through REPO.	Start-up UPS after correcting cause of external shut-down.
**	System Shutdown Impending Due to Overtemp	UPS cabinet temperature above acceptable limits. UPS automatically shuts down in 2 minutes if over-temperature continues.	Check for restricted air flow or fan failure. If none, contact Liebert at 1-800-222-5877
*	Dial-Out Attempt Failed	UPS unsuccessfully attempted to dial out due to an event.	Usually, the dial-out phone line is simply busy. Check for secure and correct modem connection.



UPStation® S

Power Protection

U.S.A.
Worldwide Support
U.K.
France
Germany
Italy
Netherlands
E-mail
Web site
Worldwide FAX tech support

1-800-222-5877
614-841-6755
+44 (0) 1793 553355
+33 (0) 1 43 60 01 77
+49 89 99 19 220
+39 2 98250 1
+31 (0) 475 503333
upstech@liebert.com
<http://www.liebert.com>
+614-841-5471

The Company Behind The Products

With more than 500,000 installations around the globe, Liebert is the world leader in computer protection systems. Since its founding in 1965, Liebert has developed a complete range of support and protection systems for sensitive electronics:

- Environmental systems: close-control air conditioning from 1.5 to 60 tons.
- Power conditioning and UPS with power ranges from 250 VA to more than 1000 kVA.
- Integrated systems that provide both environmental and power protection in a single, flexible package.
- Monitoring and control — on-site or remote — from systems of any size or location
- Service and support, through more than 100 service centers around the world, and a 24-hour Customer Response Center.

While every precaution has been taken to ensure accuracy and completeness of this literature, Liebert Corporation assumes no responsibility, and disclaims all liability for damages resulting from use of this information or for any errors or omissions.

© 1997 Liebert Corporation. All rights reserved throughout the world. Specifications subject to change without notice.

® Liebert and the Liebert logo are registered trademarks of Liebert Corporation. All names referred to are trademarks or registered trademarks of their respective owners.

SL-24870 (2/98) Rev. 2

DISCONTINUED
PRODUCT