



eSure™

Rectifier Module

User Manual (UM1R483500e), Revision T

Specification Number: 1R484000e, 1R483500e, 1R483200e, 1R483200

Model Number: R48-4000e, R48-3500e, R48-3200e, R48-3200

The information contained in this document is subject to change without notice and may not be suitable for all applications. While every precaution has been taken to ensure accuracy and completeness herein, Vertiv Group Corp. assumes no responsibility, and disclaims all liability, for damages resulting from use of this information or for any errors or omissions. Refer to other local practices or building codes as applicable for the correct methods, tools, and materials to be used in performing procedures not specifically described in this document.

This document may contain confidential and/or proprietary information of Vertiv Group Corp., and its receipt or possession does not convey any right to reproduce, disclose its contents, or to manufacture or sell anything that it may describe. Reproduction, disclosure, or use without specific authorization from Vertiv Group Corp. is strictly prohibited.

Vertiv and the Vertiv logo are trademarks or registered trademarks of Vertiv Group Corp. All other names and logos referred to are trade names, trademarks or registered trademarks of their respective owners.

© 2019 Vertiv Group Corp. All rights reserved.

TABLE OF CONTENTS

Admonishments Used in this Document.....	4
Important Safety Instructions	5
General Safety	5
Voltages	5
AC Input Voltages.....	5
DC Output and Battery Voltages	5
Hazardous Voltage.....	5
Handling Equipment Containing Static Sensitive Components.....	5
Static Warning.....	6
Introduction	7
Overview.....	7
Specifications	7
DC Output Ratings.....	7
AC Input Ratings.....	13
Environmental Ratings.....	18
Compliance Information:.....	19
Standard Features.....	19
Mechanical Specifications.....	22
Operation.....	23
AC Input Protection Device Requirements/Recommendations.....	23
Local Indicators.....	23
Rectifier High Voltage Shutdown and Lockout Restart.....	24
Installing Rectifiers.....	25
Troubleshooting and Repair	26
Troubleshooting.....	26
Rectifier Current Sharing Imbalance.....	26
Rectifier Fault Symptoms and Troubleshooting.....	26
Replacement Procedures.....	28
Rectifier Replacement.....	28
Rectifier Fan Replacement	29

ADMONISHMENTS USED IN THIS DOCUMENT



DANGER! Warns of a hazard the reader *will* be exposed to that will *likely* result in death or serious injury if not avoided. (ANSI, OSHA)



WARNING! Warns of a potential hazard the reader *may* be exposed to that *could* result in death or serious injury if not avoided. This admonition is not used for situations that pose a risk only to equipment, software, data, or service. (ANSI)



CAUTION! Warns of a potential hazard the reader *may* be exposed to that *could* result in minor or moderate injury if not avoided. (ANSI, OSHA) This admonition is not used for situations that pose a risk only to equipment, data, or service, even if such use appears to be permitted in some of the applicable standards. (OSHA)



ALERT! Alerts the reader to an action that *must be avoided* in order to protect equipment, software, data, or service. (ISO)



ALERT! Alerts the reader to an action that *must be performed* in order to prevent equipment damage, software corruption, data loss, or service interruption. (ISO)



FIRE SAFETY! Informs the reader of fire safety information, reminders, precautions, or policies, or of the locations of fire-fighting and fire-safety equipment. (ISO)



SAFETY! Informs the reader of general safety information, reminders, precautions, or policies not related to a particular source of hazard or to fire safety. (ISO, ANSI, OSHA)

IMPORTANT SAFETY INSTRUCTIONS

General Safety



DANGER! YOU MUST FOLLOW APPROVED SAFETY PROCEDURES.

Performing the following procedures may expose you to hazards. These procedures should be performed by qualified technicians familiar with the hazards associated with this type of equipment. These hazards may include shock, energy, and/or burns. To avoid these hazards:

- a) The tasks should be performed in the order indicated.
- b) Remove watches, rings, and other metal objects.
- c) Prior to contacting any uninsulated surface or termination, use a voltmeter to verify that no voltage or the expected voltage is present. Check for voltage with both AC and DC voltmeters prior to making contact.
- d) Wear eye protection.
- e) Use certified and well maintained insulated tools. Use double insulated tools appropriately rated for the work to be performed.

Voltages

AC Input Voltages



DANGER! This system operates from AC input voltage capable of producing fatal electrical shock.

DC Output and Battery Voltages



DANGER! This system produces DC power and may have a battery source connected to it. Although the DC voltage is not hazardously high, the rectifiers and/or battery can deliver large amounts of current. Exercise extreme caution not to inadvertently contact or have any tool inadvertently contact an output terminal or battery terminal or exposed wire connected to an output terminal or battery terminal. NEVER allow a metal object, such as a tool, to contact more than one termination or battery terminal at a time, or to simultaneously contact a termination or battery terminal and a grounded object. Even a momentary short circuit can cause sparking, explosion, and injury.

Hazardous Voltage



DANGER! HAZARD OF ELECTRICAL SHOCK.

More than one disconnect may be required to de-energize the system before servicing.

Handling Equipment Containing Static Sensitive Components



ALERT! Installation or removal of equipment containing static sensitive components requires careful handling. Before handling any equipment containing static sensitive components, read and follow the instructions contained on the Static Warning Page.

STATIC WARNING



This equipment contains static sensitive components. The warnings listed below must be observed to prevent damage to these components. Disregarding any of these warnings may result in personal injury or damage to the equipment.

1. Strictly adhere to the procedures provided in this document.
2. Before touching any equipment containing static sensitive components, discharge all static electricity from yourself by wearing a wrist strap grounded through a one megohm resistor. Some wrist straps have a built-in one megohm resistor; no external resistor is necessary. Read and follow wrist strap manufacturer's instructions outlining use of a specific wrist strap.
3. Do not touch traces or components on equipment containing static sensitive components. Handle equipment containing static sensitive components only by the edges that do not have connector pads.
4. After removing equipment containing static sensitive components, place the equipment only on static dissipative surfaces such as conductive foam or ESD bag. Do not use ordinary Styrofoam™ or ordinary plastic.
5. Store and ship equipment containing static sensitive components only in static shielding containers.
6. If necessary to repair equipment containing static sensitive components, wear an appropriately grounded wrist strap, work on a conductive surface, use a grounded soldering iron, and use grounded test equipment.

INTRODUCTION

Overview

The rectifiers provide load power, battery float current, and battery recharge current during normal operating conditions. The rectifiers are a constant power design. The rectifiers are rated at their maximum output power. This means that, within the normal operating ambient temperature range and input voltage range, the maximum available output power is a constant 4000 W, 3500 W, or 3200 W (depending on rectifier model). Within these ranges, the rectifiers operate in one of three modes, depending upon load demands. Transition between modes is completely automatic. If ambient temperature rises above or input voltage falls below acceptable values, rectifiers continue to operate but at derated output power levels.

- **Constant Voltage Mode:** For any initial output voltage setting from 42 VDC to 58 VDC, output voltage remains constant regardless of load. This is the normal operating condition, in which loads are being supplied and batteries are float charged. Rectifiers operate in the Constant Voltage Mode unless load increases to the point where the product of load current and output voltage is approximately 4000 W, 3500 W, or 3200 W (depending on rectifier model).
- **Constant Power Mode:** As load increases above approximately 4000 W, 3500 W, or 3200 W (depending on rectifier model) (non-adjustable), output current continues to increase, but output voltage decreases as required to maintain constant output power. Rectifiers operate in the Constant Power Mode unless load continues to increase to the point where the current limit setting is reached.
- **Constant Current Mode:** If load increases to the current limit setting, output voltage decreases linearly to maintain output current at the current limit setting.

Specifications



NOTE! A current limitation can be set by the User and the output voltage level is set through the controller.

DC Output Ratings

- **Voltage:** Nominal -48.0 VDC, Positive Ground.
 - a) **Adjustment Range:** The output voltage can be set within the range of -42 VDC to -58 VDC, adjustable via the controller.
- **Output Power and Current:**
 - a) **Spec. No. 1R484000e, Model R48-4000e:** 4000 W, maximum (69.0 A @ -58 VDC to 83.3 A @ -48 VDC).
 - b) **Spec. No. 1R483500e, Model R48-3500e:** 3500 W, maximum (60.3 A @ -58 VDC to 72.9 A @ -48 VDC).
 - a) **Spec. No. 1R483200, Model R48-3200 and Spec. No. 1R483200e, Model R48-3200e:** 3200 W, maximum (55.2 A @ -58 VDC to 66.6 A @ -48 VDC).
- **Output Characteristics:** Refer to **Figure 1**, **Figure 2**, **Figure 3**, and **Figure 4** for graphs of rectifier output voltage vs. output current.

- **Power Derating Based on Input Voltage:** The rectifier power varies with changes in input voltage and output voltage. It uses an advanced power limitation method. The lower input threshold is 85 VAC. The rectifier can provide its maximum rated power (4000 W, 3500 W, or 3200 W) as long as the input voltage is within the range of 176 VAC to 290 VAC (R48-3200, R48-3200e) or 176 VAC to 305 VAC (R48-3500e) or 185 VAC to 305 VAC (R48-4000e). Below 176 VAC (R48-3200, R48-3200e, R48-3500e) or 185 VAC (R48-4000e), and down to 85 VAC, the rectifier will continue to operate normally but will be in a power derating mode.
 - a) R48-4000e (1R484000e): See **Figure 5**.
 - b) R48-3500e (1R483500e): See **Figure 6**.
 - c) R48-3200e (1R483200e): See **Figure 7**.
 - a) R48-3200 (1R483200): See **Figure 8**.
- **Power Derating Based on Temperature:** The rectifier delivers full power when operating at an ambient temperature of +45 °C (+113 °F) or below. Each rectifier continuously monitors the ambient temperature surrounding the power conversion circuit. If this temperature for any reason (such as a high ambient temperature or failed fan) increases above approximately +45 °C (+113 °F), the rectifier will not shut down. Rather, the rectifier limits its maximum output power to maintain the temperature of the power conversion circuit within design parameters. Operation between +45 °C (+113 °F) and +75 °C (+158 °F) will result in output power being decreased. Full power capability is restored when the temperature decreases to below approximately +45 °C (+113 °F). Refer to **Figure 9, Figure 10, Figure 11, and Figure 12** to view the relationship between the output power and the ambient temperature.
 - a) Rectifier 1R484000e provides a minimum of 3200 watts at 65 °C and from 48.0 VDC to 58.0 VDC.
 - b) Rectifier 1R483500e provides a minimum of 2700 watts at 65 °C and from 48.0 VDC to 58.0 VDC.
 - c) Rectifiers 1R483200 and 1R483200e provide a minimum of 2320 watts at 65 °C and from 48.0 VDC to 58.0 VDC.



WARNING! The module is rated for continuous operation at full output power up to +45 °C (+113 °F). Operation between +45 °C (+113 °F) and +75 °C (158 °F) will result in output power decrease. Operation above +75 °C (+158 °F) is considered abnormal and should be used on a temporary¹ basis only.

¹ **Temporary Operation at Abnormal Temperature:** Temporary operation is defined as a period of not more than eight consecutive hours per day, and a total of not more than 15 days in a year. (This refers to a total of 120 hours in any given year, but no more than 15 occurrences in that one-year period.)

Figure 1: Output Voltage vs. Output Current [R48-4000e (1R484000e)]

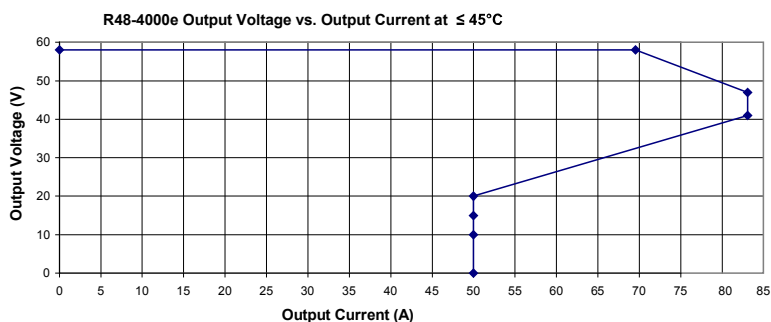

Figure 2: Output Voltage vs. Output Current [R48-3500e (1R483500e)]

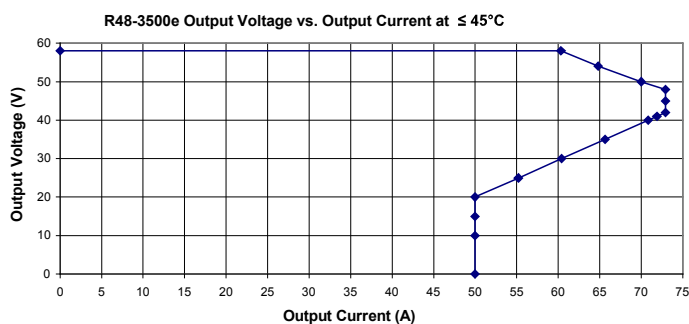

Figure 3: Output Voltage vs. Output Current [R48-3200e (1R483200e)]

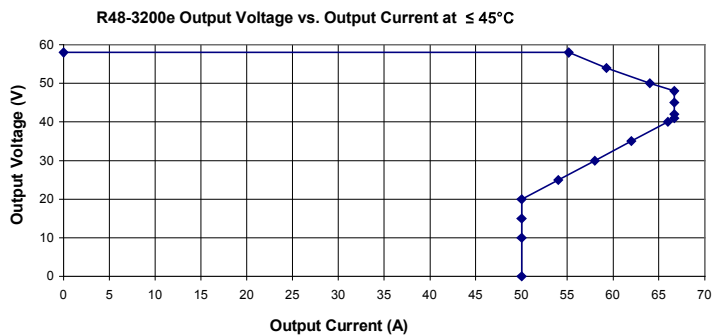

Figure 4: Output Voltage vs. Output Current [R48-3200 (1R483200)]

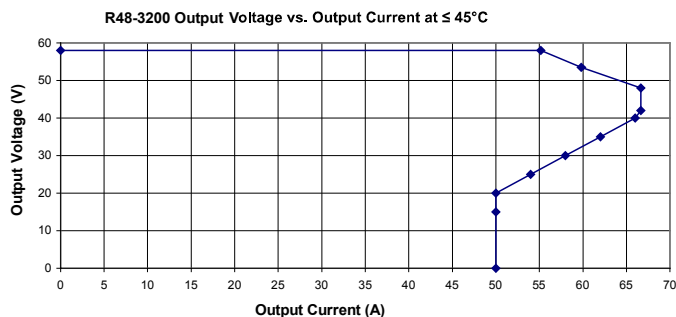

Figure 5: Power Derating Based on Input Voltage (R48-4000e [1R484000e])

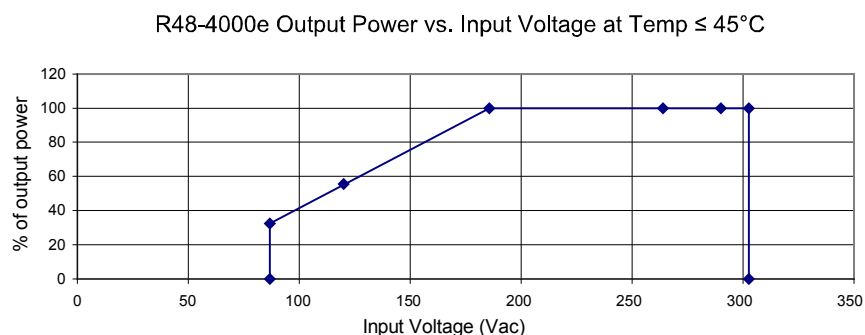

Figure 6: Power Derating Based on Input Voltage (R48-3500e [1R483500e])

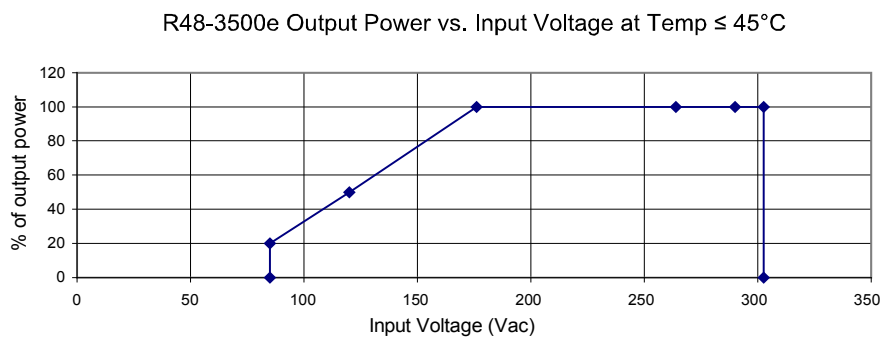

Figure 7: Power Derating Based on Input Voltage (R48-3200e [1R483200e])

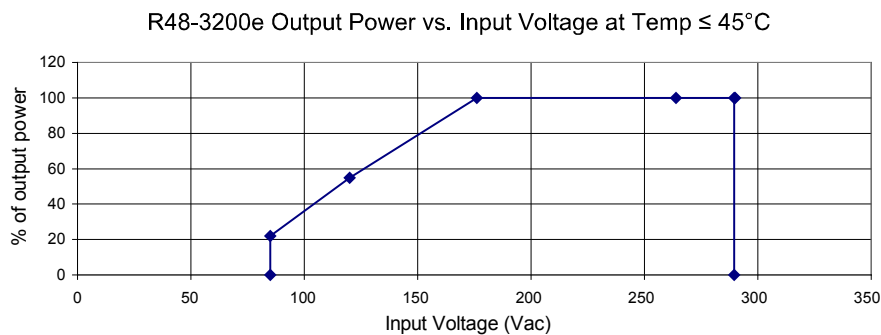

Figure 8: Power Derating Based on Input Voltage (R48-3200 [1R483200])

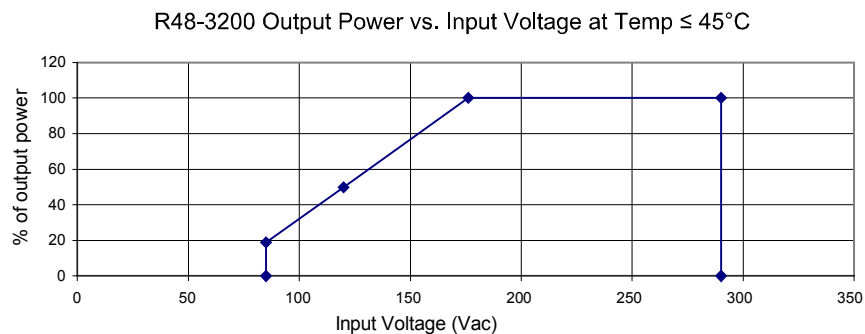

Figure 9: Typical Thermal Power Limit Curve (R48-4000e [1R484000e])

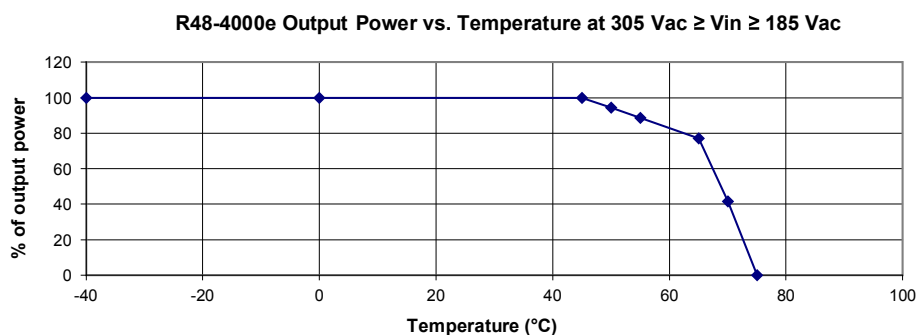

Figure 10: Typical Thermal Power Limit Curve (R48-3500e [1R483500e])

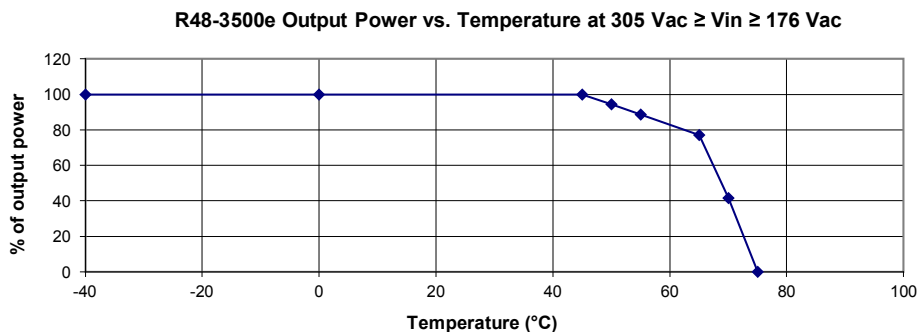

Figure 11: Typical Thermal Power Limit Curve (R48-3200e [1R483200e])

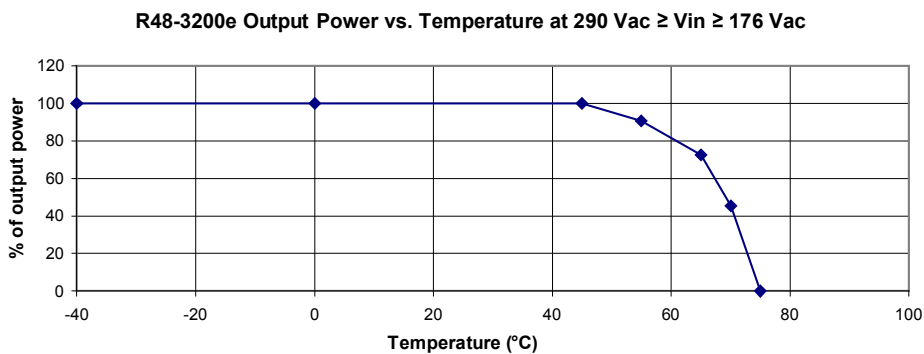
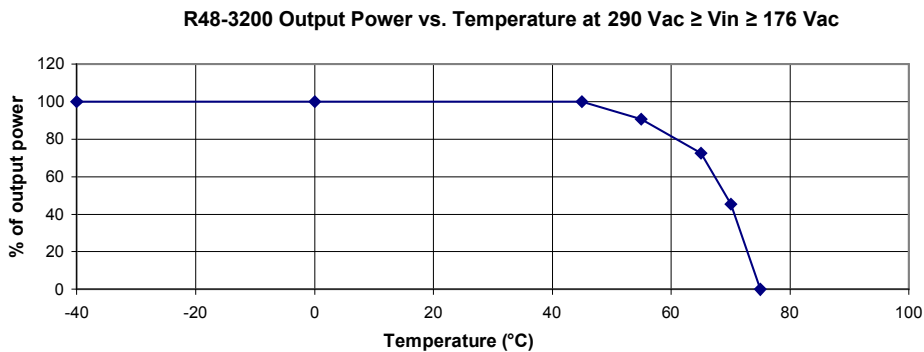

Figure 12: Typical Thermal Power Limit Curve (R48-3200 [1R483200])



- Regulation:

- a) Output Voltage Tolerance:

Output voltage tolerance:

< ± 0.2%	25 A load	+15 °C to +35 °C
< ± 0.5%	25 A load	-5 °C to +55 °C

Static regulation, including input voltage variation and temperature variation:

< ± 0.5%	5% to 100% load	+15 °C to +35 °C
< ± 1%	5% to 100% load	-5 °C to +55 °C

U_{in} = 176 VAC to 290 VAC for R48-3200 and R48-3200e, 176 VAC to 305 VAC for R48-3500e, 185 VAC to 305 VAC for R48-4000e, f = 45 Hz to 65 Hz

Output voltage decreases with increased output current.

Overshoot of output voltage at startup $\leq \pm 1\%$.

- b) Dynamic Response Characteristic (at rated input and output voltage):

Response time ≤ 200 us and overshoot $\leq 5\%$ for load changes at 50% - 25% - 50% and 50% - 75% - 50%.

Overshoot or undershoot $\leq 5\%$ and output recovers within $\pm 1\%$ of regulation band in ≤ 4 ms for load changes at 10% - 90% and 90% - 10%. (Telcordia GR-947.)

- Filtering (with or without battery):

- a) Voice Band Noise: Complies with Telcordia GR-947-CORE.

1. R48-3200, R48-3200e, R48-3500e: Output noise according to Telcordia GR-947-CORE: < 32 dBrnC between 180 VAC ~ 290 VAC input and 10% to 100% load (output voltage > 42 V, for any application with > 1 rectifier).
2. R48-4000e: Output noise according to Telcordia GR-947-CORE: < 38 dBrnC between 180 VAC ~ 290 VAC input and 20% to 70% load (output voltage > 42 V, for any application with > 1 rectifier).
3. R48-3200, R48-3200e, R48-3500e: Psophometric noise is ≤ 1 mV between 180 VAC ~ 290 VAC input and 10% to 100% load (output voltage > 42 V) and 16.66 Hz to 6000 Hz. (for any application with > 1 rectifier).
4. R48-4000e: Psophometric noise is < 2 mV between 180 VAC ~ 290 VAC input and 20% to 70% load (output voltage > 42 V) and 16.66 Hz to 6000 Hz. (for any application with > 1 rectifier).

- b) Wide Band Noise: Complies with Telcordia GR-947-CORE.

1. Typically 130 millivolt peak-to-peak. Does not exceed 250 millivolt peak-to-peak.
2. Typically 13 millivolts rms. Does not exceed 30 millivolt rms.

- Output Discharge: The output capacitors automatically discharge when the rectifier is disconnected from the batteries and AC is turned OFF. Time constant is less than 1 minute.

- **Power Interruption:** The rectifier starts when connected to a fully discharged battery or capacitor bank (bus voltage > 15 V) without operating protective devices or requiring the shedding of load or needing any manual intervention. The rectifier starts under all line and environmental conditions, when the output terminals are connected to an impedance of less than 15 milliohms.
- **Stability Criteria:** Complies with GR947 Core R3-20. Stability criteria: > 30 deg. of phase margin when gain is unity (0 dB) and gain down to < - 6 dB when phase is 180 deg.

AC Input Ratings

- **1R484000e Voltage:** Nominal 208 VAC / 240 VAC / 277 VAC, single phase, 50 Hz / 60 Hz, with an operating range of 185 VAC to 305 VAC. Acceptable input frequency range is 45 Hz to 65 Hz.
- **1R483500e Voltage:** Nominal 208 VAC / 240 VAC / 277 VAC, single phase, 50 Hz / 60 Hz, with an operating range of 176 VAC to 305 VAC. Acceptable input frequency range is 45 Hz to 65 Hz.
- **1R483200/1R483200e Voltage:** Nominal 208 VAC /240 VAC, single phase, 50 Hz / 60 Hz, with an operating range of 176 VAC to 290 VAC. Acceptable input frequency range is 45 Hz to 65 Hz.
- **Safe Voltage:** The system can tolerate 415 VAC without damage.
- **Harmonic Content (THD):** < 5% THD at 50% - 100% load. The voltage source must have a voltage THD of < 1.1%.

The rectifier complies with EN61000-3-2.

- **Inrush Current:** Peak does not exceed 1.5 times the steady state peak value of the input current at full load, nominal input voltage, and for any duration of AC input interrupts. Under the above conditions, standard AC distribution circuit breakers will not trip.

- Typical Input Data (1R484000e): 60 Hz input.
 - a) System output is initially adjusted to 53.5 VDC as measured at the system sense points at 50% of full load and nominal input. “Percent of Full Load” refers to percent of 74.7 amperes.

Nominal Input Voltage	Percent of Full Load	Input Current (Amperes)	Input VA	Input Watts	Power Factor	Efficiency %	Heat Dissipation BTU/Hr
208	10	2.194	457.92	435.10	0.950	92.18	116.1257
	30	6.109	1271.20	1255.45	0.988	94.70	201.3862
	50	10.138	2102.68	2094.08	0.996	95.02	343.7722
	70	14.312	2958.40	2952.19	0.998	94.47	557.1881
	80	16.454	3395.71	3389.90	0.998	93.99	695.3344
	90	18.645	3841.68	3835.70	0.998	93.55	861.3961
	100	20.885	4298.34	4292.11	0.998	93.36	1064.971
240	10	1.941	467.48	432.73	0.926	92.68	108.1087
	30	5.324	1279.22	1251.30	0.978	95.75	187.0544
	50	8.767	2101.49	2085.36	0.992	95.38	314.5833
	70	12.329	2947.99	2937.02	0.996	94.96	505.2075
	80	14.152	3379.85	3370.42	0.997	94.60	628.0714
	90	16.021	3820.50	3811.89	0.998	94.20	780.5918
	100	17.915	4266.63	4258.59	0.998	93.36	950.5522
277	10	1.762	490.21	431.00	0.879	93.06	102.0867
	30	4.643	1289.53	1247.46	0.967	96.13	173.7077
	50	7.607	2108.78	2078.65	0.986	96.10	290.8691
	70	10.647	2945.46	2924.85	0.993	95.53	462.1862
	80	12.201	3372.95	3355.44	0.995	95.09	577.1815
	90	13.782	3806.88	3791.54	0.996	94.66	711.7225
	100	15.388	4246.35	4232.67	0.997	94.12	860.98

- b) Maximum Input Current: at 100% of full load with output adjusted to 58 VDC as measured at the shelf output terminals.

Nominal Input Voltage	Input Voltage	Input Current (Amperes)
208/240	176	24.7
277	235	18.0

- Typical Input Data (1R483500e): 60 Hz input.
 - a) System output is initially adjusted to 54.48 VDC as measured at the system sense points at 50% of full load and nominal input. “Percent of Full Load” refers to percent of 60 amperes.

Nominal Input Voltage	Percent of Full Load	Input Current (Amperes)	Input VA	Input Watts	Power Factor	Efficiency %	Heat Dissipation BTU/Hr
208	0	0.42	87	11	0.125	--	34.5
	25	4.20	872	853	0.977	95.28	132.7
	50	8.20	1700	1690	0.994	96.00	221.2
	75	12.34	2553	2546	0.997	95.48	378.6
	100	16.66	3441	3435	0.998	94.31	651.1
	110	18.32	3781	3775	0.998	93.68	800.1
	120	18.36	3790	3782	0.998	93.29	854.6
240	0	0.49	118	11	0.920	--	34.2
	25	3.66	877	850	0.969	95.59	123.2
	50	7.11	1704	1684	0.988	96.34	201.0
	75	10.65	2547	2535	0.995	95.86	343.9
	100	14.34	3423	3414	0.997	94.90	576.4
	110	15.75	3758	3748	0.997	94.36	703.8
	120	15.79	3768	3757	0.997	93.91	765.4
277	0	0.54	149.6	8.6	0.572	--	29.35
	25	3.09	856.4	840.6	0.982	96.29	212.11
	50	6.1	1691.8	1675	0.990	96.29	212.11
	75	9.15	2535.6	2524.8	0.996	95.77	364.85
	100	12.26	3394.5	3388.8	0.998	94.94	584.78
	110	13.58	3753.8	3748	0.988	94.51	702.18
	120	13.58	3753.9	3748.9	0.994	94.52	700.84

- b) Maximum Input Current: at 100% of full load with output adjusted to 58 VDC as measured at the shelf output terminals.

Nominal Input Voltage	Input Voltage	Input Current (Amperes)
208/240/277	176	21.60

- Typical Input Data (1R483200e): 60 Hz input.

a) System output is initially adjusted to 54.48 VDC as measured at the system sense points at 50% of full load and nominal input. “Percent of Full Load” refers to percent of 55 amperes.

Nominal Input Voltage	Percent of Full Load	Input Current (Amperes)	Input VA	Input Watts	Power Factor	Efficiency %	Heat Dissipation BTU/Hr
208Vac (60Hz)	0	0.397	82.6	9	0.111	--	30.72
	25	3.7451	779.7	773.8	0.992	95.49	119.04
	50	7.4189	1543.9	1540.7	0.998	95.86	217.91
	75	11.2183	2325.1	2323.2	0.999	95.23	378.51
	100	15.0624	3118.6	3118.1	0.999	94.38	597.58
	110	16.551	3418.3	3417.9	0.999	93.93	707.78
	120	16.5356	3419	3418.3	0.999	93.91	710.44
240Vac (60Hz)	0	0.4651	111.8	8.8	0.804	--	30.03
	25	3.2515	780.2	772.1	0.990	95.74	112.17
	50	6.4286	1545.1	1536.3	0.994	96.14	202.43
	75	9.6608	2318.1	2313.3	0.998	95.65	343.73
	100	12.963	3103.8	3100.5	0.999	94.92	537.14
	110	14.2095	3399.5	3397.2	0.999	94.50	637.95
	120	14.2234	3402.7	3399.9	0.999	94.50	638.09

b) Maximum Input Current: at 100% of full load with output adjusted to 58 VDC as measured at the shelf output terminals.

Nominal Input Voltage	Input Voltage	Input Current (Amperes)
208/240	176	19.30

- Typical Input Data (1R483200): 60 Hz input.

a) System output is initially adjusted to 54.48 VDC as measured at the system sense points at 50% of full load and nominal input. “Percent of Full Load” refers to percent of 55 amperes.

Nominal Input Voltage	Percent of Full Load	Input Current (Amperes)	Input VA	Input Watts	Power Factor	Efficiency %	Heat Dissipation BTU/Hr
208	0	0.62	127	69	0.542	--	235.25
	25	4.13	856	842	0.988	88.9	319.31
	50	7.92	1644	1639	0.997	91.0	479.51
	75	11.87	2457	2453	0.998	91.6	701.88
	100	16.02	3298	3297	0.998	90.9	1020.09
	110	17.28	3561	3558	0.998	90.5	1156.27
	120	16.88	3478	3477	0.998	89.9	1208.42
240	0	0.68	163	66	0.612	--	225.31
	25	3.65	865	846	0.977	88.7	325.42
	50	6.89	1648	1633	0.994	91.9	453.62
	75	10.23	2445	2441	0.998	92.1	654.78
	100	13.68	3269	3265	0.998	91.8	917.81
	110	14.84	3538	3534	0.998	91.3	1050.24
	120	14.46	3455	3454	0.998	90.5	1118.21

b) Maximum Input Current: at 100% of full load with output adjusted to 58 VDC as measured at the shelf output terminals.

Nominal Input Voltage	Input Voltage	Input Current (Amperes)
208/240	176	20.42

Figure 13: Efficiency Curve [R48-4000e (1R484000e)]

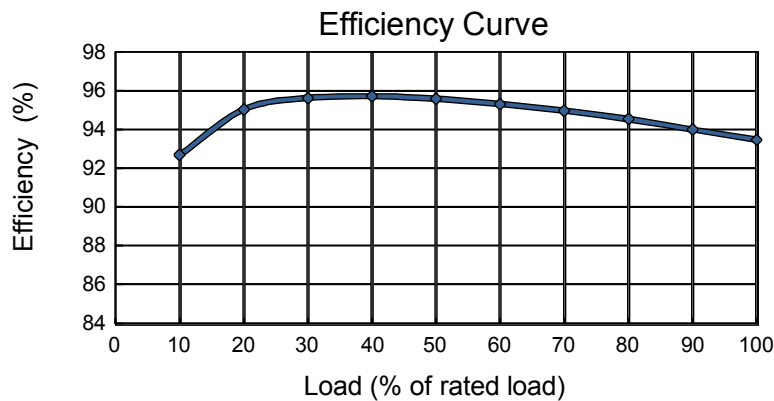
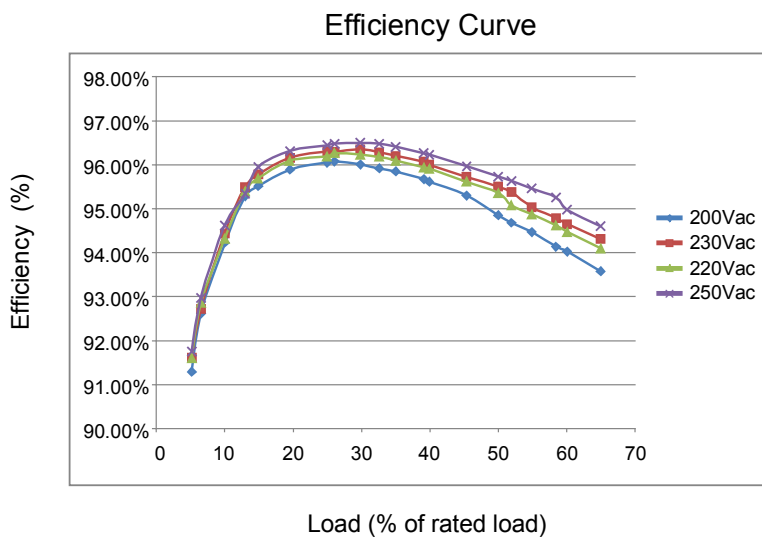

Figure 14: Efficiency Curve [R48-3500e (1R483500e)]



Environmental Ratings

- Operating Ambient Temperature Range:
 - a) -40 °C (-40 °F) to +75 °C (+167 °F) with derating output.
 - b) -40 °C (-40 °F) to +45 °C (+113 °F) with full power performance.
 - c) Temperature Coefficient: 0.01% per degrees Celsius.
- Storage Ambient Temperature Range: -40 °C (-40 °F) to 75 °C (+167 °F).
- Relative Humidity: This rectifier is capable of operating in an ambient relative humidity range of 0% to 95%, non-condensing.
- Altitude: 2000 m (6560 ft) at full power (power limited for heights above 2000 m).

- Surge Protection: Compliance with EN61000-4-5 Installation Class 4, and capable of withstanding surges per ANSI/IEEE C 62.41 1999 Category B3 across the input terminals.



NOTE! *This level of protection is a widely used standard for telecommunications power equipment. As with all such equipment, it is the end user's responsibility to provide an adequately sized Surge Suppression Device at the commercial power service entrance of the building that reduces all incoming surges to levels below the classes/categories stated for the equipment.*

- Ventilation Requirements: The rectifiers are fan cooled and utilize front to back forced ventilation. A rectifier must be mounted so ventilating openings are not blocked and temperature of the air entering the rectifier does not exceed the Operating Ambient Temperature Range stated above.
- Single Rectifier Audible Noise:
 - a) At 25 °C ≤ 53 dB(A) with fan in high speed; Measurement made at 0.6 m distance in front of rectifier and at same horizontal line of the middle of rectifier.
 - b) At 25 °C ≤ 45 dB(A) with fan in low speed; Measurement made at 1 m distance in front of rectifier and at same horizontal line of the middle of rectifier.
- EMI/RFI Suppression:
 - a) Rectifiers operating in an approved rectifier Mounting Shelf conform to the requirements of FCC rules Part 15, Subpart B, Class B for Radiated and Conducted emissions limits.
 - b) Rectifiers operating in an approved rectifier Mounting Shelf conform to the requirements of European Norm, EN55022, Class B for Radiated and Conducted emissions limits.

Compliance Information:

- Safety Compliance: This unit meets the requirements of UL 60950-1, Standard for Information Technology Equipment, and is UL Recognized as a power supply for use in Telephone, Electronic Data Processing or Information Processing Equipment. This unit meets the requirements of CAN/CSA 22.2, No. 60950-00 and is tested and Certified by UL ("c UR") as a Component Type Power Supply.
- The rectifiers are RoHS compliant, 5/6.

Standard Features

- Type of Power Conversion Circuit: High frequency.
- Constant Voltage Mode: For any initial output voltage setting from 47 VDC to 58 VDC, output voltage remains constant regardless of load. This is the normal operating condition, in which loads are being supplied and batteries are float charged. Rectifiers operate in the Constant Voltage Mode unless load increases to the point where the product of load current and output voltage is approximately 4000 W, 3500 W, or 3200 W (depending on rectifier model).
- Constant Power Mode: As load increases above approximately 4000 W, 3500 W, or 3200 W (depending on rectifier model) (non-adjustable), output current continues to increase, but output voltage decreases as required to maintain constant output power. Rectifiers operate in the Constant Power Mode unless load continues to increase to the point where the current limit setting is reached.
- Constant Current Mode: If load increases to the current limit setting, output voltage decreases linearly to maintain output current at the current limit setting.

- Input Protection:
 - a) Fuse: On the input, two UL recognized fuses are used, not user-replaceable.
 - b) Input Voltage Protection: Derating from 85 VAC to 176 VAC (R48-3200, R48-3200e, R48-3500e) or 85 VAC to 185 VAC (R48-4000e). Withstand 415 VAC input without damage.
 1. The rectifier will shut down at low or high voltage input; low voltage disable point: 80 V \pm 3 V; Hysteresis at least 15 VAC for restart. High voltage disable point: 295 V \pm 5 V for R48-3200 and R48-3200e, 310 V \pm 5 V for R48-3500e and R48-4000e; Hysteresis at least 10 VAC for restart.
 2. Between 85 VAC to 176 VAC (R48-3200, R48-3200e, R48-3500e) or 85 VAC to 185 VAC (R48-4000e) the output power will be derated linearly according to input voltage per **Figure 5**, **Figure 6**, **Figure 7**, and **Figure 8**.
 3. Over Voltage Isolation: The rectifier will be disconnected from the AC input when a preset non-adjustable value is reached.
- AC Fail Alarm: The rectifier issues an "AC Fail Alarm" when AC input voltage drops below 164 VAC. This alarm clears when AC input voltage recovers above 169 VAC. This level can be set by the controller.
- Output Protection:
 - a) Overload / Reverse Current: An output fuse is provided on each rectifier. This fuse is not customer replaceable. The rectifier can be plugged into or pulled out of a shelf while operating, without damage or opening the fuse.
 - b) Current Limiting: The maximum current delivered by the rectifier can be set via the controller from 10% to 121% of its rating at maximum rated output voltage. Output Current Limit Error: $\leq \pm 1.5$ A.
 - c) High Voltage Shutdown:
 1. Adjustable Control: If rectifier output voltage exceeds an adjustable preset value and the rectifier is delivering more than 10% of its rated current, the rectifier shuts down. (Adjustable from 56 VDC to 59 VDC via the controller. The restart hysteresis is 0.5 V \pm 0.2 V.)

 The rectifier then restarts and a HVSD restart timer starts (time value configurable via the controller, factory default is 5 minutes). If output voltage again exceeds the high voltage shutdown value before the HVSD restart timer expires, the rectifier shuts down and locks out. Manual restart is then required (by turning power to the rectifier off or by removing the rectifier, waiting until the LEDs on the rectifier extinguish, then turning power to the rectifier on or re-inserting the rectifier). If the rectifier does not experience a high voltage condition before the HVSD restart timer expires, the restart circuit is reset.

 If two or more rectifiers are paralleled, only the rectifier causing the high voltage condition shuts down.
 2. Backup: If rectifier output voltage exceeds 59.5 V \pm 0.5 V (non-adjustable) and the rectifier is delivering more than 10% of its rated current, the rectifier shuts down. The rectifier then restarts and a HVSD restart timer starts (time value configurable via the controller, factory default is 5 minutes). If output voltage again exceeds the high voltage shutdown value before the HVSD restart timer expires, the rectifier shuts down and locks out. Manual restart is then required (by turning power to the rectifier off or by removing the rectifier, waiting until the LEDs on the rectifier extinguish, then turning power to the rectifier on or re-inserting the rectifier).

- Over-Temperature Protection: The rectifier provides over temperature protection by derating output power and recovers automatically.
- Active Load Sharing: The rectifier uses advanced digital active load sharing technology that maintains balancing to within 3% of rated current.
- Hot Swappable: The rectifier is designed to be plug-and-play. The rectifier can be inserted or removed from a live DC power system with no damage. When the rectifier is plugged into the system, the system output voltage will not be affected.
- High Temperature Alarm: Each rectifier continuously monitors the ambient temperature surrounding the power conversion circuit. If this temperature exceeds a preset non-adjustable value, local and extended rectifier Fail alarms are activated. The alarms will automatically be removed when the ambient temperature surrounding the power conversion circuit decreases to below a preset non-adjustable value.
- Cooling: Each rectifier contains a fan for front-to-back force air-cooling.
 - a) Fan Fault Protection: The rectifier shuts down and its alarm indicator (red) flashes if the fan fails. Fan failure is detected and reported to controller. The fans are field replaceable.
 - b) Fan Control: Fan speed is continuously variable. When input voltage is within normal range, the built-in processor adjusts fan speed according to the rectifier Module's internal temperature and output power. For example, a higher temperature or output power increases the fan speed. This feature can be disabled via the controller, allowing the fan to run at full speed regardless of temperature.
- Paralleling: This rectifier may be connected in parallel with any rectifier of the same polarity and adjusted to the same output voltage.
- Output Current Walk-In:
 - a) Normal Start:
 1. Start up time, defined as beginning at AC switch on and ending when full output power has been reached, consists of two time intervals, the delay period and the output voltage rampup period.
 2. During the delay period the output voltage will be zero.
 3. Start up time (AC on, till full power): ≤ 5 seconds.
 4. Output voltage ramp up period, t : $50 \text{ ms} \leq t \leq 150 \text{ ms}$. (10% to 90% of full power)
 5. The rectifier will not suffer any damage, when subjected to repetitive AC switch on / switch off operations.
 - b) Current Walk-In (if enabled via controller):
 1. 90% load in $> 8 \text{ S}$, 100% load in $< 124 \text{ s}$.
 2. According to Telcordia GR-947-CORE, R3-19.

- Communication Failure: The rectifier's protection indicator (yellow) will flash should it experience a communication failure. The failure information will be reported to the controller and the controller will process the failure accordingly. During a communication failure, in order to protect the battery, the rectifier output voltage will automatically be adjusted as follows.
 - The rectifier default factory output voltage is 53.5 V.
 - Once power is applied to the rectifier and the rectifier is recognized by the controller, the output voltage is updated to the setting programmed into the controller.
 - If communications with an SCU+ controller is lost, rectifier output voltage goes to a default value programmed into the controller (this is a separate programmable parameter from the output voltage setting).
 - If communications with an ACU+ or NCU controller is lost, rectifier output voltage goes to the last communicated float output voltage setting in the controller (the last communicated float output voltage setting is stored in the rectifier).
 - The rectifier will revert to normal operation once normal communication to the controller is restored.
- Rectifier Output Current Imbalance:
 - a) When the average current of all rectifier modules is greater than 20% of full rated current, and the difference between local rectifier current and average current is greater than 16% of full rated current, the yellow protection indicator will illuminate.
 - b) When the average current of all rectifier modules is greater than 20% of full rated current, and local rectifier current is less than 2% of full rated current, then the red fault indicator will illuminate.
- Monitoring Function: The rectifier has a built-in advanced DSP that monitors and controls the operation of the rectifier. The DSP also communicates with the controller in real time through the CAN bus. **Table 1** lists the different commands and information exchanged between the rectifier and the controller.
- External Control Circuits: Provided via the associated controller. Refer to the separate Power System documentation for a complete description of available external control circuits.
- External Alarm Circuits: Provided via the associated controller. Refer to the separate Power System documentation for a description of available external alarms.

Mechanical Specifications

- Dimensions:
 - a) Millimeters: 132.0 (Height) X 85.3 (Width) X 287.0 (Depth)
 - b) Inches: 5.20 (Height) X 3.36 (Width) X 11.3 (Depth)
- Weight: 3.5 kg (7.7 lbs).
- Indicators:
 - a) Power (Green)
 - b) Protection (Yellow)
 - c) Alarm (Red)

Table 1: Exchange of Information between Rectifier and Controller

Commands / signals that can be received by the Rectifier Module from the Controller.	Information gathered by the Controller from the Rectifier Module.
<ul style="list-style-type: none"> • Turn On/Off • Current Walk-in On/Off • HVSD (High Voltage Shutdown) Reset • Current Limit Adjustment • Voltage Regulation 	<ul style="list-style-type: none"> • Input Voltage • Output Voltage • Output Current • Current Limit Setting • Temperature • Over Voltage Setting • On/Off Status • Fault Alarms, such as: HVSD Fan Fail • Protection Alarms, such as: Input Voltage Protection Inner DC Bus Voltage Protection High Temperature Protection • Thermal Derating • AC Derating • AC Fail • Imbalance Output Current • Address • Code • Date • Software Version • Hardware Version

OPERATION

AC Input Protection Device Requirements/Recommendations

Refer to the system documentation supplied with the system the rectifier is installed in.

Local Indicators

Location and Identification: Refer to **Figure 15**.

Description: There are three (3) indicators located on the rectifier’s front panel. The functions of these indicators are as shown in **Table 2**.

 **NOTE!** DC voltage must be present at the rectifier output terminals (from battery or an operating rectifier) or AC voltage at the input terminals.

Figure 15: Local Indicator Locations

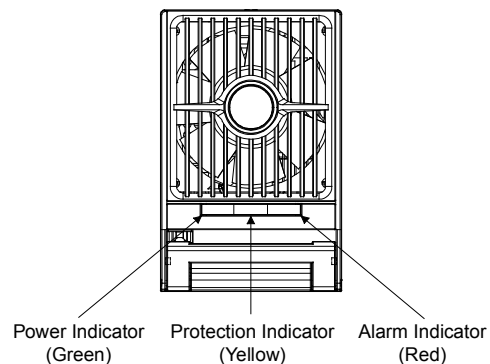





Table 2: Local Indicators

Indicator		Normal State	Alarm State	Alarm Cause
	Power (Green)	On	Off	No input voltage. Internal input fuse open.
			Flashing	The rectifier is being identified by the controller.
	Protection (Yellow)	Off	On	AC input under/over voltage. PFC output under/over voltage. Moderate load sharing imbalance. Rectifier not inserted into the slot completely. Rectifier in ECO Standby Mode when ECO Mode is active in controller.
			Flashing	Loss of communication with the controller (the rectifier can provide power).
	Alarm (Red)	Off	On	Severe load sharing imbalance. Rectifier output disabled for any reason, including overvoltage shutdown and internal output fuse open. Rectifier addresses contradictory.
			Flashing	Fan not operating (rectifier module shuts down).

Rectifier High Voltage Shutdown and Lockout Restart

Procedure

1. Turn the power to the rectifier off or remove the rectifier, wait 30 seconds or more (until the LEDs on the rectifier extinguish), then turn the power to the rectifier on or re-insert the rectifier.

Installing Rectifiers

The rectifier is hot swappable. It can be installed with the system operating.

CAUTION! This rectifier module contains Double pole fusing; parts of the equipment that remain energized might represent a hazard during servicing after operation of the fuse. If the rectifiers are connected to a 3-phase system, the neutral line should also have a fuse.

WARNING! To prevent damage to the latching mechanism, ensure the handle is in the open position when installing or removing a module. NEVER hold the handle in the closed position when installing a module into a shelf.

Procedure



NOTE! Refer to **Figure 16** as this procedure is performed.

1. Place the rectifier into an unoccupied mounting slot without sliding it in completely.
2. Click the rectifier handle in order to pop it forward out of the rectifier's front panel (this will also retract the latch mechanism located on the underside of the rectifier). Refer to **Figure 16** for latch mechanism illustration.
3. Push the rectifier completely into the shelf.
4. Push the handle into the front panel of the rectifier. This locks the rectifier securely to the shelf.
5. Repeat the above steps for each rectifier being installed in the system.
6. After the rectifiers are physically installed in the mounting shelf(s), they are ready for operation immediately after power is supplied to them.
7. Certain functions (i.e. rectifier current limit, rectifier addressing) may require adjustment when adding or replacing a rectifier Module. Refer to the Power System documentation for instructions.

Figure 16: Installing a Rectifier

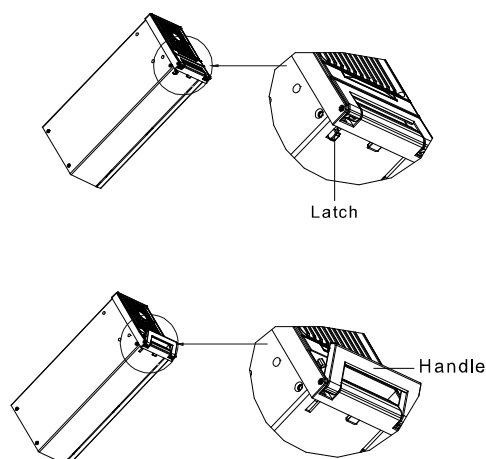

TROUBLESHOOTING AND REPAIR

Troubleshooting

Rectifier Current Sharing Imbalance

When multiple rectifiers are operating in parallel and the load is greater than 10%, if the current sharing imbalance among them is greater than 3%, check if the rectifier is properly seated in the shelf.



If the current sharing imbalance still persists following the verification suggested above, replace the rectifier exhibiting the current imbalance.

Rectifier Fault Symptoms and Troubleshooting

The fault indicators that can be displayed by the rectifier are as follows. Refer to **Table 3** for a list of possible causes and corrective actions.

- Power Indicator (Green) OFF
- Protection Indicator (Yellow) ON
- Protection Indicator (Yellow) Flashing
- Alarm Indicator (Red) ON
- Alarm Indicator (Red) Flashing

Table 3: Rectifier Troubleshooting

Symptom		Possible Cause(s)	Suggested Action(s)
	Power Indicator (Green) Off	No input voltage.	Make sure there is input voltage.
		Internal input fuse open.	Replace the rectifier.
	Protection Indicator (Yellow) On	AC input under/over voltage.	Correct the AC input voltage to within the acceptable range.
		PFC under/over voltage.	Replace the rectifier.
		Moderate load sharing imbalance.	Check if the rectifier is properly seated in the shelf. If this does not correct the fault, replace the rectifier.
		Rectifier not inserted into the slot completely.	Remove and properly insert the rectifier.
	Rectifier in ECO Standby Mode when ECO Mode is active in controller.	--	
Protection Indicator (Yellow) Flashing	Loss of communication with controller (the rectifier can provide power).	Check the communication cables. Remove and properly insert the rectifier.	
	Alarm Indicator (Red) On	Severe load sharing imbalance. Rectifier output disabled for any reason, including overvoltage shutdown and internal output fuse open.	Turn AC power to the rectifier off or remove the rectifier, wait 30 seconds or more (until the LEDs on the rectifier extinguish), then turn the AC power to the rectifier on or re-insert the rectifier. If rectifier fails to start, shuts down again, or load sharing imbalance persists; replace the rectifier.
		Rectifier addresses contradictory.	Replace the rectifier.
	Alarm Indicator (Red) Flashing	Fan not operating (rectifier shuts down).	Replace the fan.

Replacement Procedures

Rectifier Replacement

The rectifier is hot swappable. It can be removed and installed with the system operating.

 **NOTE!** Each rectifier locks into a module mounting shelf by means of a latch located on the bottom of the module. The latch and rectifier handle are interactive. Pushing the handle up into the module's front panel causes the latch to extend to the locking position; pulling the handle down out from the module's front panel causes the latch to retract. See **Figure 16**.

 **DANGER!** Take care when removing a rectifier that was in operation, as rectifier surfaces could be very hot.

 **WARNING!** To prevent damage to the latching mechanism, ensure the handle is in the open position when installing or removing a module. NEVER hold the handle in the closed position when installing a module into a shelf.

Procedure

 **NOTE!** Refer to **Figure 16** as this procedure is performed.

1. Performing this procedure may activate external alarms. Do one of the following. If possible, disable these alarms. If these alarms cannot be easily disabled, notify the appropriate personnel to disregard any alarms associated with this system while this procedure is performed.
2. On the rectifier to be removed, click the rectifier's handle in order to pop it forward out of the rectifier's front panel. This will retract the latch mechanism located on the underside of the rectifier and thus unlock the rectifier from the shelf. Refer to **Figure 16** for latch mechanism illustration.
3. Slide the rectifier out by pulling forward.
4. Place the replacement rectifier into the mounting slot without sliding it in completely.
5. On the replacement rectifier, click the rectifier's handle in order to pop it forward out of the rectifier's front panel (this will also retract the latch mechanism located on the underside of the rectifier).
6. Push the rectifier completely into the shelf.
7. Push the handle into the front panel of the rectifier. This locks the rectifier securely to the shelf.
8. Certain functions (i.e. rectifier current limit, rectifier addressing) may require adjustment when adding or replacing a rectifier Module. Refer to the Power System documentation for instructions.
9. After the rectifiers are physically installed in the mounting shelf(s), they are ready for operation immediately after power is supplied to them. Verify that the rectifiers are operating normally.
10. Enable the external alarms, or notify appropriate personnel that this procedure is finished.
11. Ensure that there are no local or remote alarms active on the system.

Rectifier Fan Replacement

Each rectifier uses a fan (P/N 32010086 for 1R483200 rectifier module. P/N 32010109 for 1R483200e, 1R483500e, and 1R484000e rectifier module) for cooling. If fan replacement should become necessary, perform the following procedure.



CAUTION! In a system with NO redundant rectifier, battery must have sufficient reserve to power the load(s) while the rectifier is removed for fan replacement.



NOTE! When performing any step in this procedure that requires removal of existing hardware, retain all hardware for use in subsequent steps.

Procedure



NOTE! Refer to **Figure 17** as this procedure is performed.

1. Performing this procedure may activate external alarms. Do one of the following. If possible, disable these alarms. If these alarms cannot be easily disabled, notify the appropriate personnel to disregard any alarms associated with this system while this procedure is performed.
2. Remove the rectifier from the shelf. Refer to a previous procedure for step-by-step instructions.
3. Place the rectifier on a static-safe work surface. Connect an approved grounding strap to your wrist for the remainder of this procedure.
4. On this rectifier, loosen the three (3) screws on the rectifier front cover and remove the cover.
5. For proper orientation of the new fan, observe the location of the fan wires and the air flow arrows on the old fan.
6. Unplug the power cable of the old fan and remove the fan.
7. Plug the power cable of the new fan and place the new fan in the space vacated by the old fan. Ensure the fan wires and air flow arrows match the orientation of the old fan.
8. Position the rectifier front cover back into place and secure with the screws previously removed.
9. Replace the rectifier into the shelf. Refer to the previous procedure for step-by-step instructions.
10. When the fans start, check to ensure that each is providing front-to-back airflow. If air direction is wrong, immediately remove the rectifier from the shelf. Repeat previous steps to check fan orientation, and correct as necessary. Reinstall the rectifier and again check for proper airflow.
11. Enable the external alarms, or notify appropriate personnel that this procedure is finished.
12. Ensure that there are no local or remote alarms active on the system.

Figure 17: Rectifier Fan Replacement

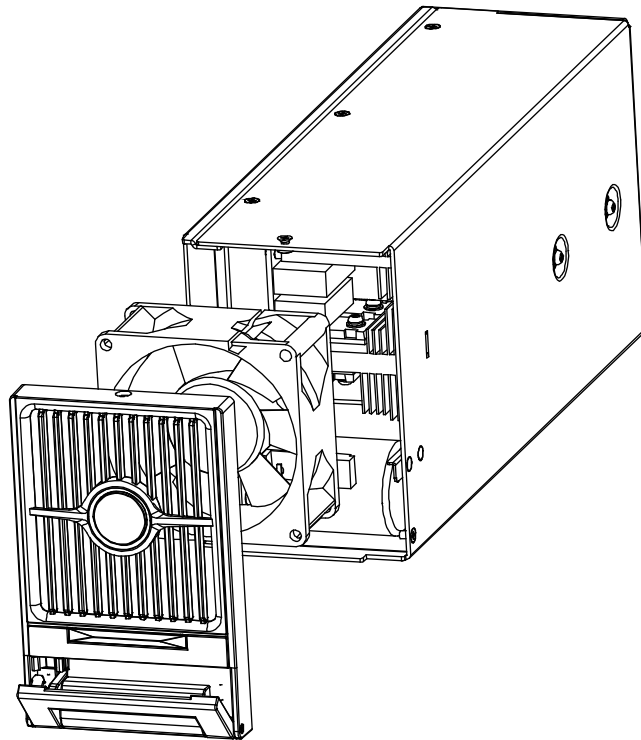

This page is intentionally blank.

