



Liebert®

GXT5 UPS

120 V Input, 120 V Output

LV

Installer/User Guide

The information contained in this document is subject to change without notice and may not be suitable for all applications. While every precaution has been taken to ensure the accuracy and completeness of this document, Vertiv assumes no responsibility and disclaims all liability for damages resulting from use of this information or for any errors or omissions. Refer to other local practices or building codes as applicable for the correct methods, tools, and materials to be used in performing procedures not specifically described in this document.

The products covered by this instruction manual are manufactured and/or sold by Vertiv. This document is the property of Vertiv and contains confidential and proprietary information owned by Vertiv. Any copying, use or disclosure of it without the written permission of Vertiv is strictly prohibited.

Names of companies and products are trademarks or registered trademarks of the respective companies. Any questions regarding usage of trademark names should be directed to the original manufacturer.

Technical Support Site

If you encounter any installation or operational issues with your product, check the pertinent section of this manual to see if the issue can be resolved by following outlined procedures. Visit <https://www.vertiv.com/en-us/support/> for additional assistance.

Table of Contents

Important Safety Information	1
Chapter 1: GXT5 Description	3
1.1. UPS Features and Available Models	3
1.2. Front Panels	4
1.3. Rear Panels	4
1.4. Battery Cabinet	7
1.5. Major Internal Components and Operating Principle	7
1.6. UPS States and Operating Modes	9
1.6.1. Normal Mode	9
1.6.2. Bypass Mode	9
1.6.3. Battery Mode	9
1.6.4. Frequency Converter Mode	9
1.6.5. ECO Mode	10
Chapter 2: Installation	11
2.1. Unpacking and Inspection	11
2.2. Pre-installation Preparation	11
2.2.1. Installation Clearances	11
2.3. Installing the UPS	12
2.3.1. Tower Installation	12
2.3.2. Rack Installation	13
2.4. Installing External Battery Cabinets	13
2.5. Connecting AC Input Power	15
2.6. Communication Connections	16

2.6.1. Connecting IntelliSlot Communication.....	16
2.6.2. Connecting to the Dry-contact Port.....	16
2.6.3. Connecting a Remote Emergency Power-off (REPO) Switch.....	18
2.6.4. Connecting a USB Cable.....	19
2.6.5. Connecting CLI Communication Cables.....	19

Chapter 3: Operating the UPS..... 21

3.1. Silencing the Audible Alarm.....	21
3.2. Starting-up the UPS.....	21
3.3. Transferring to Battery Mode.....	22
3.4. Transferring from Normal to Bypass Mode.....	22
3.5. Transferring from Bypass to Normal Mode.....	22
3.6. Shutting-down the UPS Completely.....	23
3.7. Remote Emergency Power-off (REPO).....	23

Chapter 4: Operation and Display Panel..... 25

4.1. LED Indicators.....	27
4.2. LCD Menu and Screens.....	27
4.2.1. Start-up and Flow Screens.....	27
4.2.2. Main Menu.....	28
4.2.3. Status Screen.....	29
4.2.4. Settings Submenu.....	32
4.2.5. Control Screen.....	41
4.2.6. Log Screen.....	42
4.2.7. About Screen.....	45
4.3. Editing Display and Operation Settings.....	47
4.3.1. Settings Prompts.....	47

4.3.2. Changing the Password.....	48
4.3.3. Selecting the Display Language.....	48
4.3.4. Setting the Date and Time.....	49
Chapter 5: Maintenance.....	51
5.1. Replacing Batteries.....	51
5.2. Charging Batteries.....	53
5.3. Checking UPS Operation.....	54
5.4. Cleaning the UPS.....	54
5.5. Firmware Updates.....	54
5.5.1. Updating Firmware with RDU101 Card Connection.....	55
5.6. Updating DSP Firmware via RDU101.....	57
5.7. Updating Firmware with a CLI Connection.....	59
Chapter 6: Troubleshooting.....	63
6.1. Symptoms that Require Troubleshooting.....	63
6.2. Audible Alarm (Buzzer).....	63
6.2.1. Faults.....	64
6.3. Troubleshooting UPS Issues.....	65
Chapter 7: Specifications.....	67
7.1. Battery Run Times.....	70
Appendix I: Open Source Software Legal Notices.....	73
Appendix II: Technical Support.....	75

Important Safety Information

IMPORTANT! This manual contains important safety instructions that must be followed during the installation and maintenance of the UPS and batteries. Read this manual thoroughly and the safety and regulatory information, available at <https://www.vertiv.com/ComplianceRegulatoryInfo>, before attempting to install, connect to supply, or operate this UPS.

This page is intentionally left blank.

Chapter 1: GXT5 Description

The Liebert® GXT5 is a compact, online uninterruptible power system (UPS) that continuously conditions and regulates its output voltage. The Liebert® GXT5 supplies microcomputers and other sensitive equipment with clean sine-wave input power.

Upon generation, AC power is clean and stable. However, during transmission and distribution it is subject to voltage sags, spikes, and complete failure that may interrupt computer operations, cause data loss, and damage equipment.

The Liebert® GXT5 protects equipment from these disturbances. The Liebert® GXT5 continuously charges its batteries from the mains, enabling it to supply power to connected loads, even when the mains fail.

1.1. UPS Features and Available Models

The GXT5 includes the following features. [Table 1-1](#) below, lists the available models and power ratings.

- Enhanced load capacity with an output power factor of 1.
- Input power factor greater than 0.99.
- Optional tower or rack installation to meet varying installation requirements.
- Adapts to areas with unstable power-mains supply via high-frequency double-conversion topology structure, with high input-power factor, wide input-voltage range, and output immune to grid interference.
- Programmable terminals protect key devices when load is heavy.
- Operation and display panel with model-specific color LCD offers simple configuration and control of the UPS.
- ECO power-supply mode and smart-sleep mode help you save the maximum amount of energy.

Table 1-1 UPS Models and Power Ratings

MODEL NUMBER	NOMINAL POWER RATING @ 120 V INPUT
GXT5-500LVRT2UXL	500 VA/500 W
GXT5-750LVRT2UXL	750 VA/750 W
GXT5-1000LVRT2UXL(TAA)	1000 VA/1000 W
GXT5-1500LVRT2UXL(TAA)	1500 VA/1350 W
GXT5-2000LVRT2UXL(TAA)	2000 VA/1800 W
GXT5-3000LVRT2UXL(TAA)	3000 VA/2700 W

1.2. Front Panels

The various GXT5 models have the same general appearance, with the main difference being the receptacle types on the rear panel.

Figure 1-1 Front View



1.3. Rear Panels

The following figures detail the rear-panel features for each GXT5 model.

Figure 1-2 GXT5-500/750/1000/1500LVRT2UXL and GXT5-1000/1500LVRT2UXLTAA Rear Panel

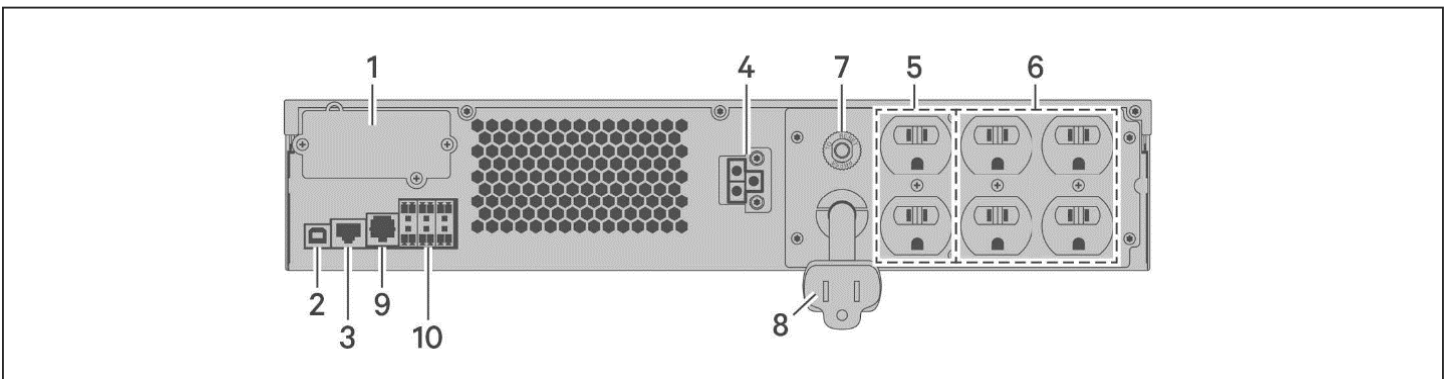

ITEM	DESCRIPTION
1	Liebert® IntelliSlot™ port
2	USB port
3	Un-used
4	External-battery connector
5	Non-programmable output receptacles, NEMA 5-15R
6	Programmable output receptacles, NEMA 5-15R
7	Input circuit breaker
8	Input-power plug and cable, NEMA 5-15P
9	R232 port, RJ-45/RJ-11 connection
10	Terminal-block communication connectors

Figure 1-3 GXT5-2000LVRT2UXL and GXT5-2000LVRT2UXLTA Rear Panel

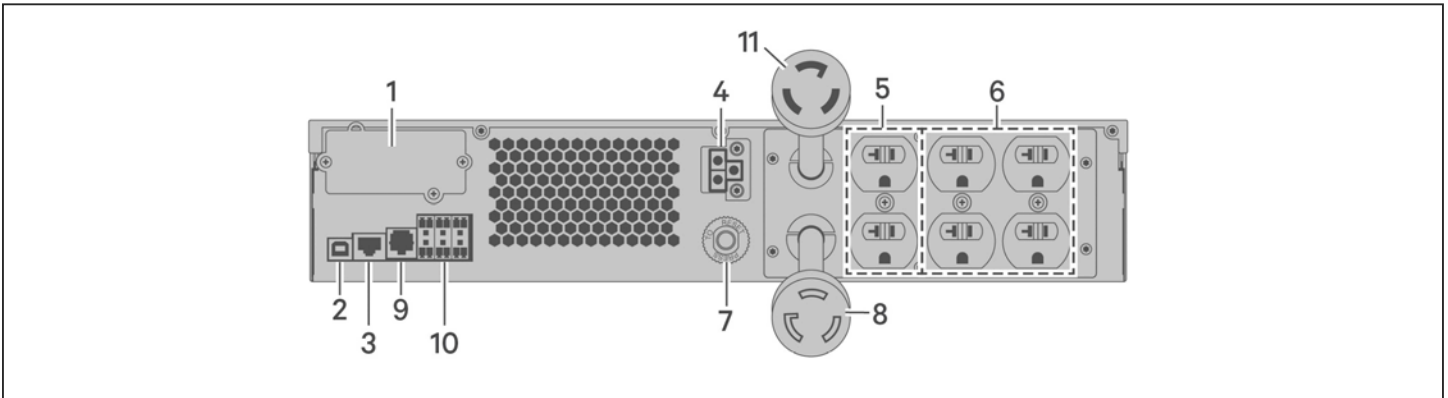

ITEM	DESCRIPTION
1	Liebert® IntelliSlot™ port
2	USB port
3	Un-used
4	External-battery connector
5	Non-programmable output receptacles, NEMA 5-20R
6	Programmable output receptacles, NEMA 5-20R
7	Input circuit breaker
8	Input-power plug and cable, NEMA L5-20P
9	R232 port, RJ-45/RJ-11 connection
10	Terminal-block communication connectors
11	Output-power plug and cable, NEMA L5-20R

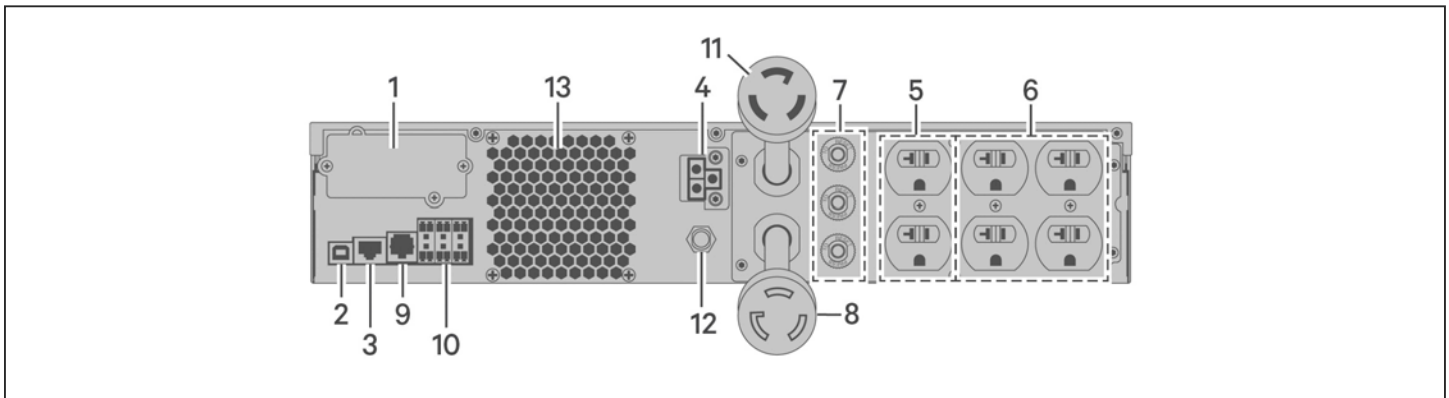
Figure 1-4 GXT5-3000LVRT2UXL and GXT5-3000LVRT2UXLTA Rear Panel

ITEM	DESCRIPTION
1	Liebert® IntelliSlot™ port
2	USB port
3	Un-used
4	External-battery connector
5	Non-programmable output receptacles, NEMA 5-20R
6	Programmable output receptacles
7	Output circuit breakers
8	Input-power plug and cable, NEMA L5-30P
9	R232 port, RJ-45/RJ-11 connection
10	Terminal-block communication connectors
11	Output-power plug and cable, NEMA L5-30R
12	Input circuit breaker
13	Cooling fan

1.4. Battery Cabinet

Optional battery cabinets are available for the UPS, and include a single battery-connector cable. Up to 10 battery cabinets may be connected in parallel to the UPS, and up to 6 can be auto-detected using EBC-detection. See [External Battery Cabinet Specifications](#) on [page 69](#), for the cabinet specifications. For approximate battery run times with additional EBCs, see [Battery Run Times](#) on [page 70](#). See [Installing External Battery Cabinets](#) on [page 13](#), to connect the cabinets.

Figure 1-5 Battery Cabinet

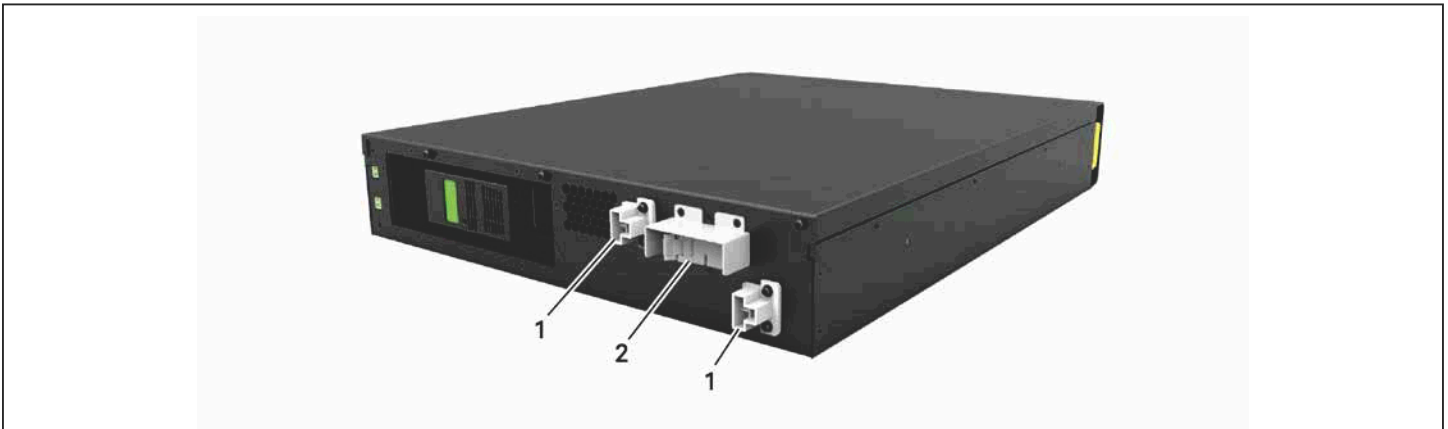

ITEM	DESCRIPTION
1	Battery connectors
2	Breaker

1.5. Major Internal Components and Operating Principle

[Figure 1-6](#) on the next page, shows the UPS operating principle. [Table 1-2](#) on the next page, describes the function of the major components in the UPS.

NOTE: [Figure 1-6](#) on the next page, is one example of basic operation.

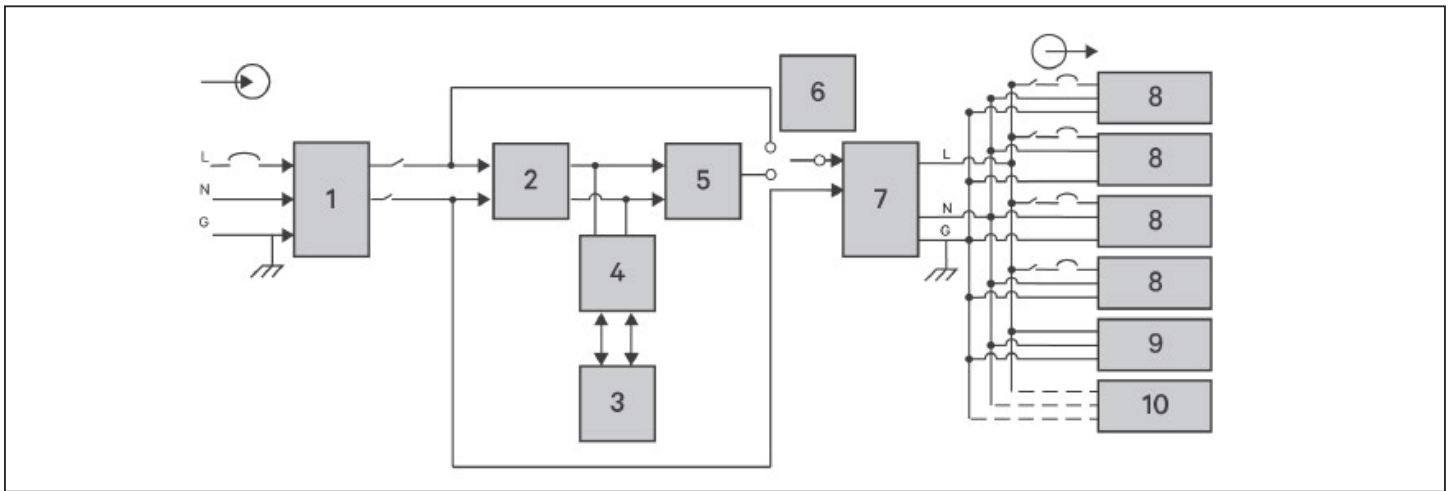
Figure 1-6 Basic Operating Principle Diagram

Table 1-2 Major Components

ITEM	COMPONENT	OPERATION/FUNCTION
1	Transient Voltage Surge Suppression (TVSS) and EMI/RFI Filters	Provide surge protection. Filter electromagnetic interference (EMI) and radio frequency interference (RFI). Minimize surges or interference present in the utility power and protect devices connected on the same branch as the UPS.
2	Rectifier/Power Factor Correction (PFC) Circuit	In normal operation, converts utility AC power to regulated DC power for use by the inverter while ensuring that the wave shape of the input current used by the UPS is near ideal. Extracting this sine-wave input current ensures efficient use of utility power and reduces reflected harmonic distortion making cleaner power available to devices that are not protected by the UPS.
3	Batteries	Valve-regulated, non-spillable, lead-acid batteries. NOTE: To maintain battery design life, operate the UPS in an ambient temperature of 59 °F to 77 °F (15 °C to 25 °C).
4	DC-to-DC Converter	Raises the DC voltage from the battery to the optimum operating voltage for the inverter. This allows the inverter to operate continuously at its optimum efficiency and voltage, thus increasing reliability.
5	Inverter	In normal operation, inverts the DC output of the PFC circuit into precise, regulated sine-wave AC power. When utility power fails, the inverter receives DC power from the DC-to-DC converter. In either operating mode, the UPS inverter remains on-line, generating clean, precise, regulated AC-output power.
6	Dynamic Internal Bypass	In the unlikely event of UPS failure such as overload or over-temperature, automatically transfers the connected load to bypass. To manually transfer the connected load from inverter to bypass, see Transferring from Normal to Bypass Mode on page 22 .
7	EMI/RFI Filters	Filter electromagnetic interference (EMI) and radio frequency interference (RFI). Minimize interference present in the utility power and protect devices connected on the same branch as the UPS.
8	Outlet group	Programmable output receptacles.
9	Outlet group	General output receptacles.
10	Outlet group	General output receptacles on 2,000- and 3,000-VA models only.

1.6. UPS States and Operating Modes

NOTE: See [LED Indicators](#) on [page 27](#), for description of the run-indicator and alarm-indicator LEDs mentioned in this section.

1.6.1. Normal Mode

When utility power is normal, Normal mode employs the rectifier and inverter to provide voltage- and frequency-stabilized power to the load. The charger charges the battery in normal mode. On the front-panel display, the run-indicator (green) is ON, the alarm indicator is OFF, and the buzzer is silent.

1.6.2. Bypass Mode

Bypass mode supplies power to the load from the bypass source (utility power) if an overload or fault occurs during normal operation. On the front-panel display, the run indicator (green) is ON, the alarm indicator (yellow) is ON, and the buzzer beeps once each seconds. The LCD “Current” screen displays “On Bypass.”

NOTE: If utility power fails or if the utility voltage goes outside of the permissible range during bypass-mode operation, the UPS shuts down and no output is supplied to the load.

1.6.3. Battery Mode

Battery mode supplies battery power to the load if utility power fails or if the utility voltage goes outside of the permissible range. On the front-panel display, the run indicator (green) is ON, the alarm indicator (yellow) is ON, and the buzzer beeps once each second. The LCD “Flow” screen displays “On Battery.”

NOTE: The batteries are fully-charged before shipment. However, transportation and storage inevitably cause some loss of capacity. To ensure adequate back-up time, it is recommended to charge the batteries for at least 8 hours before first start-up.

NOTE: If utility power fails and the batteries are charged, you may cold-start the UPS in battery mode and use battery power to extend system availability for a time.

NOTE: Powering-off the UPS when it is in battery mode results in loss of output power to the connected load.

1.6.4. Frequency Converter Mode

All models of the GXT5 are capable of frequency conversion. Frequency Conversion Mode can be selected using the configuration program. Allowable frequency operating modes include:

- Auto Sensing - 50 Hz or 60 Hz – Bypass Enabled
- Auto Sensing - 50 Hz or 60 Hz – Bypass Disabled
- Frequency Converter - 50 Hz – Bypass Disabled
- Frequency Converter - 60Hz – Bypass Disabled

NOTE: The default for all models of the Liebert® GXT5 is “Auto Sensing - 50 Hz or 60 Hz – Bypass Enabled.”

1.6.5. ECO Mode

The energy-saving ECO mode reduces power consumption by powering the load via bypass if the bypass voltage is normal or by powering the load via the inverter when the bypass voltage is abnormal. You can use ECO mode to power equipment that is not sensitive to power-grid quality to via bypass and reduce power consumption.

NOTE: During ECO mode, if a bypass-failure or abnormal-bypass-voltage notification appears when the output is not overloaded, the UPS will transfer to Normal Mode. However, if a notification showing bypass failure or abnormal bypass voltage appears when the output is overloaded, the UPS will shut down the bypass and therefore the load will shut down.

Chapter 2: Installation

Do not start the UPS until after the installation is finished.



WARNING! Risk of electric shock

Can cause equipment damage, injury and death. Before beginning installation, verify that all external overcurrent protection devices are open (Off), and that they are locked-out and tagged appropriately to prevent activation during the installation, verify with a voltmeter that power is Off and wear appropriate, OSHA-approved personal protective equipment (PPE) per NFPA 70E. Failure to comply can cause serious injury or death. Before proceeding with installation, read all instructions. Follow all local codes.

2.1. Unpacking and Inspection

Unpack the UPS and conduct the following checks:

- Inspect the UPS for shipping damage. If any shipping damage is found, report it to the carrier and your local Vertiv representative immediately.
- Check the accessories included against the packing list. If there is any discrepancy, contact your local Vertiv representative immediately.



CAUTION

The UPS is heavy (see [Specifications](#) on [page 67](#), for the weight). Take proper precautions when lifting or moving the unit.

2.2. Pre-installation Preparation

- Install the UPS indoors in a controlled environment, where it cannot be accidentally turned Off. The installation environment should meet the specifications listed in [Specifications](#) on [page 67](#).
- Place the UPS in an area of unrestricted air-flow around the unit, away from water, flammable liquids, gases, corrosives, and conductive contaminants. Avoid direct sunlight.

NOTE: Operating the UPS in temperatures above 77°F (25°C) reduces battery life.

2.2.1. Installation Clearances

Maintain at least 4 in. (100 mm) clearance in the front and rear of the UPS. Do not obstruct the air inlets on the front panel and rear panel of the UPS. Blocking the air inlets reduces ventilation and heat dissipation, shortening the service life of the unit.

2.3. Installing the UPS

The UPS may be installed as a tower or in a rack, depending on available space and use considerations. Determine the type of installation and follow the appropriate instructions. See [Tower Installation](#) or [Rack Installation](#) on next page.

NOTE: When installing the UPS or making input and output connections, comply with all relevant safety codes and standards.

2.3.1. Tower Installation

To install the UPS as a tower:

1. Take the support bases out of the accessories box.

Figure 2-1 Support bases

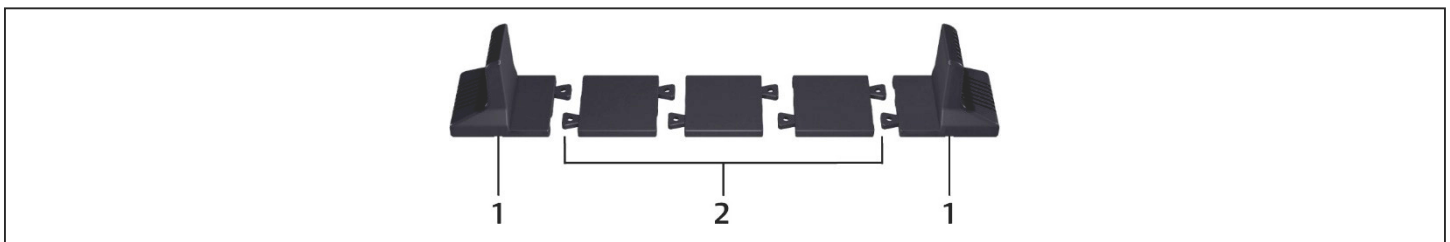

NO.	DESCRIPTION
1	Support bases
2	Spacers with connectors NOTE: Three spacers are shown here. However, the number of spacers varies depending on your UPS model and the number of battery cabinets in your system.

2. If optional, Liebert® external battery cabinets will be connected, take out the spacers shipped with the battery cabinet.
3. Connect the spacers and the support bases as shown in [Figure 2-1](#) above. Each GXT5 requires 2 support bases, one in the front and one in the rear.
4. Place the GXT5 and any battery cabinets on the 2 support bases.

2.3.2. Rack Installation

When installed in a rack enclosure, the GXT5 UPS and external battery cabinets (EBC) must be supported by a shelf or rack-mount rails. Because different rack-mount options install differently, refer to the installation instructions provided with the rack-mount kit.



CAUTION

The GXT5 is heavy. The UPS must be installed as near the bottom of a rack as possible. If placed too high, it can make the rack top-heavy and prone to tipping over. For unit weights, see [Specifications](#) on [page 67](#).

2.4. Installing External Battery Cabinets

Optional, external battery cabinets (EBC) may be connected in parallel to the UPS to provide additional battery run time. For approximate battery run times with additional EBCs, see [Battery Run Times](#) on [page 70](#). External battery cabinets are placed on one side of the UPS in a tower configuration or stacked beneath the UPS in a rack configuration. Up to 10 EBCs may be connected to the UPS, and up to 6 may be detected using EBC-detection.



WARNING! Risk of electric shock

Can cause injury or death. Disconnect all local and remote electric power supplies before working with the UPS. Ensure that the unit is shut down and power has been disconnected before beginning any maintenance.



CAUTION

The external battery cabinet(s) are heavy, see [Table 7-4](#) on [page 69](#). Take proper precautions when lifting them.

To install the EBC(s):

1. Inspect the EBC for freight damage. Report damage to the carrier and your local dealer or Vertiv representative.
2. For tower installation:
 - An additional set of support-base extensions ships with each EBC.
 - See the steps in [Tower Installation](#), to connect the support extenders and install the bases.
- or -
3. For rack installation:
 - Rack-mount hardware ships with the EBC.
 - Refer to the instructions included with the rack-mount kit to install.

NOTE: Optional slide rails and securing hardware are sold separately. Please contact your Vertiv representative for options and Vertiv Technical Support for assistance.

4. Verify that the EBC breaker is in the “Off” position.

5. Connect the supplied EBC cable(s) to the rear of the cabinet, then to the rear of the UPS, see [Figure 2-2](#).
6. Turn the EBC breaker to the “On” position.
7. Verify the circuit breaker on the EBC is in the “On” position.
The additional back-up run time is enabled.

NOTE: If installing more than 6 EBCs, the user must adjust the number of EBCs manually in Settings > Battery > External battery cabinet group No.

NOTE: When removing an EBC, turn off the circuit breaker on the rear of the cabinet before disconnecting the cable.

NOTE: If shipping or storing the UPS for an extended time, disconnect the EBC(s) minimize stand-by current drain on the batteries and help maintain design life.

Figure 2-2 EBCs connected to the UPS

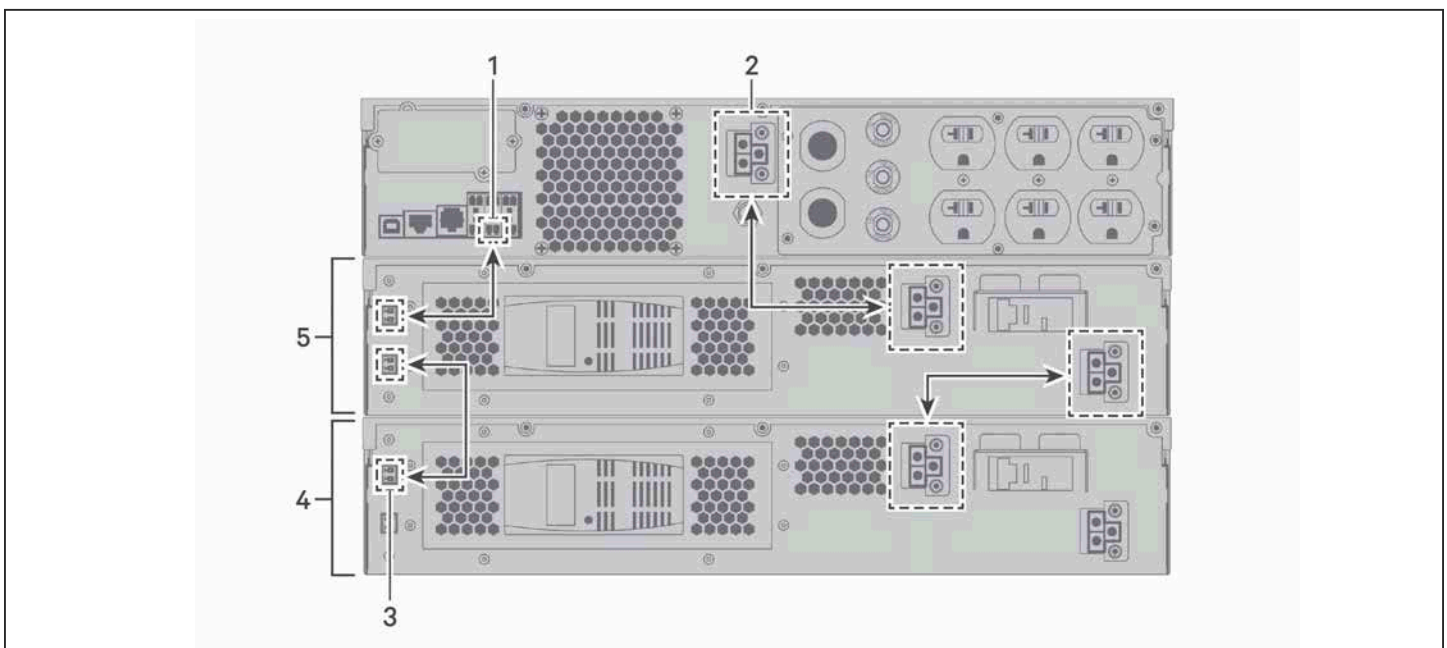

ITEM	DESCRIPTION
1	EBC-detection port (See Table 2-2 on page 17 , for details.)
2	EBC connector
3	EBC-detection port
4	External battery cabinet
5	External battery cabinet

2.5. Connecting AC Input Power

Ensure that all the loads are turned Off. Prepare an input power supply that is properly protected by a circuit breaker in accordance with national and local electrical codes. The wall receptacle must be grounded. We recommend installing an upstream circuit breaker of the same series as the input circuit breaker of the GXT5.

Table 2-1 below, lists the specifications of the input circuit breaker on the rear panel by UPS model.

Table 2-1 Input circuit breaker specifications

MODEL	RATED CIRCUIT BREAKER
GXT5-500LVRT2UXL	12 A
GXT5-750LVRT2UXL	12 A
GXT5-1000LVRT2UXL (TAA)	12 A
GXT5-1500LVRT2UXL (TAA)	15 A
GXT5-2000LVRT2UXL (TAA)	20 A
GXT5-3000LVRT2UXL (TAA)	30 A

To connect AC-input power, plug the input plug of the UPS into the input-power connection.

NOTE: If the input plug will serve as the disconnecting device, the wall socket/outlet must be near the UPS and must be easily accessible, per the National Electric Code/NFPA 70 requirements.

A. Connecting Loads

500-VA to 1500-VA models have six outlets:

- Two are not programmable (always On).
- Four are controlled with programmed responses or an SNMP network.

2000-VA and 3000-VA models have seven outlets:

- Three are not programmable (always On).
- Two groups are controlled with programmed responses or an SNMP network.

NOTE: When connecting load, verify that the equipment is plugged into the appropriate outlets if any of the outlets will be controlled. Do not overload any output receptacle. Output cable length should not exceed 10 m (32.8 ft).

To connect equipment, plug equipment into the appropriate output receptacles on the rear of the UPS, see the appropriate figure for your model in [Rear Panels](#) on [page 4](#).

2.6. Communication Connections

The UPS offers several communication interfaces and ports.

NOTE: We recommend that signal-cable lengths be less than 10 ft (3 m), and are kept away from power cabling.

2.6.1. Connecting IntelliSlot Communication

The Liebert® IntelliSlot™ RDU101 provides SNMP monitoring of the UPS across the network and/or building management system.

See the appropriate figure for your model in [Rear Panels](#) on [page 4](#), for the location of the card port.

To install an IntelliSlot Card:

1. Remove the screws from the slot cover plate and remove the plate.
2. Insert the card into the slot, and secure with the screws that held the cover plate.

To make connections to the card, refer to the Installer/User Guide for the appropriate IntelliSlot card available at www.vertiv.com.

2.6.2. Connecting to the Dry-contact Port

The UPS includes a dry-contact port. See the appropriate figure for your model in [Rear Panels](#) on [page 4](#), for the location of the port. [Figure 2-3](#) below, shows the ports and [Table 2-2](#) on the next page, describes each port.

The I/O dry contact port capacity is 125 Vac, 0.5 A; 30 Vdc, 1 A.

Figure 2-3 Dry-contact Port and Pin Layout

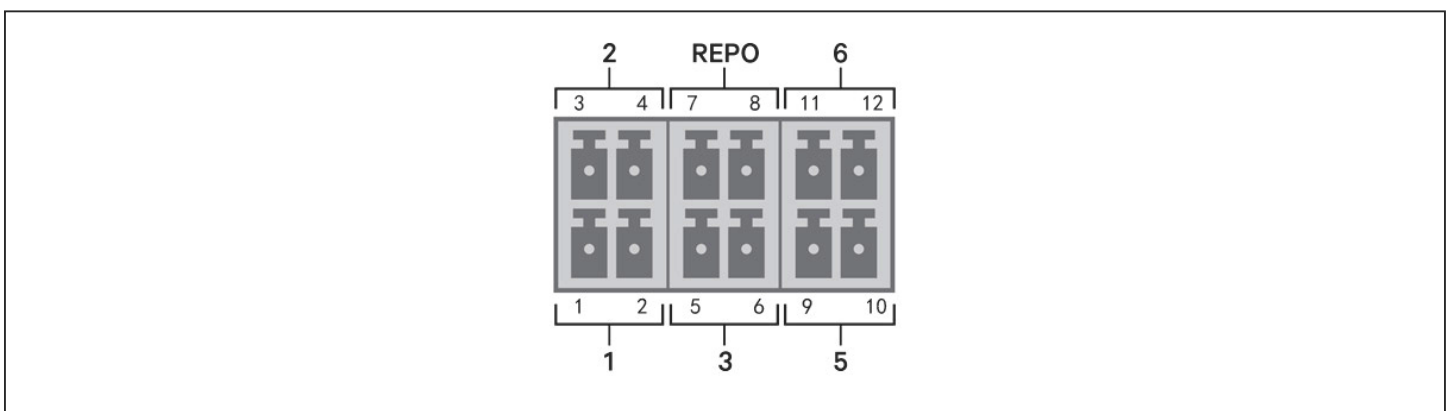

NOTE: Pins 7 and 8 are shorted before delivery.

NOTE: The emergency power-off (EPO) action of the UPS closes the rectifier, inverter and static bypass, but it cannot disconnect the UPS mains input inside. To completely disconnect the UPS, disconnect the upstream input circuit breaker when generating the EPO. For details on REPO connection and operation, see [Connecting a Remote Emergency Power-off \(REPO\) Switch](#) on the next page.

Table 2-2 Dry-contact Connection and Pin-out Descriptions

PORT NO.	PORT NAME	PIN NO.	PIN NAME	DESCRIPTION
1	Input 1	1	Remote Comms Shutdown 1	User configurable dry-contact input that can be set to trigger the events below. The user can also select the dry-contact as either NO or NC. (See System Parameter Options on page 37) When NO, Pins 1 and 2 are shorted to trigger the event. When NC, Pins 1 and 2 are opened to trigger the event. Options are: <ul style="list-style-type: none"> • Disable (default) • Battery mode shutdown - If the UPS is running on batteries and this input is triggered, the UPS shuts down • Any mode shutdown - If this input is triggered, the UPS shuts down regardless of current operating mode
		2	Signal Ground	Signal Ground
2	Input 2	3	Remote Comms Shutdown 2	User configurable dry-contact input that can be set to trigger the events below. The user can also select the dry-contact as either NO or NC. (See System Parameter Options on page 37) When NO, Pins 3 and 4 are shorted to trigger the event. When NC, Pins 3 and 4 are opened to trigger the event. Options are: <ul style="list-style-type: none"> • Disable (default) • Battery mode shutdown - If the UPS is running on batteries and this input is triggered, the UPS shuts down • Any mode shutdown - If this input is triggered, the UPS shuts down regardless of current operating mode
		4	Signal Ground	Signal Ground
3	Battery Detection	5	EBC Detection	Automatically detects number of external- battery cabinets when pins 5 and 6 are connected to the detection port, see Installing External Battery Cabinets on page 13.
		6	EBC Detection	Automatically detects number of external- battery cabinets when pins 5 and 6 are connected to the detection port, see Installing External Battery Cabinets on page 13.
REPO	REPO Input	7	+5V	REPO power supply, 5-Vdc 100-mA
		8	REPO Coil -NC	NC, activated when Pin 7 and Pin 8 is open NOTE: For details on REPO connection and operation, see Connecting a Remote Emergency Power-off (REPO) Switch.
5	Output 5	9,10	Remote Fault Alert 5	User configurable dry-contact output that can be set to alert the user to the faults below. The user can also select the dry-contact as either NO or NC. (See System Parameter Options on page 37) When NO, Pins 9 and 10 are shorted when the fault occurs. When NC, Pins 9 and 10 are opened when the fault occurs. Options are: <ul style="list-style-type: none"> • Low battery (default) • On battery • On bypass • UPS fault
6	Output 6	11,12	Remote Fault Alert 6	User configurable dry-contact output that can be set to alert the user to the faults below. The user can also select the dry-contact as either NO or NC. (See System Parameter Options on page 37) When NO, Pins 11 and 12 are shorted when the fault occurs. When NC, Pins 11 and 12 are opened when the fault occurs. Options are: <ul style="list-style-type: none"> • Low battery • On battery • On bypass • UPS fault (default)

2.6.3. Connecting a Remote Emergency Power-off (REPO) Switch

The UPS includes an EPO connection in the dry-contact port. See the appropriate figure for your model in [Rear Panels](#) on [page 4](#), for the location of the port.

UPS ships with a REPO jumper installed, allowing the UPS to operate as a normally-closed switch system (fail-safe). Opening the circuit disables the UPS. To connect a REPO switch that opens the circuit to shut down the rectifier and inverter and power-off the UPS, use a cable from the remote switch to plug into the REPO-port on the UPS.

In normal conditions, the REPO switch cannot cut off the UPS input power. When the REPO switch trips, the UPS generates an alarm and immediately cuts-off output power. When the emergency condition is resolved, the UPS will not return to normal operation until you reset the REPO switch and manually power-on the UPS.

To make the cable for the REPO connection:

[Figure 2-4](#) below, shows the cable required to make the connection. We recommend using 18 AWG to 22 AWG (0.82 mm² to 0.33 mm²) copper-core cable.

1. Remove the insulation from the end of two cables.
2. Insert the stripped end into the plug terminals 1 and 2 respectively, then press down the terminals. Make sure that the cables are secure in the plug to prevent failure because of loose contact.

To connect a UPS to the REPO switch.



CAUTION

To maintain safety (SELV) barriers and electromagnetic compatibility, signal cables should be shielded and run separately from power cables.

1. Connect one end of the cable to the remote switch, see [Figure 2-4](#) below.
2. Remove the factory-installed jumper from pins 7 and 8 of the dry-contact port on the UPS.
3. Connect the plug to pins 7 and 8.

Figure 2-4 Cable/Plug for Connecting REPO switch to UPS REPO port

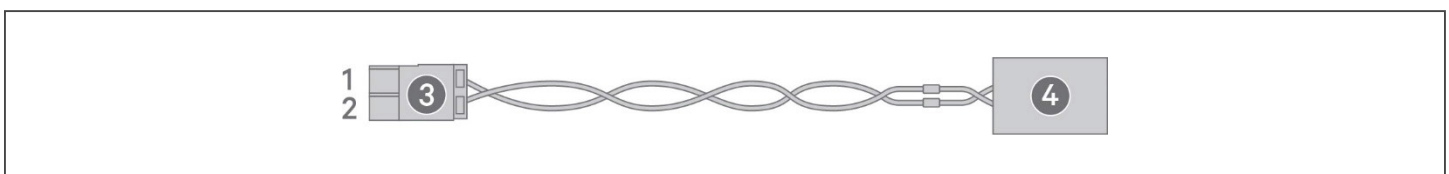

ITEM	DESCRIPTION
1	Terminal 1
2	Terminal 2
3	Plug (connects to REPO port on UPS)
4	REPO switch

2.6.4. Connecting a USB Cable

The UPS includes a USB connector. See the appropriate figure for your model in [Rear Panels](#) on [page 4](#), for the location of the port.

The standard, B-type USB port connects the UPS to a network server or other computer system. The USB port supports HID/CDC protocol. The CDC protocol is reserved for service software. To use the HID protocol for monitoring, get Power Assist from www.vertiv.com.

2.6.5. Connecting CLI Communication Cables

The UPS supports the Vertiv command-line interface for operation with Vertiv ACS and other third-party monitoring protocols. The RJ-45 port (labeled “R232”) is used for CLI connection. See the appropriate figure for your model in [Rear Panels](#) on [page 4](#), for the location of the port. The pin-out, described in below table is consistent with the ACS pin-out.

ITEM	DESCRIPTION
1	NC
2	NC
3	TXD (out)
4	GND
5	NC
6	RXD (in)
7	NC
8	NC

This page is intentionally left blank.

Chapter 3: Operating the UPS



WARNING! Risk of electric shock

Can cause injury or death. Hazardous mains and/or battery voltage exists behind the protective cover. No user accessible parts are located behind the protective covers that require a tool for removal. Only qualified service personnel are authorized to remove such covers. If maintenance for rack is needed, notice that the neutral line is live.

3.1. Silencing the Audible Alarm

The audible alarm may sound during UPS operation. To silence the alarm, press and hold the ESC button for 2 seconds. The button is located on the front-panel display, see [Operation and Display Panel](#) on [page 25](#).

3.2. Starting-up the UPS

IMPORTANT! Do not start the UPS until after the installation is finished, the system is commissioned by an authorized engineer, and the external input circuit breakers are closed.



CAUTION

Starting the UPS applies mains/utility power to the output terminals. Make sure that the load power is safe and ready to accept power. If the load is not ready, isolate the load with the output terminal.

The UPS starts in Normal Mode.

To start the UPS:

1. If included on your UPS model, make sure the maintenance-bypass switch is in the open “OFF” position and that the guard is secured in place.
2. Ensure that the REPO connector on the rear of the unit has a jumper between pins 7-8 or that it is properly wired to an Emergency Power- Off circuit (normally closed).
3. Make sure the breaker supplying power to the UPS is closed, and if necessary press the input circuit breaker reset buttons at the rear of the UPS.
4. If included on your UPS model, close the bypass breaker on the rear of the UPS.
5. Close all output breakers on the rear of the UPS (or in an external panel board, if used).
6. Power-on the UPS by pressing and holding the power button on the operation and display panel until the confirmation dialog appears. Use the Up/ Down arrows to select YES, then press **Enter**.
7. If this is the first-time start-up of the UPS, the Start-up Guidance wizard opens to set the basic parameters of the UPS. Follow the prompts.

For detailed description of UPS display functions and settings, see [Operation and Display Panel](#) on [page 25](#).

3.3. Transferring to Battery Mode

The UPS operates in Normal mode unless the mains/utility power fails or it is performing a battery self test, then it automatically transfers to Battery mode for the back-up time available or the mains/utility power is restored. Once input power is restored, the UPS returns to Normal mode.

NOTE: Battery back-up run times are listed in [Battery Run Times](#) on [page 70](#).

3.4. Transferring from Normal to Bypass Mode

Press and hold the power button for 2 seconds.

If the UPS is operating normally, without faults, the option to continue to turn-on or turn-off the UPS displays:

- a. Use the arrow buttons to select *To the Bypass*, and press **Enter**.
- b. Use the arrow buttons to select *No* or *Yes*, then press **Enter** to confirm.

If the bypass power is outside normal operating range, do not transfer to Bypass mode.

3.5. Transferring from Bypass to Normal Mode

Press and hold the power button for 2 seconds.

If the UPS is operating normally, without faults, the option to continue to turn-on or turn-off the UPS displays:

- a. Use the arrow buttons to select *Turn on UPS*, and press **Enter**.
- b. Use the arrow buttons to select *No* or *Yes*, then press **Enter** to confirm.

NOTE: The UPS automatically switches back to normal mode after an “overheated” or “overloaded” fault is cleared and normal power is restored.

3.6. Shutting-down the UPS Completely



WARNING! Risk of electric shock

Can cause injury or death. Disconnect all local and remote electric power supplies before working with the UPS. Ensure that the unit is shut down and power has been disconnected before beginning any maintenance.

Transfer to Bypass mode, see [Transferring from Normal to Bypass Mode](#) above. Then, if power to the load is not needed, open the main-input circuit breaker.

3.7. Remote Emergency Power-off (REPO)

REPO turns off the UPS in emergency conditions such as fire or flood. When an emergency occurs, the REPO switch turns off the rectifier and inverter and stops powering the load immediately. The battery stops charging and discharging.

To manually power-off in an emergency, disconnect the terminal connecting the REPO port on the rear of the UPS.

If mains/utility power is present, the UPS control circuit remains active even though output power is disabled. To remove all mains/utility power, disconnect the external main-input circuit breaker.

This page is intentionally left blank.

Chapter 4: Operation and Display Panel

NOTE: The UPS has a gravity-sensor function that automatically rotates the LCD display depending on tower or rack installation. See [Display orientation](#) on [page 36](#).



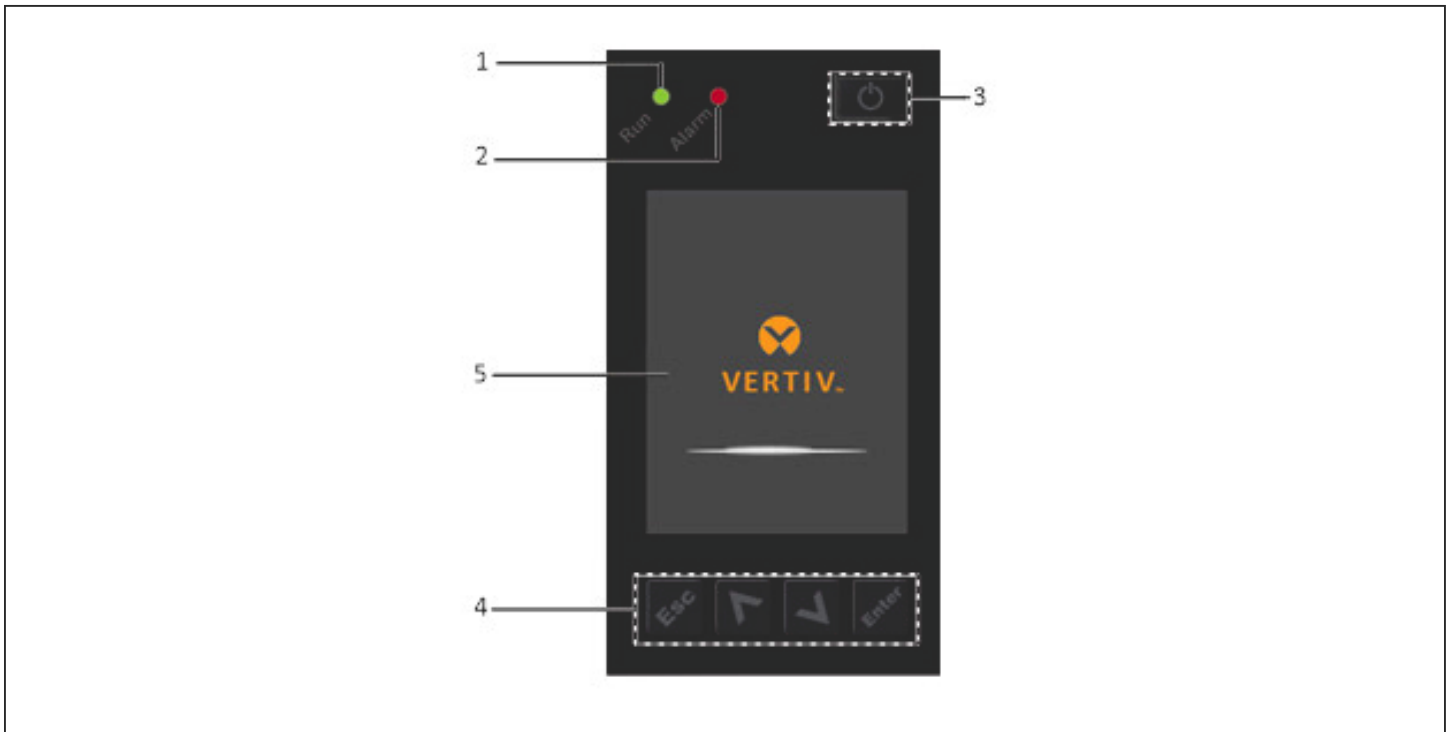

The operation/display panel includes LED indicators, function keys, and an LCD interface to configure and control UPS operation.

Figure 4-1 UPS Front-panel Display



ITEM	DESCRIPTION
1	Run indicator LED, see LED Indicators on page 27 .
2	Alarm indicator LED, see LED Indicators on page 27 .
3	Power button, see Table 4-1 on the next page.
4	Menu keys, see Table 4-1 on the next page.
5	LCD panel.

Table 4-1 Display-panel Button Functions and Descriptions

BUTTON	FUNCTION	DESCRIPTION
	Enter	Confirm or enter selection.
	Up	Move to previous page, increase value, move left.
	Down	Move to next page, decrease value, move right.
	Escape	Go back.
	Power	Power-on the UPS, power-off the UPS, transfer to Bypass Mode.

NOTE: While the UPS is operating, the LCD will dim and display a screen saver if there is no active alarm or user interaction for two minutes, see [Figure 4-2](#). After 4 minutes of inactivity, the display will blank to conserve power. If an alarm or fault occurs or if any button is pressed, the UPS-flow screen displays.

Figure 4-2 LCD Screen Saver

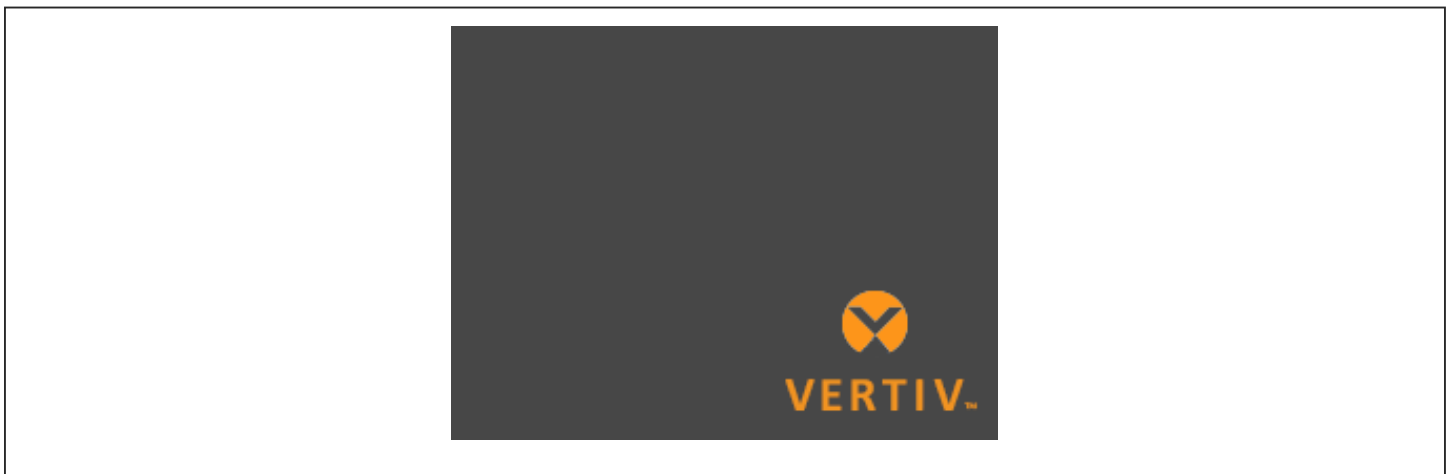

4.1. LED Indicators

The LEDs on the front-panel display indicate operation and alarm statuses of the UPS.

NOTE: When an alarm is indicated, an alarm message is logged on [page 42](#), describes the alarm messages you may see. When a fault is indicated, front-panel display list the fault, which are described in [Table 6-2](#) on [page 64](#).

Table 4-2 LED Functions

INDICATOR	LED COLOR	LED STATE	INDICATES
Run indicator	Green	On	UPS has output
		Blinking	Inverter is starting
		Off	UPS has no output
Alarm indicator	Yellow	On	Alarm occurs
	Red	On	Fault occurs
	None	Off	No alarm, no fault

4.2. LCD Menu and Screens

The menu-driven LCD user interface lets you browse the UPS status, view operating parameters, customize settings, control operation, and view alarm/event history. Use the function keys to navigate through the menu, and view statuses or select settings in the screens.

4.2.1. Start-up and Flow Screens

At start-up, the UPS executes a system test and displays the Vertiv logo screen for about 10 seconds, shown in [Figure 4-1](#) on [page 25](#). After the test completes, an overview screen shows status information, the active (green) power path, and the non-working power path (gray).

NOTE: [Figure 4-3](#) is an example flow screen and does not reflect the actual values that you may see on your unit.

Figure 4-3 UPS Flow Screen

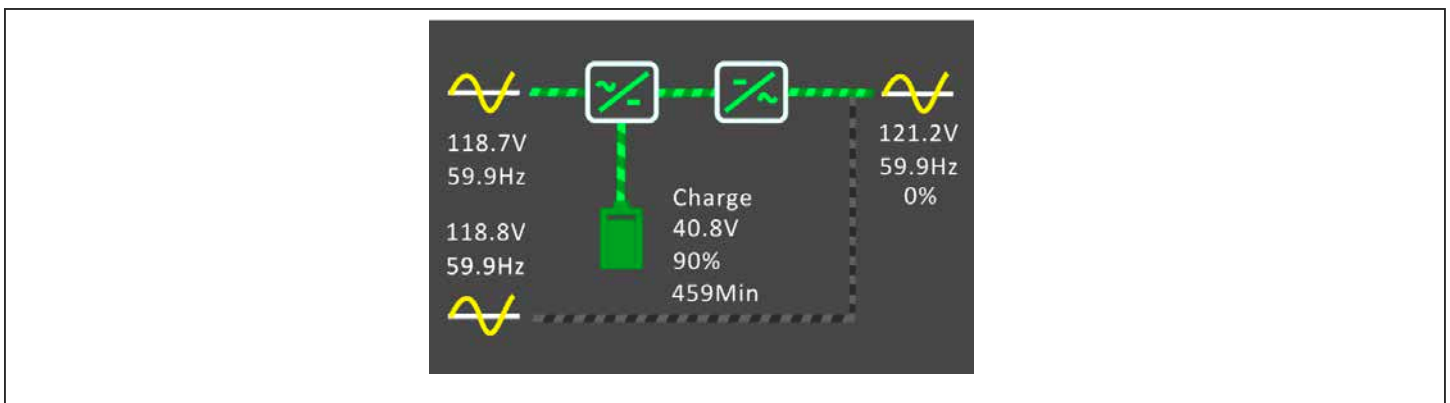

4.2.2. Main Menu

To access the main menu, press **Enter** while at the flow screen. [Table 4-3](#) below, describes the menu options, and [Figure 4-4](#) below, describes the display.

Use the arrow buttons to select the sub-menu options, and press **Enter** to open the sub menu. Press ESC to return to the flow screen.

Table 4-3 Menu Options

SUB MENU	DESCRIPTION
Status	Voltage, current, frequency, and parameters for UPS components, see Status Screen on the facing page.
Settings	Display and system parameter settings, see Settings Submenu on page 32 .
Control	UPS controls, see Control Screen on page 41 .
Log	Current alarms and event history, see Log Screen on page 42 .
About	Product and network information, see About Screen on page 45 .
Maintenance	Service-only, service-password protected page for use only by Vertiv service representatives.

Figure 4-4 Main Menu

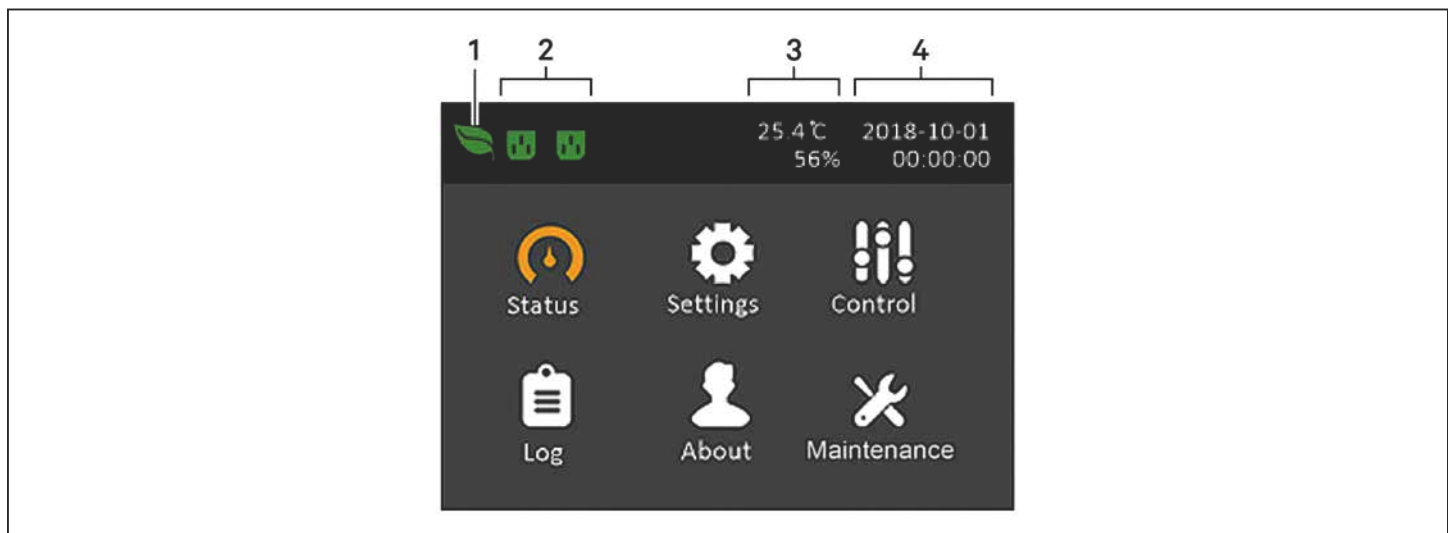

ITEM	DESCRIPTION
1	ECO-mode indicator
2	Programmable-outlet indicator
3	Ambient temperature and humidity. Only displays when sensors are connected.
4	Date and time

4.2.3. Status Screen

The status screen displays voltages, currents, frequencies, and parameters on individual tabs for input, bypass, battery, output, and load status.

To view the UPS status information:

1. At the main menu, select the Status icon, and press **Enter**.
2. Use the arrow buttons to move the cursor left/right and select a tab, then press **Enter** to display the status information for the selected tab.

Figure 4-5 Status-screen tabs

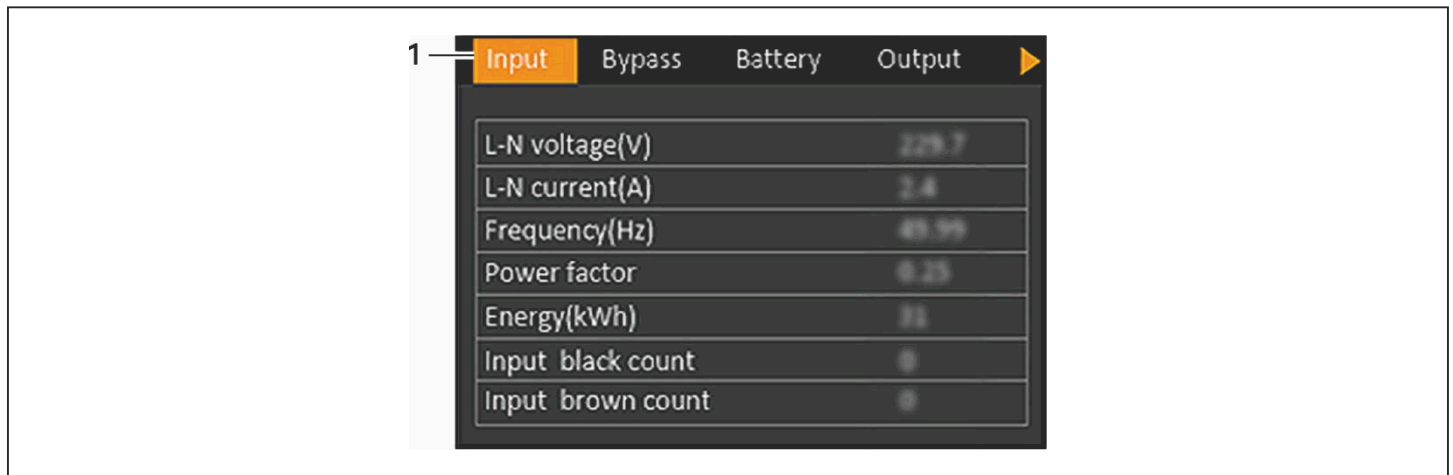

ITEM	DESCRIPTION
1	Screen tabs with Input tab selected

NOTE: Multiple phases are shown in multiple columns. For example, a unit with 3-phase input will display 3 columns of status data.

Input Status Options

L-N voltage (V)

Line-neutral voltage of input power.

L-N current (A)

Line-neutral current of input power.

Frequency (Hz)

Frequency of input of input power.

Power Factor

Power factor of the input power.

Energy (kWh)

Input power.

Input black count

The number times that the input voltage was lost or dropped below 60 VAC (black out). Resets to 0 when UPS is powered down.

Input brown count

The number of times that the input voltage was too low to support the load and the UPS was forced to switch to battery power (brown out). Resets to 0 when the UPS is powered down.

Bypass Status Options**L-N voltage (V)**

Line-neutral voltage of bypass power.

Frequency (Hz)

Frequency of bypass power.

Battery Status Options**Battery status**

Current battery state: charging, discharging, or fully-charged.

Battery voltage (V)

Voltage of battery power.

Battery current (A)

Current of battery power.

Backup time (Min)

Amount of back-up time remaining for battery.

Remaining capacity (%)

Percent of capacity remaining for battery.

Discharge count

Number of discharges for the battery module.

Total discharge time (Min)

Number of minutes until battery is fully discharged.

Battery running time (Day)

Number of days the batteries have been in operation.

Battery replacement time

Date of last time battery was replaced.

External battery cabinet group No.

Number of external battery cabinets connected.

Battery average temp (°C)

Average temperature of the battery.

Battery highest temp (°C)

Highest temperature battery has reached.

Battery lowest temp (°C)

Lowest temperature battery has reached.

Output Status Options**L-N voltage (V)**

Line-neutral voltage of output power.

L-N Current (A)

Line-neutral current of output power.

Frequency (Hz)

Frequency of output power.

Energy (kWh)

Output power.

Load Status Options**Sout (kVA)**

Apparent output power.

Pout (kW)

Active output power.

Power Factor

Power factor of output power.

Load percent (%)

Percentage of recent power rated to output power.

4.2.4. Settings Submenu

The settings screen consists of tabs that list UPS settings for configuration and adjusting parameters with tabs for:

- Output
- Battery
- Monitor
- System
- Outlets

NOTE: Do not change parameter settings or reset to factory defaults when powering-off the UPS.

To modify UPS settings:

1. At the main menu, select the Settings icon, and press **Enter**.

NOTE: To adjust the settings, you must enter a password. See [Editing Display and Operation Settings on page 47](#), for details on entering the password and editing the setting parameters.

2. Use the arrow buttons to move the cursor left/right and select a tab, then press **Enter** to display the parameter list for the selected tab.
3. Use the arrow buttons to scroll through the parameter list, and press **Enter** to select a parameter.
4. Use the arrow buttons to select the parameter value, press **Enter** to save the selection or press **Esc** to discard the change.

Output Parameter Options

Voltage selection

Nominal voltage setting. Set the nominal system voltage to match the input voltage of the UPS.

- 100 V
- 110 V
- 115 V
- 120 V (default)
- 125 V
- Autodetect

Startup on bypass

Allows the UPS to start-up in bypass mode.

- Enable = Start the UPS in bypass mode
- Disable = Start the UPS in normal mode (default)

Frequency selection

Selects the frequency of the output. Options are:

- Auto, Bypass enabled = Automatically detects frequency of utility/mains power and sets the nominal frequency to match and bypass mode is enabled (default).
- Auto, Bypass disabled = Automatically detects frequency of utility/mains power and sets the nominal frequency to match and bypass mode is disabled.
- Frequency converter 50 Hz = Bypass mode is disabled and the UPS provides 50-Hz output from any qualified utility/mains power.
- Frequency converter 60 Hz = Bypass mode is disabled and the UPS provides 60-Hz output from any qualified utility/mains power.

Bypass voltage upper limit

Sets the percentage that the input voltage may be above the selected output voltage setting and remain in Bypass mode.

- +10% (default)
- +15%
- +20%

Bypass voltage lower limit

Sets the percentage that the input voltage may be below the selected output voltage setting and remain in Bypass mode.

- -10%
- -15% (default)
- -20%

Run mode

Selects Normal or ECO operation for the UPS. Options are:

- Normal = Connected load is always powered through the UPS inverter. ECO mode is disabled.
- ECO mode = ECO mode is enabled. The UPS inverter is bypassed, and the connected load is powered by utility/mains power within the selected ECO voltage and frequency tolerances.

ECO voltage range

(Option only available when Run mode is set to ECO.) Sets the percentage that the input voltage may be above or below the selected output voltage setting and remain in ECO mode.

- $\pm 5\%$
- $\pm 10\%$ (default)
- $\pm 15\%$

ECO frequency range

(Option only available when Run mode is set to ECO.) Sets the amount that the input frequency (Hz) may be above or below the selected frequency setting and remain in ECO mode.

- $\pm 1\text{Hz}$
- $\pm 2\text{Hz}$
- $\pm 3\text{Hz}$ (default)

ECO requalification time

(Option only available when Run mode is set to ECO.) To ensure the stability of the utility/mains power, this is the length of time that the UPS requires the input voltage and frequency tolerances to be maintained before switching to ECO-mode.

- 1min (default)
- 5 min
- 15 min
- 30 min

Battery Parameter Options

External battery AH

Sets the amp-hour rating of the external battery.

NOTE: Only adjust when using third-party external batteries with External battery cabinet group No. set to 0. The rating is calculated automatically when using Vertiv EBCs with a non-zero setting for External battery cabinet group No.

- 0 - 300 Ah (default of 0)

External battery cabinet group No

Sets the number of attached external battery cabinets or allows the UPS to detect the number of EBCs automatically with Autotest.

NOTE: Autotest is used for up to 6 Vertiv EBCs. If more than 6 Vertiv EBCs are connected, the number of cabinets must be set manually. For third-party external batteries, set this option to 0 and use External battery AH setting above.

- 0 - 10
- Autotest (default)

Low battery time

Sounds an alarm when the selected amount of time remaining for the UPS to operate in Battery mode.

- 2 - 30 minutes (default of 2)

Battery periodic test enable

The UPS can periodically self-test the battery.

- Enable
- Disable (default)

Battery periodic test interval

Sets the length of time between periodic test.

- 8, 12, 16, 20, or 26 weeks (default is 8)

Battery periodic test weekday

Sets the day of the week that the battery periodic test is performed.

- Sunday - Saturday (Wednesday is default)

Battery periodic test time

Sets the time that the battery periodic test is performed.

- 00:00 - 23:59 (default is 00:00)

Batt. note duration (month)

Sets the length of time after the batteries are replaced to generate an alarm to remind the user to replace the batteries.

- Disable (default)
- 1 - 72 months

Dischg protect time

Sets the maximum discharge time for the UPS. The default setting is the maximum allowing the battery to fully discharge. Setting the value lower limits the amount of time the UPS will provide battery protection after which it will shut down. If the discharge time remaining on the battery is lower than the setting value, it will have no effect.

- 1 - 4320 minutes (default of 4320)

Equal charge enable

Sets the charge mode of the battery. Equal charge mode is a quick charge mode that can reduce the amount of time needed to charge the battery. Float charge mode can have a longer battery life.

- Enable = Equal charge mode
- Disable = Float charge mode (default)

Max chg curr

Sets the maximum charge current for the battery. A higher charge current will charge the battery more quickly but can shorten battery life. A lower value will lengthens the battery charge time and can increase battery life. The load is always prioritized and the charge current will be decreased internally if necessary to support the load.

- 0.9 - 13 A (default of 2.2)

NOTE The maximum setting of this value always shows as 13A on the display however it varies based on internal battery size and the number of EBCs connected. If the value does not save after it is selected, it is too high for the model.

Temp compensation

When enabled, the UPS will adjust the charging voltage of the batteries based on temperature in order to preserve battery life. It will increase the voltage if the UPS is operating in a cold environment. It will decrease the voltage if the UPS is operating in a warm environment.

- Enable
- Disable (default)

Replace battery

Activates newly-installed battery packs after replacement and reset all battery statistics for new battery packs.

- Provides a confirmation window with Yes/No options to confirm replacement of batteries.

Monitor Settings Options

Language

Selects the language of the display, see [Selecting the Display Language](#) on [page 48](#). Options are:

- English (default)
- French
- Portuguese
- Spanish
- Chinese
- German
- Japanese
- Russian

Date

Selects the current date for the UPS display, YYYY-MM-DD. See [Setting the Date and Time](#) on [page 49](#).

Time

Select the current time for the UPS display, HH:MM:SS. See [Setting the Date and Time](#) on [page 49](#).

Display orientation

Selects the orientation of the display for use in rack or tower configuration. Options are:

- Auto-rotate = Automatically rotates based on the detected orientation of the UPS (default).
- Horizontal = Screen rotated for rack use.
- Vertical = Screen rotated for tower use.

Audible alarm

If enabled, the UPS will beep when an alarm is generated. If disabled, it will be silent. See [Audible Alarm \(Buzzer\)](#) on [page 63](#).

- Enable (default)
- Disable

Change settings password

Opens the dialog to change the password used to access and update the UPS parameter settings, see [Changing the Password](#) on [page 48](#).

System Parameter Options

Auto restart

Allows the automatic restart of the UPS when input power is restored after a complete shutdown of the UPS system.

- Enable = The UPS will restart automatically when the input power is restored after a complete shutdown. (default)
- Disable = The UPS will not restart automatically

Auto restart delay

Length of time to elapse before an automatic restart after input power is restored.

- 0 - 999 seconds (default 0)

Guaranteed shutdown

Forces a continued shutdown of the UPS once the Low Battery threshold is reached, even if input power is restored during this time. This can be used to make sure that connected equipment shuts down completely. When using the low battery relay output to gracefully shut down connected equipment, it is possible that the input power is restored after the Low battery output is triggered. In this situation, the connected equipment could power down smoothly but never lose input power, causing it not to start back up as intended. Enabling this option prevents this situation from occurring by ensuring that a shutdown of the output happens.

- Enable (default)
- Disable

Start with no battery

Allows the UPS to start when the battery has reached the end of discharge (EOD). This can be used to turn on the UPS and power the attached load without battery protection when utility power has been restored after the battery was fully depleted. It works in conjunction with the Auto restart setting above.

- Enable (with Auto restart enable) = The UPS will power the load with no user intervention when mains power returns after the battery has been fully depleted
- Enable (with Auto restart disabled) = The UPS will start up and allow the user to turn on the output when power returns after the battery has been fully depleted
- Disable = The UPS cannot start with a fully depleted battery (default)

Remote control

Allows the UPS to be controlled remotely via the CLI or RDU101 card.

- Enable (default)
- Disable

Any mode shutdown auto restart enable

Automatically restart the UPS after an “Any mode shutdown” signal is received. When the UPS is shut down via dry-contact inputs 1 or 2, it will restart automatically if this option is enabled.

- Enable
- Disable (default)

Output contact NO/NC

Selects the states of the dry contact outputs 5 and 6.

- Normally open (default)
- Normally closed

Input contact NO/NC

Selects the states of the dry contact inputs 1 and 2.

- Normally open (default)
- Normally closed.

Dry contact 5 (Output)

Selects the output of dry-contact 5.

- Low battery = The contacts switch when the UPS reaches the amount of time left on battery configurable from “Low battery time”. (default)
- On bypass = The contacts switch when the UPS is running in bypass mode
- On battery = The contacts switch when the UPS is running on battery
- UPS fault = The contacts switch when a UPS fault has occurred

Dry contact 6 (Output)

Selects the output of dry contact 6.

- Low battery = The contacts switch when the UPS reaches the amount of time left on battery configurable from “Low battery time”.
- On bypass = The contacts switch when the UPS is running in bypass mode
- On battery = The contacts switch when the UPS is running on battery
- UPS fault = The contacts switch when a UPS fault has occurred. (default)

Dry contact 1 (Input)

Selects the action taken by the UPS when the input of dry-contact 1 is triggered.

- Disable (default)
- Battery mode shutdown = If the UPS is running on batteries and this input is triggered, the UPS shuts down
- Any mode shutdown = If this input is triggered, the UPS shuts down regardless of current operating mode

Dry contact 2 (Input)

Selects the action taken by the UPS when the input of dry-contact 2 is triggered.

- Disable (default)
- Battery mode shutdown = If the UPS is running on batteries and this input is triggered, the UPS shuts down
- Any mode shutdown = If this input is triggered, the UPS shuts down regardless of current operating mode

Sleep mode

Allows the UPS to turn off the output on a weekly schedule. For instance, turn on every Monday at 1:00 and off every Friday at 23:00.

- Enable
- Disable (default)

Power on day of week

Sets the day of week to turn on the UPS. This option is only shown when sleep mode is enabled.

- Sunday-Saturday (default Monday)

Power on time

Sets the time of day to power on the UPS on the selected day. This option is only shown when sleep mode is enabled.

- 00:00 - 23:59 (default 00:00)

Power off day of week

Sets the day of week to turn off the UPS. This option is only shown when sleep mode is enabled.

- Sunday-Saturday (default Friday)

Power off time

Sets the time of day to power off the UPS on the selected day. This option is only shown when sleep mode is enabled.

- 00:00 - 23:59 (default 00:00)

IT system compatibility

When this option is enabled, the “Input phase reversed” and “Input ground lost” alarms are disabled.

- Enable
- Disable (default)

Outlet Parameter Options

Apply the same settings as outlet 1

Available on outlets 2 through 4, this applies the settings for Outlet1 to this outlet. This lets you apply the settings for Outlet1 and apply identical settings to any other programmable outlet.

Turn on/off outlet

Turns on or turns off the outlet based on the current state. Provides a confirmation window with Yes/No options to confirm turning on the outlet.

Turn on delay

Length of time before outlet turns on after UPS start-up.

- 0 to 30 minutes (default is 0)

Turn off when UPS overloads

Sets whether or not to turn off the outlet if the UPS is overloaded while on battery power. This can be used to disable lower priority equipment in the event of an overload while in battery mode.

- Yes
- No (default)

Outlet settings based on discharging time

Threshold of turning off the outlet

Length of time that the outlet is powered after the batteries begin to discharge. Select the checkbox to enable or disable (default) the option.

- 0 to 30 minutes (default is 5)

Turn on when power returns for

Length of time after the mains input power returns before turning on the outlet. Select the checkbox to enable (default) or disable the option.

- 0 to 30 minutes (default is 5)

Outlet settings based on backup time

Threshold of turning off the outlet

When the selected amount of time remains on battery mode, the outlet is turned off. Select the checkbox to enable or disable (default) the option.

- 0 to 30 minutes (default is 5)

Turn on when power returns for

Length of time after the mains input power returns before turning on the outlet. Select the checkbox to enable or disable (default) the option.

- 0 to 30 minutes (default is 0)

Outlet settings based on capacity

Threshold of turning off the outlet

When the selected percentage of capacity remains in battery mode, the outlet turns off. Select the checkbox to enable or disable (default) the option.

- 20 to 80% (default is 20%)

Turn on when power returns

Length of time after the mains input power returns before turning on the outlet. Select the checkbox to enable or disable (default) the option.

- 0 to 30 minutes (default is 0)

4.2.5. Control Screen

The Control screen offers UPS-control options.

To adjust the UPS controls:

1. At the main menu, select the Control icon, and press **Enter**.
2. Use the arrow buttons to move the cursor to the option, then press **Enter** to select the control.

Figure 4-6 Control Screen

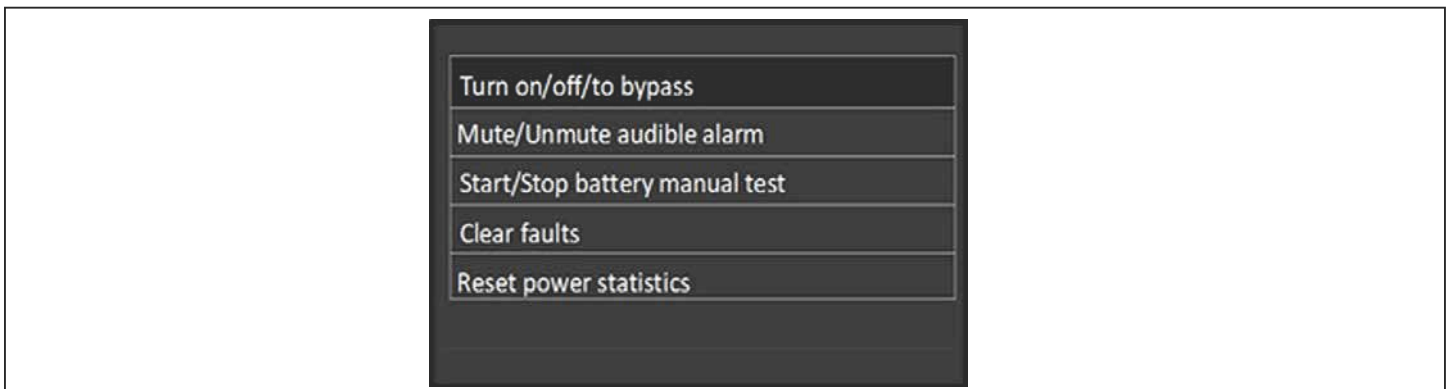

Control Options

Turn on/off/to bypass

Opens the dialog to change operating modes, see [Operating the UPS](#) on [page 21](#).

Mute/Unmute audible alarm

Silences or un-silences the audible alarm, see [Silencing the Audible Alarm](#) on page 21.

Start/Stop battery manual test

Starts the battery self test manually. If the manual self test is already running, stop the self test.

Clear faults

Clears displayed faults after the issue causing the fault is resolved, see [Table 6-2](#) on page 64, for a description of the faults.

Reset power statistics

Resets the values tracked to calculate the Efficiency graph, see [About Screen](#) on page 45.

4.2.6. Log Screen

The Log Screen offers tabs that list the current alarms and the alarm/event history. [Table 4-4](#) below, describes the alarm messages you may see in the logs.

To view the logs:

1. At the main menu, select the Log icon, and press **Enter**.
2. Use the arrow buttons to move the cursor left/right and select a tab, then press **Enter** to display the log for the selected tab.
3. Use the arrow buttons to scroll up/down through the log.

Figure 4-7 Current and History Log Tabs

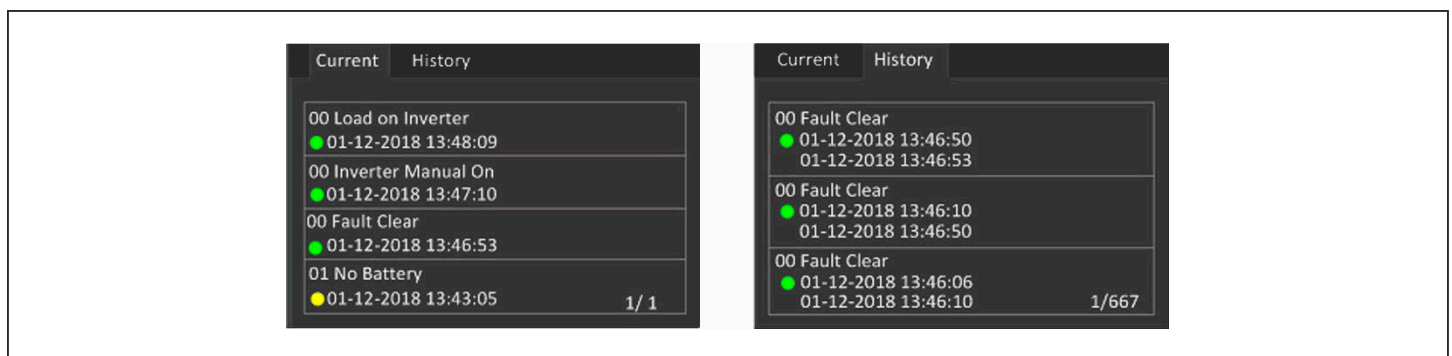

Table 4-4 Alarm Messages

MESSAGE	DESCRIPTION
Aux. power fault	UPS internal auxiliary power voltage fault. Contact Vertiv Technical Support.
Battery cabinet connect abnormal	More than 10 external battery cabinets are connected to the UPS. Disconnect excess battery cabinets.
Battery EOD	The battery has reached the end of discharge and mains/utility power is unavailable. Restore the mains power. The UPS will power off if it is not restored.
Battery low pre-warning	This alarm occurs when the battery approaches the EOD. After the pre-warning, the battery capacity allows two minutes discharge at full load. The user can set the time with the Low Battery Time setting in Battery settings from 2 min - 30 min, (2 min by default). This allows for any loads to be shut down before the system powers off if utility power cannot be restored.
Battery mode	The UPS operating in battery mode. The alarm will clear when utility power is restored.
Battery overtemp	Battery ambient temperature too high. Ensure that the battery ambient temperature is not higher than setting value 40 ~ 60 °C (default: 50 °C)
Battery replacement timeout	The system time is past the time set for the batteries to be replaced. If you have disabled the "Batt. note duration" or have no batteries installed, the alarm will not occur.
Battery reversed	The battery positive and negative are reversed. Reconnect the battery and check the battery cable connections.
Battery test fail	The voltage of the battery was low when the periodic or manual self-test was run. Battery replacement is Recommended.
Battery test started	The battery periodic self-test or manual self-test was started. This will display in the log whenever the event occurs.
Battery test stopped	The battery periodic self-test or manual self-test has finished. This will display in the log whenever the event occurs.
Battery to utility transition	The UPS has transferred the load to the mains power from the battery. This will display in the log whenever the event occurs.
Battery voltage abnormal	The battery voltage exceeds the normal range. Check if the battery terminal voltage exceeds the normal range.
Bypass abnormal	May be caused by bypass voltage and frequency outside of range, bypass power-off and incorrect bypass cables connection. Check that the bypass voltage and frequency are within the setting range. Check the bypass cables connection
Bypass abnormal in ECO mode	May be caused by ECO bypass voltage and frequency outside of range, ECO bypass power-off, and incorrect ECO bypass cables connection. Check that the ECO bypass voltage and frequency are within the setting range. Check the bypass cable connection
Bypass mode	The UPS is on bypass. This will clear when the UPS returns to Normal mode.
Bypass over-current	The load is drawing more current than the UPS is rated to supply in bypass mode. Reduce the load.
Charger fault	The charger output voltage is abnormal and the charger is off. Contact Vertiv Technical Support.
Communication fail	Internal communication is abnormal. Check that the communication cables are connected correctly.
DC bus abnormal	The inverter is off due to DC bus voltage out of acceptable range. The load will transfer to bypass if the bypass is available because the bus voltage is outside of the acceptable range.
DC/DC fault	The discharger is faulty, because the bus voltage exceeds the range when the discharger starts. Contact Vertiv Technical Support.
EOD turn off	The inverter is off due to EOD. Check the mains power-off state and restore the mains in time
Fan fault	At least one fan is faulty. Check if the fan is blocked or the cable connection is loose.
Faults cleared	The faults have been cleared using Settings > Controls > Clear faults. This will display in the log whenever the event occurs.
Guaranteed shutdown	The battery has finished discharging, then system shuts down because Guaranteed Shutdown is enabled (see Guaranteed shutdown on page 37). This alarm will clear when the UPS is turned on again.
Input abnormal	The rectifier and charger are off due to the mains voltage and frequency exceeding the normal range. Check that the rectifier input phase voltage and frequency exceed the normal range or that the mains has power-off
Input ground lost	Check that the PE line is well connected and that the alarm can be cleared at the display.
Input phase reversed	The mains input line and neutral are reversed. Shut off external input breaker and connect the lines correctly.
Insufficient capacity to start	The UPS is on bypass and is started with a load greater than 105% of the rated capacity. Reduce the load to the rated capacity or below to start the unit.
Inverter fault	The inverter is turned off when the inverter output voltage or current exceed the ranges set. If bypass is available, the UPS will transfer to bypass mode, otherwise the system will power off. Contact Vertiv Technical Support.

Table 4-4 Alarm Message (continued)

MESSAGE	DESCRIPTION
Inverter overload	Inverter load capacity is larger than the rated value, overload delay time is up, inverter shuts down. If bypass is available, the system will transfer to the bypass mode, otherwise the system will power off. Check the output load. If overloaded, reduce the load, and the system will transfer to the inverter mode after five seconds with no alarm.
Load off due to output short	A short has occurred on the output. Check the output cables and for any equipment that may have shorted.
Load off due to shutdown on battery	The system was shut down in battery mode. This will clear when the system is turned back on.
Manual power- on	The system was turned on via the display panel. This will display in the log whenever the event occurs.
Manual shutdown	The system was shut down via the display panel. This will display in the log whenever the event occurs.
Manual shut-off	Displayed when the user shuts-down UPS output. This will display in the log whenever the event occurs.
No battery	No battery detected. Check the battery and battery cable connection(s).
Operating on inverter	The UPS output is being powered by the inverter. This will display in the log whenever the event occurs.
Output disabled	The system is in standby state and the dry contact shutdown is enabled. Check if the shutdown dry contact is enabled.
Output off due to bypass abnormal	The bypass voltage or frequency is outside the acceptable range, and the bypass is in stand-by mode. Check that the input is normal.
Output off due to overload & bypass abnormal	The output is off due to an overload of the UPS output, and the bypass voltage or frequency is outside the acceptable range. Check that the input is normal.
Output off, voltage is not zero	This occurs when the output is off and the system detects that there is still voltage on the output. Check output equipment for backfeeds or contact Vertiv Technical Support.
Output pending	Remote shutdown has been initiated, and the system will turn off shortly.
Output short	A short has occurred on the output. Check the output cables and for any equipment that may have shorted.
Output voltage abnormal	The output voltage is outside the normal voltage range. The UPS will power off. Check output settings or contact Vertiv Technical Support.
Rectifier fault	The rectifier is off because the bus voltage is out of the acceptable range when the rectifier starts. Contact Vertiv Technical Support.
Rectifier overload	The output power is larger than the rectifier overload point. Check that the input voltage meets the output load, mains input 176 V ~ 100 V, the load 100% ~ 50% linear derating.
Remote power- on	The UPS was powered on remotely. This will display in the log whenever the event occurs.
Remote shut- off	The UPS was powered off remotely. This will display in the log whenever the event occurs.
Remote shutdown	Any mode shutdown was initiated by the dry contact input. This will display in the log whenever the event occurs.
REPO	Shutdown caused by the REPO terminal Normally-Closed contact input opening. This will display in the log whenever the event occurs.
Restore factory defaults	On the Maintenance page, "Restore Factory Defaults" has been set while the UPS is in the stand-by state. This will return settings to their factory settings.
Shutdown due to over temp	During the UPS operation, the system checks if the heat sink temperature exceeds the setting range. If an overtemperature occurs, check if : 1. The ambient temperature is too high. 2. Dust is blocking any of the UPS vents. 3. A fan fault has occurred.
System fault	This alarm occurs when the model configuration is incorrect. Contact Vertiv Technical Support.
System over temp	The internal heat-sink temperature is too high, and the inverter is off. The alarm can only be silenced if the heat-sink temperature is lower than the alarm setting. The system can automatically start after overtemperature fault is corrected. If an overtemperature occurs, check if : 1. The ambient temperature is too high. 2. Dust is blocking any of the UPS vents. 3. A fan fault has occurred.
Turn on fail	The UPS does not start because there is no mains/utility power or it is outside of the range of the voltage required to supply the full load. Check the AC input power.

Table 4-4 Alarm Message (continued)

MESSAGE	DESCRIPTION
UPS has no output	Both Inverter and Bypass are not supplying power due to the UPS output being turned off remotely or via the LCD, or are unavailable due to no input power or input power out of range. Check that UPS is on and input power is available.

4.2.7. About Screen

The About screen offers tabs that list information about the product.

- Product tab—shows UPS identification information, firmware versions, and information about the communication card (when the card is installed).
- Efficiency tab—shows the curve of the efficiency of your UPS model vs the load. Also shows the output load percentage and the efficiency at that load.
- Battery age tab—shows the curve of the percent state-of-health (SOH) of the installed battery versus time. The UPS calculates one value per week and plots it on the graph. The values are based on the battery temperature, age, and the actual amount of energy discharged from the battery if the battery has been discharged fully.

To view the product, efficiency, and battery-age information:

1. At the main menu, select the About icon, and press **Enter**.
2. Use the arrow buttons to move the cursor left/right and select a tab, then press **Enter** to display the information for the selected tab.

Figure 4-8 About Screen Tabs

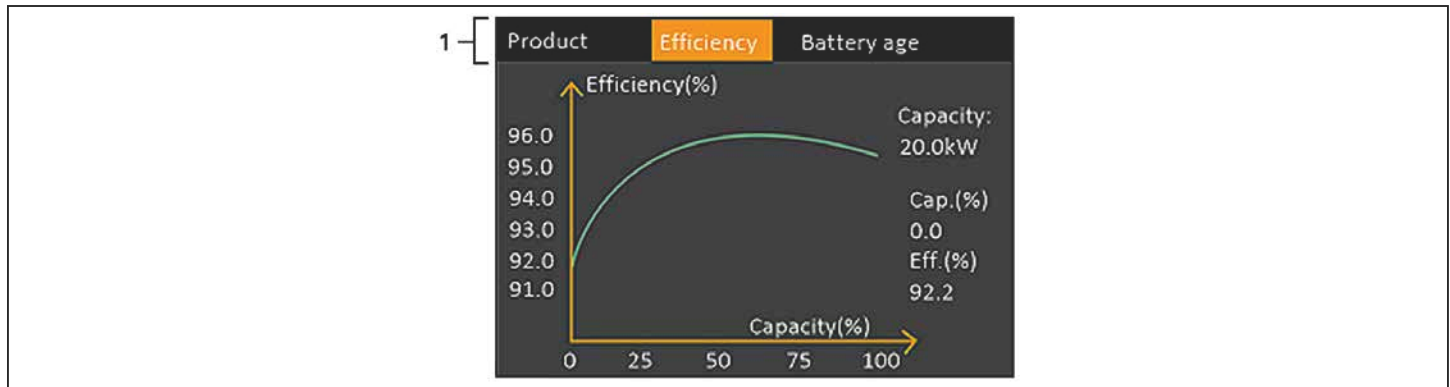

ITEM	DESCRIPTION
1	About screen tabs with Efficiency tab selected. Note: The tab shown in the figure is an example of the graph and does not represent the actual capacity values for your UPS model.

Product Information

Product Type

UPS model number.

Serial number

UPS serial number.

Time since startup

Elapsed time since start-up of the UPS.

Boot FW version

Version of MCU boot firmware on the monitor board.

Monitor FW version

Version of MCU application firmware on the monitor board.

DSP FW version

Version of DSP firmware on the UPS power-module.

MAC address

Shows the MAC address of the RDU101 card. This is only shown when the RDU101 card is installed.

IPv4 address

Shows the IPv4 address of the RDU101 card. This is only shown when the RDU101 card is installed.

Subnet mask

Shows the subnet mask of the RDU101 card. This is only shown when the RDU101 card is installed.

Gateway address

Shows the gateway address of the RDU101 card. This is only shown when the RDU101 card is installed.

Efficiency Tab**Capacity**

This shows the maximum capacity of your UPS model.

Cap. (%)

This shows the percentage of the maximum capacity your UPS is currently using.

Eff. (%)

This shows the efficiency the UPS is currently operating at based on the Cap. (%) value.

Battery Age

This page also displays the following values:

Battery recommended replacement date

This shows the date that it is recommend to replace the battery. It is 5 years from the time the battery was installed.

SOH (%)

This shows the current SOH percentage.

4.3. Editing Display and Operation Settings

You may adjust the display settings and UPS configuration via the LCD. The display and operation settings are password protected. The default password is 111111 (six ones).

NOTE: We recommend that you change the password to protect your system and equipment and record the new password and store it in an accessible location for later retrieval. See [Changing the Password](#) on the next page.

To enter the password:

1. Press the up-arrow button to change the digit, then press the down-arrow button to move to the next digit.
2. Repeat to select each digit, and press **Enter** to submit the password.

Figure 4-9 Password Prompt

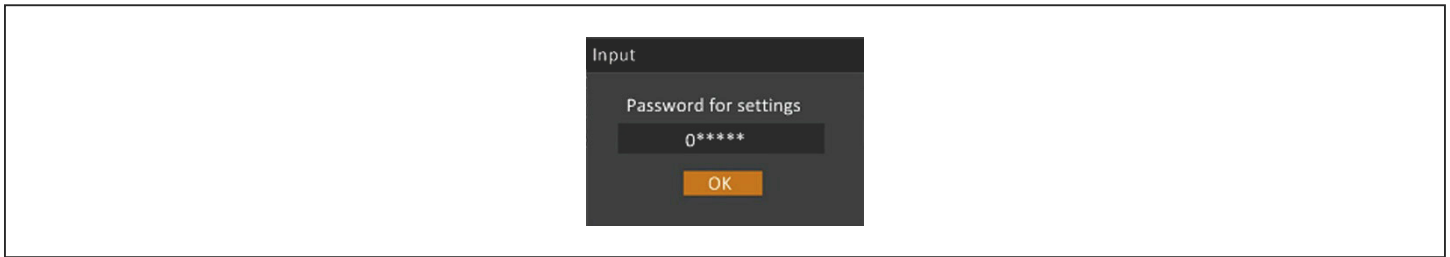

4.3.1. Settings Prompts

While using the operation and display panel, prompts display to alert you to specific conditions or require confirmation of commands or settings. [Table 4-5](#) lists the prompts and their meaning.

Table 4-5 Display Prompts and Meanings

PROMPT	MEANING
Cannot set this online, please shut down output	Appears when changing important output settings (output voltage, output frequency, output phase No.).
Incorrect password, please input again	Appears when the Settings password is input incorrectly.
Operation failed, condition is not met	Appears when attempting to execute a operation for which the required conditions are not met.
Password changed OK	Appears upon successful change of the Settings password.
Fail to change password, please try again	Appears when attempting to change the Settings password but the new and confirmation passwords do not match.
The time cannot be earlier than system time	Appears when attempting to set the time of 'Turn on delay' or 'Turn off delay' earlier than the current system time.
Turn on failed, condition is not met	Appears when proper conditions are not met for UPS power-on. Applies when using the power button or when execute the command of 'Turn on/Turn off/to Bypass' on the LCD panel 'Control' page).
Cannot set this on line, please unplug REPO	Appears when attempting to change the output phase number while the output is connected.

4.3.2. Changing the Password

The default password is 111111 (six ones). You must use the current password to change the password.

NOTE: We recommend that you change the password from the default to protect your system and equipment. Record the new password and store it in an accessible location for later retrieval.

1. At the main menu, select the Settings icon, and press **Enter**.
2. At the password prompt, use the up-arrow to select the first digit, press the down-arrow to move to the next digit, repeat for each digit, then press Enter to access the settings.
3. Use the arrow buttons to select the Monitor tab, then press **Enter**.
4. Use the down arrow to highlight *Change Settings Password*, press **Enter**, and re-enter the current password. The Input new password dialog opens, see [Figure 4-10](#) below.
5. Enter the new password, then confirm the new password.
A confirmation dialog opens to indicate a successful password change.
6. Press **ESC** to return to the settings or main menu.

Figure 4-10 New and Confirm Password dialogs

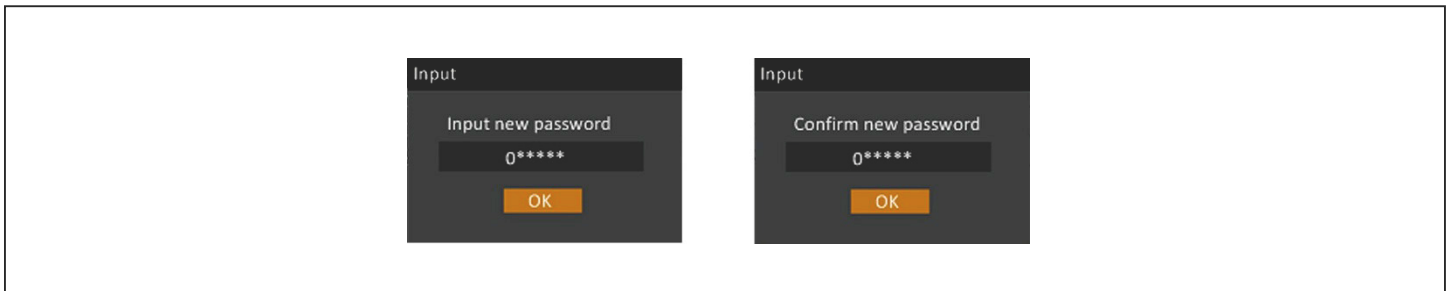

4.3.3. Selecting the Display Language

The LCD is multilingual. The available languages are English, French, Portuguese, Spanish, Chinese, German, Japanese, and Russian.

To change the language:

1. At the main menu, select the Settings icon, and press **Enter**.
2. At the password prompt, use the up-arrow to select the first digit, press the down-arrow to move to the next digit, repeat for each digit, then press **Enter** to access the settings.
3. Use the arrow buttons to select the Monitor tab, then press **Enter**.
4. Use the down arrow to highlight *Language*, then press **Enter**.
5. Use the up/down arrows to select the language, then press **Enter**.
All the LCD elements will now display in the selected language.

4.3.4. Setting the Date and Time

To adjust the date and time:

1. At the main menu, select the Settings icon, and press **Enter**.
2. At the password prompt, use the up-arrow to select the first digit, press the down-arrow to move to the next digit, repeat for each digit, then press **Enter** to access the settings.
3. Use the arrow buttons to select the Monitor tab, then press **Enter**.
4. Use the down arrow to highlight *Date* or *Time*, then press **Enter**.
5. Use the up/down arrows to select the date/time, then press **Enter** to confirm.
6. Use the down arrow to select the digit to change and the up arrow to select the correct digit. Repeat as needed to set each digit.

This page is intentionally left blank.

Chapter 5: Maintenance



WARNING! Risk of electric shock

Can cause equipment damage, injury and death. A battery can present a risk of electrical shock and high short-circuit current.



WARNING! Risk of electric shock

Can cause injury or death. Hazardous mains and/or battery voltage exists behind the protective cover. No user accessible parts are located behind the protective covers that require a tool for removal. Only qualified service personnel are authorized to remove such covers. If maintenance for rack is needed, notice that the neutral line is live.

Observe the following precautions when working on batteries:

- Remove watches, rings and other metal objects.
- Use tools with insulated handles.
- Wear rubber gloves and boots.
- Do not lay tools or metal parts on top of batteries.
- Disconnect charging source prior to connecting or disconnecting battery terminals.
- If the battery kit is damaged in any way or shows signs of leakage, contact your Vertiv representative immediately.
- Handle, transport, and recycle batteries in accordance with local regulations.
- Determine if the battery is inadvertently grounded. If it is inadvertently grounded, remove the source of the ground. Contact with any part of a grounded battery can result in electrical shock. The likelihood of such shock will be reduced if grounds are removed during installation and maintenance (applicable to a UPS and a remote battery supply not having a grounded supply circuit).

5.1. Replacing Batteries



WARNING! Risk of electric shock

Can cause injury or death. Disconnect all local and remote electric power supplies before working with the UPS. Ensure that the unit is shut down and power has been disconnected before beginning any maintenance.



WARNING! Risk of electric shock and explosion

Can cause equipment damage, injury and death. Do not dispose of the battery in a fire. The battery may explode. Do not open or damage the battery. Released electrolyte is toxic and is harmful to skin and eyes. If electrolyte comes into contact with the skin, wash the affected area immediately with plenty of clean water and get medical attention.



WARNING! Risk of electric shock

Can cause equipment damage, injury and death. A battery can present a risk of electrical shock and high short-circuit current.



WARNING! Risk of explosion

Can cause equipment damage, injury and death. A battery can explode if the battery is replaced by an incorrect type. Dispose of used batteries according to the instructions included with the battery-pack.

Read all safety cautions before proceeding. A trained user can replace the internal battery pack when the UPS is in a restricted access location (such as a rack or server closet). To obtain the appropriate replacement battery pack(s), refer to [Table 5-1](#) below, and contact your local dealer or Vertiv representative.

Table 5-1 Replacement Battery-pack Model Numbers

UPS MODEL NUMBER	BATTERY PACK MODEL NUMBER	QUANTITY REQUIRED
GXT5-500LVRT2UXL	GXT5-36BATKIT	1
GXT5-750LVRT2UXL		
GXT5-1000LVRT2UXL(TAA)		
GXT5-1500LVRT2UXL(TAA)	GXT5-48BATKIT	1
GXT5-2000LVRT2UXL(TAA)		
GXT5-3000LVRT2UXL(TAA)		
GXT5-3000LVRT2UXL(TAA)	GXT5-72BATKIT	1

To replace a battery pack:

NOTE: The internal battery pack is hot-swappable. However, you must exercise caution because; during this procedure, the load is unprotected from disturbances and power outages. Do not replace the battery while the UPS is operating in Battery Mode. This will result in a loss of output power and will drop the connected load.

1. Press the button on the left-front of the UPS front panel, and pull the panel open, then, loosen and remove the screw from the battery door, see [Figure 5-1](#) on the next page.
2. Lay the battery door and screw aside for reassembly.
3. Grasp the battery handle, and pull out the battery pack, see [Figure 5-1](#) on the next page.
4. Unpack the replacement battery pack, taking care not to damage the packaging to re-use when disposing of the old battery.
5. Compare the new and old battery pack to make sure they are the same type and model. If so, proceed with step 6. If they are different, stop and contact your Vertiv representative, or Technical Support, <http://www.Vertiv.com/en-us/support/>.
6. Line-up and slowly push-in each replacement battery pack. The battery is fully-inserted if the battery door fits flush against the UPS.
7. Re-attach the battery door with the screw, and replace the front cover.

8. Activate the new battery pack(s) using the operating/display panel.

NOTE: The display menus and functions are described in [Operation and Display Panel](#) on page 25.

- From the main menu, select *Settings*, then the Monitoring tab and verify that the date and time are correct. If the date or time need correction, see [Setting the Date and Time](#) on page 49.
- Select the *Battery* tab, use the arrows to select Replace Battery, and press Enter. The replaced battery packs are activated.
- Use **ESC** to return to the main display.

Figure 5-1 Replacing the Battery Pack

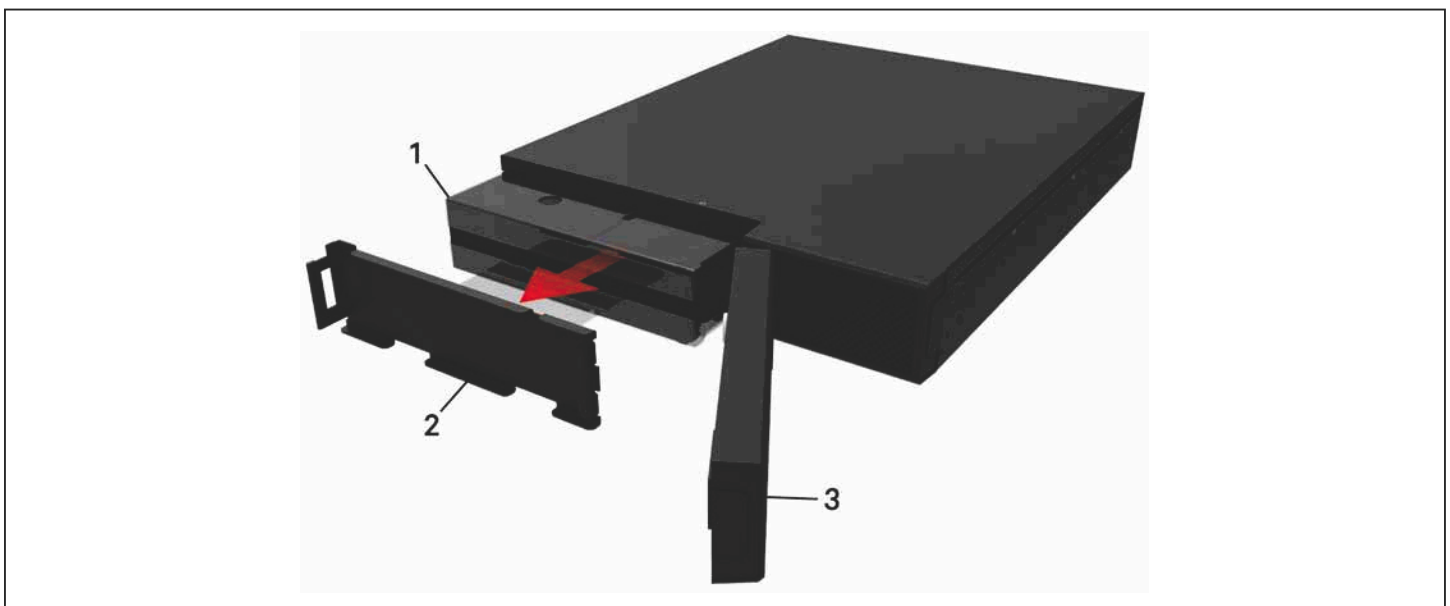

ITEM	DESCRIPTION
1	Battery pack
2	Battery door
3	Front panel

5.2. Charging Batteries

The batteries are valve-regulated, non-spillable, lead acid and should be kept charged to attain their design life. The UPS charges the batteries continuously when it is connected to the utility input power.

If the UPS will be stored for a long time, We recommend connecting the UPS to input power for at least 24 hours every 4 to 6 months to ensure full recharge of the batteries.

5.3. Checking UPS Operation

NOTE: Operation-check procedures may interrupt power supply to the connected load.

We recommend checking the UPS operation once every 6 months. Ensure that output power loss to the connected load will not cause data loss or other errors before conducting the check.

1. Press the **Enter** button to check the indicators and display function.
2. Check for alarm or fault indicators on the operation/display panel.
3. Make sure that there are no audible or silenced alarms. Select the Log, and look at the Current tab for alarm and fault history, see [Log Screen](#) on [page 42](#).
4. Check the flow screen to ensure the UPS is operating in Normal mode. If the UPS is operating in Bypass mode, contact Vertiv Technical Support.
5. Check the flow screen to see if batteries are discharging (operating in Battery mode) while utility power is normal. If so, contact Vertiv Technical Support.

5.4. Cleaning the UPS



WARNING! Risk of electric shock

Can cause injury or death. Disconnect all local and remote electric power supplies before working with the UPS. Ensure that the unit is shut down and power has been disconnected before beginning any maintenance.



WARNING! Risk of electric shock

Can cause injury or death. Hazardous mains and/or battery voltage exists behind the protective cover. No user accessible parts are located behind the protective covers that require a tool for removal. Only qualified service personnel are authorized to remove such covers. If maintenance for rack is needed, notice that the neutral line is live.

The UPS requires no internal cleaning. If the outside of the UPS becomes dusty, wipe with a dry cloth. Do not use liquid or aerosol cleaners. Do not insert any objects into the ventilation holes or other openings in the UPS.

5.5. Firmware Updates

The UPS has two firmware components:

- DSP is the firmware for the power module.
- MCU is the firmware for the display panel.

Both may be updated through a connection the UPS, using CLI and the R232 port or, if the UPS includes the IntelliSlot RDU101 card, using the RJ-45 port on the card.

The latest firmware is available for download from the GXT5 product page at www.Vertiv.com. Refer to [Table 5-2](#) below, and make sure you have the correct files for the update.

Table 5-2 Upgrade File Names by UPS Model

UPS MODEL NUMBER	DSP FIRMWARE FILENAME	MCU FIRMWARE FILENAME
GXT5-500LVRT2UXL GXT5-750LVRT2UXL GXT5-1000LVRT2UXL(TAA) GXT5-1500LVRT2UXL(TAA) GXT5-2000LVRT2UXL(TAA) GXT5-3000LVRT2UXL(TAA)	GXT5_Micro_0.5k-3k_P***.bin	GXT5_M***.bin
<p>For DSP update files:</p> <ul style="list-style-type: none"> • “P” represents the power module. The number following “P” is the version of the power module. • “D” represents the rectifier and inverter module. The number following “D” is the version of the rectifier and inverter module. • “K” is included after the version for the DSP kernel upgrade file, for example: GXT5_Micro_0.5k-3k_P***K.bin) <p>For MCU update files: “M” represents the MCU module. The number following “M” represents the MCU software version.</p>		

5.5.1. Updating Firmware with RDU101 Card Connection

If your UPS has an IntelliSlot RDU101 communication card installed (optional on some models), you can update firmware with a computer connected to the same network as the card.

NOTE: The RDU101 card is password protected. Be sure to obtain the user name and password from an administrator. The name and password may have been changed from the default.

NOTE: For detailed operating instructions for the card, refer to the Liebert® IntelliSlot™ RDU101 Communications Card Installer/User Guide, available at www.Vertiv.com.

Updating MCU Firmware via RDU101

NOTE: Do not update firmware while the UPS is on Battery mode.

1. Connect a network cable to the RJ-45 Ethernet port of the RDU101 card. For the card/connection location, refer to the appropriate rear-panel description for your UPS model in [Rear Panels](#) on [pages 4-6](#).
2. On a computer connected to the same network as the RDU101, open a browser window and enter the IP address of the RDU101 card in the address bar.

You can get the card’s IP address from the display panel. Select the About menu then the Product tab, and locate IPv4 address.

NOTE: We recommend using the Google Chrome browser.

3. Upload the update file using the card’s user interface, see [Figure 5-2](#) on the next page.
 - a. Select the “GXT5” tab, then the File Transfer folder in the tab-menu pane on the left-hand side of the page.
 - b. On the file-transfer page, click Choose File, and select the MCU upgrade file, then click Transfer file.

c. Enter the Username and Password, then click Login.

The factory-defaults:

Username : Liebert (case-sensitive)

Password: Liebert (case-sensitive)

NOTE: The name and password may have been changed from the default. Be sure to obtain the username and password from an administrator.

The status of the transfer displays in the File Transfer Status section. After about 2 minutes, the UPS restarts and the web page refreshes.

NOTE: The transfer process takes about 2 minutes. Do not leave or close the page until the status is “Update Complete.”

d. You can check the firmware version, select the System folder in the tab-menu pane on the left-hand side of the page, and check the Firmware Version field, see [Figure 5-3](#) on the next page.

Figure 5-2 File Transfer on the RDU101 User Interface

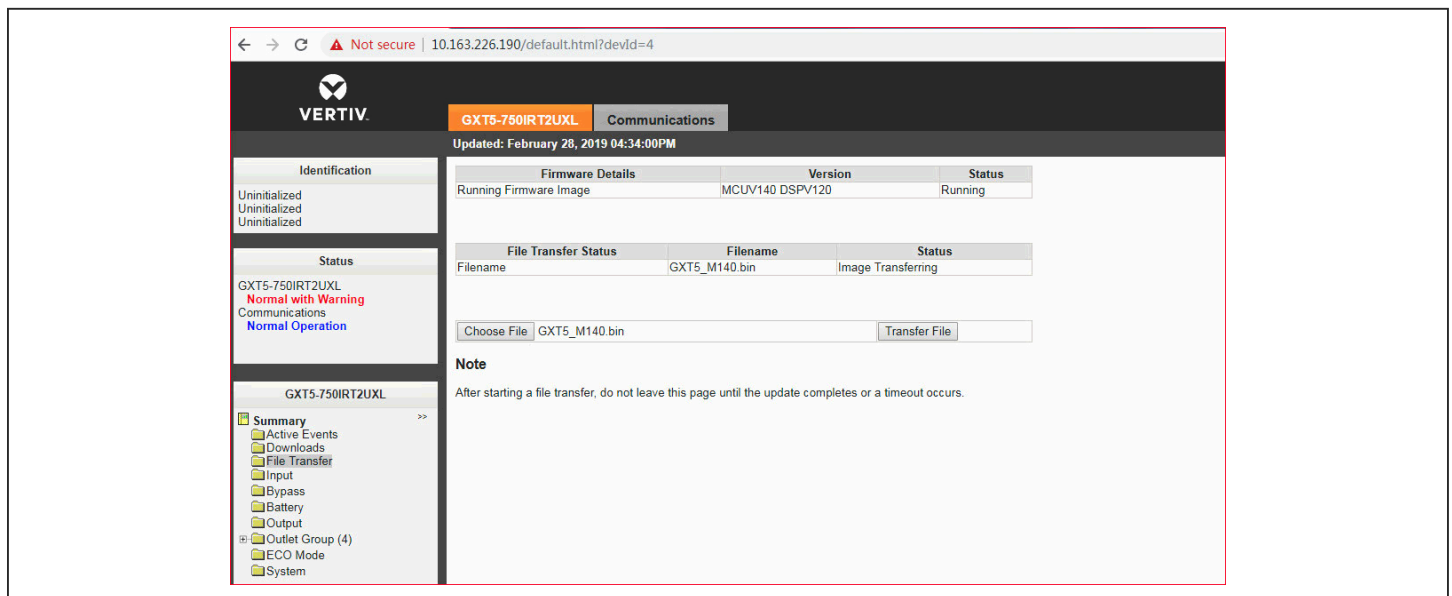

ITEM	DESCRIPTION
1	"UPS" tab, typically the UPS model number
2	File Transfer folder
3	Choose File button
4	Transfer File button
5	Status of file transfer

Figure 5-3 Firmware Version on the RDU101 User Interface

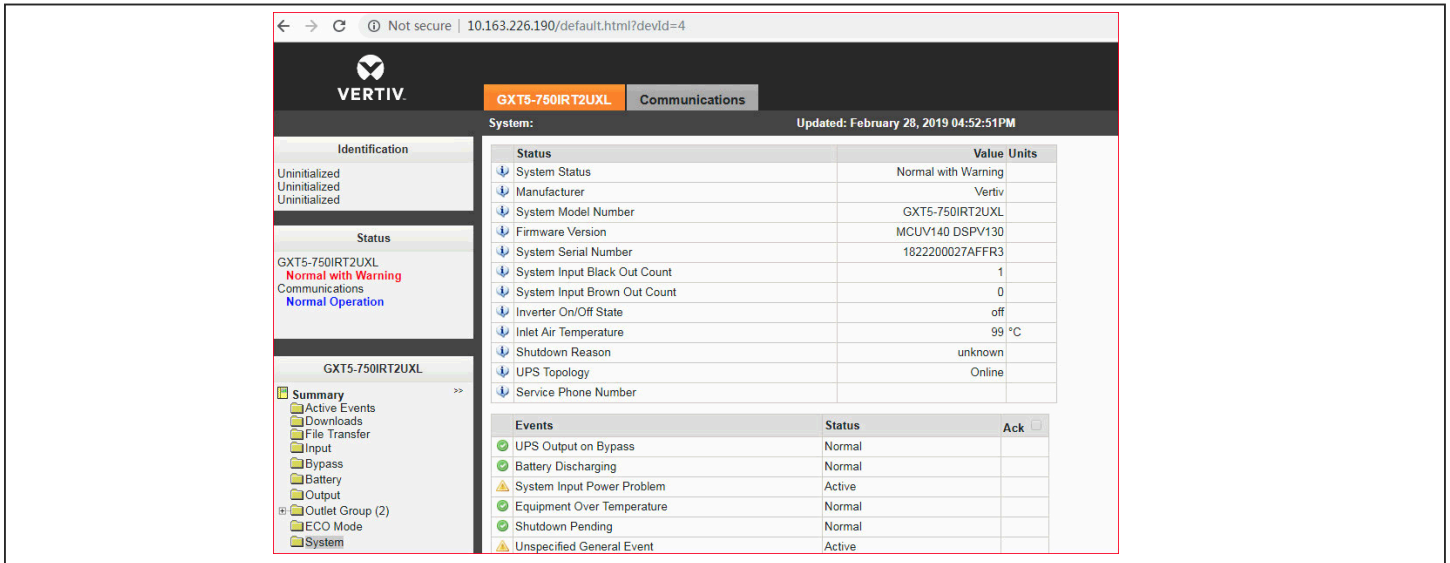

5.6. Updating DSP Firmware via RDU101

NOTE: Only update the DSP firmware while the UPS is in Stand-by mode. The REPO terminal of the UPS must be un-plugged. When the REPO terminal is unplugged the load will lose power. Do not update firmware while the UPS is on Battery mode.

1. Disconnect the REPO terminal from the rear panel of the UPS, see [Figure 5-4](#) below.

Figure 5-4 REPO Terminal

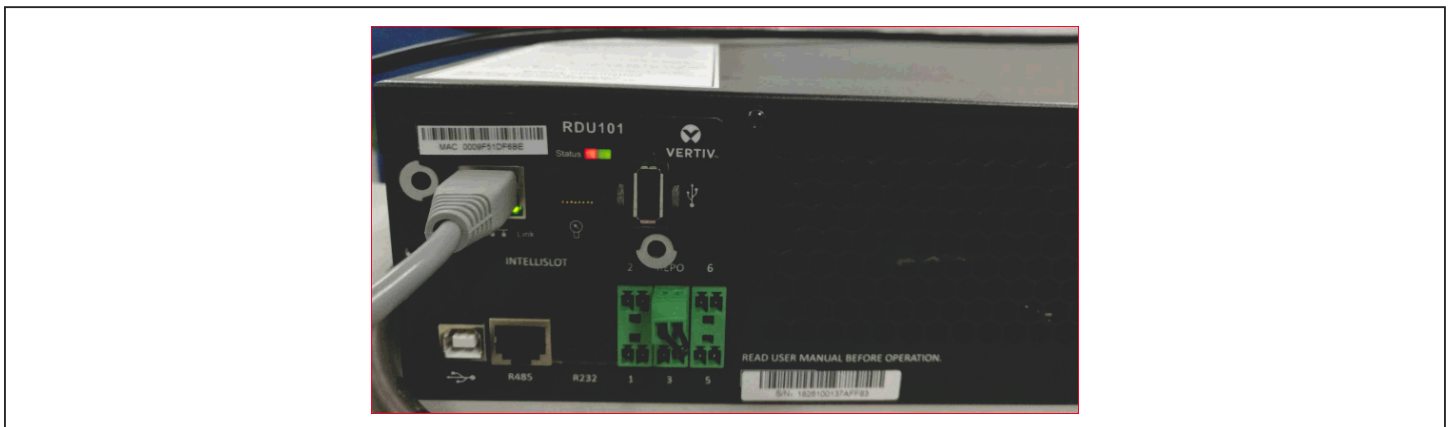

2. Connect a network cable to the RJ-45 Ethernet port of the RDU101 card. For the card/connection location, refer to the appropriate rear-panel description for your UPS model in [Rear Panels](#) on [page 5](#).
3. On a computer connected to the same network as the RDU101, open a browser window and enter the IP address of the RDU101 card in the address bar. You can get the card's IP address from the display panel. Select the About menu then the Product tab, and locate IPv4 address.

NOTE: We recommend using the Google Chrome browser.

4. Upload the update file using the card's user interface, see [Figure 5-5](#) below.

a. Select the “GXT5” tab, then the File Transfer folder in the tab-menu pane on the left-hand side of the page.

b. On the file-transfer page, click Choose File, and select the DSP upgrade file, then click Transfer file.

c. Enter the Username and Password, then click Login.

The factory-defaults:

Username : Liebert (case-sensitive)

Password: Liebert (case-sensitive)

NOTE: The name and password may have been changed from the default. Be sure to obtain the user name and password from an administrator.

The status of the transfer displays in the File Transfer Status section. After about 2 minutes, the UPS restarts and the web page refreshes.

NOTE: The transfer process takes about 2 minutes. Do not leave or close the page until the status is “Update Complete.”

d. You can check the firmware version, select the System folder in the tab-menu pane on the left-hand side of the page, and check the Firmware Version field, see [Figure 5-6](#).

Figure 5-5 File Transfer on the RDU101 User Interface

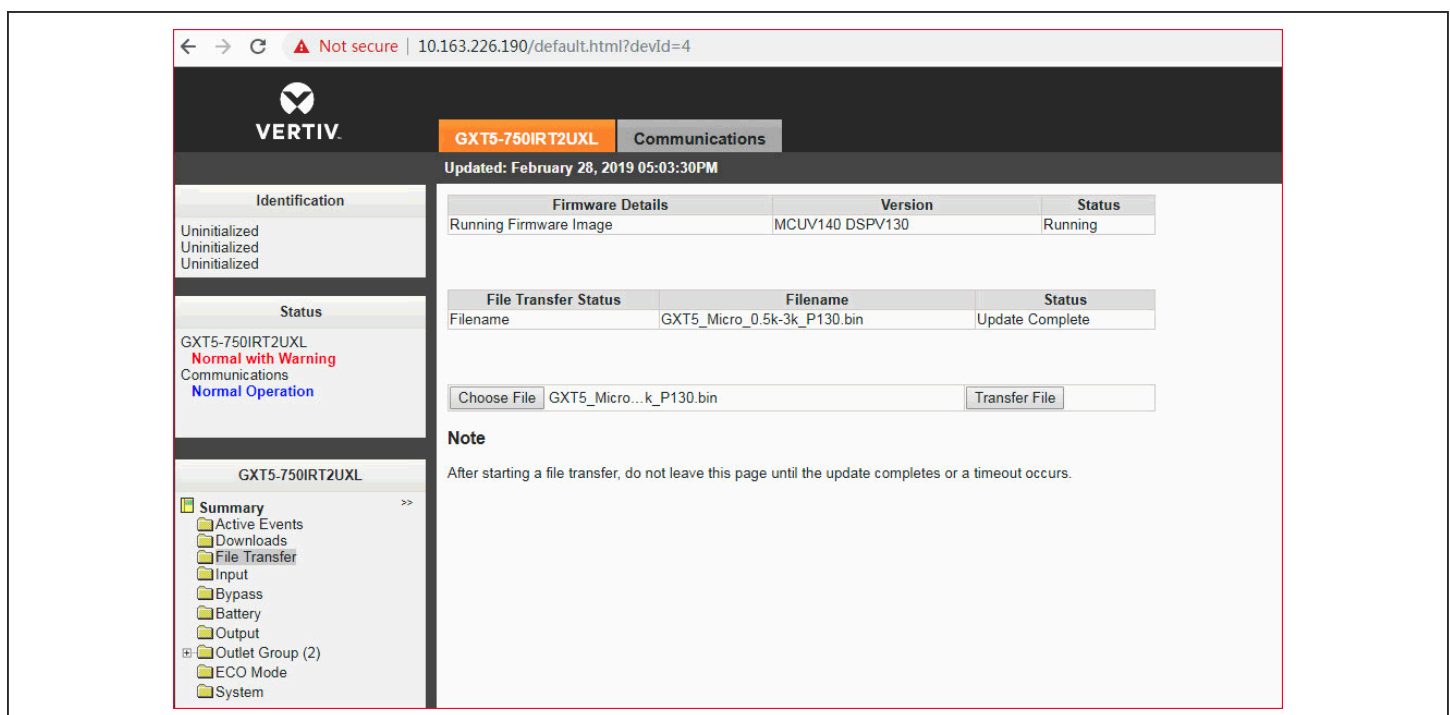

Figure 5-6 Firmware Version on the RDU101 User Interface

The screenshot displays the Vertiv RDU101 User Interface. The browser address bar shows '10.163.226.190/default.html?devId=4'. The interface includes a navigation menu on the left with sections for Identification, Status, and a Summary tree. The main content area is divided into a 'System' information section and a table of system parameters.

System Information:
 System: GXT5-750IRT2UXL
 Updated: February 28, 2019 05:15:19PM

Status	Value	Units
System Status	Normal with Warning	
Manufacturer	Vertiv	
System Model Number	GXT5-750IRT2UXL	
Firmware Version	MCUV140 DSPV130	
System Serial Number	1822200027AFFR3	
System Input Black Out Count	1	
System Input Brown Out Count	0	
Inverter On/Off State	off	
Inlet Air Temperature	100	°C
Shutdown Reason	unknown	
UPS Topology	Online	
Service Phone Number		

Events	Status	Ack
UPS Output on Bypass	Normal	<input type="checkbox"/>
Battery Discharging	Normal	<input type="checkbox"/>
System Input Power Problem	Active	<input type="checkbox"/>
Equipment Over Temperature	Normal	<input type="checkbox"/>
Shutdown Pending	Normal	<input type="checkbox"/>
Unspecified General Event	Active	<input type="checkbox"/>

5.7. Updating Firmware with a CLI Connection

You can use the Vertiv command-line interface to update firmware with a computer connected to the R232 (RJ-45) port on the rear of the UPS.

To perform the update via CLI, you need the following:

- Serial-terminal emulator with Ymodem transfer ability (for example: ExtraPuTTY)
- Cable with RJ-45 connector on one end and DB9 connector on the other or an RJ45/FTDI USB serial-port adapter

Updating MCU Firmware via CLI

NOTE: Do not update firmware while the UPS is on Battery mode.

1. Connect the RJ-45 connector to the R232 port on UPS. For the connection location, refer to the appropriate rear-panel description for your UPS model in [Rear Panels](#) on [pages 4-6](#).
2. Connect the DB9/USB connector to the computer with the serial-terminal emulator installed.
3. Open the serial-terminal emulator, and adjust the settings to communicate with the UPS:
 - Select “Serial” connection for the session.
 - Check the computer “device management” settings for the communication port (for example COM6), and select it in the emulator.

- Select 115200 for the connection speed.
 - Open the emulator session.
4. On the CLI, enter the username and password:
- Default username = user
 - Default password = 123456
5. On the command line, enter update, then press d on the keyboard, see [Figure 5-7](#) on the next page
6. In the menu bar, select Files Transfer > Ymodem, select the MCU upgrade file, then click **Send**.

The status of the transfer displays in a status dialog. After about 3 minutes, the UPS restarts and the CLI exits update mode.

NOTE: The transfer process takes about 3 minutes. Do not close the status dialog.

- a. You can check the firmware version by entering status system in the command line.

Figure 5-7 File Transfer with the CLI

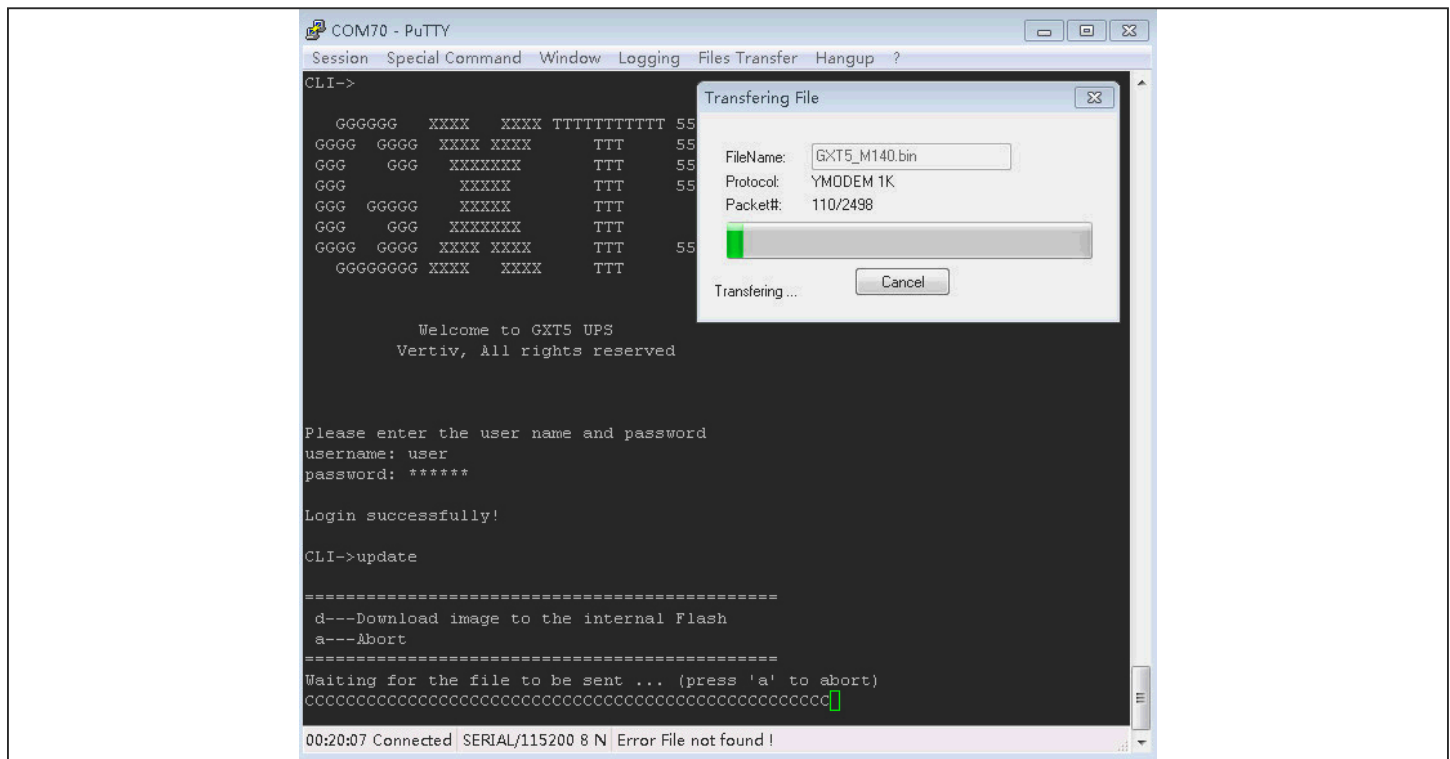

Updating DSP Firmware via CLI

NOTE: Only update the DSP firmware while the UPS is in Stand-by mode. The REPO terminal of the UPS must be un-plugged. Do not update firmware while the UPS is on Battery mode.

1. Disconnect the REPO terminal from the rear panel of the UPS, see [Figure 5-8](#) below.

Figure 5-8 REPO Terminal

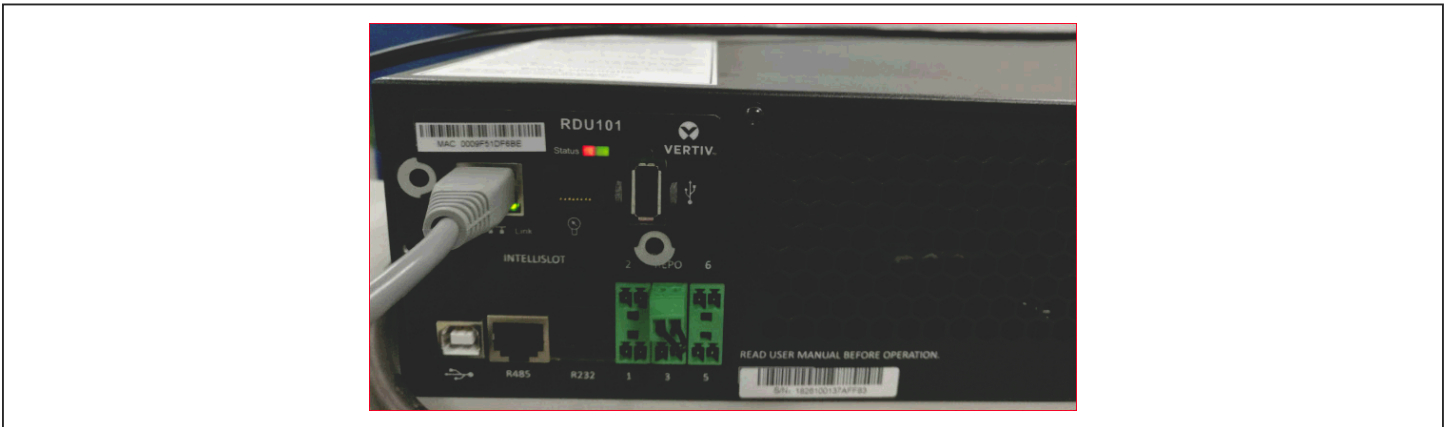

2. Connect the RJ-45 connector to the R232 port on UPS. For the connection location, refer to the appropriate rear-panel description for your UPS model in [Rear Panels](#) on [pages 4-6](#).
3. Connect the DB9 connector to a computer with the serial-terminal emulator installed.
4. Open the serial-terminal emulator, and adjust the settings to communicate with the UPS:
 - Select “Serial” connection for the session.
 - Check the computer “device management” settings for the communication port (for example COM6), and select the same port in the emulator.
 - Select 115200 for the connection speed.
 - Open the emulator session.
5. On the CLI, enter the username and password:
 - Default username = user
 - Default password = 123456
6. On the command line, enter update, then press d on the keyboard, see [Figure 5-9](#) on the next page
7. In the menu bar, select Files Transfer > Ymodem, select the MCU upgrade file, then click **Send**.

The status of the transfer displays in a status dialog. After about 2 minutes, the UPS restarts and the CLI exits update mode.

NOTE: The transfer process takes about 2 minutes. Do not close the status dialog.

- a. You can check the firmware version by entering status system in the command line.

Figure 5-9 File Transfer with the CLI

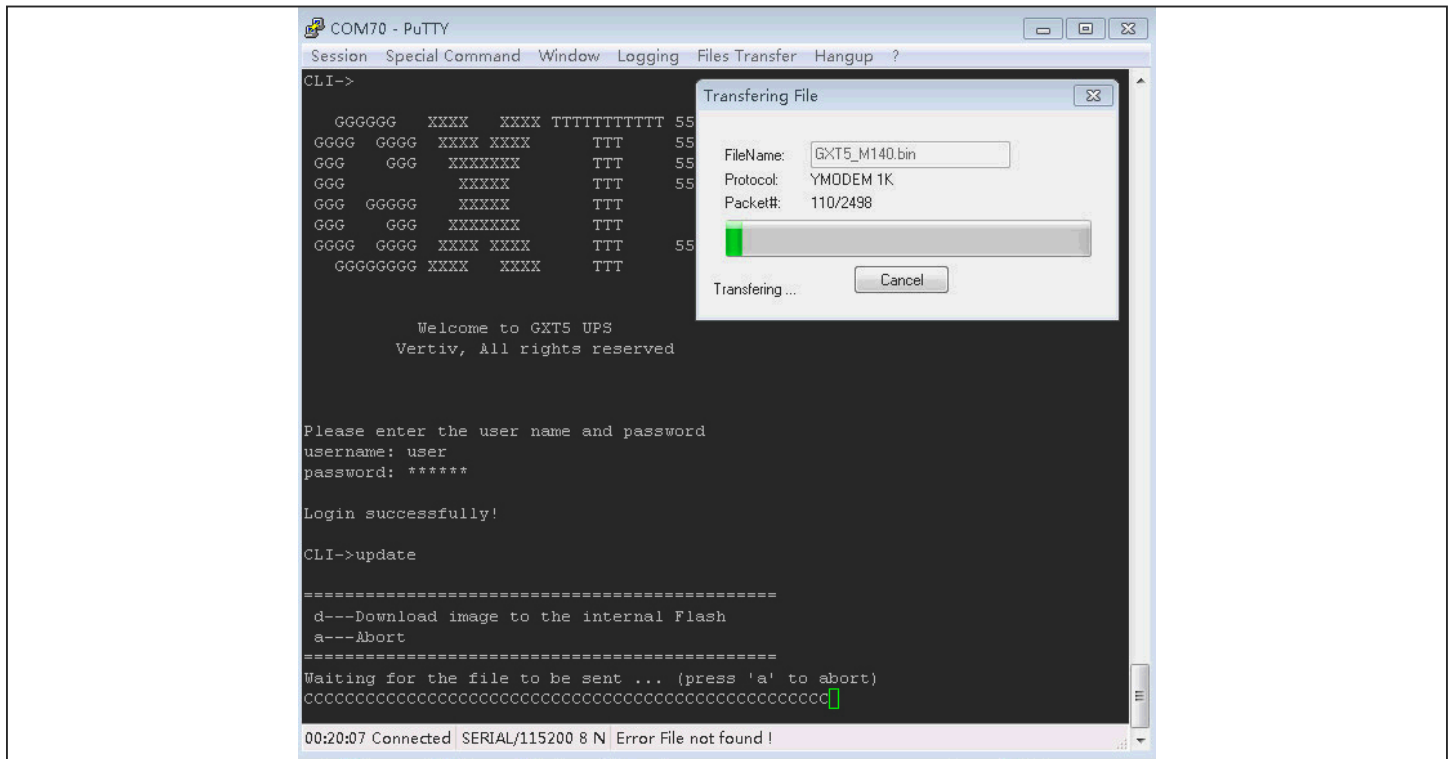

Chapter 6: Troubleshooting

This section indicates various UPS symptoms you may encounter and provides a troubleshooting guide in the event the UPS develops a problem. Use the following information to determine whether external factors caused the problem and how to remedy the situation.

6.1. Symptoms that Require Troubleshooting

The following symptoms indicate the UPS is malfunctioning:

- The relative indicators illuminate, indicating the UPS has detected a problem.
- An alarm buzzer sounds, alerting the user that the UPS requires attention.

6.2. Audible Alarm (Buzzer)

An audible alarm accompanies various events during UPS operations. [Table 6-1](#) below, describes the sounds and their meaning. To silence an alarm, see [Silencing the Audible Alarm](#) on [page 21](#).

Table 6-1 Audible-alarm Descriptions

SOUND	INDICATES
Continuous beep	Generated when a UPS fault appears, such as a fuse or hardware failure.
One beep every 0.5 seconds	Generated when a UPS critical alarm appears, such as on inverter overload.
One beep every 1 second	Generated when a UPS critical alarm appears, such as on battery low voltage.
One beep every 3.3 seconds	Generated when a UPS general alarm appears.

NOTE: When an alarm is indicated, an alarm message is logged. [Table 4-4](#) on [page 43](#), describes the alarm messages you may see. When a fault is indicated, front-panel display list the fault, which are described in [Table 6-2](#) below.

6.2.1. Faults

When the fault indicator is illuminated, the LCD displays the fault. The faults are described in [Table 6-2](#) below.

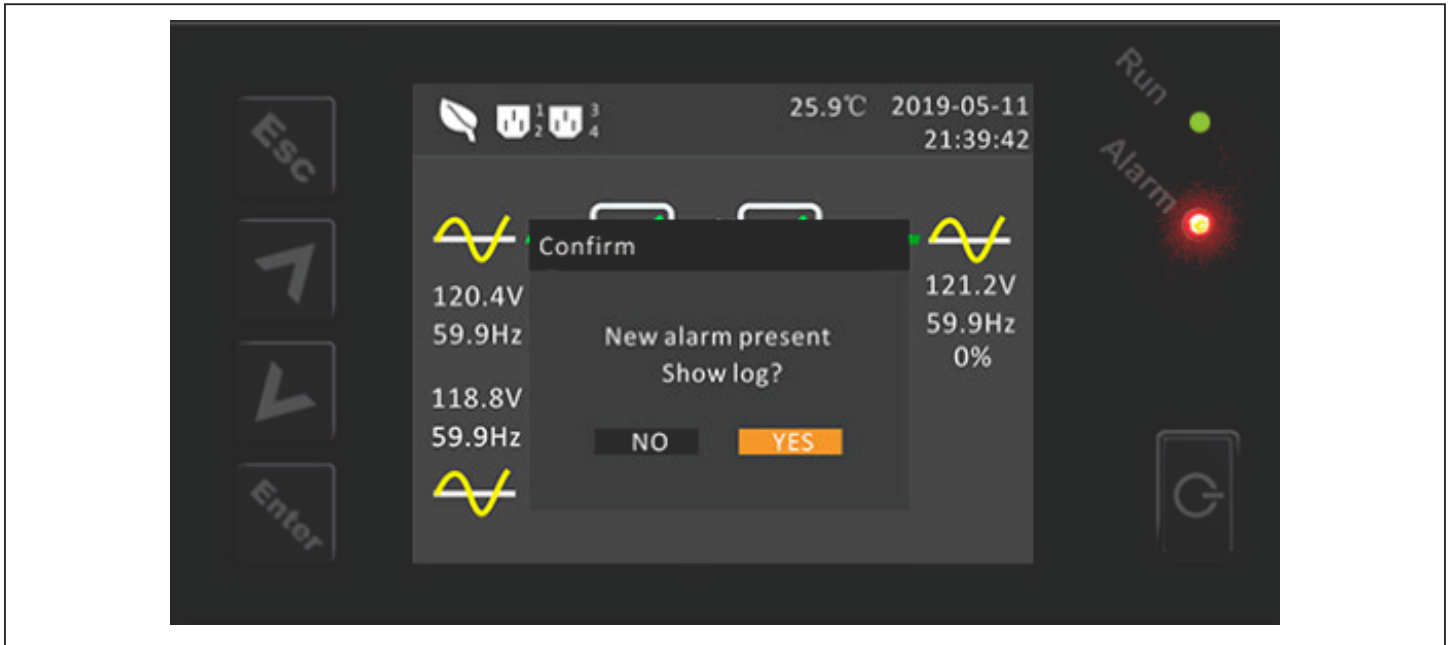

Table 6-2 Description of displayed faults

DISPLAYED FAULT	CAUSE	CORRECTIVE STEPS
Battery test fail	The battery is bad or weak.	Contact technical support.
Rectifier fault	A rectifier failure occurred.	Contact technical support.
Inverter overload, Bypass overcurrent	The UPS is overloaded, Bypass is over current.	Reduce the load and contact technical support.
Inverter fault	The inverter is faulty.	Contact technical support.
Battery aged	The battery is bad or weak.	Replace the battery.
Output short	The output connection is short-circuited.	Shut-down the equipment and contact technical support.
DC bus fail	The DC bus is faulty.	Contact technical support.
System overtemp	Over-temperature condition in the UPS. The UPS will transfer to bypass mode.	Reduce the load and contact technical support.
Charger fault	The charger is faulty.	Contact technical support.
Fan fault	At least one fan is faulty.	Contact technical support.
DC/DC fault	A DC-DC charger failure occurred.	Contact technical support.

6.3. Troubleshooting UPS Issues

In the event of an issue with the UPS, refer to Table 6.3 below, to determine the cause and solution. If the fault persists, contact Vertiv Technical Support. Visit the GXT5 product page at www.vertiv.com for contact information.

When reporting a UPS issue to Vertiv, include the UPS model and serial number. These are located in several places for your ease of location:

- On the top panel (rack mount orientation)
- The left side (tower orientation)
- The rear panel
- On the front of the unit behind the front plastic bezel
- On the LCD select *Main Menu > About*

Table 6-3 Troubleshooting

PROBLEM	CAUSE	SOLUTION
UPS fails to start	UPS is short-circuited or overloaded	Ensure UPS is Off. Disconnect all loads and ensure nothing is lodged in output receptacles. Ensure loads are not defective or shorted internally.
	Batteries are not charged enough or not connected	Check to ensure the internal battery is connected. If it is not, make the connection and try to start the unit. If the battery is connected, leave the UPS connected to input power for 24 hours to recharge batteries, then try to start the unit.
UPS has reduced battery backup time	Batteries are not fully charged	Keep UPS plugged in continuously at least 24 hours to recharge batteries.
	UPS is overloaded	Check load level indicator and reduce the load on the UPS.
	Batteries may not be able to hold a full charge due to age	Replace batteries. Contact your Vertiv representative or Vertiv Technical Support for replacement battery kit.

This page is intentionally left blank.

Chapter 7: Specifications

Table 7-1 UPS Specifications, 500 VA to 1000 VA models

MODEL GXT5-	500LVRT2UXL	750LVRT2UXL	1000LVRT2UXL(TAA)
RATING	500 VA/500 W	750 VA/750 W	1000 VA/1000 W
Dimensions, D×W×H, in. (mm)			
Unit	15.7 x 16.9 x 3.4 (400 x 430 x 85)		
Shipping	24.3 x 22.4 x 10.3 (617 x 570 x 262)		
Weight, lb.(kg)			
Unit	37 (16.8)		
Shipping	49.9 (22.68)		
Input AC			
Voltage Range (typical)	120 VAC nominal, variable based on output load		
90% ~ 100% loading	94 ~ 102 VAC/149.5 VAC		
70% ~ 90% loading	77 ~ 94 VAC/149.5 VAC		
50% ~ 70% loading	60 ~ 77 VAC/149.5 VAC		
0% ~ 50% loading	60 VAC/149.5 VAC		
Frequency	40 Hz ~ 70 Hz; auto-sensing		
Input Power Cord	10-ft. (3 m) attached with NEMA 5-15P plug		
Output AC			
Output Receptacles	5-15R x 6		
Voltage	100/110/115/120/125 VAC (user-configurable); ±3%		
Waveform	Sine wave		
Normal Mode Overload	> 200% for 250 mS 150 - 200% for 2 seconds 125 - 150% for for 60 seconds		
Battery Parameters			
Type	Valve-regulated, non-spillable, lead acid		
Quantity x Voltage x Rating	3 x 12V x 9.0AH		
Battery Mfr./Part #	LEOCH DJW12-9.0		
Back-up time	See Battery Run Times on page 70 .		
Recharge time	3 hours to 90% capacity		
Environmental			
Operating Temperature, °F (°C)	32 to 122 (0 to 50)		
Storage Temperature, °F (°C)	-4 to 140 (-20 to 60) [batteries are from 5 to 104 (-15 to 40)]		
Relative Humidity	0% - 95% non-condensing		
Operating Elevation	Up to 10,000 ft (3,000 m) at 77°F (25°C) without derating		
Audible Noise	<46 dBA max. at 3 ft (1 m) front and sides, <43 dBA max. at 3 ft (1 m) rear		
Agency			
Surge Immunity	IEEE/ANSI C62.41 Category B (6kV/3kA)		
Transportation	ISTA Procedure 1A		

Table 7-2 UPS Specifications, 1500 VA to 3000 VA models

MODEL GXT5-	1500LVRT2UXL(TAA)	2000LVRT2UXL(TAA)	3000LVRT2UXL(TAA)
RATING	1500 VA/ 1350 W	2000 VA/ 1800 W	3000 VA/ 2700 W
Dimensions, D×W×H, in. (mm)			
Unit	18.5 x 16.9 x 3.4 (470 x 430 x 85)		21.3 x 16.9 x 3.4 (540 x 430 x 85)
Shipping	24.3 x 22.4 x 10.3 (617 x 570 x 262)		28.2 x 22.4 x 10.3 (717 x 570 x 262)
Weight, lb.(kg)			
Unit	46.2 (21)	47.5 (21.6)	66 (30)
Shipping	57.4 (26.1)	58.7 (26.7)	77.2 (35.1)
Input AC			
Voltage Range (typical)	120 VAC nominal, variable based on output load		
90% ~ 100% loading	94 ~ 102 VAC/149.5 VAC		
70% ~ 90% loading	77 ~ 94 VAC/149.5 VAC		
50% ~ 70% loading	60 ~ 77 VAC/149.5 VAC		
0% ~ 50% loading	60 VAC/149.5 VAC		
Frequency	40 Hz ~ 70 Hz; auto-sensing		
Input Power Cord	10-ft. (3 m) attached with NEMA 5-15P plug	10-ft. (3 m) attached with NEMA L5-20P plug	10-ft. (3 m) attached with NEMA L5-30P plug
Output AC			
Output Receptacles	5-15R x 6	L5-20R + 5-15/20R x 6	L5-30R + 5-15/20R x 6
Voltage	100/110/115/120/125 VAC (user-configurable); ±3%		
Waveform	Sine wave		
Normal Mode Overload	> 200% for 250 mS 150 – 200% for 2 seconds 125 – 150% for for 50 seconds 105 – 125% for 60 seconds		> 200% for 250 mS 150 – 200% for 2 seconds 125 – 150% for for 10 seconds 105 – 125% for 15 seconds
Battery Parameters			
Type	Valve-regulated, non-spillable, lead acid		
Quantity x Voltage x Rating	4 x 12V x 9.0AH		6 x 12V x 9.0AH
Battery Mfr./Part #	LEOCH DJW12-9.0		
Back-up time	See Battery Run Times on page 70 .		
Recharge time	4 hours to 90% capacity after full discharge with 100% load till UPS auto-shutdown (internal batteries only)		3 hours to 90% capacity after full discharge with 100% load til UPS auto-shutdown (internal batteries only)
Environmental			
Operating Temperature, °F (°C)	32 to 122 (0 to 50)		
Storage Temperature, °F (°C)	-4 to 140 (-20 to 60) [batteries are from 5 to 104 (-15 to 40)]		
Relative Humidity	0% – 95% non-condensing		
Operating Elevation	Up to 10,000 ft (3,000 m) at 77°F (25°C) without derating		
Audible Noise	<46 dBA max. at 3 ft (1 m) front and sides, <45 dBA max. at 3 ft (1 m) rear	<46 dBA max. at 3 ft (1 m) front and sides, <48 dBA max. at 3 ft (1 m) rear	
Agency			
Surge Immunity	IEEE/ANSI C62.41 Category B (6kV/3kA)		
Transportation	ISTA Procedure 1A		

Table 7-3 External Battery Cabinet Specifications

MODEL NUMBER	GXT5-EBC36VRT2U(TAA)	GXT5-EBC48VRT2U(TAA)	GXT5-EBC72VRT2U(TAA)
USED W/UPS MODEL	500 – 1000 VA MODELS	1500 – 2000 VA MODELS	3000 VA MODELS
Dimensions, D×W×H, in. (mm)			
Unit	14.6 x 16.9 x 3.3 (370 x 430 x 85)	17.3 x 16.9 x 3.4 (440 x 430 x 85)	20.1 x 16.9 x 3.4 (510 x 430 x 85)
Shipping	24.3 x 22.4 x 10.3 (617 x 570 x 262)		28.2 x 22.4 x 10.3 (717 x 570 x 262)
Weight, lb.(Kg)			
Unit	49.72 (22.6)	63.36 (28.8)	90.64 (41.2)
Shipping	63.14 (28.7)	77 (35)	104.72 (47.6)
Battery			
Type	Valve-regulated, non-spillable, lead acid		
Configuration	Two parallel strings of three 12V/9Ah batteries in series.	Two parallel strings of four 12V/9Ah batteries in series.	Two parallel strings of six 12V/9Ah batteries in series.
Battery Mfr./Part#	LEOCH DJW12-9.0		
Backup time	See Battery Run Times on page 70 .		
Environmental Requirements			
Operating Temperature, °F (°C)	32 to 104 (0 to 40)		
Storage Temperature, °F (°C)	5 to 122 (-15 to 50)		
Relative Humidity	0% to 95%, non-condensing		
Operating Elevation	Up to 10,000 ft (3,000 m) at 104 °F (40 °C)		
Storage Elevation	50,000 ft (15,000 m) maximum		
Agency			
Safety	UL1778 4th Edition and CSA 22.2 No. 107.1		
RFI/EMI	FCC Part 15 Class A		
Surge Immunity	ANSI C62.41 Category B		
Transportation	ISTA Procedure 1A		

7.1. Battery Run Times

Table 7-4 Battery Run Time in Minutes, GXT5-500LVRT2UXL

LOAD			INTERNAL BATTERY ONLY	NUMBER OF EXTERNAL BATTERY CABINETS									
				1	2	3	4	5	6	7	8	9	10
%	VA	W											
10	50	50	190.6	625.3	1105.6	1543.7	1820.7	1996.9	2118.9	2208.4	2276.8	2330.9	2374.6
20	100	100	103.5	338.1	593.7	854.4	1132	1392.2	1607.3	1765	1885.6	1980.8	2057.8
30	150	150	70.1	234.1	410.9	595.3	778.7	975.1	1175.6	1359.5	1527	1659.9	1767.5
40	200	200	50.7	181.5	314.7	457.2	600.8	743.3	896.1	1051.8	1209.1	1351.2	1487
50	250	250	40.4	147.8	255.6	369.9	487.9	607.1	724.8	850.9	978.9	1108.5	1235.7
60	300	300	33.2	125.4	215.6	312.4	411.9	513.7	614.5	716.3	824.2	933.3	1044.1
70	350	350	27.6	109.4	189.4	270.4	357	447.2	535.7	622.2	713.3	807.7	903.5
80	400	400	23.7	95.5	168.4	238.6	315.4	393	473.2	553.6	628.4	711.4	795.8
90	450	450	20.4	84.9	149.1	212.7	281	350.4	420.8	493.1	565.9	632.4	707.6
100	500	500	17.9	76.3	135.1	193.1	251.9	314.1	377.5	443.2	507	573.3	632.8

Table 7-5 Battery Run Time in Minutes, GXT5-750LVRT2UXL

LOAD			INTERNAL BATTERY ONLY	NUMBER OF EXTERNAL BATTERY CABINETS									
				1	2	3	4	5	6	7	8	9	10
%	VA	W											
10	75	75	135.3	443.8	770.4	1122.8	1451.4	1694.8	1863.3	1986.9	2081.4	2155.9	2216.3
20	150	150	69.7	233.2	409.2	592.9	775.6	971	1170.6	1354.3	1522.2	1655.7	1763.7
30	225	225	44.3	164.6	283.3	410.2	540.7	667.8	805.1	945.1	1087.1	1227.9	1357.2
40	300	300	33.4	126.3	217	314.3	414.3	516.9	617.5	720.7	829.3	939.2	1050.4
50	375	375	25.5	102.4	177.8	254.1	334.6	417.4	502.1	588	667.7	756.2	845.8
60	450	450	20.3	84.7	148.7	211.9	280	349.2	419.3	491.4	564	630.1	705.1
70	525	525	16.8	72.3	128.6	184.4	239.6	299	359.5	421.1	483.6	546.8	608.7
80	600	600	14.3	60.1	112.8	162.6	209.7	262.2	315.3	368.9	423.4	478.5	534.4
90	675	675	12.1	53.1	99.8	144.3	188.9	232.7	279.6	327	375.7	424.7	474.4
100	750	750	10.4	45.4	87.3	128.3	168.7	206.6	248	290.4	332.9	376.7	420.1

Table 7-6 Battery Run Time in Minutes, GXT5-1000LVRT2UXL and GXT5-1000LVRT2UXLTAA

LOAD			INTERNAL BATTERY ONLY	NUMBER OF EXTERNAL BATTERY CABINETS									
				1	2	3	4	5	6	7	8	9	10
%	VA	W											
10	100	100	103.1	337	591.9	851.7	1128.5	1388.3	1603.9	1762.1	1883	1978.5	2055.8
20	200	200	50.9	182	315.6	458.5	602.3	745.4	898.7	1054.9	1212.3	1354.8	1490.4
30	300	300	33.4	126.1	216.7	313.9	413.8	516.2	616.9	719.6	828.2	937.9	1049
40	400	400	23.7	95.1	167.9	238	314.5	391.8	471.9	552.0	627	709.3	793.4
50	500	500	17.9	76.5	135.5	193.6	252.7	315	378.6	444.5	508.4	575	634.7
60	600	600	14.2	60	112.6	162.3	209.4	261.8	314.7	368.2	422.6	477.7	533.5
70	700	700	11.5	50.4	94.7	138.7	180.8	223	267.4	313.5	359.3	406.7	455.4
80	800	800	9.5	42.8	82.4	119.2	157.8	195.2	232.3	271.3	312	352.5	393.4
90	900	900	8	37.8	72.1	106.3	139.7	173.3	205.2	239.0	274.7	310.8	347
100	1000	1000	6.7	32.6	61.5	92.9	123.7	154	184.4	212.9	244.4	276.4	308.7

Table 7-7 Battery Run Time in Minutes, GXT5-1500LVRT2UXL and GXT5-1500LVRT2UXLTAA

LOAD			INTERNAL BATTERY ONLY	NUMBER OF EXTERNAL BATTERY CABINETS									
				1	2	3	4	5	6	7	8	9	10
%	VA	W											
10	150	135	118.9	391.9	681.7	993.4	1303.4	1568.4	1756.4	1894.2	1999.6	2082.8	2150.1
20	300	270	58	203.3	355	514.4	671.8	840.7	1013.8	1190.0	1349.7	1500.1	1623
30	450	405	37	137.4	235.1	340.7	450.8	560.6	666.8	782.5	900.1	1019.5	1140.5
40	600	540	25.2	101.6	176.7	252.4	332.2	414.7	498.7	583.9	662.9	750.7	839.8
50	750	675	18.8	79.7	140.6	200.5	262.5	327.1	393.3	462.0	529	597.8	660.2
60	900	810	14.7	62.4	115.2	166.6	215.2	268.1	322.7	377.9	434.6	490.3	547.4
70	1050	945	11.7	51.3	96.3	140.4	183.3	226	270.7	317.7	364.2	411.9	461.3
80	1200	1080	9.5	42.9	82.6	119.5	158.2	195.7	232.8	272.0	312.8	353.4	394.4
90	1350	1215	7.9	37.7	71.8	105.9	139.3	172.7	204.6	238.3	273.7	309.7	345.9
100	1500	1350	6.7	32.4	61	92.3	123	153.1	183.5	211.6	243.1	274.9	307.1

Table 7-8 Battery Run Time in Minutes, GXT5-2000LVRT2UXL and GXT5-2000LVRT2UXLTA

LOAD			INTERNAL BATTERY ONLY	NUMBER OF EXTERNAL BATTERY CABINETS									
				1	2	3	4	5	6	7	8	9	10
%	VA	W											
10	200	180	80.3	264.4	465.3	665.4	881.7	1103.7	1316.1	1508.5	1659.3	1778.3	1874.7
20	400	360	38.7	142.6	244.8	354.7	468.8	584	694.8	815.6	938.3	1062.8	1188.8
30	600	540	23.9	96	169.2	239.7	317	395.1	475.3	556.4	631.1	714.9	799.8
40	800	720	16.6	71.2	126.9	182	236.9	295.5	355.3	415.9	477.6	539.7	602.3
50	1000	900	12.3	53.6	100.7	145.3	190.3	234.4	281.9	329.4	378.7	428.4	477.8
60	1200	1080	9.5	42.8	82.4	119.3	157.8	195.3	232.4	271.4	312.1	352.7	393.6
70	1400	1260	7.5	36.1	68.7	102	134.6	167	198.5	230.6	264.3	298.4	333.3
80	1600	1440	6	29.6	57	86.9	115.9	144.4	173.1	200.6	228.9	258.5	288.6
90	1800	1620	4.9	25.3	49	76.7	102	126.9	151.4	177.3	201.8	227	253.3
100	2000	1800	4	22	42.8	66.3	88.7	112.8	135.6	157.8	179.9	202.1	224.6

Table 7-9 Battery Run Time in Minutes, GXT5-3000LVRT2UXL and GXT5-3000LVRT2UXLTA

LOAD			INTERNAL BATTERY ONLY	NUMBER OF EXTERNAL BATTERY CABINETS									
				1	2	3	4	5	6	7	8	9	10
%	VA	W											
10	300	270	85.5	283.3	497.2	713.4	945.2	1183.3	1400.5	1585.7	1727.4	1839.3	1929.8
20	600	540	40.9	149.3	258.6	374.4	493.8	613.1	733.8	861.2	990.5	1122.1	1249.2
30	900	810	24.7	99.8	174.3	248.2	327	408.3	490.8	574.5	652.4	738.9	826.5
40	1200	1080	17	73	129.7	185.9	241.6	301.4	362.5	424.8	487.5	551.2	612.6
50	1500	1350	12.6	54.6	102.6	147.4	193.4	238.1	286.8	335.3	384.9	436.3	485.9
60	1800	1620	9.7	43.4	83.6	121.2	160.5	198.1	235.8	276.1	317.1	358	400.1
70	2100	1890	7.7	36.7	69.8	103.4	136.3	169.1	200.7	233.4	267.5	302.4	337.9
80	2400	2160	6.1	29.9	57.5	87.5	116.7	145.5	174.6	202.1	230.8	260.8	291.1
90	2700	2430	4.9	25.6	49.5	77.3	102.8	127.9	152.6	178.4	203	228.6	255.1
100	3000	2700	4	22.2	43.1	67.1	89.3	113.7	136.8	159.3	181.6	203.6	226.6

Appendix I: Open Source Software Legal Notices

The GXT5 product links the FreeRTOS software with Vertiv Group Corporation's proprietary modules that communicate with the FreeRTOS software solely through the FreeRTOS API interface. This use is an exception to the FOSS GPLv2 license. The user is free to redistribute the FreeRTOS software and/or modify it under the terms of the GNU General Public License as published by the Free Software Foundation. A copy of the GNU General Public License is located at www.gnu.org/licenses/old-licenses/gpl-2.0.html. A copy of the exception is located at <https://spdx.org/licenses/freertos-exception-2.0.html>. For a period of three (3) years after purchasing the GXT5 product, the purchaser has the right to obtain a copy of the FreeRTOS software that is incorporated in the GXT5 product. The purchaser can contact Vertiv Technical Support and request the software.

This page is intentionally left blank.

Appendix II: Technical Support

Our Technical Support staff is ready to assist you with any installation or operating issues you may encounter with your Liebert® product. Please call or e-mail us:

In Europe, Middle East, and Asia

EMEA Multi-Language Technical support

e: eoc@vertiv.com
p: Toll free 0080011554499
p: Toll +39 02 98250222

In the United States

Technical support

e: liebert.upstech@vertiv.com
p: 1-800-222-5877 menu option 1

Monitoring support

e: liebert.monitoring@vertiv.com
p: 1-800-222-5877 menu option 2

Warranty support

e: microups.warranty@vertiv.com
p: 1-800-222-5877 menu option 3

This page is intentionally left blank.

