

SYSTEM OVERVIEW

Description: -48 VDC to -58 VDC @ up to 600 Amperes Converter System

The Vertiv™ NetSure™ DCS48/58-600 Converter System is a complete integrated converter system containing -48 VDC to -58 VDC converters, intelligent control, metering, monitoring, and distribution. The converter system is designed for operation with the positive output grounded.

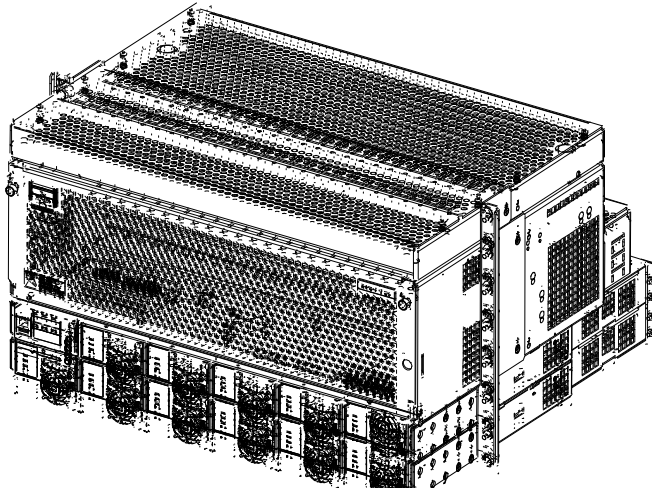

This system consists of the following components.

- **DC Distribution Cabinet**

The base system includes one (1) distribution cabinet, which provides DC distribution through fuses and/or circuit breakers. The distribution cabinet can be equipped either with a 1-row, 26-position bullet nose type circuit breaker and TPS/TLS fuseholder distribution panel or a distribution panel equipped with four (4) GJ/218 type circuit breaker positions. The distribution cabinet may be equipped with a load disconnect contactor.

A field installed only expansion distribution cabinet is available which provides DC distribution through fuses and/or circuit breakers. The expansion distribution cabinet is equipped with a 1-row, 26-position bullet nose type circuit breaker and TPS/TLS fuseholder distribution panel. The expansion distribution cabinet may be equipped with a load disconnect contactor.

- **Controller**

NCU (NetSure™ Control Unit) Controller: The NCU controller provides power system control, converter module control, metering functions, monitoring functions, local/remote alarm functions, and connections for binary inputs and programmable relay outputs. The system also accepts up to two (2) temperature probes to monitor ambient and/or battery temperature. The controller also provides data acquisition and system alarm management. The controller contains a color TFT display and keypad for local access. The controller provides an Ethernet port and comes with comprehensive webpages for local/remote access. The controller has SNMP V3 capability for remote system management. The controller supports software upgrade via its USB port. Refer to the NCU Controller Instructions (UM1M830BNA) for more information.

- **Converter Module Mounting Shelf (Spec. No. 588705300)**

The system contains two (2) Spec. No. 588705300 converter module mounting shelves, each of which houses the converter modules. The top converter module mounting shelf also houses the NCU controller.

A field installed only expansion converter module mounting shelf is available. Up to two (2) expansion converter module mounting shelves can be installed in an existing system.

- **-48 VDC to -58 VDC Converter Modules**

The system accepts 2000 watt peak, 1600 watt average converter modules to provide -58 VDC load power. Refer to the Converter Instructions (UM1C48582000P3) for more information.

Vertiv™ NetSure™ DCS48/58-600 Converter System

System Application Guide

General Converter Systems Specifications

See detailed specifications on page 42.

Family:	NetSure™
Spec. No.:	584641000
Model:	DCS48/58-600
DC Input Voltage:	Nominal -48 VDC (-41 VDC to -58.5 VDC).
DC Output Voltage:	Nominal -57 VDC, positive ground. Output voltage is adjustable from -56.0 VDC to -58.0 VDC via the system controller.
DC Output Capacity:	600 A, maximum
1C48582000P3 Converter Rating:	See UM1C48582000P3.
Agency Approval:	UL Listed to UL/CSA 62368-1 (cULus), Meets NEBS Level 1
Mounting Type:	Nominal 23" Relay Rack or Equipment Rack Mounting
Mounting Depth:	See "Overall Dimensions" on page 44.
Mounting Height:	See "Overall Dimensions" on page 44.
Access:	Front and Rear for Installation, Expansion, and Maintenance. Front for Operation.
Control:	Microprocessor
Color:	Faceplates: Textured Gray Other Surfaces: Bright Zinc
Environment:	-40 °C to +65 °C (-40 °F to +149 °F)

Vertiv™ NetSure™ DCS48/58-600 Converter System

System Application Guide

TABLE OF CONTENTS

SYSTEM OVERVIEW.....	1
MAIN COMPONENTS ILLUSTRATIONS.....	5
58464100001 and 58464100002.....	5
58464100003 and 58464100004.....	6
LIST DESCRIPTIONS.....	7
List Numbers.....	7
584641000 List 01: -48 VDC to -58 VDC Converter System, 23" Rack Mounted, 400 A Maximum, Twenty-Six (26) Bullet Nose Type Distribution Positions, Without Load Disconnect Contactor.....	7
584641000 List 02: -48 VDC to -58 VDC Converter System, 23" Rack Mounted, 400 A Maximum, Twenty-Six (26) Bullet Nose Type Distribution Positions, With Load Disconnect Contactor.....	8
584641000 List 03: -48 VDC to -58 VDC Converter System, 23" Rack Mounted, 600 A Maximum, Four (4) GJ/218 Type Circuit Breaker Positions, Without Load Disconnect Contactor.....	9
584641000 List 04: -48 VDC to -58 VDC Converter System, 23" Rack Mounted, 600 A Maximum, Four (4) GJ/218 Type Circuit Breaker Positions, With Load Disconnect Contactor.....	10
584641000 List 10: Field Installed Expansion Converter Module Mounting Shelf.....	11
584641000 List AL: Field Installed DC Distribution Cabinet, Twenty-Six (26) Bullet Nose Type Distribution Positions, Without Load Disconnect Contactor.....	11
584641000 List CL: Field Installed DC Distribution Cabinet, Twenty-Six (26) Bullet Nose Type Distribution Positions, With Load Disconnect Contactor.....	11
ACCESSORY DESCRIPTIONS.....	12
Controller.....	12
NCU (NetSure™ Control Unit) Controller, P/N 1M830BNA.....	12
Optional Temperature Probes.....	13
Optional SM-Temp Temperature Concentrator.....	14
SM-Temp Temperature Concentrator, P/N 547490.....	14
SM-Temp Jumpers, P/N 552888.....	14
Converter.....	14
-48 VDC to -58 VDC Converter Module, P/N 1C48582000P3.....	14
Module Mounting Position Blank Cover Panel.....	14
Module Mounting Position Blank Cover Panel, P/N SXA 110 0035/1.....	14
Field Installed Load Disconnect Contactor Kit, P/N 60082562.....	15
Field Installed Load Disconnect Contactor Remote Driver Jumper, P/N 60067965.....	15
Distribution Devices.....	15
Bullet Nose Type Circuit Breakers and Bullet Nose Type Fuseholders e/w TPS/TLS Fuses.....	15
Optional Bullet Nose Type 6-Position GMT Distribution Fuse Block, P/N 549017, (6) GMT Fuse Positions.....	19
GMT Type Load Distribution Fuses.....	20
GJ/218 Type Circuit Breakers.....	21
Crimp Lugs and Busbar Adapter Kits.....	22
Standard Crimp Lugs (Two-Hole, 1/4" Bolt Clearance Hole, 5/8" Centers).....	22
Standard Crimp Lugs (Two-Hole, 3/8" Bolt Clearance Hole, 1" Centers).....	23
Busbar Lug Adapter Kits.....	24
Vertiv™ NetSure™ Power System Interface Kit, P/N 10064868.....	24
User Replaceable Alarm Fuses.....	25
User Replaceable Components.....	25
RECOMMENDED WIRE SIZES, BRANCH CIRCUIT PROTECTION, CRIMP LUGS, AND WIRING ILLUSTRATIONS.....	27
System Shelf Frame Grounding Connection.....	27
Central Office Ground Connection.....	28
SPD (Surge Protection Device) Earth Ground Connection.....	29
-48 VDC Input Connections to Factory and Field Installed Converter Module Mounting Shelves.....	30
Description.....	30
Converter Shelf Recommended DC Input Branch Circuit Protection, Wire Size, and Lug.....	30
-48 VDC Input Connections.....	31
-58 VDC Load Distribution Connections to Factory and Field Installed DC Distribution Cabinets.....	32
Load Distribution Wire Sizes and Lugs Selection.....	32
Wire Size and Lug Selection Tables for Load Connections to TPS/TLS Fuses and Bullet Nose Type Circuit Breakers.....	33

Vertiv™ NetSure™ DCS48/58-600 Converter System

System Application Guide

Wire Size and Lug Selection Tables for Load Connections to GJ/218 Type Circuit Breakers and TPS/TLS Fuses and Bullet Nose Type Circuit Breakers when Used with Load Lug Adapters P/N 559804 and 559805.....	34
-58 VDC Load Distribution Connections to TPS/TLS Fuses and Bullet Nose Type Circuit Breaker Positions	35
-58 VDC Load Distribution Connections to GJ/218 Circuit Breaker Positions	36
Load Distribution Wiring (Optional Bullet Nose 6-Position GMT Fuse Block).....	37
External Alarm, Reference, Monitoring, and Control Connections	38
General.....	38
External Alarm, Reference, Monitoring, and Control Connections Locations.....	38
IB2 (Controller Interface Board)	39
System Interface Board.....	40
NCU Controller Ethernet Connection.....	41
NCU Front Panel Ethernet Port.....	41
IB4 Board Ethernet Port.....	41
SPECIFICATIONS	42
1. System	42
1.1 Output Ratings.....	42
1.2 Input Ratings.....	42
1.3 Environmental Ratings	42
1.4 Compliance Information.....	43
1.5 IB2 (Controller Interface Board) Ratings.....	43
2. -48 VDC TO -58 VDC Converter	43
2.1 Refer to the Converter Instructions (UM1C4858200P3).....	43
3. Controller.....	43
3.1 Refer to the NCU Controller Instructions (UM1M830BNA).....	43
3.2 For controller factory settings, refer to the Controller Configuration Drawing (C-drawing).....	43
MECHANICAL SPECIFICATIONS.....	44
Overall Dimensions.....	44
584641000 List 01, List 02, List 03, List 04.....	44
584641000 List 01, List 02, List 03, List 04 (with Expansion DC Distribution Cabinet).....	45
584641000 List 10.....	46
584641000 List AL and List CL.....	47
Weights.....	48
RELATED DOCUMENTATION.....	48

MAIN COMPONENTS ILLUSTRATIONS
5846410001 and 5846410002

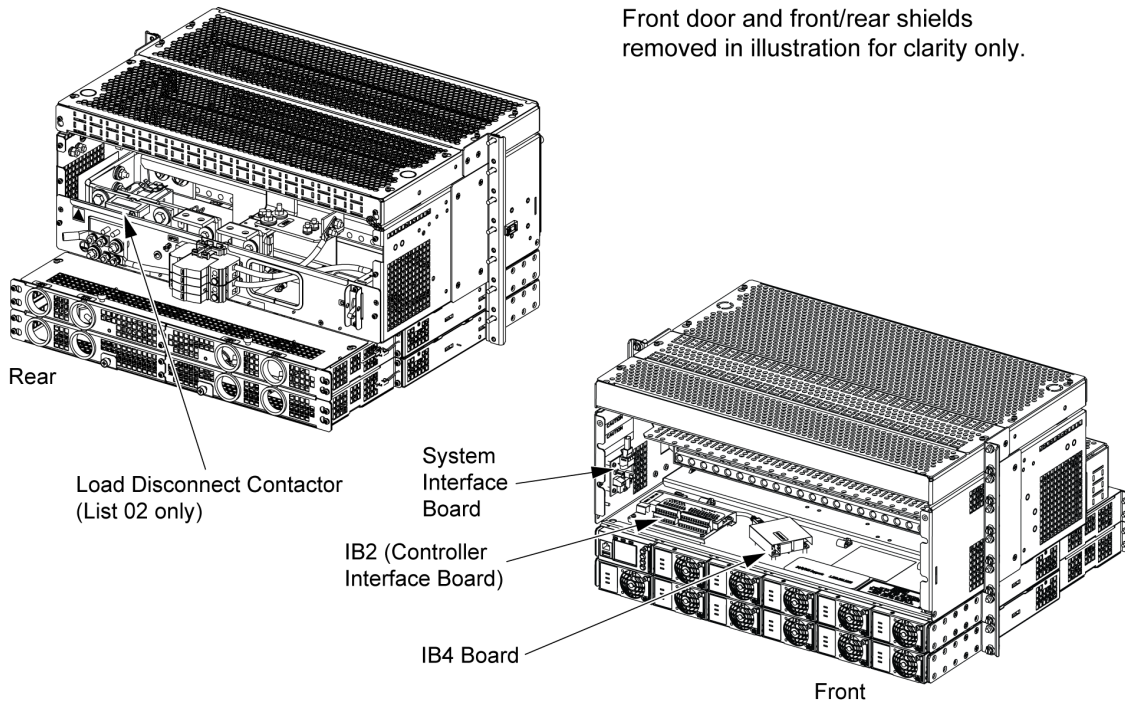
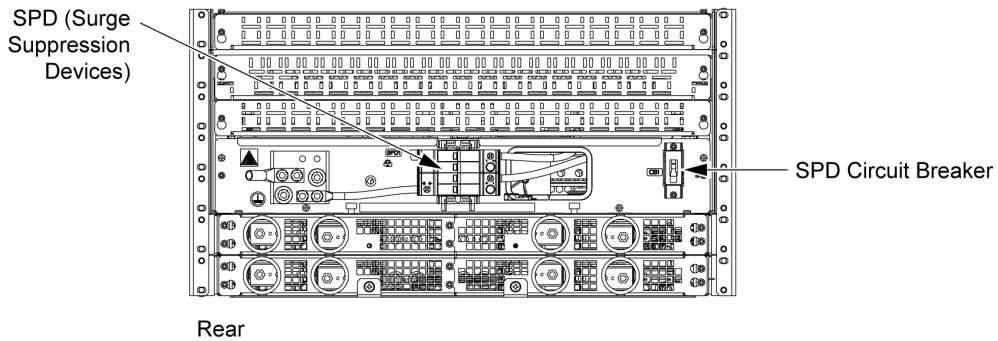
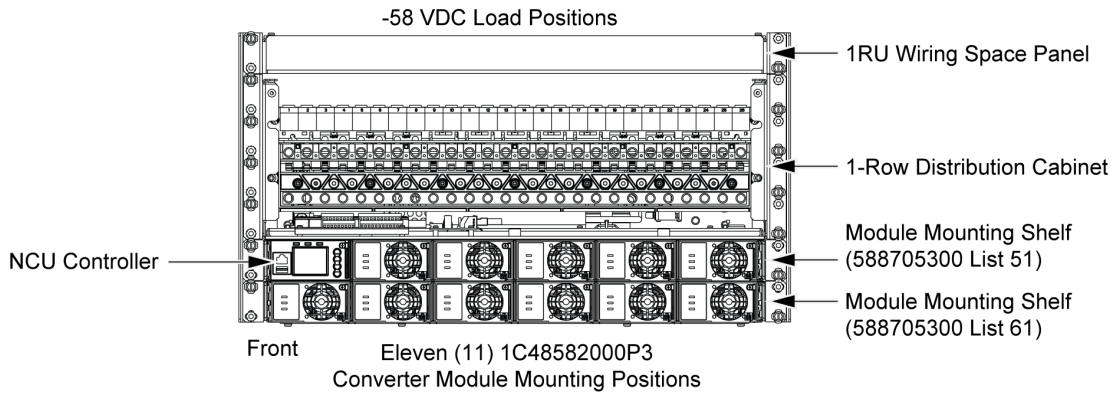

Vertiv™ NetSure™ DCS48/58-600 Converter System

System Application Guide

5846410003 and 5846410004

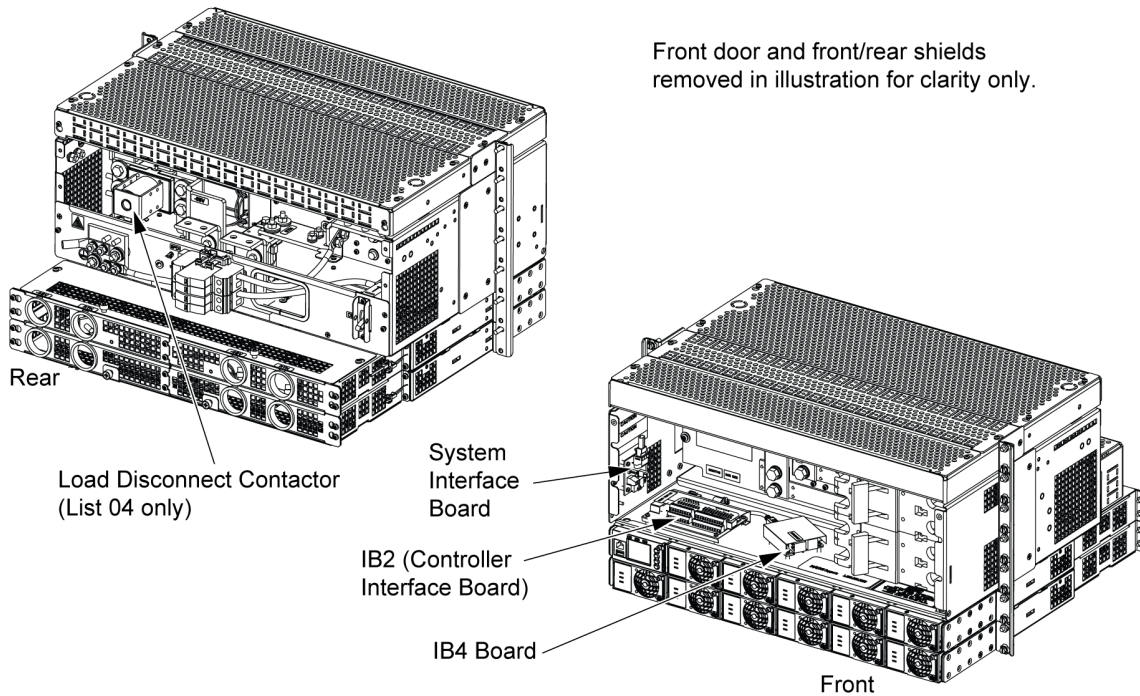
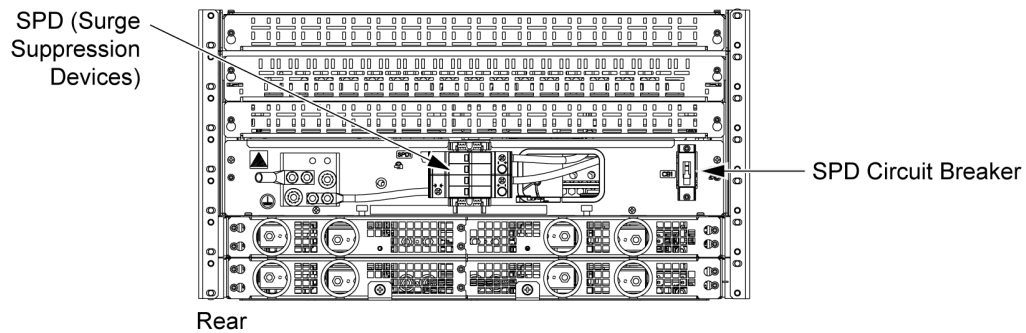
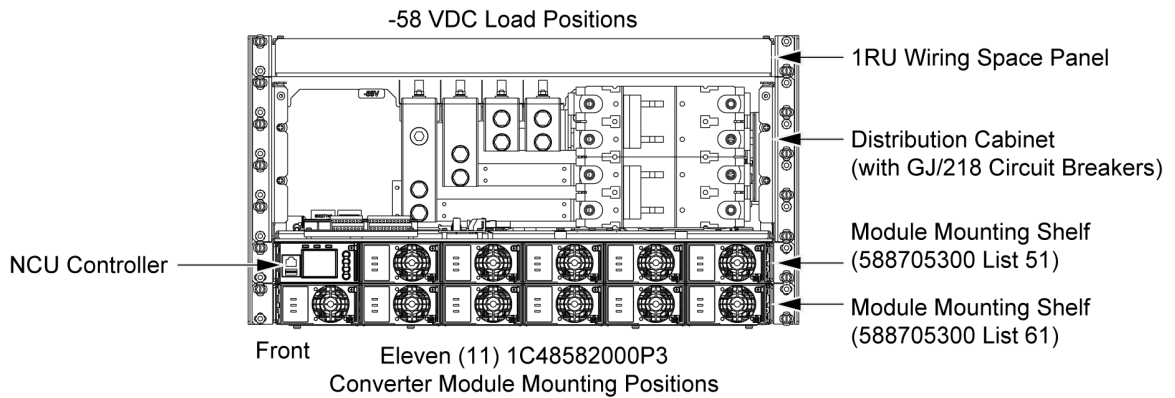

LIST DESCRIPTIONS

List Numbers

584641000 List 01: -48 VDC to -58 VDC Converter System, 23" Rack Mounted, 400 A Maximum, Twenty-Six (26) Bullet Nose Type Distribution Positions, Without Load Disconnect Contactor

Features

Provides a converter system consisting of the following factory packaged components.

- ◆ One (1) DC distribution cabinet with 1-row twenty-six (26) bullet nose type distribution positions.
- ◆ One (1) 5-position converter module mounting shelf with controller mounting slot.
- ◆ One (1) 6-position converter module mounting shelf.
- ◆ One (1) 1RU wiring space panel.
- ◆ Accepts one (1) NCU controller.
- ◆ Includes the IB4 board (provides a network connection point for NCU remote access).
- ◆ Includes the IB2 controller interface board (provides eight (8) programmable form C- relay outputs, eight (8) programmable binary inputs, and two (2) temperature inputs).
- ◆ Includes a system interface board.
- ◆ Includes factory installed SPD (Surge Protection Device) factory wired to the -58 VDC output. A circuit breaker is provided to remove power from the SPD device for maintenance.
- ◆ Accepts up to two (2) field installed expansion converter module mounting shelves.
- ◆ Accepts one (1) field installed expansion DC distribution cabinet.
- ◆ Includes an SPD earth ground lug. See “SPD (Surge Protection Device) Earth Ground Connection” on page 29.

Restrictions

Mounts in a 23" wide relay rack or equipment rack.

Up to two (2) expansion converter module mounting shelves can be added to a List 01, field installed only.

One (1) expansion DC distribution cabinet can be added to a List 01, field installed only.

Ordering Notes

- 1) Order one (1) NCU Controller P/N 1M830BNA (see page 12).
Also specify appropriate configuration file for your site.
- 2) Order converter modules P/N 1C48582000P3 quantity as needed per system (see page 14).
- 3) Order a converter mounting position blank cover panel P/N SXA1100035/1 for each empty converter mounting position in the system as desired (see page 14).
- 4) Order optional temperature probes for ambient and battery temperature monitoring as required. Refer to “Optional Temperature Probes” on page 13.
- 5) Order distribution fuses and/or circuit breakers as required per “Distribution Devices” starting on page 15.
- 6) Order 6-position GMT fuse block P/N 549017 and fuses as required per “Optional Bullet Nose Type 6-Position GMT Distribution Fuse Block, P/N 549017, (6) GMT Fuse Positions” on page 19.
- 7) Order DC input lugs as required per “Crimp Lugs and Busbar Adapter Kits” starting on page 22.
- 8) Order load distribution lugs as required. For bullet nose type distribution positions, also order load distribution lug adapters P/N 559805 for 3-pole devices, P/N 559804 for 2-pole devices, and P/N 559803 for 1-pole devices as required. See “Crimp Lugs and Busbar Adapter Kits” starting on page 22.
- 9) Order a system frame ground lug as required per “Crimp Lugs and Busbar Adapter Kits” starting on page 22.
- 10) Order a CO ground lug as required per “Crimp Lugs and Busbar Adapter Kits” starting on page 22.

Vertiv™ NetSure™ DCS48/58-600 Converter System

System Application Guide

584641000 List 02: -48 VDC to -58 VDC Converter System, 23" Rack Mounted, 400 A Maximum, Twenty-Six (26) Bullet Nose Type Distribution Positions, With Load Disconnect Contactor

Features

Provides a converter system consisting of the following factory packaged components.

- ◆ One (1) DC distribution cabinet with 1-row twenty-six (26) bullet nose type distribution positions.
- ◆ One (1) 5-position converter module mounting shelf with controller mounting slot.
- ◆ One (1) 6-position converter module mounting shelf.
- ◆ One (1) 1RU wiring space panel.
- ◆ Accepts one (1) NCU controller.
- ◆ Includes the IB4 board (provides a network connection point for NCU remote access).
- ◆ Includes the IB2 controller interface board (provides eight (8) programmable form C- relay outputs, eight (8) programmable binary inputs, and two (2) temperature inputs).
- ◆ Includes a system interface board.
- ◆ Includes factory installed SPD (Surge Protection Device) factory wired to the -58 VDC output. A circuit breaker is provided to remove power from the SPD device for maintenance.
- ◆ Accepts up to two (2) field installed expansion converter module mounting shelves.
- ◆ Accepts one (1) field installed expansion DC distribution cabinet.
- ◆ Includes a load disconnect contactor. This contactor is to be controlled from a host NetSure™ -48 VDC power system's NCU controller.
- ◆ Includes a load disconnect contactor remote driver jumper. See “Field Installed Load Disconnect Contactor Remote Driver Jumper, P/N 60067965” on page 15.
- ◆ Includes an SPD earth ground lug. See “SPD (Surge Protection Device) Earth Ground Connection” on page 29.

Restrictions

Mounts in a 23" wide relay rack or equipment rack.

Up to two (2) expansion converter module mounting shelves can be added to a List 02, field installed only.

One (1) expansion DC distribution cabinet can be added to a List 02, field installed only.

Ordering Notes

- 1) Order one (1) NCU Controller P/N 1M830BNA (see page 12).
Also specify appropriate configuration file for your site.
- 2) Order converter modules P/N 1C48582000P3 quantity as needed per system (see page 14).
- 3) Order a converter mounting position blank cover panel P/N SXA1100035/1 for each empty converter mounting position in the system as desired (see page 14).
- 4) Order optional temperature probes for ambient and battery temperature monitoring as required. Refer to “Optional Temperature Probes” on page 13.
- 5) Order distribution fuses and/or circuit breakers as required per “Distribution Devices” starting on page 15.
- 6) Order 6-position GMT fuse block P/N 549017 and fuses as required per “Optional Bullet Nose Type 6-Position GMT Distribution Fuse Block, P/N 549017, (6) GMT Fuse Positions” on page 19.
- 7) Order DC input lugs as required per “Crimp Lugs and Busbar Adapter Kits” starting on page 22.
- 8) Order load distribution lugs as required. For bullet nose type distribution positions, also order load distribution lug adapters P/N 559805 for 3-pole devices, P/N 559804 for 2-pole devices, and P/N 559803 for 1-pole devices as required. See “Crimp Lugs and Busbar Adapter Kits” starting on page 22.
- 9) Order a system frame ground lug as required per “Crimp Lugs and Busbar Adapter Kits” starting on page 22.
- 10) Order a CO ground lug as required per “Crimp Lugs and Busbar Adapter Kits” starting on page 22.

Vertiv™ NetSure™ DCS48/58-600 Converter System

System Application Guide

584641000 List 03: -48 VDC to -58 VDC Converter System, 23" Rack Mounted, 600 A Maximum, Four (4) GJ/218 Type Circuit Breaker Positions, Without Load Disconnect Contactor

Features

Provides a converter system consisting of the following factory packaged components.

- ◆ One (1) DC distribution cabinet with four (4) GJ/218 type circuit breaker mounting positions.
- ◆ One (1) 5-position converter module mounting shelf with controller mounting slot.
- ◆ One (1) 6-position converter module mounting shelf.
- ◆ One (1) 1RU wiring space panel.
- ◆ Accepts one (1) NCU controller.
- ◆ Includes the IB4 board (provides a network connection point for NCU remote access).
- ◆ Includes the IB2 controller interface board (provides eight (8) programmable form C- relay outputs, eight (8) programmable binary inputs, and two (2) temperature inputs).
- ◆ Includes a system interface board.
- ◆ Includes factory installed SPD (Surge Protection Device) factory wired to the -58 VDC output. A circuit breaker is provided to remove power from the SPD device for maintenance.
- ◆ Accepts up to two (2) field installed expansion converter module mounting shelves.
- ◆ Includes an SPD earth ground lug. See “SPD (Surge Protection Device) Earth Ground Connection” on page 29.

Restrictions

Mounts in a 23" wide relay rack or equipment rack.

Up to two (2) expansion converter module mounting shelves can be added to a List 03, field installed only.

One (1) expansion DC distribution cabinet can be added to a List 03, field installed only.

Ordering Notes

- 1) Order one (1) NCU Controller P/N 1M830BNA (see page 12).
Also specify appropriate configuration file for your site.
- 2) Order converter modules P/N 1C48582000P3 quantity as needed per system (see page 14).
- 3) Order a converter mounting position blank cover panel P/N SXA1100035/1 for each empty converter mounting position in the system as desired (see page 14).
- 4) Order optional temperature probes for ambient and battery temperature monitoring as required. Refer to “Optional Temperature Probes” on page 13.
- 5) Order distribution fuses and/or circuit breakers as required per “Distribution Devices” starting on page 15.
- 6) Order 6-position GMT fuse block P/N 549017 and fuses as required per “Optional Bullet Nose Type 6-Position GMT Distribution Fuse Block, P/N 549017, (6) GMT Fuse Positions” on page 19.
- 7) Order DC input lugs as required per “Crimp Lugs and Busbar Adapter Kits” starting on page 22.
- 8) Order load distribution lugs as required. See “Crimp Lugs and Busbar Adapter Kits” starting on page 22.
- 9) Order a system frame ground lug as required per “Crimp Lugs and Busbar Adapter Kits” starting on page 22.
- 10) Order a CO ground lug as required per “Crimp Lugs and Busbar Adapter Kits” starting on page 22.

Vertiv™ NetSure™ DCS48/58-600 Converter System

System Application Guide

584641000 List 04: -48 VDC to -58 VDC Converter System, 23" Rack Mounted, 600 A Maximum, Four (4) GJ/218 Type Circuit Breaker Positions, With Load Disconnect Contactor

Features

- ◆ Provides a converter system consisting of the following factory packaged components.
- ◆ One (1) DC distribution cabinet with four (4) GJ/218 type circuit breaker mounting positions.
- ◆ One (1) 5-position converter module mounting shelf with controller mounting slot.
- ◆ One (1) 6-position converter module mounting shelf.
- ◆ One (1) 1RU wiring space panel.
- ◆ Accepts one (1) NCU controller.
- ◆ Includes the IB4 board (provides a network connection point for NCU remote access).
- ◆ Includes the IB2 controller interface board (provides eight (8) programmable form C- relay outputs, eight (8) programmable binary inputs, and two (2) temperature inputs).
- ◆ Includes a system interface board.
- ◆ Includes factory installed SPD (Surge Protection Device) factory wired to the -58 VDC output. A circuit breaker is provided to remove power from the SPD device for maintenance.
- ◆ Accepts up to two (2) field installed expansion converter module mounting shelves.
- ◆ Includes a load disconnect contactor. This contactor is to be controlled from a host NetSure™ -48 VDC power system's NCU controller.
- ◆ Includes a load disconnect contactor remote driver jumper. See "Field Installed Load Disconnect Contactor Remote Driver Jumper, P/N 60067965" on page 15.
- ◆ Includes an SPD earth ground lug. See "SPD (Surge Protection Device) Earth Ground Connection" on page 29.

Restrictions

Mounts in a 23" wide relay rack or equipment rack.

Up to two (2) expansion converter module mounting shelves can be added to a List 04, field installed only.

One (1) expansion DC distribution cabinet can be added to a List 04, field installed only.

Ordering Notes

- 1) Order one (1) NCU Controller P/N 1M830BNA (see page 12).
Also specify appropriate configuration file for your site.
- 2) Order converter modules P/N 1C48582000P3 quantity as needed per system (see page 14).
- 3) Order a converter mounting position blank cover panel P/N SXA1100035/1 for each empty converter mounting position in the system as desired (see page 14).
- 4) Order optional temperature probes for ambient and battery temperature monitoring as required. Refer to "Optional Temperature Probes" on page 13.
- 5) Order distribution fuses and/or circuit breakers as required per "Distribution Devices" starting on page 15.
- 6) Order 6-position GMT fuse block P/N 549017 and fuses as required per "Optional Bullet Nose Type 6-Position GMT Distribution Fuse Block, P/N 549017, (6) GMT Fuse Positions" on page 19.
- 7) Order DC input lugs as required per "Crimp Lugs and Busbar Adapter Kits" starting on page 22.
- 8) Order load distribution lugs as required. See "Crimp Lugs and Busbar Adapter Kits" starting on page 22.
- 9) Order a system frame ground lug as required per "Crimp Lugs and Busbar Adapter Kits" starting on page 22.
- 10) Order a CO ground lug as required per "Crimp Lugs and Busbar Adapter Kits" starting on page 22.

Vertiv™ NetSure™ DCS48/58-600 Converter System

System Application Guide

584641000 List 10: Field Installed Expansion Converter Module Mounting Shelf

Features

- ◆ One (1) 6-position converter module mounting shelf.

Restrictions

Mounts directly below the system's bottom converter module mounting shelf.

Field installed only.

Maximum of two (2) expansion converter module mounting shelves (four total shelves) per system.

Ordering Notes

- 1) Order one (1) or two (2) List 10 as required.
- 2) Order up to six (6) converter modules P/N 1C48582000P3 (see page 14).
- 3) Order a converter mounting position blank cover panel P/N SXA1100035/1 for each empty converter mounting position in the shelf as desired (see page 14).
- 4) Order DC input lugs as required per "Crimp Lugs and Busbar Adapter Kits" starting on page 22.

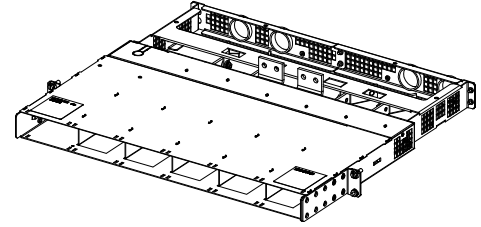

584641000 List AL: Field Installed DC Distribution Cabinet, Twenty-Six (26) Bullet Nose Type Distribution Positions, Without Load Disconnect Contactor

Features

- ◆ One (1) DC distribution cabinet with 1-row twenty-six (26) bullet nose type distribution mounting positions.
- ◆ Includes a 1RU wiring space panel.

Restrictions

Mounts directly above the system's 1RU wiring space panel.

Field installed only.

Only one (1) expansion DC distribution cabinet per system.

Ordering Notes

- 1) Order one (1) List AL or List CL as required.
- 2) Order distribution fuses and/or circuit breakers as required per "Distribution Devices" starting on page 15.
- 3) Order load distribution lugs as required. For bullet nose type distribution positions, also order load distribution lug adapters P/N 559805 for 3-pole devices, P/N 559804 for 2-pole devices, and P/N 559803 for 1-pole devices as required. See "Crimp Lugs and Busbar Adapter Kits" starting on page 22.
- 4) Order a system frame ground lug as required per "Crimp Lugs and Busbar Adapter Kits" starting on page 22.
- 5) Order a CO ground lug as required per "Crimp Lugs and Busbar Adapter Kits" starting on page 22.

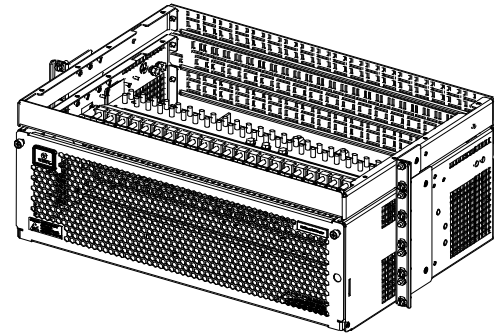

584641000 List CL: Field Installed DC Distribution Cabinet, Twenty-Six (26) Bullet Nose Type Distribution Positions, With Load Disconnect Contactor

Features

- ◆ One (1) DC distribution cabinet with 1-row twenty-six (26) bullet nose type distribution positions.
- ◆ Includes a 1RU wiring space panel.
- ◆ Includes a load disconnect contactor. This contactor is to be controlled from a host NetSure™ -48 VDC power system's NCU controller.
- ◆ Includes a load disconnect contactor remote driver jumper. See "Field Installed Load Disconnect Contactor Remote Driver Jumper, P/N 60067965" on page 15.

Restrictions

Mounts directly above the system's 1RU wiring space panel.

Field installed only.

Only one (1) expansion DC distribution cabinet per system.

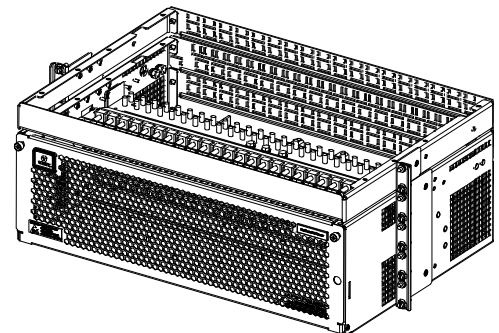

Vertiv™ NetSure™ DCS48/58-600 Converter System

System Application Guide

Ordering Notes

- 1) Order one (1) List AL or List CL as required.
- 2) Order distribution fuses and/or circuit breakers as required per “Distribution Devices” starting on page 15.
- 3) Order load distribution lugs as required. For bullet nose type distribution positions, also order load distribution lug adapters P/N 559805 for 3-pole devices, P/N 559804 for 2-pole devices, and P/N 559803 for 1-pole devices as required. See “Crimp Lugs and Busbar Adapter Kits” starting on page 22.
- 4) Order a system frame ground lug as required per “Crimp Lugs and Busbar Adapter Kits” starting on page 22.
- 5) Order a CO ground lug as required per “Crimp Lugs and Busbar Adapter Kits” starting on page 22.

ACCESSORY DESCRIPTIONS

Controller

NCU (NetSure™ Control Unit) Controller, P/N 1M830BNA

Features

- ◆ NCU Controller, Model M830BNA (Spec. No. 1M830BNA).
- ◆ Factory programmed with the configuration file specified when ordered.
Note: The controller is provided with the factory default configuration unless otherwise specified.
Note: Contact us for custom NCU configurations.
- ◆ Refer to the NCU Controller Instructions (UM1M830BNA) for more information.

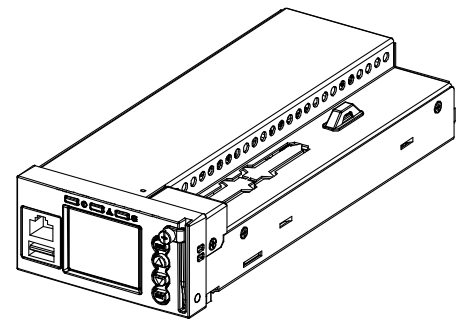

Restrictions

Only one (1) controller per converter system is required.

Ordering Notes

- 1) Order one (1) NCU controller per converter system, P/N 1M830BNA.
- 2) Order up to two (2) optional temperature probes for ambient and battery temperature monitoring as required. Refer to “Optional Temperature Probes” on page 13.
- 3) Order optional SM-Temp Temperature Concentrator (Supervisory Module for Temperature Probes) as desired (shipped loose) (see page 14). Also order SM-Temp CAN Bus Interface Cable, P/N 562868, and “SM-Temp Jumpers, P/N 552888” (see page 14) as required. Order optional temperature probes as required (refer to “Optional Temperature Probes” on page 13).
Note: A system can have up to (8) SM-Temp modules (each of which can accept up to eight temperature probes) that can be used in the system for ambient and battery monitoring.
- 4) Ordering an NCU for replacing an NCU or as a spare NCU.

If the NCU is to be used as a replacement in a specific system, it should be ordered with the same configuration file as the original NCU controller. Each configuration file is identified by a part number. The controller part number ends with this configuration file part number. For example, NCU controller part number 1M830BNA10044525 uses configuration file part number is 10044525. If the part number does not have these characters, the configuration file number can be found on the controller nameplate – “Programmed with Configuration File #####”. The controller may also have a Unique Identification Number (UIN). This number indicates that certain parameters were set at the factory to match the controller to the options selected with the power plant. If the controller has a UIN, the plant will have shipped with a USB drive labelled with the UIN. The UIN label may also be located near the controller slot in the system. If the controller has a UIN, provide this UIN number, along with the configuration number, when ordering so that the new controller will match that of the original controller shipped with the system. The user manual provided with the controller provides instructions for replacing and programming the controller. It is important to follow these instructions carefully. The user manual also provides instructions for saving certain controller files that are created when changes are made to the system after leaving the factory. These files can be programmed into the replacement controller so it can match the latest saved state of the original controller.

If the NCU is being ordered as a spare part for any of a group of power plants, the same procedure can be followed. If the replacement controller’s configuration does not match that of the original controller, the original files can be retrieved from the USB drive shipped with the plant, if available. If the USB drive is not available, contact the factory or Technical Assistance Center (TAC) to obtain a copy of the original configuration file (all package) so it can be programmed into the new controller.

Vertiv™ NetSure™ DCS48/58-600 Converter System

System Application Guide

Optional Temperature Probes

Features

- ◆ Up to two (2) temperature probes can be connected to the IB2 (Controller Interface Board).
- ◆ Up to eight (8) temperature probes can be connected to an optional SM-Temp Temperature Concentrator.
- ◆ The temperature probes can be programmed to monitor ambient temperature and/or battery temperature.
- ◆ The temperature sensor end of the probe contains a tab with a 5/16" clearance hole for mounting.

Restrictions

A temperature probe programmed to monitor battery temperature should be mounted on the negative post of a battery cell to sense battery temperature. A temperature probe programmed to monitor ambient temperature should be mounted in a convenient location, away from direct sources of heat or cold.

Ordering Notes

- 1) Order temperature probes as required. Note that each temperature probe consists of two or three pieces which plug together to make a complete probe (see the following illustration). For a complete temperature probe, order one (1) P/N 552992 (10.3 meters) or one (1) P/N 556155 (3.3 meters). If additional length is required, order temperature probe extension cable P/N 04119122 (10 meters).

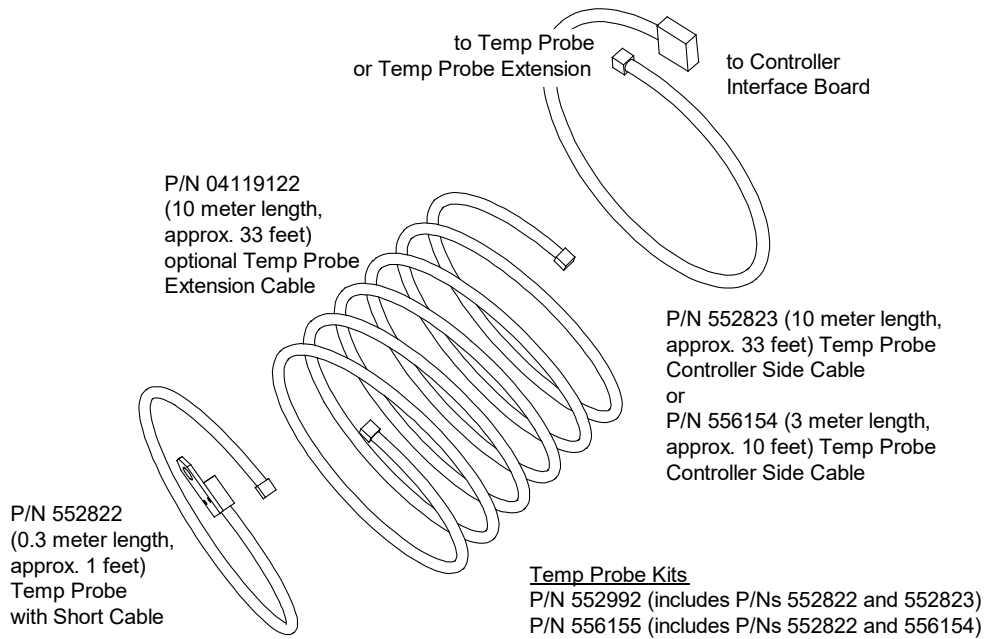

Optional SM-Temp Temperature Concentrator

SM-Temp Temperature Concentrator, P/N 547490

Features

- ◆ Allows for multiple temperature probes to be used for ambient temperature monitoring and/or battery temperature monitoring.
- ◆ Provides (8) temperature probe inputs per SM-Temp unit.
- ◆ Can cascade up to (8) SM-Temp units, connecting up to sixty-four (64) temperature probes.
- ◆ The SM-Temp Concentrator is connected at the end of the NCU CAN bus. Via the CAN Bus, the NCU reads each temperature probe from each SM-Temp Concentrator.
- ◆ Refer to the SM-Temp Temperature Concentrator Instructions (UM547490) for more information.

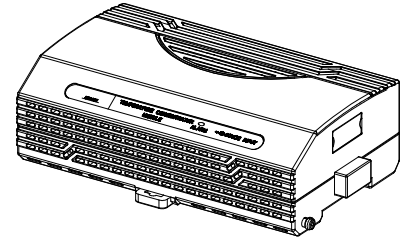

Ordering Notes

- 1) Order SM-Temp Temperature Concentrator, P/N 547490, as required.
- 2) Order up to (8) temperature probes for each concentrator. See “Optional Temperature Probes” on page 13.
- 3) Order one (1) SM-Temp CAN Bus Interface Cable, P/N 562868, to connect the SM-Temp into the controller’s CAN bus.
- 4) Order SM-Temp jumpers (P/N 552888) to interconnect SM-Temp units, as required. See “SM-Temp Jumpers, P/N 552888” on page 14.

SM-Temp Jumpers, P/N 552888

Features

- ◆ Provides 20’ of 18 AWG solid red / black twisted pair cable and three (3) wire splices for connecting the CAN bus of multiple SM-Temp modules together.

Ordering Notes

- 1) Order P/N 552888 as required.

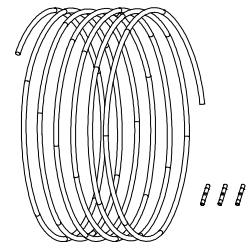

Converter

-48 VDC to -58 VDC Converter Module, P/N 1C48582000P3

Features

- ◆ Model C48/58-2000P3 (Spec. No. 1C48582000P3) 2000 W / -48 VDC to -58 VDC converter module.
- ◆ Refer to the Converter Instructions (UM1C48582000P3) for more information.

Ordering Notes

- 1) Order by P/N 1C48582000P3 as required.

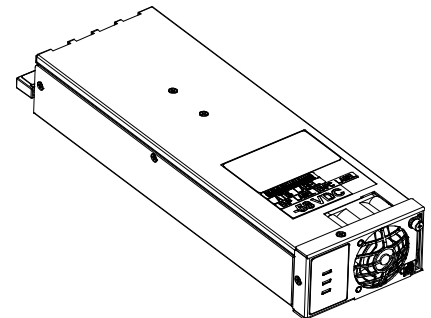

Module Mounting Position Blank Cover Panel

Module Mounting Position Blank Cover Panel, P/N SXA 110 0035/1

Features

- ◆ Covers one (1) unused module mounting position.

Ordering Notes

- 1) Order by P/N SXA 110 0035/1 as required. Order a module mounting position blank cover panel for each empty module mounting position in the system, as desired.

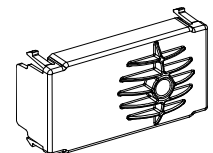

Field Installed Load Disconnect Contactor Kit, P/N 60082562

Features

- ◆ Provides a load disconnect contactor to be field installed in a system without a contactor.
- ◆ Provides a load disconnect contactor wiring harness jumper (P/N RPM2300003/1).
- ◆ Provides a load disconnect contactor remote driver jumper, P/N 60067965.

Restrictions

Field installed only.

Ordering Notes

- 1) Order by part number 60082562 as required.

Field Installed Load Disconnect Contactor Remote Driver Jumper, P/N 60067965

Features

- ◆ Provides a load disconnect contactor remote driver jumper. This allows the load disconnect contactor to be controlled by a remote Vertiv™ NetSure™ -48 VDC power system.

Restrictions

Field installed only.

Included with List 02, List 04, and List CL.

Ordering Notes

- 1) Order by part number 60067965 as required.
- 2) If the remote -48 VDC power system is a Vertiv™ NetSure™ 512, also order jumper P/N 60031372.

Distribution Devices

Bullet Nose Type Circuit Breakers and Bullet Nose Type Fuseholders e/w TPS/TLS Fuses

Features

- ◆ Each circuit breaker (as listed in Table 1) plugs into one, two, or three mounting position(s) on a distribution panel containing bullet nose type distribution positions.
- ◆ A single fuseholder provides for installation of a 3 A to 100 A Bussmann TPS type or Littelfuse TLS type fuse (as listed in Table 2). This fuseholder plugs into a single mounting position on a distribution panel containing bullet nose type distribution positions. This fuseholder provides a GMT-A alarm type fuse, which operates open to provide an alarm indication if the associated distribution fuse opens.

Restrictions

For use in List 01, List 02, List AL, and List CL DC distribution cabinet only.

Load should not exceed 80% of device rating.

Install distribution devices from left to right, starting with the highest capacity and working to the lowest capacity.

125 A, 150 A, 175 A, and 200 A circuit breakers occupy two mounting positions.

225 A, 250 A, and 300 A circuit breakers occupy three mounting positions.

Caution: *A 150 A or greater circuit breaker shall have an empty mounting position between it and any other overcurrent protective device.*

Ordering Notes

- 1) Order distribution circuit breakers as required per Table 1.
- 2) Order distribution fuses as required per Table 2. For each fuse ordered, also order one (1) P/N 117201 bullet nose type fuseholder. Order replacement alarm fuses (18/100A) per Table 8 on page 25.
- 3) See Table 11 on page 33 or Table 12 on page 34 for recommended load distribution wire sizes and lugs.
- 4) Order load distribution lugs as required. For bullet nose type distribution positions, also order load distribution lug adapters P/N 559805 for 3-pole devices, P/N 559804 for 2-pole devices, and P/N 559803 for 1-pole devices as required. See “Crimp Lugs and Busbar Adapter Kits” starting on page 22.

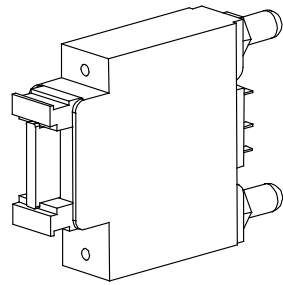

Bullet Nose Fuseholder

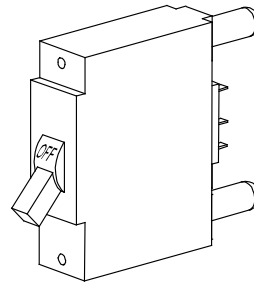

Toggle Handle
 Bullet Nose Circuit Breaker

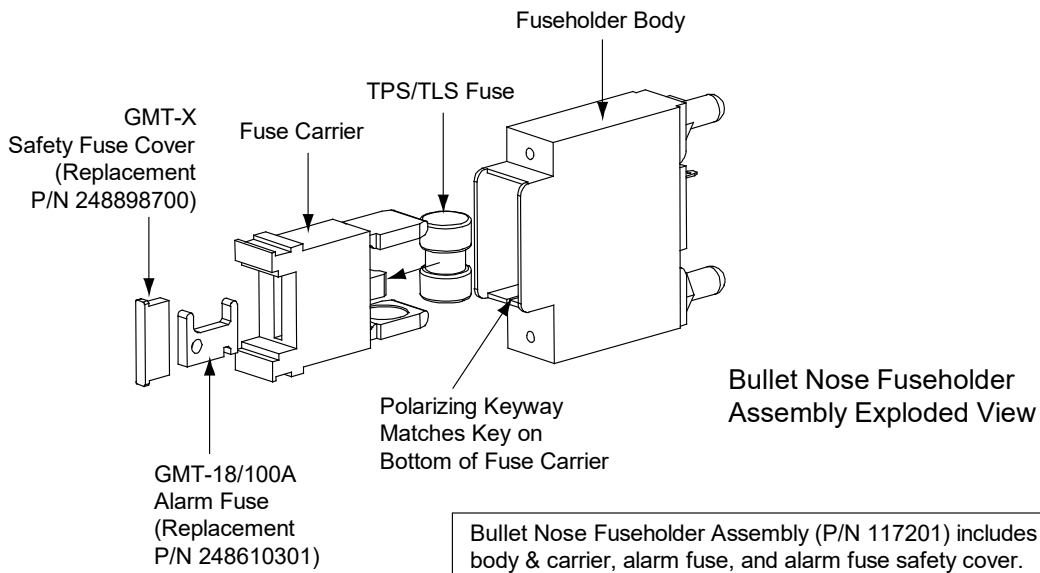

Vertiv™ NetSure™ DCS48/58-600 Converter System

System Application Guide

Ampere Rating	Number of Poles	Part Number	
		Electrical Trip ¹ (White Handle)	Electrical/ Mechanical Trip ² (Black Handle)
1	1	102272	101596
3	1	102273	101597
5	1	102274	101598
10	1	102275	101599
15	1	102276	101600
20	1	102277	101601
25	1	102278	101602
30	1	102279	101603
35	1	102280	101604
40	1	102281	101605
45	1	121998	121997
50	1	102282	101606
60	1	102283	101607
70	1	102284	101608
75	1	102285	101609
80	1	121996	121995
90	1	138887	138888
100	1	102286	101610
125	2	516991	516838
150	2	516993	516839
175	2	144883	144884
200	2	121831	121832
225	3	144885	144886
250	3	121835	121836
300	3	149075	149076
Order load distribution lugs as required. Also order load distribution lug adapters P/N 559805 for 3-pole devices, P/N 559804 for 2-pole devices, and P/N 559803 for 1-pole devices as required. See "Crimp Lugs and Busbar Adapter Kits" starting on page 22.			
See Table 11 on page 33 or Table 12 on page 34 for recommended load distribution wire sizes and lugs.			

Circuit Breaker Alarm Operation:

- ¹ Provides an alarm during an electrical trip condition only.
- ² Provides an alarm during an electrical or manual trip condition.

Table 1
Toggle Handle Bullet Nose Type Circuit Breakers

Vertiv™ NetSure™ DCS48/58-600 Converter System

System Application Guide

Ampere Rating	Part Number	Bussmann P/N	Littelfuse P/N
3	248230900	TPS-3	TLS003
5	248231000	TPS-5	TLS005
6	248231200	TPS-6	TLS006
10	248231500	TPS-10	TLS010
15	248231800	TPS-15	TLS015
20	248232100	TPS-20	TLS020
25	248232400	TPS-25	TLS025
30	248232700	TPS-30	TLS030
40	248233300	TPS-40	TLS040
50	248233900	TPS-50	TLS050
60	248234200	TPS-60	TLS060
70	248234500	TPS-70	TLS070
80	118413	--	TLS080
90	118414	--	TLS090
100	118415	--	TLS100
Bullet Nose Type Fuseholder		P/N 117201 (Includes Fuseholder, 18/100 A GMT-A Alarm Fuse, and GMT-X Safety Fuse Cover)	
Order load distribution lugs as required. Also order load distribution lug adapters P/N 559805 for 3-pole devices, P/N 559804 for 2-pole devices, and P/N 559803 for 1-pole devices as required. See "Crimp Lugs and Busbar Adapter Kits" starting on page 22.			
See Table 11 on page 33 or Table 12 on page 34 for recommended load distribution wire sizes and lugs.			

Table 2
Bullet Nose Type Fuseholders and TPS/TLS Fuses

Vertiv™ NetSure™ DCS48/58-600 Converter System

System Application Guide

Optional Bullet Nose Type 6-Position GMT Distribution Fuse Block, P/N 549017, (6) GMT Fuse Positions

Features

- ◆ Provides six (6) load distribution fuse positions (1/4 A to 15 A GMT alarm-type fuses).
- ◆ Mounts in two (2) distribution positions of a “bullet nose” distribution panel.
- ◆ Screw clamp type load and load return terminals provided.
- ◆ Includes six (6) dummy fuses equipped with safety fuse covers.

Restrictions

Occupies two (2) bullet device mounting positions.

Terminal block wire size capacity is 26 AWG to 14 AWG.

The GMT fuses have an interrupting rating of 450 A @ 60 VDC.

At 40 °C Ambient:

- **Maximum total current is 42 A.**
- **Maximum fuse size is 15 A.**
- **When used for power distribution, load should not exceed 80% of device rating, except 10 A and 15 A fuses for which load should not exceed 70% of device rating.**
- **GMT fuses greater than 10 A SHALL have an empty mounting position between it and any other fuse.**

At 65 °C Ambient:

- **Maximum total current is 24 A.**
- **Maximum fuse size is 10 A.**
- **When used for power distribution, load should not exceed 80% of device rating, except 10 A fuses for which load should not exceed 70% of device rating.**
- **GMT fuses greater than 5 A SHALL have an empty mounting position between it and any other fuse.**

Ordering Notes

- 1) Order optional Bullet Nose Type 6-Position GMT Fuse Block (P/N 549017) as required. Provides one alarm fuse distribution assembly, ground return link, and hardware.
- 2) Order fuses as required per Table 3.

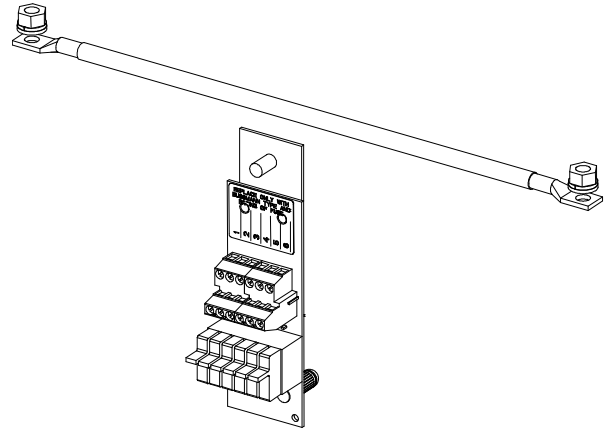

Vertiv™ NetSure™ DCS48/58-600 Converter System

System Application Guide

GMT Type Load Distribution Fuses

Features

- ◆ An optional “Bullet Nose Type 6-Position GMT Distribution Fuse Block, P/N 549017” is available for additional load distribution.

Restrictions

When used for power distribution, load should not exceed 80% of device rating, except 10 A and 15 A fuses, for which load should not exceed 70% of device rating.

See also “Restrictions” under “Optional Bullet Nose Type 6-Position GMT Distribution Fuse Block, P/N 549017, (6) GMT Fuse Positions” on page 19.

Ordering Notes

- 1) Order fuses as required per Table 3.

Ampere Rating	Part Number	Fuse Color
18/100 (GMT-A)	248610301	---
1/4	248610200	VIOLET
1/2	248610300	RED
3/4	248610500	BROWN
1-1/3	248610700	WHITE
2	248610800	ORANGE
3	248610900	BLUE
5	248611000	GREEN
7-1/2	248611300	BLACK-WHITE
10	248611200	RED-WHITE
15	248611500	RED-BLUE
Replacement Safety Fuse Cover (GMT-Y)	102774	---
Replacement Dummy Fuse	248872600	---

Table 3
GMT Fuses

Vertiv™ NetSure™ DCS48/58-600 Converter System

System Application Guide

GJ/218 Type Circuit Breakers

Features

- ◆ Each circuit breaker (as listed in Table 4) requires one, two, three, or four mounting position(s) on a distribution panel containing GJ/218 type distribution positions.

Restrictions

For use in List 03 and List 04 DC distribution cabinet only.

Load should not exceed 80% of device rating.

Ordering Notes

- 1) Order distribution circuit breakers as required per Table 4.
- 2) Order a jumper kit as required for each circuit breaker per Table 4.
- 3) A two-hole lug with 3/8" bolt clearance holes on 1" centers is required for each distribution position (order per Table 6 on page 23).
- 4) See Table 12 on page 34 for recommended load distribution wire sizes and lugs.

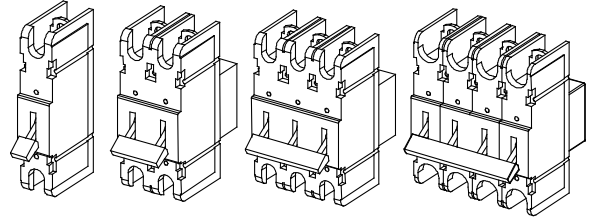

GJ/218 Circuit Breakers

Ampere Rating	No. of Positions	P/N Electrical/Mechanical Trip ¹	P/N Electrical Trip ²	Breaker Mounting Kit
100	1	256621700	256621300	503787
125	1	256621600	256621400	503787
150	1	256621800	256622400	503787
175	1	256621900	256622500	503787
200	1	256622200	256622600	503787
225	1	256622900	256622700	503787
250	1	256623500	256623400	503787
300	2	256625300	103572	513961
400	2	256626200	256626300	513961
600	3	256628200	103571	513957
800	4	121657	121658	554091
Order lugs from Table 6 on page 23.				
See Table 12 on page 34 for recommended load distribution wire sizes and lugs.				

^{1,2} Circuit Breaker Alarm Operation:

¹ Provides an alarm during an electrical or manual trip condition.

² Provides an alarm during an electrical trip condition only.

Table 4
GJ/218 Circuit Breakers

Crimp Lugs and Busbar Adapter Kits

Standard Crimp Lugs (Two-Hole, 1/4" Bolt Clearance Hole, 5/8" Centers)

Features

- ◆ The system provides 1/4-20 studs to secure lugs for the following wiring points. Refer to Table 5 for available lugs.
 - DC Input Leads
 - Load Distribution Leads (Bullet Nose Type Distribution Positions)
 - System Frame Ground Lead
 - CO Ground Lead
 - SPD Earth Ground Lead

Restrictions

DC Input Lugs Requirements: Two-hole lug, 1/4" clearance holes on 5/8" centers. Maximum lug width, 1.12 inches. Customer must supply additional lug mounting hardware. Maximum size of wire is 4/0 AWG.

Load Distribution Lugs Requirements (Bullet Nose Type Distribution Positions): Two-hole lug, 1/4" clearance holes on 5/8" centers. Maximum lug width, 0.625 inches. Customer must supply additional lug mounting hardware. Maximum size of wire to be connected to a single fuseholder/circuit breaker position is 2 AWG. Order load distribution lug adapters P/N 559805 for 3-pole devices, P/N 559804 for 2-pole devices, and P/N 559803 for 1-pole devices as required. See "Busbar Lug Adapter Kits" on page 24. See also "Standard Crimp Lugs (Two-Hole, 3/8" Bolt Clearance Hole, 1" Centers)" on page 23 when lug adapters P/N 559804 and 559805 are used.

System Frame Ground Lug Requirements: Two-hole lug, 1/4" clearance holes on 5/8" centers. Lug mounting hardware provided.

CO Ground Lug Requirements: Two-hole lug, 1/4" clearance holes on 5/8" centers. Lug mounting hardware provided.

SPD Earth Ground Lug Requirements: Two-hole lug, 1/4" clearance holes on 5/8" centers. Lug and lug mounting hardware provided.

Ordering Notes

- 1) Specify part number from Table 5 for desired lead size.

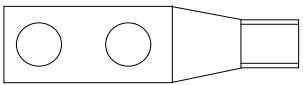
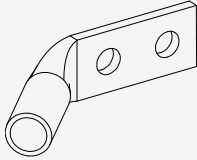
Lead Size	Part Number	
14 AWG to 10 AWG	245342300	
8 AWG	245390200	
6 AWG	245346700	
4 AWG	245346800	
2 AWG	245346900	
1/0 AWG	116350	
2/0 AWG	119213	
4/0 AWG	118331	
2 AWG Flex Wire	60057201	 <p>Factory Provided for SPD Earth Ground Lead</p>

Lugs should be crimped per lug manufacturer's specifications.

Table 5
Crimp Lug (Two-Hole, 1/4" Bolt Clearance Hole, 5/8" Centers)

Vertiv™ NetSure™ DCS48/58-600 Converter System

System Application Guide

Standard Crimp Lugs (Two-Hole, 3/8" Bolt Clearance Hole, 1" Centers)

Features

- ◆ The system provides 3/8-16 studs to secure lugs for the following wiring points. Refer to Table 6 for available lugs.
 - Load Distribution Leads (GJ/218 Type Distribution Positions)
- ◆ Load lug adapters P/N 559804 and 559805 convert the 1/4-20 on 5/8" centers load lug landings for bullet nose type distribution positions to 3/8-16 on 1" centers load lug landings.

Restrictions

Load Distribution Lugs Requirements (GJ/218 Type Distribution Positions): Two-hole lug, 3/8" clearance holes on 1" centers. Maximum lug width, 1.375 inches. Customer must supply additional lug mounting hardware.

Ordering Notes

- 1) Specify part number from Table 6 for desired lead size.

Lead Size	Part Number
6 AWG	245349900
4 AWG	245350000
2 AWG	245348200
1/0 AWG	245347100
2/0 AWG	245347200
3/0 AWG	245347300
4/0 AWG	245347400
250 kcmil	245347500
300 kcmil	245347600
350 kcmil	245347700
400 kcmil	245347800
500 kcmil	245347900
600 kcmil	245348000
750 kcmil	245348100

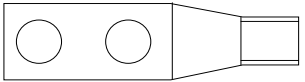

Lugs should be crimped per lug manufacturer's specifications.

Table 6
Crimp Lug (Two-Hole, 3/8" Bolt Clearance Hole, 1" Centers)

Vertiv™ NetSure™ DCS48/58-600 Converter System

System Application Guide

Busbar Lug Adapter Kits

Features

- ◆ See Table 7 for part numbers and descriptions of available items.

Ordering Notes

- 1) Order by part number from Table 7 as required.

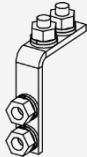
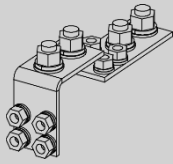
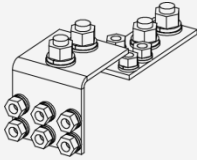
Part Number	Description	
559803	<u>Busbar Lug Adapter Kit</u> : Converts one (1) load position (1/4-20 on 5/8" centers) to one (1) load landing (1/4-20 on 5/8" centers), right angle.	
559804	<u>Busbar Lug Adapter Kit</u> : Converts two (2) load positions (1/4-20 on 5/8" centers) to one (1) landing (3/8-16 on 1" centers). Right angle load busbar and straight return busbar for rear wiring egress.	
559805	<u>Busbar Lug Adapter Kit</u> : Converts three (3) load positions (1/4-20 on 5/8" centers) to one (1) landing (3/8-16 on 1" centers). Right angle load busbar and straight return busbar for rear wiring egress.	

Busbar lug adapter kits include hardware shown.

Table 7
Busbar Lug Adapter Kits

Vertiv™ NetSure™ Power System Interface Kit, P/N 10064868

Features

- ◆ Provides kit components to interconnect the Vertiv™ NetSure™ DCS48/58-600 Converter System to a Vertiv™ NetSure™ -48 VDC Power System containing an NCU controller.
- ◆ This allows the NCU controller in the Vertiv™ NetSure™ -48 VDC Power System to manage the converter system without the need for the NCU in the converter system.
- ◆ Consists of a CAN jumper and jumpers to interface the converter system load fuse alarm, SPD fuse alarm, and SPD breaker alarm to the Vertiv™ NetSure™ -48 VDC Power System.

Restrictions

No NCU required in the Vertiv™ NetSure™ DCS48/58-600 Converter System.

Ordering Notes

- 1) Order by part number 10064868 as required.

Vertiv™ NetSure™ DCS48/58-600 Converter System

System Application Guide

User Replaceable Alarm Fuses

Ordering Notes

- 1) Order replacement fuses as required per Table 8.

Assembly	Desig.	Function	Size (Amperes)	Type	Part No.
TPS/TLS Fuseholders (P/N 117201)	FA	Fuse Alarm	18/100	Bussmann GMT-A	248610301
	--	--	--	Safety Fuse Cover (GMT-X)	248898700

Table 8
User Replaceable Alarm Fuses

User Replaceable Components

Ordering Notes

- 1) Order replacement components as required per Table 9.

Item	Part Number	
Converter Module	1C48582000P3	
NCU Controller	1M830BNA (SW configuration number required to order.)	
Temp Probe Sensor	552822	
Controller IB2 Interface Board	MA4C5U31	
Controller IB4 (second Ethernet port) Board	558076	
System Interface Board	555484	
For equipment provided with two SPD assemblies per output voltage circuit		
SPD (Surge Protection Device) Replacement Plug-in Module (Replacement module for SPD P/N 10034885. Each SPD P/N 10034885 has two P/N 10035033 replacement modules. Both modules should be replaced at the same time.)	10035033	
SPD (Surge Protection Device) Replacement Assembly (includes SPD mounting base with two installed P/N 10035033 SPD plug-in modules.)	10034885	

Table 9 (cont'd on next page)
User Replaceable Components

Vertiv™ NetSure™ DCS48/58-600 Converter System

System Application Guide

Item	Part Number	
For equipment provided with <u>one</u> SPD assembly per output voltage circuit		
SPD (Surge Protection Device) Replacement Plug-in Module (Replacement module for SPD P/N 10060979. Each SPD P/N 10060979 (Phoenix Contact Version) has four P/N 10035033 (Phoenix Contact only) replacement modules. All four modules should be the same.	10035033 (Phoenix Contact Only)	
SPD (Surge Protection Device) Replacement Assembly (includes SPD mounting base with four installed P/N 10035033 SPD plug-in modules.)	10060979 (Phoenix Contact Version)	
SPD (Surge Protection Device) Replacement Plug-in Module (Replacement module for SPD P/N 10060979. Each SPD P/N 10060979 (Bourns Version) has two P/N 10071911 replacement modules. Both modules should be replaced at the same time.)	10071911 (Bourns Only)	
SPD (Surge Protection Device) Replacement Assembly (includes SPD mounting base with two installed P/N 10071911 SPD plug-in modules.)	10060979 (Bourns Version)	

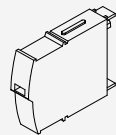
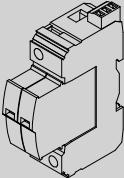
Table 9 (cont'd from previous page)
User Replaceable Components

RECOMMENDED WIRE SIZES, BRANCH CIRCUIT PROTECTION, CRIMP LUGS, AND WIRING ILLUSTRATIONS

System Shelf Frame Grounding Connection

For system shelf frame grounding requirements, refer to the current edition of the American National Standards Institute (ANSI) approved National Fire Protection Association's (NFPA) National Electrical Code (NEC), applicable local codes, and your specific site requirements.

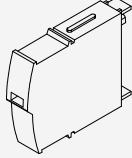
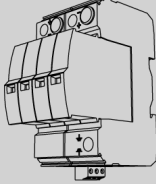
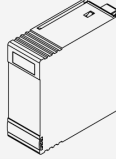
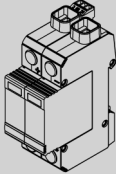
The frame grounding connection to the system shelf is made by using grounding washers with the mounting hardware used to secure the shelf to the relay rack or equipment rack. Refer to the system installation manual for a procedure. Ensure that the relay rack or equipment rack is properly grounded.

Two sets of frame grounding studs and hardware are also provided on the inside rear of the DC distribution cabinet. This provides for the connection of a frame grounding lead with a two-hole lug that has 1/4" bolt clearance holes on 5/8" centers. Connect a frame grounding lead to either set of studs as required. Refer to Figure 1 for location and recommended torque for this connection. Refer to Table 5 for lug selection.

Recommended frame ground wire size is 2 AWG.

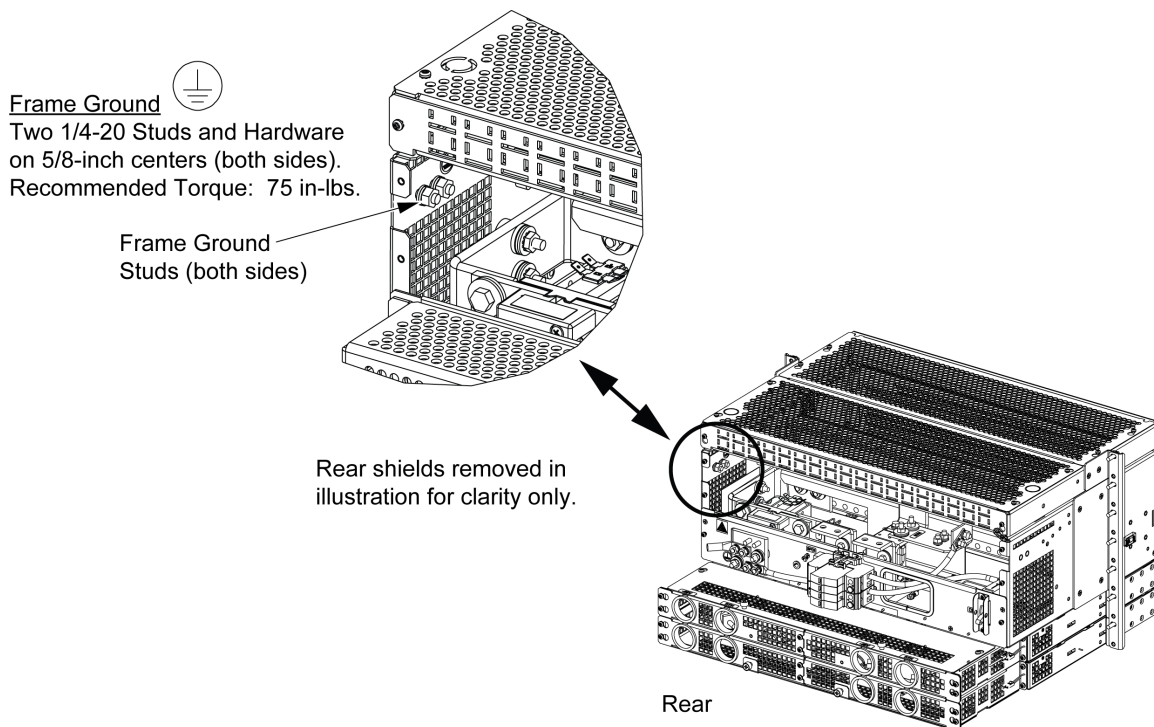

Figure 1
System Shelf Frame Grounding Connection

Central Office Ground Connection

For central office ground requirements, refer to the current edition of the American National Standards Institute (ANSI) approved National Fire Protection Association's (NFPA) National Electrical Code (NEC), applicable local codes, and your specific site requirements.

A set of studs and hardware are provided on the -58 VDC return bus located on the inside rear of the DC distribution cabinet. This provides for the connection of a central office ground lead with a two-hole lug that has 1/4" bolt clearance holes on 5/8" centers. Connect a central office ground lead to these studs as required. Refer to Figure 2 for location and recommended torque for this connection. Refer to Table 5 for lug selection.

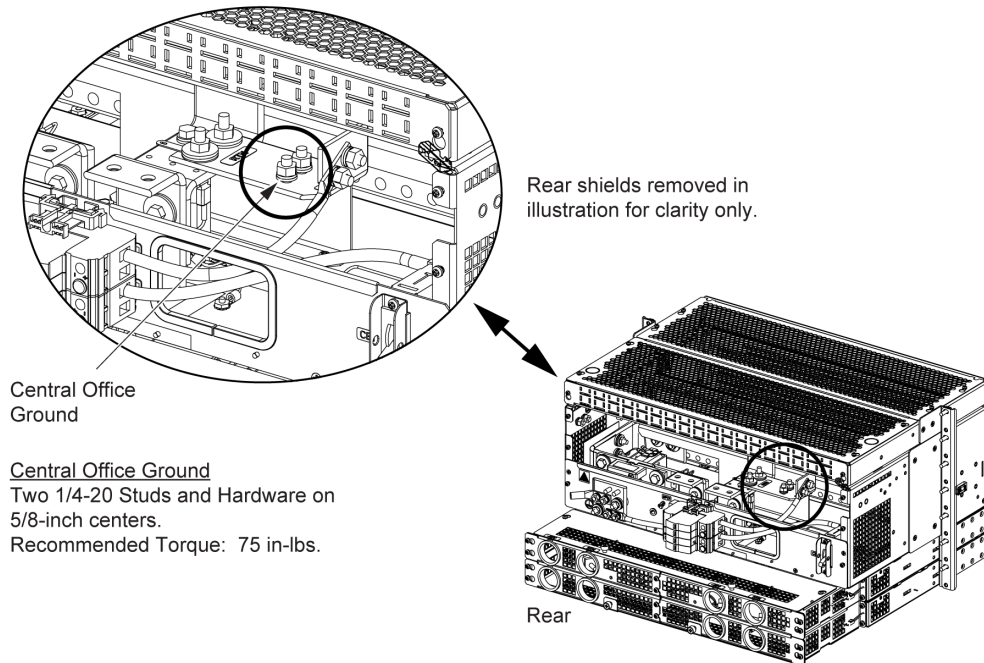

Figure 2
Central Office Ground Connection

SPD (Surge Protection Device) Earth Ground Connection

A set of studs and hardware are provided on a panel mounted on the rear of the DC distribution cabinet. This provides for the connection of an SPD (Surge Protection Device) earth ground lead with a two-hole lug that has 1/4" bolt clearance holes on 5/8" centers. A 2 AWG flex wire crimp lug is also provided with the system (two-hole lug, 1/4" bolt clearance holes on 5/8" centers). Connect an SPD (Surge Protection Device) earth ground lead to these studs. Refer to Figure 3 for location and recommended torque for this connection.

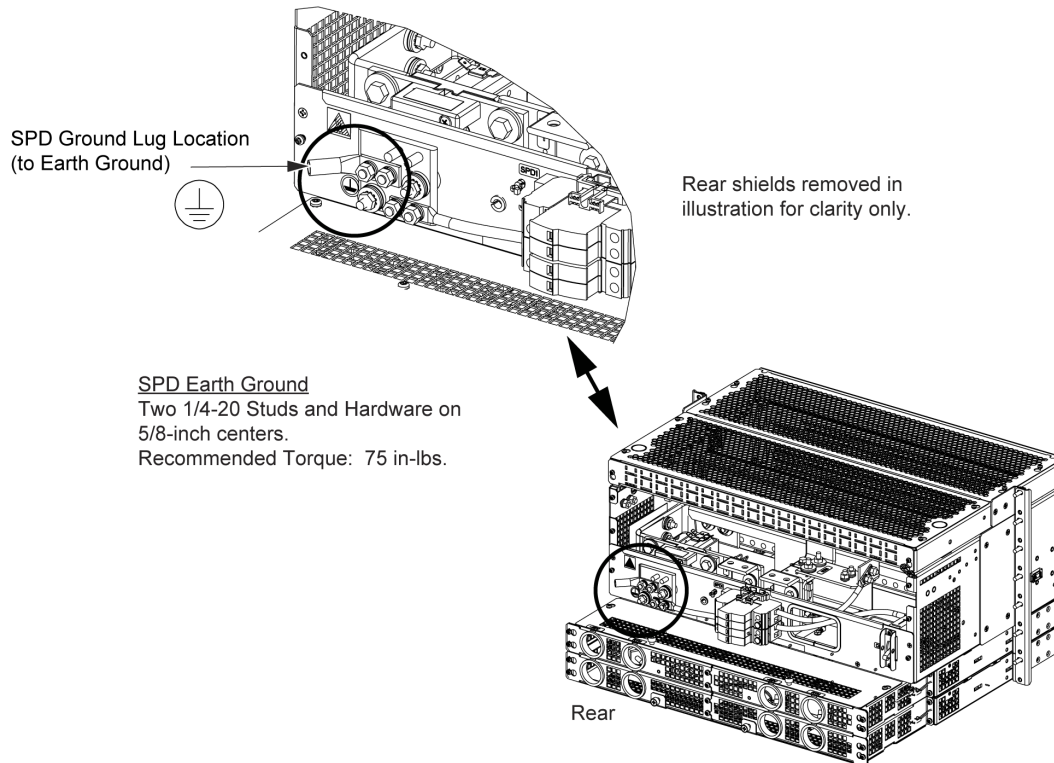

Figure 3
SPD (Surge Protection Device) Earth Ground Connection

-48 VDC Input Connections to Factory and Field Installed Converter Module Mounting Shelves

Description

Each converter module mounting shelf provides for connection of two (2) DC input feeds. Each DC input is internally connected to three (3) converter module mounting positions. Two (2) 1/4-20 studs on 5/8-inch centers are provided for each input (each polarity) for installation of customer provided DC input leads terminated in 2-hole lugs.

Converter Shelf Recommended DC Input Branch Circuit Protection, Wire Size, and Lug

DC input lugs must be ordered separately. Customer must also supply additional lug mounting hardware. For recommended wire sizes, branch circuit protection, and lugs, refer to Table 10. Lugs should be crimped per lug manufacturer's specifications. Maximum lug width is 1.12 inches. Maximum wire size is 4/0 AWG.

Converter Shelf Recommended DC Input Branch Circuit Protection, Wire Size, and Lug				
Each Converter Shelf Provides Input Terminations for Two (2) -48 VDC Feeds (One DC Feed per Three Converters)				
Input Voltage	Input Current	Overcurrent Protection ⁽¹⁾	40 °C Ambient Temperature	
			Wire ^{(1) (2)}	Recommended Lug ⁽³⁾
-48 VDC	108 A	150 A	1/0 AWG	116350

¹ Wire sizes based on recommendations of the American National Standards Institute (ANSI) approved National Fire Protection Association's (NFPA) National Electrical Code (NEC). Table 310.15 (B) (16) for copper wire at 90 °C conductor temperature. For operation at different ambient temperatures, follow applicable derating guidelines. For operation in countries where the NEC is not recognized, follow applicable codes.

² THHN 90°C Wire.

³ Two-hole lug, 1/4" bolt clearance hole, 5/8" centers. Lugs should be crimped per lug manufacturer's specifications.

Table 10
Converter Shelf Recommended DC Input Branch Circuit Protection, Wire Size, and Lug

Vertiv™ NetSure™ DCS48/58-600 Converter System

System Application Guide

-48 VDC Input Connections

Refer to Figure 4.

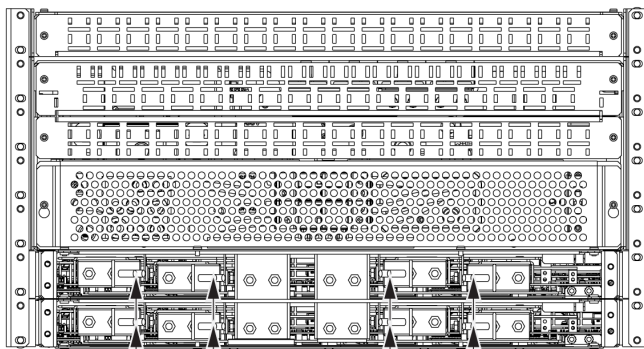
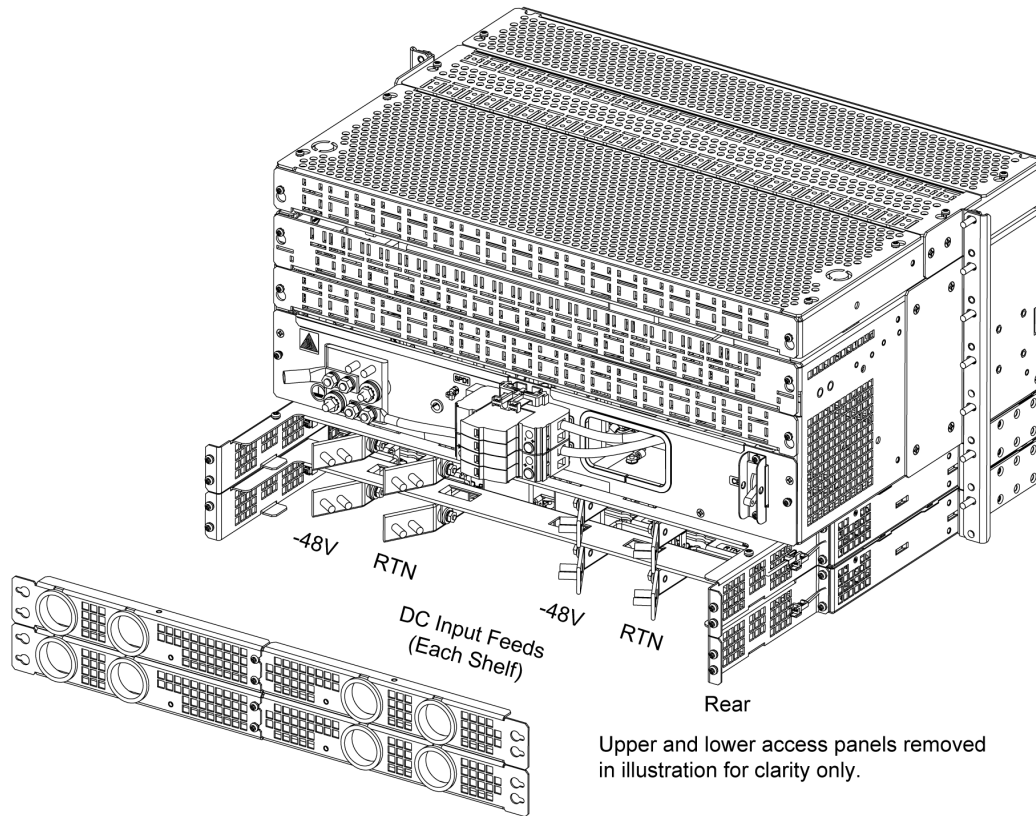

Rear
-48 VDC DC Input
 Two 1/4-20 Studs on 5/8-inch centers (each input, each polarity).

Recommended Torque:
 75 in-lbs. when using split lock washers.
 66 in-lbs. when using Belleville washers.
 (Customer must supply additional hardware.)

-48V Return **-48V Return**

Converter Mounting Positions #4, #5, #6 of the Respective Shelf Converter Mounting Positions #1, #2, #3 of the Respective Shelf

Converters are numbered #1 through #6 from left to right as viewed from the front of the shelf.

Figure 4
 -48 VDC Input Connections

-58 VDC Load Distribution Connections to Factory and Field Installed DC Distribution Cabinets

Load Distribution Wire Sizes and Lugs Selection

The rating of the distribution device determines the load lead wire size requirement. The type of DC distribution cabinet in the system (bullet nose type distribution devices or GJ/218 type circuit breakers) determines the lug hole size and spacing requirements. For wire size and lug selection, refer to the following.

- **When Distribution Cabinet using Bullet Nose Type Devices (TPS/TLS Fuses and/or Bullet Nose Type Circuit Breakers) are Provided:** Lug-terminated load leads are connected to the individual load busbars located on the distribution panel and to a separate return busbar located inside the distribution cabinet.

The distribution panel's individual load busbars and the distribution cabinet's load return busbar provide 1/4-20 studs for installation of customer-provided two-hole lugs that have 1/4-inch bolt clearance holes on 5/8-inch centers. Customer must provide additional lug mounting hardware. The distribution panel's individual load busbars and the distribution cabinet's load return busbar are designed to accommodate the lugs listed in Table 5 on page 22. Use Table 11 to select recommended load distribution wire sizes and lugs for various loop lengths per fuse/circuit breaker ampere rating. Maximum size of wire to be connected to a single fuseholder/circuit breaker position is 2 AWG. Refer also to "Busbar Lug Adapter Kits" on page 24.

When lug adapters P/N 559804 and 559805 are used, see Table 6 on page 23 for lug selection. Use Table 12 to select recommended load distribution wire sizes and lugs for various loop lengths per fuse/circuit breaker ampere rating.

- **When Distribution Cabinet using GJ/218 Circuit Breakers are Provided:** Lug-terminated load leads are connected to the individual load busbars and load return busbar located inside the distribution cabinet.

The distribution cabinet's individual load busbars and the load return busbar provide 3/8-16 studs for installation of customer-provided two-hole lugs that have 3/8-inch bolt clearance holes on 1-inch centers. Customer must provide additional lug mounting hardware. The distribution cabinet's individual load busbars and the load return busbar are designed to accommodate the lugs listed in Table 6 on page 23. Use Table 12 to select recommended load distribution wire sizes and lugs for various loop lengths per circuit breaker ampere rating.

Vertiv™ NetSure™ DCS48/58-600 Converter System

System Application Guide

Wire Size and Lug Selection Tables for Load Connections to TPS/TLS Fuses and Bullet Nose Type Circuit Breakers

Fuse/ Circuit Breaker Amperage	Recm 90°C Wire Size ⁽¹⁾							
	14 AWG	12 AWG	10 AWG	8 AWG	6 AWG	4 AWG	2 AWG	1/0 AWG
	Loop Length (feet) ⁽²⁾							
1, 3, 5, 6, 10 A	37 ^(3,4,5)	58 ^(3,4,5)	93 ^(3,4,5)	148 ^(3,4,5)	236 ^(3,4,5)	376 ^(3,4,5)	597 ^(3,4,5)	--
15 A	24 ^(3,4)	39 ^(3,4,5)	62 ^(3,4,5)	99 ^(3,4,5)	157 ^(3,4,5)	250 ^(3,4,5)	398 ^(3,4,5)	--
20 A	--	29 ^(3,4)	46 ^(3,4,5)	74 ^(3,4,5)	118 ^(3,4,5)	188 ^(3,4,5)	298 ^(3,4,5)	--
25 A	--	--	37 ^(3,4)	59 ^(3,4,5)	94 ^(3,4,5)	150 ^(3,4,5)	239 ^(3,4,5)	--
30 A	--	--	31 ^(3,4)	49 ^(3,4,5)	78 ^(3,4,5)	125 ^(3,4,5)	199 ^(3,4,5)	--
35 A	--	--	--	42 ^(3,4)	67 ^(3,4,5)	107 ^(3,4,5)	170 ^(3,4,5)	--
40 A	--	--	--	37 ^(3,4)	59 ^(3,4,5)	94 ^(3,4,5)	149 ^(3,4,5)	--
45 A	--	--	--	33 ^(3,4)	52 ^(3,4)	83 ^(3,4)	132 ^(3,4)	--
50 A	--	--	--	29 ^(3,4)	47 ^(3,4)	75 ^(3,4)	119 ^(3,4)	--
60 A	--	--	--	--	39 ^(3,4)	62 ^(3,4)	99 ^(3,4)	--
70 A	--	--	--	--	33 ⁽³⁾	53 ^(3,4)	85 ^(3,4)	135 ⁽⁴⁾
75 A	--	--	--	--	31 ⁽³⁾	50 ^(3,4)	79 ^(3,4)	126 ⁽⁴⁾
80 A	--	--	--	--	--	47 ^(3,4)	74 ^(3,4)	118 ^(3,4)
Recommended Crimp Lug								
Lug	245342300 ⁽⁶⁾	245342300 ⁽⁶⁾	245342300 ⁽⁶⁾	245390200 ⁽⁶⁾	245346700 ⁽⁶⁾	245346800 ⁽⁶⁾	245346900 ⁽⁶⁾	116350 ⁽⁶⁾
Fuse/ Circuit Breaker Amperage	Recm 90°C Wire Size ⁽¹⁾							
	4 AWG	2 AWG	1/0 AWG	2/0 AWG	3/0 AWG	4/0 AWG	250 kcmil	350 kcmil
	Loop Length (feet) ⁽²⁾							
90 A	41 ⁽³⁾	66 ^(3,4)	105 ^(3,4)	133 ⁽⁴⁾	--	--	--	--
100 A	--	59 ^(3,4)	95 ^(3,4)	119 ^(3,4)	--	--	--	--
125 A	--	47 ⁽³⁾	76 ^(3,4)	95 ^(3,4)	120 ⁽⁴⁾	--	--	--
150 A	--	--	63 ^(3,4)	79 ^(3,4)	100 ^(3,4)	--	--	--
200 A	--	--	--	--	75 ^(3,4)	95 ^(3,4)	112 ^(3,4)	--
250 A	--	--	--	--	--	76 ^(3,4)	90 ^(3,4)	126 ^(3,4)
300 A	--	--	--	--	--	--	--	105 ^(3,4)
Recommended Crimp Lug								
Lug	245346800 ⁽⁶⁾	245346900 ⁽⁶⁾	116350 ⁽⁶⁾	119213 ⁽⁶⁾	--	118331 ⁽⁶⁾	--	--

- 1 Wire sizes based on recommendations of the American National Standards Institute (ANSI) approved National Fire Protection Association's (NFPA) National Electrical Code (NEC). Table 310.15 (B) (16) for copper wire at 90 °C conductor temperature. For operation in countries where the NEC is not recognized, follow applicable codes.
- 2 Recommended wire sizes are sufficient to restrict voltage drop to 1.0 volt or less at listed branch current for the loop lengths shown. Loop length is the sum of the lengths of the positive and negative leads.
- 3 Wire Size / Loop Length Combination Calculated using 30 °C Ambient Operating Temperature.
- 4 Wire Size / Loop Length Combination Calculated using 40 °C Ambient Operating Temperature.
- 5 Wire Size / Loop Length Combination Calculated using 65 °C Ambient Operating Temperature.
- 6 Two-hole lug, 1/4" bolt clearance hole, 5/8" centers. Lugs should be crimped per lug manufacturer's specifications.

Table 11
Recommended Wire Sizes and Lugs for Load Connections
to Various TPS/TLS Fuses and Bullet Nose Type Circuit Breakers

Vertiv™ NetSure™ DCS48/58-600 Converter System

System Application Guide

Wire Size and Lug Selection Tables for Load Connections to GJ/218 Type Circuit Breakers and TPS/TLS Fuses and Bullet Nose Type Circuit Breakers when Used with Load Lug Adapters P/N 559804 and 559805

Fuse/ Circuit Breaker Amperage	Recm 90°C Wire Size ⁽¹⁾							
	6 AWG	4 AWG	2 AWG	1/0 AWG	2/0 AWG	3/0 AWG	4/0 AWG	250 kcmil
	Loop Length (feet) ⁽²⁾							
70 A	33 ⁽³⁾	53 ^(3,4)	85 ^(3,4)	135 ⁽⁴⁾	--	--	--	--
80 A	--	47 ^(3,4)	74 ^(3,4)	118 ^(3,4)	--	--	--	--
100 A	--	--	59 ^(3,4)	95 ^(3,4)	119 ^(3,4)	--	--	--
125 A	--	--	47 ⁽³⁾	76 ^(3,4)	95 ^(3,4)	120 ⁽⁴⁾	--	--
150 A	--	--	--	63 ^(3,4)	79 ^(3,4)	100 ^(3,4)	--	--
175 A	--	--	--	--	68 ^(3,4)	86 ^(3,4)	108 ^(3,4)	--
200 A	--	--	--	--	--	75 ^(3,4)	95 ^(3,4)	112 ^(3,4)
	Recommended Crimp Lug ⁽⁵⁾							
Lug	245349900	245350000	245348200	245347100	245347200	245347300	245347400	245347500
Fuse/ Circuit Breaker Amperage	Recm 90°C Wire Size ⁽¹⁾							
	2/0 AWG	3/0 AWG	4/0 AWG	250 kcmil	300 kcmil	350 kcmil	400 kcmil	500 kcmil
	Loop Length (feet) ⁽²⁾							
225 A	--	67 ⁽³⁾	84 ^(3,4)	100 ^(3,4)	120 ⁽⁴⁾	--	--	--
250 A	--	--	76 ⁽³⁾	90 ^(3,4)	108 ^(3,4)	126 ⁽⁴⁾	--	--
300 A	159 ⁽⁴⁾ (2) Wires	--	--	--	90 ⁽³⁾	105 ^(3,4)	120 ^(3,4)	--
400 A	--	75 ^(3,4) (2) Wires	95 ^(3,4) (2) Wires	112 ^(3,4) (2) Wires	--	--	--	--
500 A	--	--	76 ⁽³⁾ (2) Wires	90 ^(3,4) (2) Wires	108 ^(3,4) (2) Wires	126 ⁽⁴⁾ (2) Wires	--	--
600 A	--	--	--	--	90 ⁽³⁾ (2) Wires	105 ^(3,4) (2) Wires 157 ⁽⁴⁾ (3) Wires	120 ^(3,4) (2) Wires	--
800 A	--	--	--	84 ⁽³⁾ (3) Wires	101 ^(3,4) (3) Wires	118 ^(3,4) (3) Wires	135 ^(3,4) (3) Wires	--
	Recommended Crimp Lug ⁽⁵⁾							
Lug	245347200 (per cable)	245347300 (per cable)	245347400 (per cable)	245347500 (per cable)	245347600 (per cable)	245347700 (per cable)	245347800 (per cable)	245347900 (per cable)

- Wire sizes based on recommendations of the American National Standards Institute (ANSI) approved National Fire Protection Association's (NFPA) National Electrical Code (NEC). Table 310.15 (B) (16) for copper wire at 90 °C conductor temperature. For operation in countries where the NEC is not recognized, follow applicable codes.
- Recommended wire sizes are sufficient to restrict voltage drop to 1.0 volt or less at listed branch current for the loop lengths shown. Loop length is the sum of the lengths of the positive and negative leads.
- Wire Size / Loop Length Combination Calculated using 30 °C Ambient Operating Temperature.
- Wire Size / Loop Length Combination Calculated using 40 °C Ambient Operating Temperature.
- Two-hole lug, 3/8" bolt clearance hole, 1" centers. Lugs should be crimped per lug manufacturer's specifications.

Table 12
Recommended Wire Sizes and Lugs for Load Connections to Various GJ/218-Circuit Breakers and TPS/TLS Fuses and Bullet Nose Type Circuit Breakers when Used with Load Lug Adapters P/N 559804 and 559805

-58 VDC Load Distribution Connections to TPS/TLS Fuses and Bullet Nose Type Circuit Breaker Positions

Refer to Figure 5.

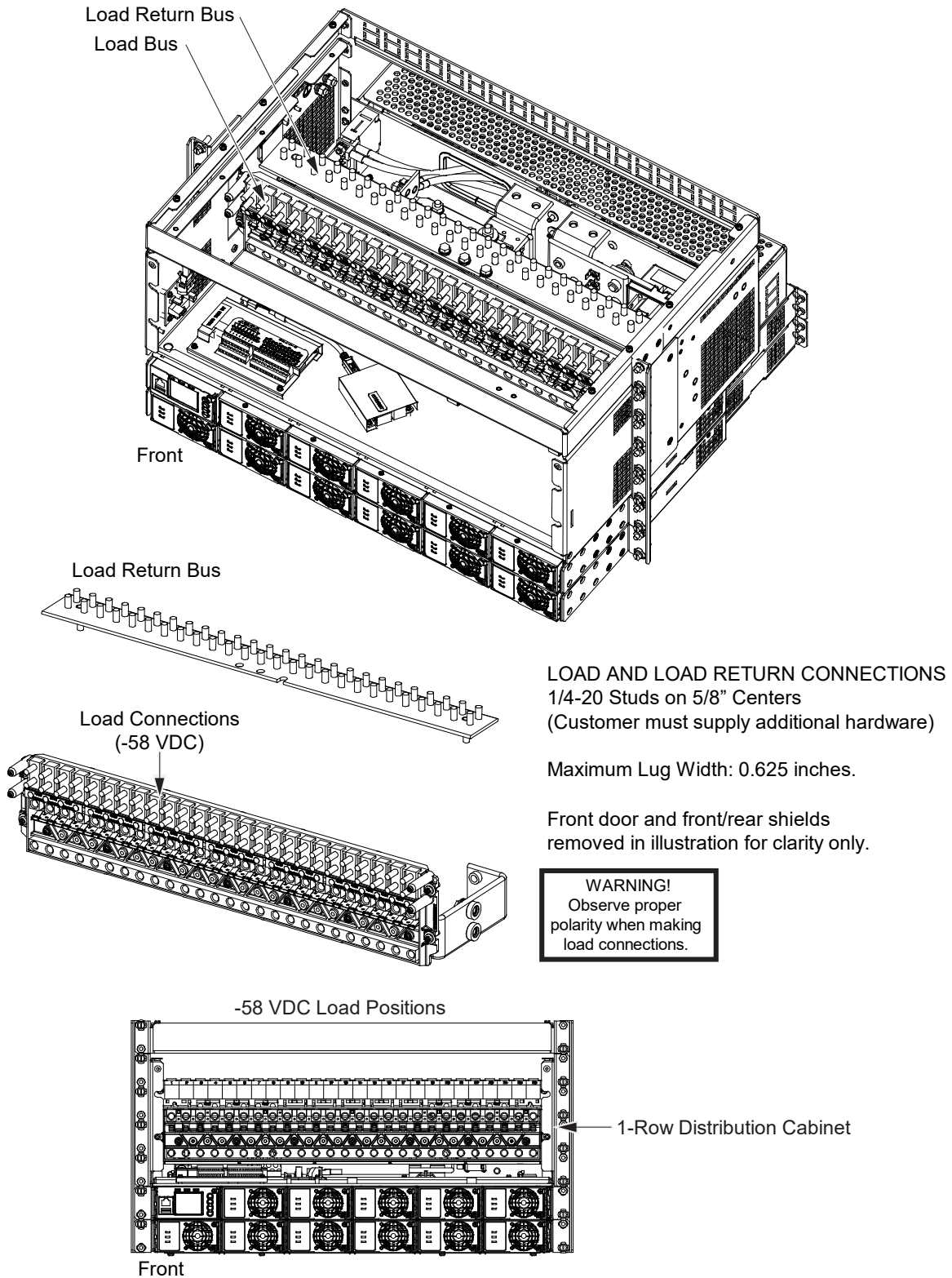

Figure 5

-58 VDC Load Distribution Connections to TPS/TLS Fuses and Bullet Nose Type Circuit Breaker Positions

Vertiv™ NetSure™ DCS48/58-600 Converter System

System Application Guide

-58 VDC Load Distribution Connections to GJ/218 Circuit Breaker Positions

Refer to Figure 6.

LOAD AND LOAD RETURN CONNECTIONS
 3/8-16 Studs on 1" Centers
 (Customer must supply additional hardware)

Maximum Lug Width: 1.375 inches.

Front door and front/rear shields removed in illustration for clarity only.

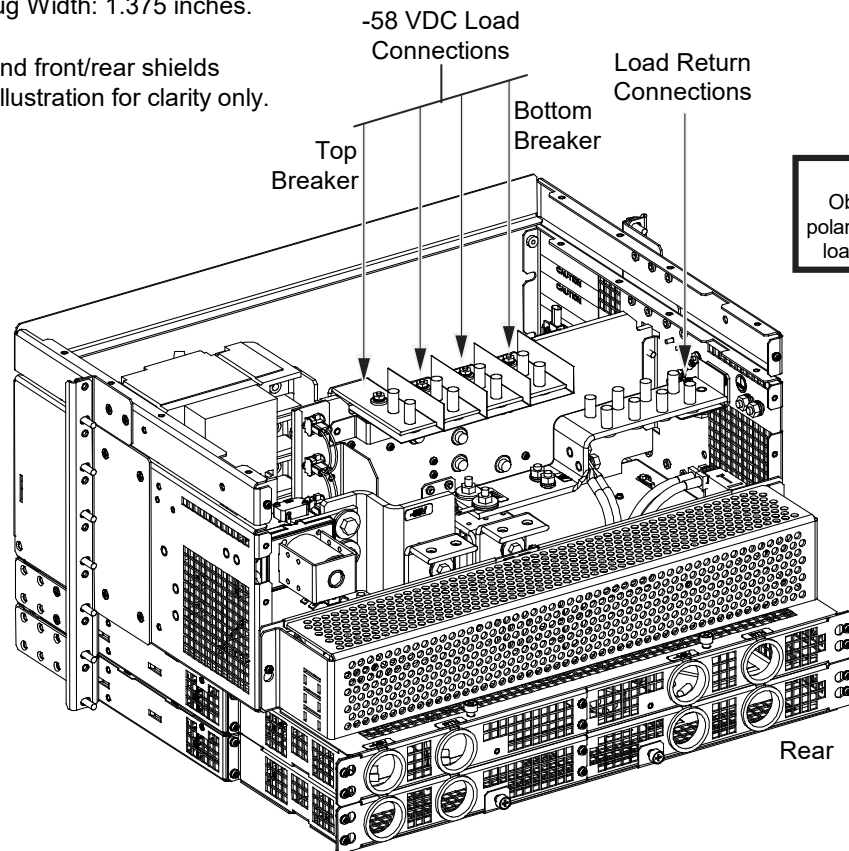

WARNING!
 Observe proper polarity when making load connections.

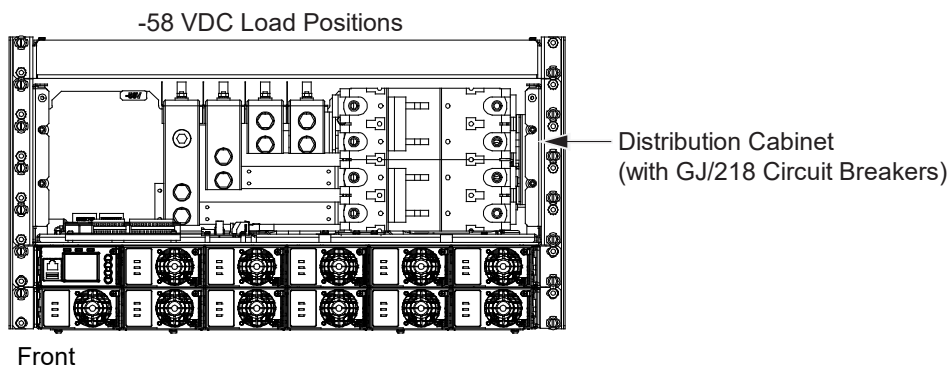

Figure 6
 -58 VDC Load Distribution Connections to GJ/218 Circuit Breaker Positions

Load Distribution Wiring (Optional Bullet Nose 6-Position GMT Fuse Block)

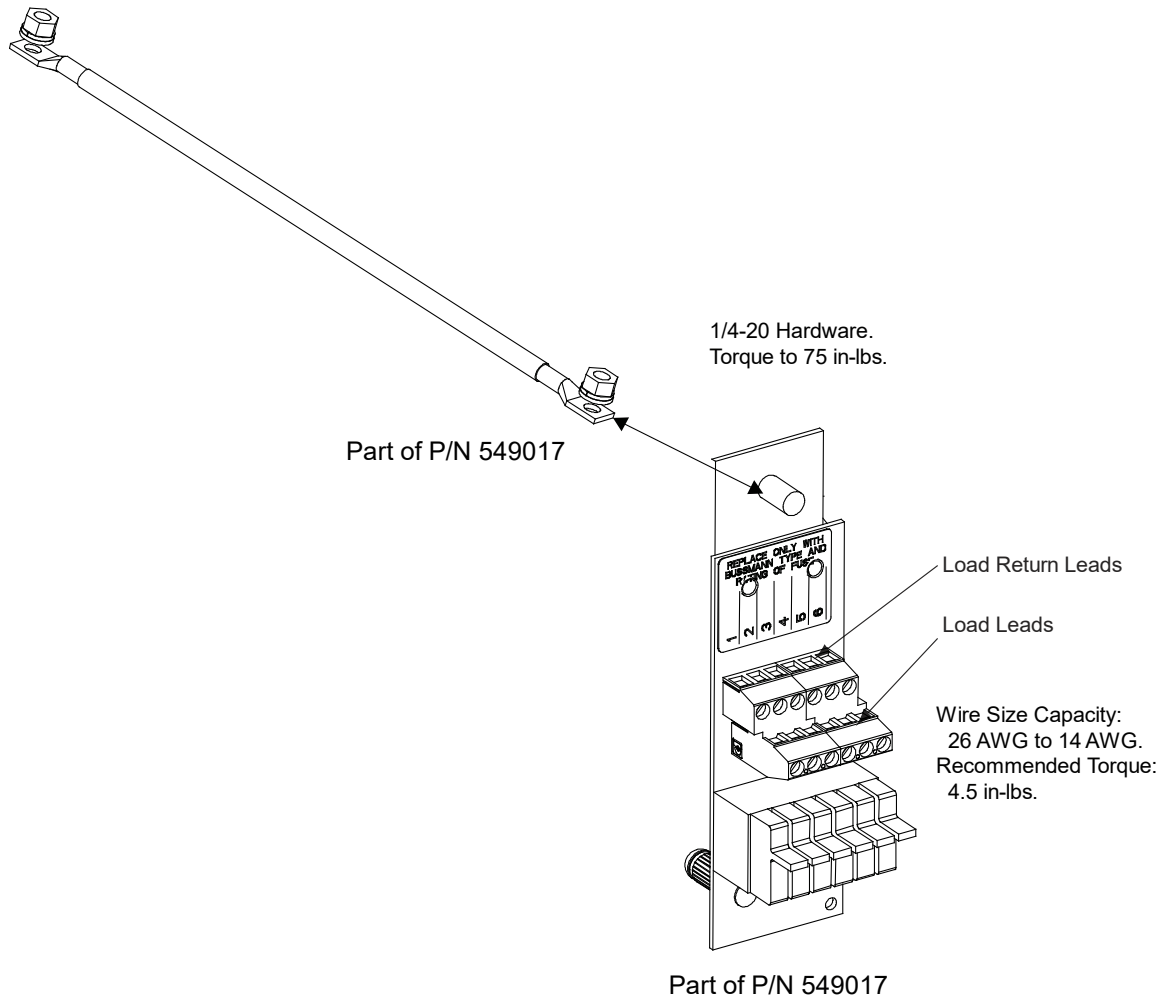

Figure 7
Load Distribution Wiring (Optional Bullet Nose 6-Position GMT Fuse Block)

External Alarm, Reference, Monitoring, and Control Connections

General

Recommended wire size is 22 AWG for loop lengths up to 200 ft. and 18 AWG to 20 AWG for loop lengths over 200 ft.

External Alarm, Reference, Monitoring, and Control Connections Locations

Refer to Figure 8.

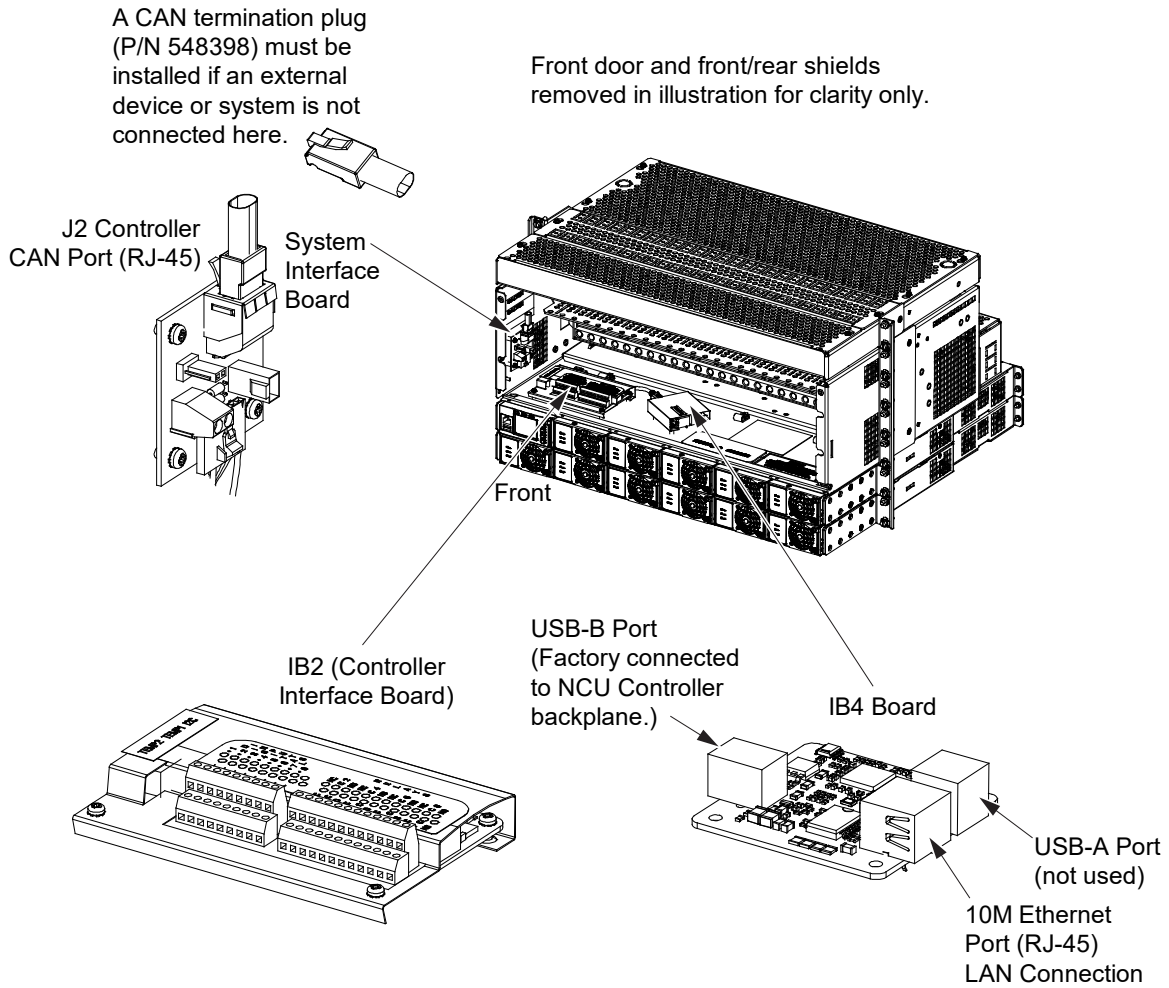

Figure 8
External Alarm, Reference, Monitoring, and Control Connections Locations

Vertiv™ NetSure™ DCS48/58-600 Converter System

System Application Guide

IB2 (Controller Interface Board)

Refer to Figure 9.

The relay assigned to “Critical Summary” alarm (relay 1 by default) will operate in the “Fail Safe Mode”. “Fail Safe Mode” means Relay 1 is de-energized during an alarm condition, opening the contacts between the C and NO terminals, and closing the contacts between the C and NC terminals. The remaining seven (7) relays energize during an alarm condition, closing the contacts between the C and NO terminals, and opening the contacts between the C and NC terminals.

Not all I/O points may be available for customer connection (some may be used for factory system connections). The digital inputs and relay outputs may be preprogrammed for specific functions. Refer to the configuration drawing (C-drawing) supplied with your system for your system’s specific configuration.

J3-J9:

Wire Size Capacity: 16 AWG to 26 AWG.

Wire Strip Length: 0.20 inch.

Recommended Torque: 2.2 in-lbs.

IB2 Assembly (with shield)

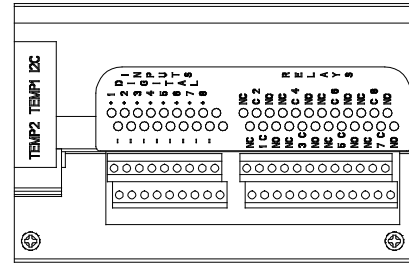

Switch settings must be in this position to interface with the controller.

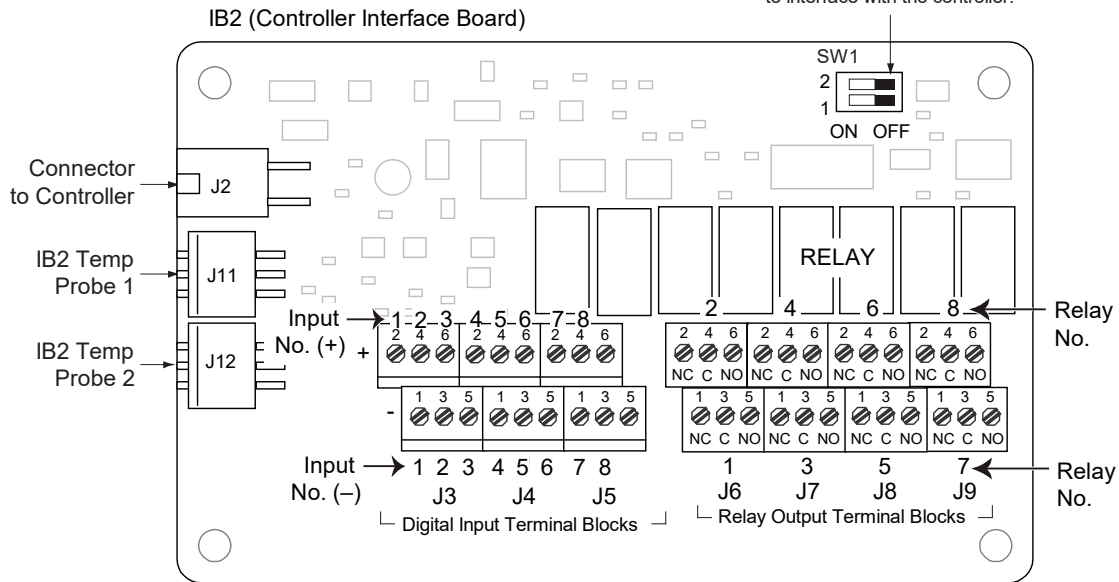

Schematic Diagram of IB2 (Controller Interface Board)

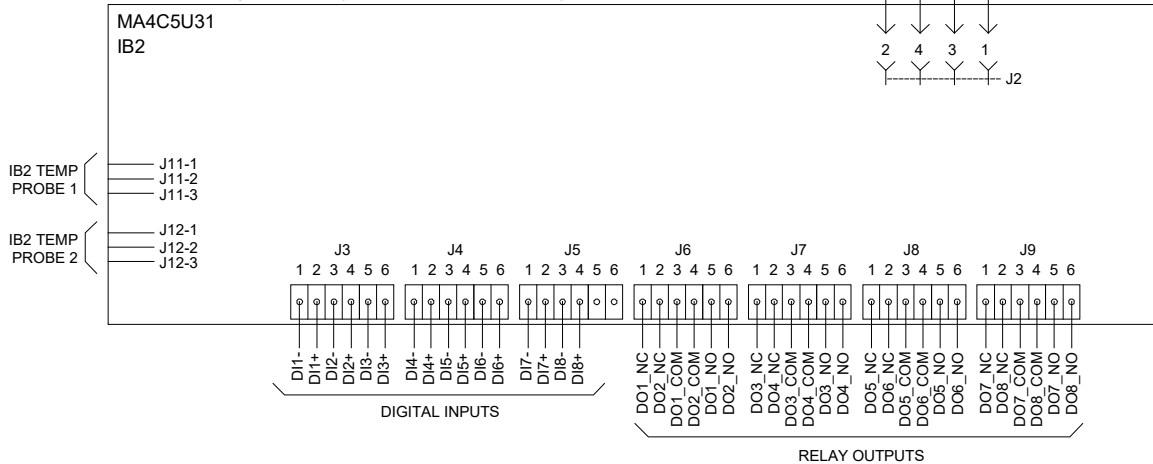

Figure 9
External Alarm, Reference, Monitoring, and Control Connections, IB2 (Controller Interface Board)

Vertiv™ NetSure™ DCS48/58-600 Converter System

System Application Guide

System Interface Board

Refer to Figure 10.

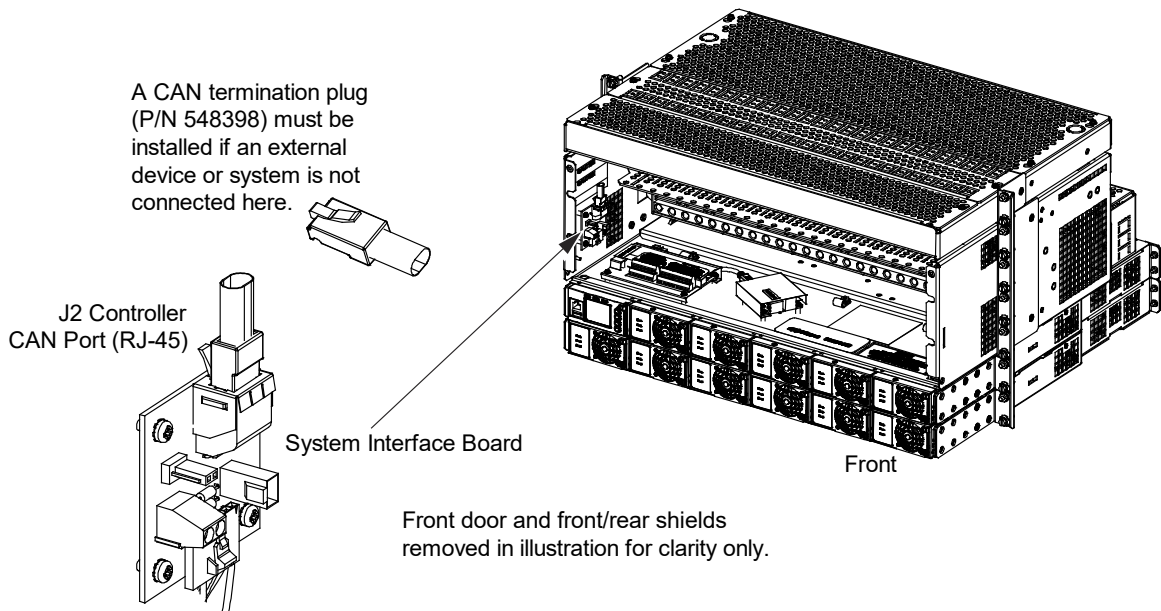

System Interface Board P/N 555484

J4 on System Interface Board
No Function In This System
Leave in Default Position

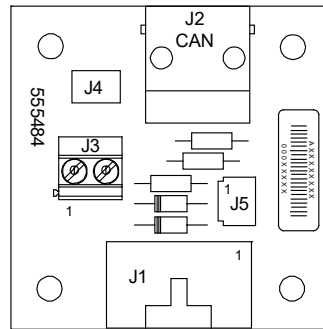
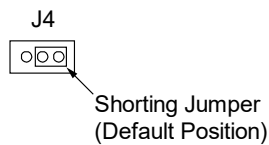

J3 on System Interface Board
Wire Size Capacity: 16 AWG to 30 AWG.
Wire Strip Length: 0.32 inch.
Recommended Torque: 2.3 in-lbs.

RS485 Connection

J3-1: RS485+
J3-2: RS485-

Figure 10

External Alarm, Reference, Monitoring, and Control Connections, System Interface Board

NCU Controller Ethernet Connection

The controller provides a Web Interface via an Ethernet connection to a TCP/IP network. This interface can be accessed locally on a computer and/or remotely through a network. The system has two Ethernet ports. One located on the NCU front panel and the other located on the IB4 board. The function of these Ethernet ports are as follows.

NCU Front Panel Ethernet Port

An RJ-45 10BaseT jack is provided on the front of the controller for connecting a computer directly to the NCU. This jack has a standard Ethernet pin configuration scheme, twisted pair. Refer to Figure 11 for location. Refer to the NCU Instructions (UM1M830BNA) for operational details.

Note: DO NOT connect your Local Area Network (LAN) to the NCU front Ethernet port.

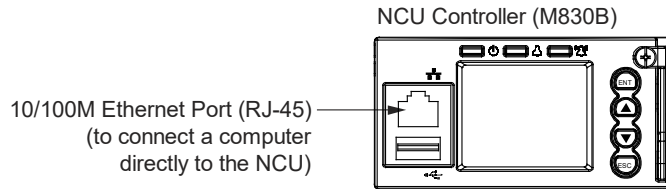

Figure 11
NCU Ethernet Port
(for connecting a computer directly to the NCU)

IB4 Board Ethernet Port

An RJ-45 10BaseT jack is provided on the IB4 board for connection into a customer's network. Use this Ethernet port to connect the NCU to your Local Area Network (LAN). This jack has a standard Ethernet pin configuration scheme, twisted pair. Refer to Figure 12 for IB4 board and Ethernet port location. Use shielded Ethernet cable (grounded at both ends). Note that the IB4 board's RJ-45 jack is connected to chassis ground. Refer to the NCU Instructions (UM1M830BNA) for operational details.

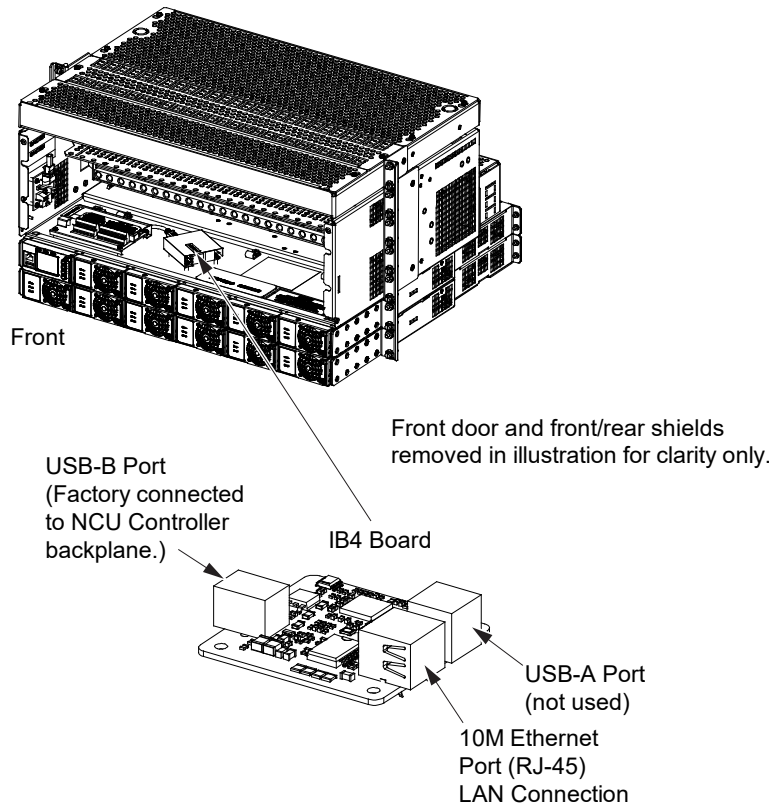

Figure 12
IB4 Board Ethernet Port
(for connection into a customer's network)

SPECIFICATIONS

1. SYSTEM

1.1 Output Ratings

1.1.1 See “General Converter Systems Specifications” starting on page 2.

1.2 Input Ratings

1.2.1 See “General Converter Systems Specifications” starting on page 2.

1.3 Environmental Ratings

1.3.1 Operating Ambient Temperature Range: -40°C to +65°C (-40°F to +149°F).

1.3.2 Storage Ambient Temperature Range: -40 °C to +85 °C (-40 °F to +185 °F).

1.3.3 Relative Humidity: This Converter System is capable of operating in an ambient relative humidity range of 0% to 95%, non-condensing.

1.3.4 Altitude: Capable of operating in an altitude range of -200 feet to 10,000 feet. The maximum operating ambient temperature should be de-rated by 3°C per 1000 feet above 6562 feet.

1.3.5 Audible Noise: With variable fan speed enabled, less than 56 dBA with 11 converters in the system at ≤25 °C, measured at 1 meter distance in front of the system and at the same horizontal line as the middle of the system.

1.3.6 EMI/RFI Suppression:

(A) The system has been tested to FCC Part 15 Subpart B, GR-1089 and EN 55032 Class B radiated emissions limits.

(B) The system has been tested to the GR-1089 conducted emission limits for DC Power Ports (Input / Output) and Ethernet / Signal Leads.

(C) The system has been tested to the EN 55032 Class A limits for conducted emissions for DC Power Ports (Inputs).

This equipment has been tested and found to comply with the limits for a Class B digital device, pursuant to Part 15, Subpart B of the FCC Rules. These limits are designed to provide reasonable protection against harmful interference when the equipment is operated in a residential environment. This equipment generates, uses and can radiate radio frequency energy and, if not installed and used in accordance with the instruction manual, may cause harmful interference to radio communications. However, there is no guarantee that interference will not occur in a particular installation. If this equipment does cause harmful interference to radio or television reception, which can be determined by turning the equipment off and on, the user is encouraged to try and correct the interference by one or more of the following measures.

(A) Reorient or relocate the receiving antenna.

(B) Increase the separation between the equipment and receiver.

(C) Connect the equipment into an outlet on a circuit different from that to which the receiver is connected.

1.3.7 Mounting: This converter system is designed to mount in a standard 23” relay rack or equipment rack having 1” or 1-3/4” multiple drillings. Refer to “Overall Dimensions” on page 44 for mounting dimensions.

- This product is recommended to be installed in a restricted access location on or above a non-combustible surface.
- This product is recommended to be located in a controlled environment with access to crafts persons only.
- This product is intended for installation in network telecommunication facilities (CO, vault, hut, or other environmentally controlled electronic equipment enclosure).
- This product is intended to be connected to the common bonding network in a network telecommunication facility (CO, vault, hut, or other environmentally controlled electronic equipment enclosure).
- The DC return connection to this system can remain isolated from system frame and chassis (DC-I).
- This system is suitable for installation as part of the Common Bonding Network (CBN).
- The system must be mounted in an environment that does not exceed the Operating Ambient Temperature Range stated above.

Vertiv™ NetSure™ DCS48/58-600 Converter System

System Application Guide

- Clearance requirements are as follows.
 - Recommended minimum aisle space clearance for the front of each bay is 2' 6".
 - Recommended minimum aisle space clearance for the rear of each bay is 2' 0" for any of the following conditions:
 - Addition of a module mounting assembly in the field.
 - Making input connections to a field installed module mounting assembly.
 - For all other conditions:
 - For rear entry and **rear bending** of -48 VDC input feed cables, required minimum spacing from the **rear** of the input feed box to a wall or other solid structure must not be less than seven (7) inches for 4/0 TelcoFlex wire; or as determined by wire bending requirements for the actual wire size used at the site.
 - For rear entry and **side bending** of -48 VDC input feed cables, required minimum spacing is:
 - from the **rear** of the input feed box to a **rear** wall or other solid structure must not be less than five (5) inches for 4/0 TelcoFlex wire;
 - from the **side** of the input feed box to a **side** wall or other solid structure must not be less than five (5) inches for 4/0 TelcoFlex wire;
 - or as determined by wire bending requirements for the actual wire size used at the site.
 - Required minimum spacing from the **front** of the system must not be less than four (4) inches. (This will assure proper airflow through the converter modules.)
- Note:** *Minimum spacing specified for ventilation and wire bending may not permit replacement of certain components such as busbars or module mounting assemblies.*

1.4 Compliance Information

1.4.1 Safety Compliance:

- (A) UL 62368-1, 2nd Ed, 2014-12-01 (Audio/video, information and communication technology equipment Part 1: Safety requirements).
- (B) CAN/CSA C22.2 No. 62368-1-14, 2nd Ed (Audio/video, information and communication technology equipment Part 1: Safety requirements).

1.4.2 NEBS Compliance: Meets customer-specific Level 1 NEBS Equivalency to the relevant sections of GR-1089-CORE and GR-63-CORE.

Converter Modules: In order to remain compliant during a fan failure condition, the system must operate with a redundant module installed.

1.5 IB2 (Controller Interface Board) Ratings

1.5.1 Digital Input Ratings

- (A) Maximum Voltage Rating: 60 VDC.
- (B) Active High: > 19 VDC.
- (C) Active Low: < 1 VDC.

1.5.2 Relay Ratings

- (A) Steady State: 0.5 A @ 60 VDC, 1 A @ 30 VDC.
- (B) Peak: 3 A @ 30 VDC.

2. -48 VDC TO -58 VDC CONVERTER

2.1 Refer to the Converter Instructions (UM1C48582000P3).

3. CONTROLLER

3.1 Refer to the NCU Controller Instructions (UM1M830BNA).

3.2 For controller factory settings, refer to the Controller Configuration Drawing (C-drawing).

MECHANICAL SPECIFICATIONS

Overall Dimensions

584641000 List 01, List 02, List 03, List 04

- Notes:
 1. All dimensions are in inches.
 2. Finish: Textured Gray.

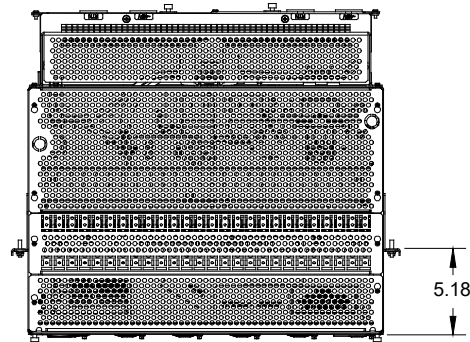

Top View

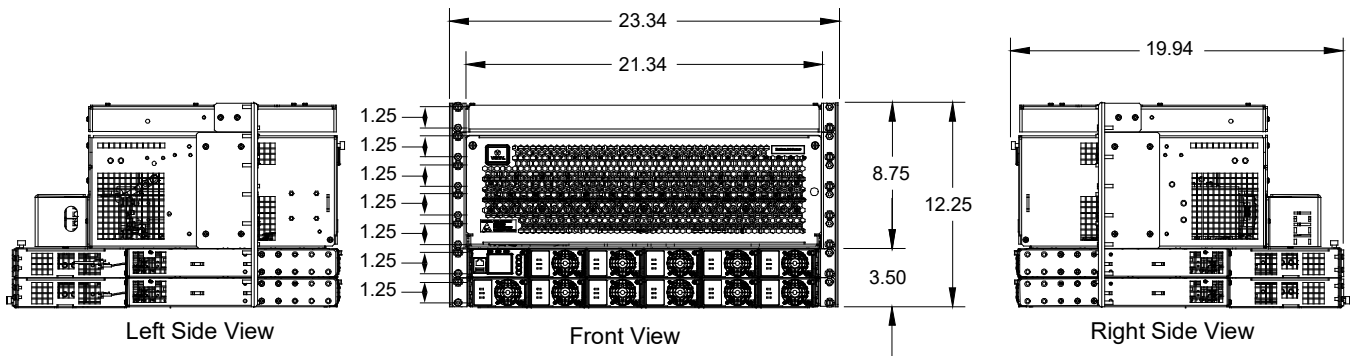

Left Side View

Front View

Right Side View

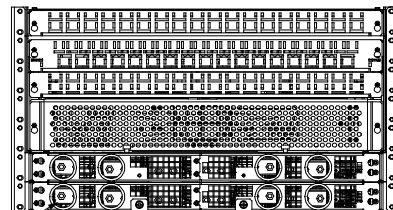

Rear View

Diam. 1.5
 (8) places

Vertiv™ NetSure™ DCS48/58-600 Converter System

System Application Guide

584641000 List 01, List 02, List 03, List 04 (with Expansion DC Distribution Cabinet)

Notes:
 1. All dimensions are in inches.
 2. Finish: Textured Gray.

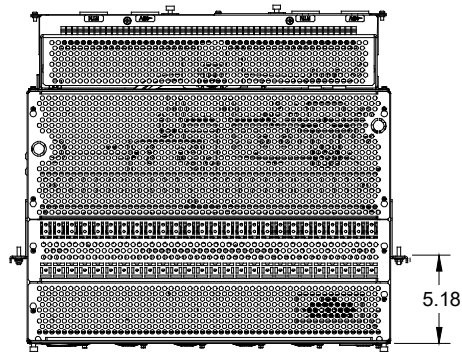

Top View

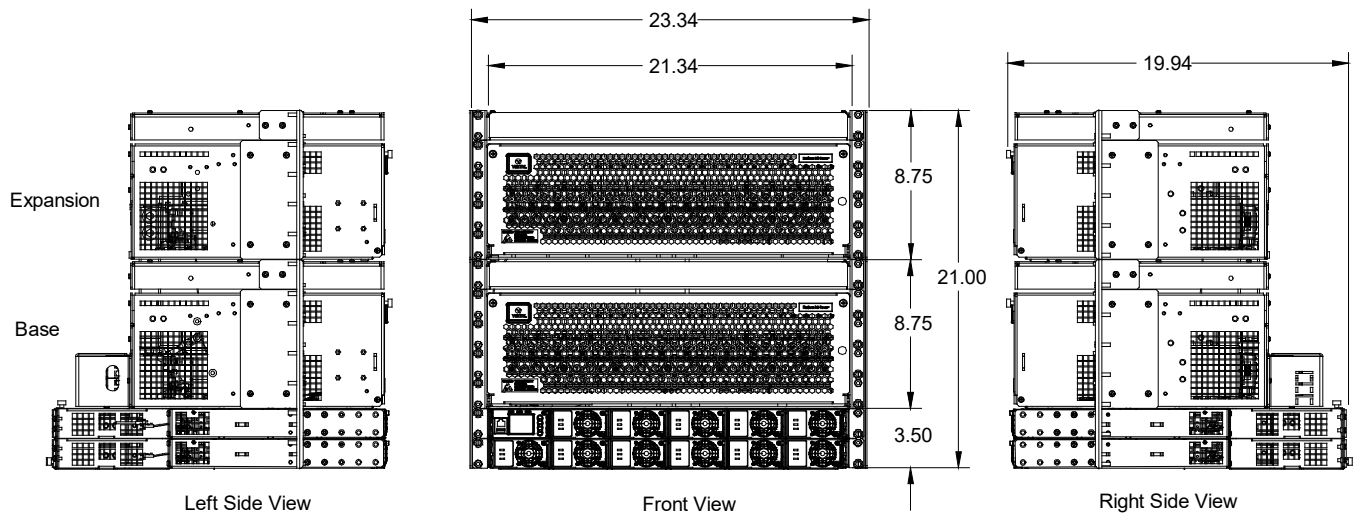

Left Side View

Front View

Right Side View

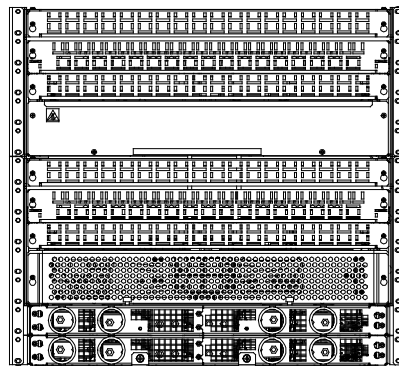

Rear View

Vertiv™ NetSure™ DCS48/58-600 Converter System

System Application Guide

584641000 List 10

Notes:
1. All dimensions are in inches.

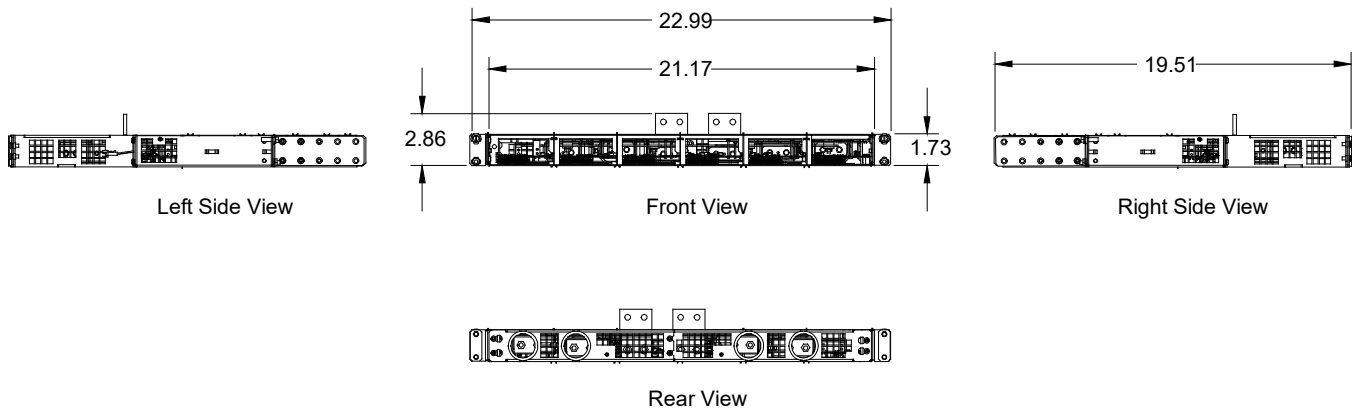
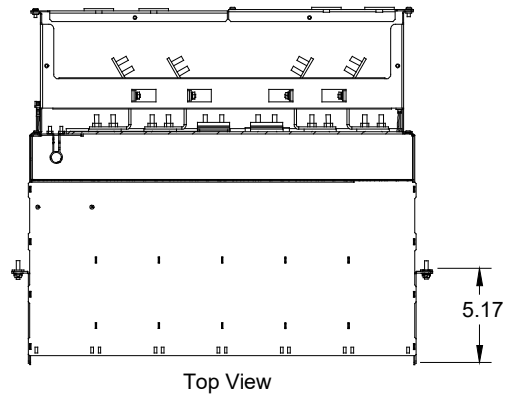

Vertiv™ NetSure™ DCS48/58-600 Converter System

System Application Guide

584641000 List AL and List CL

Notes:

1. All dimensions are in inches.
2. Finish: Textured Gray.

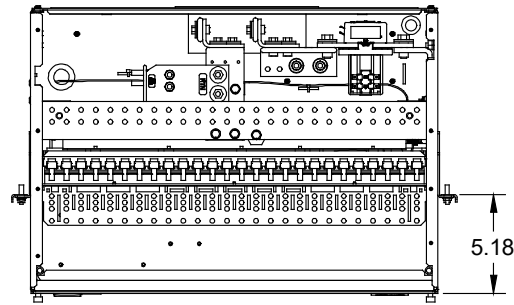

Top View

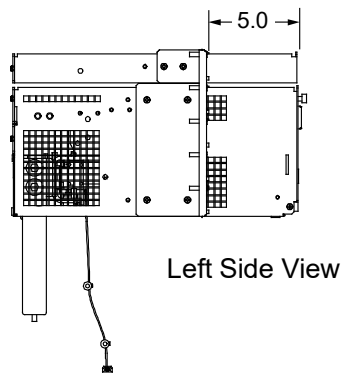

Left Side View

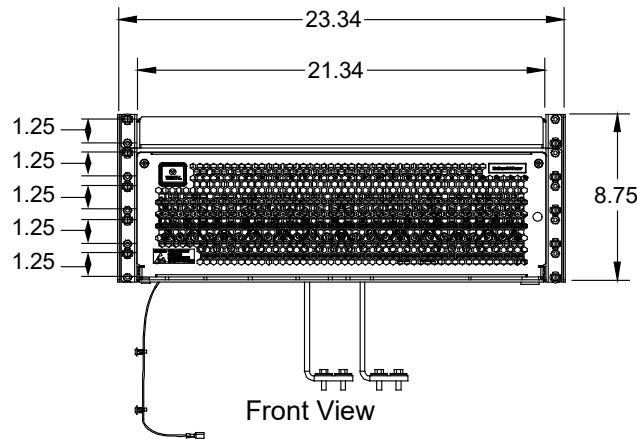

Front View

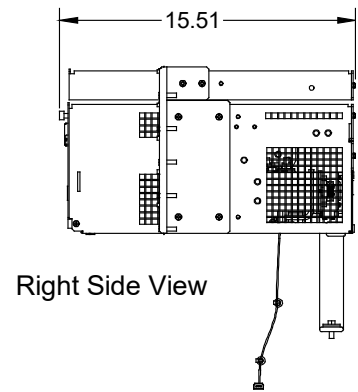

Right Side View

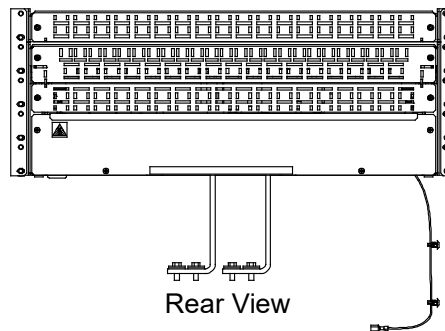

Rear View

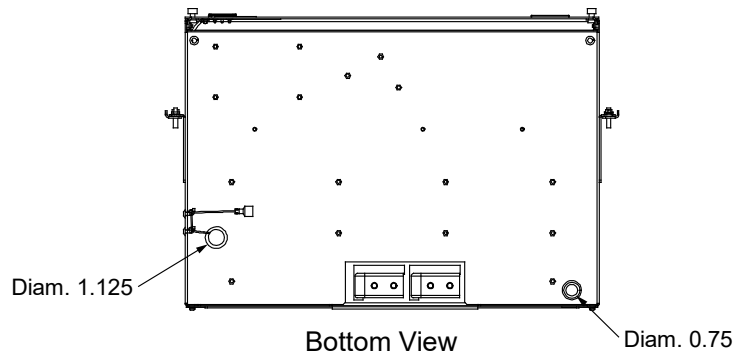

Bottom View

Vertiv™ NetSure™ DCS48/58-600 Converter System

System Application Guide

Weights

List Number or Part Number	Net Weight (lbs), each	Description
Base Equipment (One Distribution Cabinet, Two Module Mounting Shelves)		
58464100001	80.9	Converter System, -48 VDC to -58 VDC, 400A, (26) Bullet-Type Distribution Positions, w/o Load Disconnect Contactor
58464100002	83.2	Converter System, -48 VDC to -58 VDC, 400A, (26) Bullet-Type Distribution Positions, with Load Disconnect Contactor
58464100003	80.9	Converter System, -48 VDC to -58 VDC, 600A, (4) GJ/218 Circuit Breaker Positions, w/o Load Disconnect Contactor
58464100004	83.2	Converter System, -48 VDC to -58 VDC, 600A, (4) GJ/218 Circuit Breaker Positions, with Load Disconnect Contactor
Expansion Module Mounting Shelf		
58464100010	14.0	Expansion Module Mounting Shelf
Expansion Distribution Cabinet (Twenty-Six Bullet-Type Distribution Positions)		
584641000AL	54.0	Expansion Distribution Cabinet, (26) Bullet-Type Distribution Positions, w/o Load Disconnect Contactor
584641000CL	56.3	Expansion Distribution Cabinet, (26) Bullet-Type Distribution Positions, with Load Disconnect Contactor
Converter Module		
1C48582000P3	2.3	Converter Module
Controller		
1M830BNA	1.0	NCU Controller

RELATED DOCUMENTATION

Installation and User Instructions:	UM584641000
NCU Controller Instructions:	UM1M830BNA
Converter Instructions:	UM1C48582000P3
Converter System to -48 VDC Power System Interface Kit Installation Instructions	IM10064868
Schematic Diagram:	SD584641000
Wiring Diagram:	T584641000

Vertiv.com | Vertiv Headquarters, 505 N Cleveland Ave, Westerville, OH 43082, United States

© 2024 Vertiv Group Corp. All rights reserved. Vertiv™ and the Vertiv logo are trademarks or registered trademarks of Vertiv Group Corp. All other names and logos referred to are trade names, trademarks or registered trademarks of their respective owners. While every precaution has been taken to ensure accuracy and completeness here, Vertiv Group Corp. assumes no responsibility, and disclaims all liability, for damages resulting from use of this information or for any errors or omissions. Specifications, rebates and other promotional offers are subject to change at Vertiv's sole discretion upon notice.

