



Liebert® iCOM™

Installer/User Guide

Intelligent Communication and Monitoring for Liebert® Mini-Mate 3, 4-5
Ton

The information contained in this document is subject to change without notice and may not be suitable for all applications. While every precaution has been taken to ensure the accuracy and completeness of this document, Vertiv assumes no responsibility and disclaims all liability for damages resulting from use of this information or for any errors or omissions.

Vertiv recommends installing a monitored fluid detection system that is wired to activate the automatic closure of field-installed coolant fluid supply and return shut off valves, where applicable, to reduce the amount of coolant fluid leakage and consequential equipment and building damage. Refer to local regulations and building codes relating to the application, installation, and operation of this product. The consulting engineer, installer, and/or end user is responsible for compliance with all applicable laws and regulations related to the application, installation, and operation of this product.

The products covered by this instruction manual are manufactured and/or sold by Vertiv. This document is the property of Vertiv and contains confidential and proprietary information owned by Vertiv. Any copying, use, or disclosure of it without the written permission of Vertiv is strictly prohibited.

Names of companies and products are trademarks or registered trademarks of the respective companies. Any questions regarding usage of trademark names should be directed to the original manufacturer.

Technical Support Site

If you encounter any installation or operational issues with your product, check the pertinent section of this manual to see if the issue can be resolved by following outlined procedures.

Visit <https://www.vertiv.com/en-us/support/> for additional assistance.

TABLE OF CONTENTS

1 Getting Started with Vertiv™ Liebert® iCOM™	1
1.1 Touchscreen Display and User Interface	1
1.2 Touchscreen Status Dial	3
1.2.1 Dial Background Color Status Indication	5
1.3 Control Header	6
1.3.1 Powering On the Vertiv™ Liebert® iCOM™ and Logging In/Unlocking Controls	6
1.3.2 Powering On the Thermal Management Unit	7
1.3.3 Powering Off the Thermal Management Unit	8
1.3.4 Logging Out	8
1.3.5 Calibrating the Touchscreen	8
1.3.6 Setting the Date and Time	9
1.3.7 Searching	9
1.4 Using Context Sensitive Help	9
1.5 About Vertiv™ Liebert® iCOM™ Version	10
1.6 Accessing the User, Service, and Advanced Menus	10
1.7 User Menu	10
1.7.1 User Menu Options	10
1.8 Service Menu	11
1.8.1 Service Menu Options	11
1.9 Advanced Menu	12
1.9.1 Advanced Menu Options	12
2 User Operation	15
2.1 Viewing and Editing Setpoints for the Cooling Unit	15
2.1.1 Editing Humidity Setpoints	15
2.1.2 Editing Temperature Setpoints	16
2.2 Viewing Unit Alarms	16
2.2.1 To View Alarms	17
2.2.2 Silencing an Audible Alarm	18
2.2.3 Acknowledging Alarms	18
2.3 Viewing the Event Log	19
2.4 Viewing Sensor Data	20
2.5 Managing Run Hours for a Component	20
2.5.1 Setting Run Hours to Zero	20
2.6 Viewing Teamwork, Standby, and Cascade Status	21
2.6.1 To View Teamwork Details	21
3 Service Operation	23
3.1 Editing Setpoints for the Cooling Unit	23
3.1.1 Setpoints Options	23

3.1.2	Configuring Temperature Setpoints	23
3.1.3	Temperature Control—Temperature Setpoints and Cooling Operation	26
3.1.4	Compressor Control by Cooling Requirement	28
3.1.5	Setting Temperature Compensation	28
3.1.6	Configuring High and Low Limit Setpoints	29
3.1.7	Configuring Humidity Setpoints	30
3.1.8	Humidity Control	31
3.1.9	Configuring Fan Setpoints	33
3.1.10	Manual Fan Speed Control	35
3.1.11	Automatic Fan Speed Control	35
3.1.12	Scheduling Sleep Times for Thermal Management Units	36
3.2	Setting General Thermal Management Unit Options	37
3.2.1	Setting Miscellaneous Options	37
3.2.2	Automatic Restart after Power Failure	39
3.2.3	Setting Fan Options	39
3.2.4	Setting Compressor Options	41
3.2.5	Setting Reheat Options	42
3.2.6	Reheat Control	43
3.2.7	Setting Humidifier Options	46
3.2.8	Setting Dehumidification Options	46
3.2.9	Setting Q15 Options	47
4	Managing Events: Alarms, Warnings and Messages	49
4.1	Event Properties	49
4.1.1	To Open the Panel	49
4.2	Enabling Events and Editing Event Settings	50
4.3	Selecting Event Type and Setting Alarm/Warning Notification	51
4.3.1	To Select Event Type and Notification	51
4.4	Enabling the Audible Alarm Notification	55
4.5	Remote Alarm Device and Customer Input Events	55
4.5.1	Setting Up Customer Input Events	55
5	Unit to Unit (U2U) Networking	59
5.1	Preparing for U2U Group Set Up	59
5.2	Configuring U2U Network Settings	60
5.2.1	To Configure U2U Networking	60
5.2.2	Troubleshooting Network Settings Issues	62
5.2.3	Modifying U2U Network Settings	62
6	Teamwork, Standby, and Rotation for Cooling Units	63
6.1	Continuous Control with Virtual Master	63
6.2	Teamwork Modes	63
6.2.1	To Set Up Team Work	63

6.2.2	No Teamwork—Multiple Zones in One Room	65
6.2.3	Teamwork Mode 1—Parallel Operation	65
6.2.4	Teamwork Mode 2—Independent Operation	66
6.3	Assigning Cooling Units to Standby (Lead/Lag)	66
6.3.1	To Set Up Lead/Lag Operation	66
6.4	Setting a Rotation Schedule	67
6.4.1	Unit Rotation Options	67
6.4.2	Manually Rotating the Operating and Standby Units	68
7	External Monitoring and BMS	69
7.1	BMS and Liebert® IntelliSlot™ Settings	69
7.1.1	Configuring BMS Communication with IntelliSlot Card	69
7.1.2	Setting BMS Control Settings	70
7.1.3	Setting BMS Backup Setpoints	71
8	Configuring Auxiliary Devices	73
8.1	Configuring Analog Input Devices	73
8.2	Wired Remote Sensors	74
8.2.1	Wired Remote Sensor Setup Options	74
8.2.2	Wired Remote Sensor—Sensor Property Options	75
9	Administering Firmware, Settings and Security	77
9.1	Vertiv™ Liebert® iCOM™ Firmware Upgrades	77
9.1.1	Compatibility with Earlier Versions of Liebert® iCOM™	77
9.1.2	Updating Liebert® iCOM™ Display Firmware	77
9.1.3	Updating Liebert® iCOM™ Control Board Firmware	77
9.2	Backing Up, Importing, Exporting, and Restoring Display Settings	79
9.2.1	To Back Up or Restore	79
9.2.2	Resetting Display Settings to Defaults	79
9.3	Backing Up and Restoring Control Board Settings	80
9.3.1	Control Board Back Up and Restore Options	80
9.4	Managing Access Permission and Passwords	81
9.5	Configuring with the Start Up Wizard	82
9.5.1	To Update System Information Using the Wizard	82
10	Performing Diagnostics	83
10.1	Cooling Unit Status LED	83
10.2	Enabling Manual Mode for Diagnostics	83
10.2.1	Disabling Diagnostics Manual Mode	84
10.3	Diagnosing Evaporator Fan Issues	84
10.3.1	Diagnostics—Evaporator Fan Options	84
10.4	Diagnosing Compressor Circuit Issues	85
10.4.1	Diagnostics—Compressor Circuit Options	85
10.4.2	Resetting High Pressure Alarm Code	86

10.4.3	Resetting Low Pressure Alarm Code	87
10.4.4	Resetting High Temperature Alarm Counter	87
10.5	Diagnosing Reheat Issues	87
10.5.1	Diagnostics—Reheat Options	87
10.6	Diagnosing Humidifier Issues	88
10.6.1	Diagnostics—Humidifier Options	88
10.7	Diagnosing Digital Output Issues	89
10.7.1	Diagnostics—Digital Output Options	89
10.8	Diagnosing Analog Output Issues	89
10.8.1	Diagnostics—Analog Output Options	89
10.9	Diagnosing Customer Input Issues	90
10.9.1	Diagnostics—Customer Input Options	90
11	Customizing Your Vertiv™ Liebert® iCOM™ Display	91
11.1	Setting General Display Properties	91
11.1.1	Unit Display Options	91
11.2	Customizing Main Display Views	92
11.2.1	Moving Content	92
11.2.2	Resizing Content	92
11.2.3	Adding and Adjusting Content	93
11.2.4	Removing Content	94
11.3	Customizing Parameter and Field Labels	94
11.3.1	Exporting, Importing, and Customizing Labels Using a Text Editor	96
12	Vertiv™ Liebert® iCOM™ Hardware Installation	99
12.1	Return Air Temperature/Humidity Sensor	99
12.1.1	P67: Return Air Temperature—Humidity Board	99
12.1.2	Jumper P3 CANbus Termination	102
12.2	Installing a Fluid Temperature Sensor	102
12.3	Installing Analog Input Devices	103
12.4	Installing the Unit to Unit (U2U) Network	104
12.4.1	Required Network Equipment	104
12.4.2	Planning Wiring Runs	104
12.4.3	U2U Wiring Connections	105
Appendices	107
Appendix A:	Technical Support and Contacts	107
Appendix B:	Setpoints and Alarm Settings by Line ID	109
Appendix C:	Submittal Drawings	145

1 Getting Started with Vertiv™ Liebert® iCOM™

The Liebert® iCOM™ offers the highest capability for unit control, communication, and monitoring of Liebert® Thermal Management units. It is available factory-installed on new units and assemblies or may be retrofitted in existing units.

1.1 Touchscreen Display and User Interface

The Liebert® iCOM™ touchscreen and user interface speeds set up and installation and simplifies control of Liebert® thermal management units, literally putting cooling system monitoring and management at your fingertips.

- The resistive touchscreen is used with a firm touch, or consider using a stylus when interacting with the touchscreen.
- User and service menus are password protected to prevent unauthorized changes to cooling unit operation.
- The touchscreen is backlit and auto dims after a period of non-use, then turns off. Touch the screen to illuminate the main screen.
- Liebert® iCOM™ ships with default settings for efficient and effective operation of most cooling units and is easily configured to meet any need.
- Liebert® iCOM™ menus and displays are based on the options installed on the cooling units that it monitors and manages.

Figure 1.1 Vertiv™ Liebert® iCOM™ Main Display

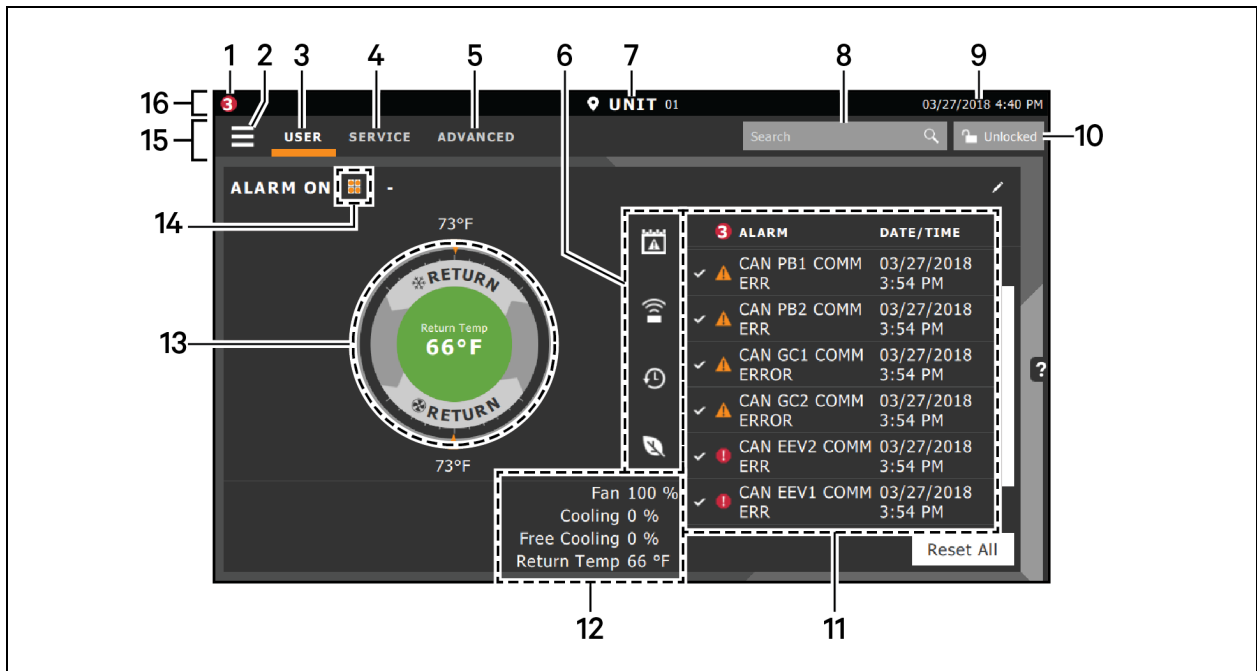

Table 1.1 Main Display Controls and Options

Item	Description
1	Alarms present. Displays the number of active alarms.
2	Menu icon. When unlocked, displays a menu for user or service options depending on which icon is selected.
3	User icon. When selected, the user options are available on the main display and menu. NOTE: You must unlock the display with the User PIN to access the menu and options. See .Powering On the Vertiv™ Liebert® iCOM™ and Logging In/Unlocking Controls on page 6.
4	Service icon. When selected, the service options are available on the main display and menu. NOTE: You must unlock the display with the Service PIN to access the menu and options. See Powering On the Vertiv™ Liebert® iCOM™ and Logging In/Unlocking Controls on page 6.
5	Advanced icon. When selected, the advanced options are available on the main display and menu. NOTE: You must unlock the display with the Service PIN to access the menu and read-only options. See Powering On the Vertiv™ Liebert® iCOM™ and Logging In/Unlocking Controls on page 6.
6	Cooling-unit parameters. Status display of selected system parameter settings. See Adding and Adjusting Content on page 93.
7	Unit Identification. You may customize the unit name up to 6 characters/numbers.
8	Search icon. Open the keyboard to search for controls and setting locations. See Searching on page 9.
9	Date/Time.
10	Lock/Unlock icon. Indicates whether or not the user and service options are accessible. <ul style="list-style-type: none"> Locked icon = display is read-only Unlocked icon = User or service is logged-in and options are accessible. See Powering On the Vertiv™ Liebert® iCOM™ and Logging In/Unlocking Controls on page 6.

Table 1.1 Main Display Controls and Options (continued)

Item	Description
11	Secondary content panel. When accessing settings/configuration via the menus, the settings display in the right, secondary panel.
12	Summary of current unit function. You can customize to show fan speed, cooling, percentages from any installed device, and any physical (sensor) values.
13	Status Dial. Circular display of setpoints and environmental conditions of the unit. See Touchscreen Status Dial below.
14	Teamwork-mode icon. In a panel with "Status" content, the Teamwork Mode icon indicates the mode selected. For details and descriptions of the teamwork controls, see Teamwork Modes on page 63
15	Control header. Controls to access the user and service menus. See .
16	Status Header. Displays the alarm status, unit identification, and the current date and time.

1.2 Touchscreen Status Dial

The dial in the primary control panel displays read-only control sensors, setpoints, and environmental conditions for unit status at a glance. See [Figure 1.2](#) on the next page.

The center of the dial displays sensor readings and changes color according to alarm thresholds as the readings rise and fall, see [Dial Background Color Status Indication](#) on page 5.

Touching the center of the dial cycles through a set of sensor settings, and you can select the readings displayed, see [Adding and Adjusting Content](#) on page 93.

Figure 1.2 Dial Sections

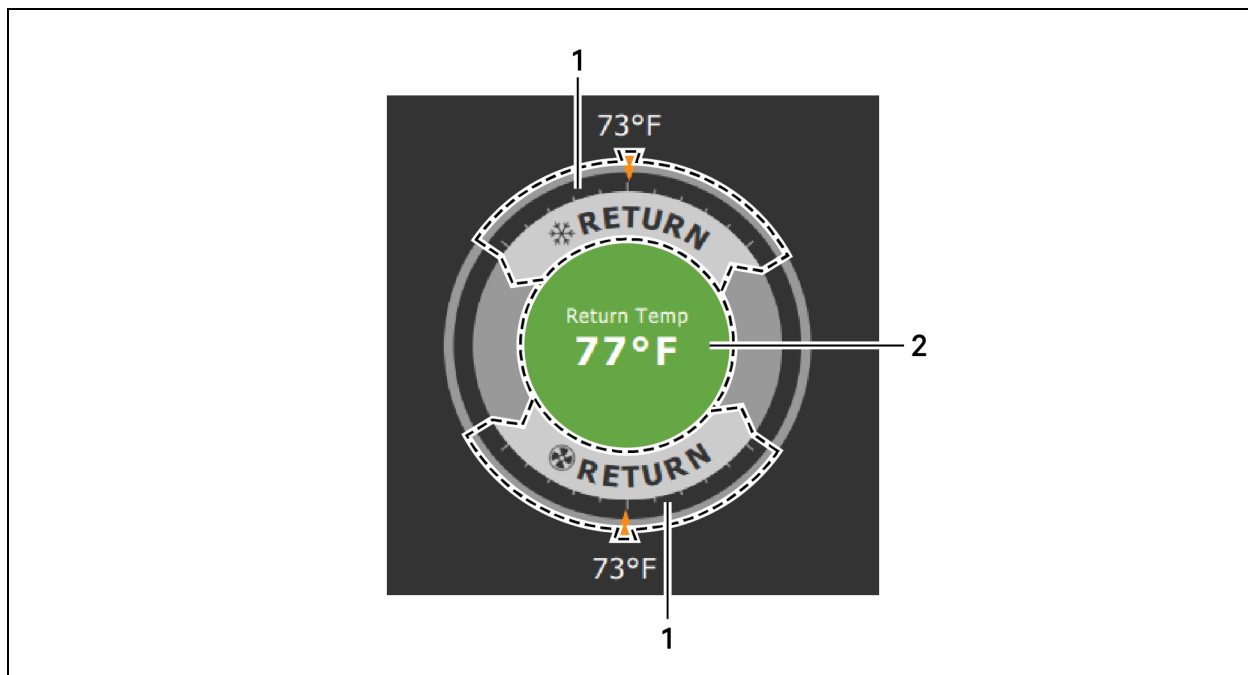

Table 1.2 Dial Sections

Item	Description
1	Control sensor and its setpoint. The sensors and setpoints displayed depend on the configuration of your unit. You may see only temperature-control, or if the unit includes humidity control, that displays on the dial as well. If the sensor selected for fan control is the same as that selected for temperature control, the dial displays the fan-control sensor and setpoint, as shown in Figure 1.2 above.
2	Single or multiple sensor readings. Cycle through readings by touching the displayed reading.

1.2.1 Dial Background Color Status Indication

The background color of the dial indicates whether or not the unit is powered on, and it also responds to threshold settings of the control sensor reading. See **Figure 1.3** below **Table 1.3** below. These illustrate the background color displayed if the selected sensor reading has threshold limits set.

Figure 1.3 Dial Background Colors

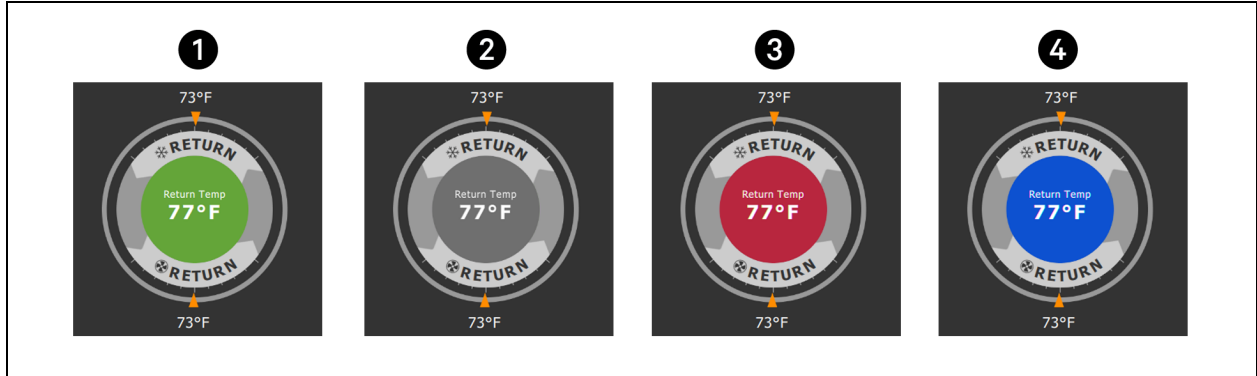

Item	Description
1	Sensor reading is within threshold limits.
2	Unit is powered off.
3	Sensor reading is above threshold limit or the unit is in an alarm condition.
4	Sensor reading is below threshold limit.

Table 1.3 Background Color Displayed by Selected Value and Threshold Limit

Sensor/Value selected	Threshold limit	Background color
Return Temp	None	Green
	High return temperature	Red
Return Humidity	Low return humidity	Blue
	High return humidity	Red
Dew Point	Low dew point	Blue
	High dew point	Red
Average Rack Temp	Low remote temperature	Blue
	High remote temperature	Red
Max Rack Temp	Low remote temperature	Blue
	High remote temperature	Red
Min Rack Temp	Low remote temperature	Blue
	High remote temperature	Red

Table 1.3 Background Color Displayed by Selected Value and Threshold Limit (continued)

Sensor/Value selected	Threshold limit	Background color
Static Pressure	Low static pressure	Blue
	High static pressure	Red
Outdoor Temp	None	Green
Outdoor Humidity	None	Green

1.3 Control Header

The control header contains the controls to access the user and service settings. The display is locked when started initially and when restarted after a period of inactivity.

1.3.1 Powering On the Vertiv™ Liebert® iCOM™ and Logging In/Unlocking Controls

Liebert® iCOM™ is powered on when power is switched on at the cooling unit's disconnect switch and you activate the display by touching it.



Liebert® iCOM™ is locked when started and also locks after a period of inactivity to prevent unauthorized changes. A four digit password is required to access the user and service menus and options, and the advance menu displays as read-only when logged-in at the service level.

NOTE: The factory-default inactivity period is one minute. To change the inactivity period, see [Setting General Display Properties](#) on page 91.

NOTE: The factory-default password for user and service login are provided. We recommend you change passwords as necessary to prevent unauthorized changes. See [Managing Access Permission and Passwords](#) on page 81.

- Default user password: 1490
- Default service password: 5010

To Unlock the Controls

1. On the header, touch . The keypad opens.
2. Touch the numbers/characters for your password, then touch . Depending on the password entered and your level of access, the User and/or Service options, and view-only access to the Advanced menu are accessible. See [Accessing the User, Service, and Advanced Menus](#) on page 10.

1.3.2 Powering On the Thermal Management Unit

NOTE: Depending on the operating state, there are start/stop priority switches that may prevent the cooling unit from operating even though power to the unit is switched on and you have turned it on via Liebert® iCOM™.

The cooling unit operates only when all switches are closed. For example, even though you have turned-on the unit through Liebert® iCOM™, if the BMS remote monitoring system is sending a command to turn off the unit, the cooling unit remains off.

NOTE: You must be logged in to access the menu options. See [Powering On the Vertiv™ Liebert® iCOM™ and Logging In/Unlocking Controls](#) on the previous page.

To Power On the Unit



1. Touch , then  > *Turn Unit On*. The TURN UNIT ON dialog opens.
2. Touch *Turn Unit On*. The cooling unit starts and the operating status is displayed as shown in [Figure 1.4](#) below.

Figure 1.4 Unit Status on Liebert® iCOM™ Display



Item	Description
1	Current status of the unit. See Cooling Unit Statuses Displayed below.
2	Teamwork icon. See Viewing Teamwork, Standby, and Cascade Status on page 21.

Table 1.4 Cooling Unit Statuses Displayed

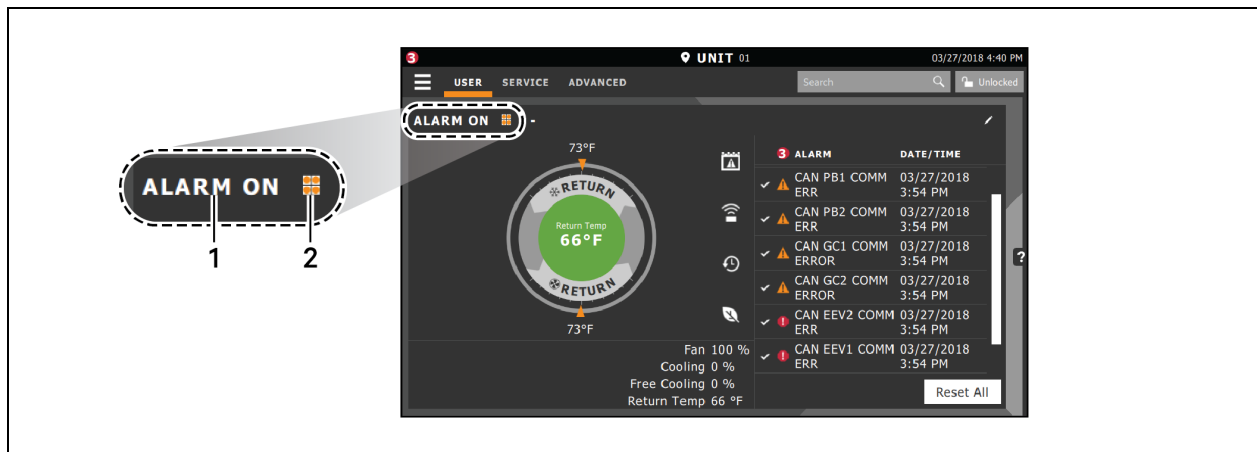

Unit Status Text	Description
ALARM OFF	An alarm forced the unit to turn off. See Viewing Unit Alarms on page 16.
MANUAL	Controlled by a service technician. See Enabling Manual Mode for Diagnostics on page 83.
DISPLAY OFF	Unit is turned Off at the Liebert® iCOM™ display. See Powering On the Thermal Management Unit above.
ALARM	In standby because of an active alarm on the unit. See Viewing Unit Alarms on page 16.

Table 1.4 Cooling Unit Statuses Displayed (continued)

Unit Status Text	Description
STANDBY	
STANDBY	In standby because of service menu setting. See Assigning Cooling Units to Standby (Lead/Lag) on page 66.
UNIT ON	Operating normally without alarms or warnings.
WARNING ON	Active warning, but still operating. See Viewing Unit Alarms on page 16.
ALARM ON	Active alarm, but still operating. See Viewing Unit Alarms on page 16.
REMOTE OFF	Turned-off by remote shutdown terminal. Occurs when a normally-closed set of 24-V contacts opens. The Remote On/Off and Display On/Off switches are in series, and the cooling unit will only turn on if both switches are on/closed. If one is off/open, the unit turns off.
MONITORING OFF	Turned-off by remote monitoring system. Check the remote monitoring device or call Vertiv™ technical support for assistance.
BACK-DRAFT	Unit is not operational, but EC fan is operating as a back draft damper.
RESTART DELAY	Not yet operational after a power cycle because the restart-delay timer is active.

1.3.3 Powering Off the Thermal Management Unit

NOTE: You must be logged in to access the menu options. See [Powering On the Vertiv™ Liebert® iCOM™ and Logging In/Unlocking Controls](#) on page 6.

1. Touch , then  > *Turn Unit Off*. The TURN UNIT OFF panel opens.
2. Touch *Turn Unit Off*. The unit begins a power off countdown then powers-off.

1.3.4 Logging Out

Log out occurs automatically when the display back light turns off for inactivity.

NOTE: The factory default inactivity period is one minute. To change the inactivity period, see [Setting General Display Properties](#) on page 91.

- To log out manually, touch the lock icon. The icon indicates LOCKED.

1.3.5 Calibrating the Touchscreen



Use a firm touch or a stylus for the best response. To improve interaction with quicker and more accurate touch response, calibrate the touchscreen.

1. On the User menu, touch *Display Options* > *Display Properties*.
2. On the UNIT DISPLAY panel, touch *Calibrate Screen* and follow the prompts to calibrate.
 - If you cannot access the calibration because of screen response, continue with step 3.
3. At the cooling unit disconnect switch, power off the unit and then back on.
4. Touch your finger to the screen and hold it there while the display boots.

5. When the LED begins flashing, remove your finger.
Cross hairs appear in each corner and in the center of the display.
6. Touch the center of each cross hair ONCE ONLY. (Touching more than once interrupts the calibration and you must start over at step 3.) Cross hairs disappear and the display reboots when calibration is complete.

1.3.6 Setting the Date and Time

The correct date and time is critical for warnings, alarms, and scheduling.

1. Touch , then  > *Display Options* > *Display Properties* > *Date & Time*.
2. Touch the date field, use the arrows to select the date, and touch *OK*.
– or –
Touch the time field, use the arrows to set the time, and touch *OK*.
3. Select the date and time format if necessary.
4. Touch *Save*.

1.3.7 Searching

When logged in, you can use the display search to find the location of settings options based on a term, service code, or parameter. You can also search by the line ID used in the Vertiv™ Liebert® iCOM™ before the touchscreen model. For a listing of the line IDs, see [Setpoints and Alarm Settings by Line ID](#) on page 109.

NOTE: You must be logged in to access the display search. See [Powering On the Vertiv™ Liebert® iCOM™ and Logging In/Unlocking Controls](#) on page 6.

1. In the control header, touch the search field. The keyboard opens.
2. Type the term and touch . A list of locations that contain the searched term opens.
3. To go to a listed location, touch an item, then touch *Go*. The panel for the selected location opens.

– or –

To view the service codes and parameter entries related to the searched term, touch *View Parameter Directory Entries* (the number of related entries is included in the option).

The Parameter Directory opens. You may further refine the search in the directory.

1.4 Using Context Sensitive Help

Touching the Help icon  on the right-hand side of the display opens the Help drawer with information about the panel or dialog currently on the display.

You can use search and the topic index to find further information.

To close the Help drawer, touch the close arrow .

1.5 About Vertiv™ Liebert® iCOM™ Version



The version, build, and other firmware information for the Liebert® iCOM™ display board may be helpful when servicing or troubleshooting. To locate the firmware version of the Liebert® iCOM™ control board, see [Updating Liebert® iCOM™ Control Board Firmware](#) on page 77.

- Touch , then  > *About*. The ABOUT panel opens.

1.6 Accessing the User, Service, and Advanced Menus

Liebert® iCOM™ operating functions that monitor and control a cooling unit are accessed via the User and Service menus.

NOTE: You must be logged in to access the menu options. See [Powering On the Vertiv™ Liebert® iCOM™ and Logging In/Unlocking Controls](#) on page 6.

1. To access a menu, touch the icon for the menu you want, , , or , in the control header, see [Control Header](#) on page 6.

The orange bar appears below the menu name when selected indicating that this is the menu content that will be displayed.

2. Touch the menu icon, . The menu opens.

1.7 User Menu

The user menu lets you view system and unit statuses and edit some setpoints.

1.7.1 User Menu Options

Setpoints

Opens the SETPOINTS panel. See [Viewing and Editing Setpoints for the Cooling Unit](#) on page 15.

Active Alarms

Opens the ALARMS panel. See [Viewing Unit Alarms](#) on page 16.

Event Log

Opens the EVENT LOG panel. See [Viewing the Event Log](#) on page 19.

Sensor Data

Opens the SENSOR DATA panel. See [Viewing Sensor Data](#) on page 20.

Display Options

Opens the Display Options menu:

- Customize Layout—see [Customizing Main Display Views](#) on page 92.
- Custom Labels—see [Customizing Parameter and Field Labels](#) on page 94.
- Date & Time—see [Setting the Date and Time](#) on page 9.

Total Run Hours

Opens the RUN HOURS panel. See [Managing Run Hours for a Component](#) on page 20.

About

Opens the ABOUT panel. See [About Vertiv™ Liebert® iCOM™ Version](#) on the previous page.

Turn Unit On/Off

Depending on unit's status, open the TURN UNIT ON or TURN UNIT OFF dialog. See [Powering On the Thermal Management Unit](#) on page 7, or [Powering Off the Thermal Management Unit](#) on page 8.

1.8 Service Menu

The service menu lets you view and edit setpoints and perform many other functions.

1.8.1 Service Menu Options

Setpoints

Opens the SETPOINTS panel. See [Editing Setpoints for the Cooling Unit](#) on page 23

Diagnostic/Service

Opens the Diagnostic/Service menu:

- Diagnostics—see [Performing Diagnostics](#) on page 83.
- Technical Support—contact information for the cooling unit and Vertiv™ Liebert® iCOM™ display.

Alarm/Event Setup

Opens the ALARMS & EVENTS panel. See [Managing Events: Alarms, Warnings and Messages](#) on page 49

BMS & Teamwork

Opens the BMS & Teamwork menu:

- U2U Setup—See [Configuring U2U Network Settings](#) on page 60.
- Teamwork/Standby—See [Teamwork, Standby, and Rotation for Cooling Units](#) on page 63.
- BMS Setup—See [BMS and Liebert® IntelliSlot™ Settings](#) on page 69.

Options Setup

Opens the OPTIONS SETUP panel. See [Setting General Thermal Management Unit Options](#) on page 37.

Auxiliary Device Setup

Opens the Auxiliary Device Setup menu:

- Sensors—See [Wired Remote Sensors](#) on page 74.
- Analog Input—See [Configuring Analog Input Devices](#) on page 73.
- Modbus Devices
- CapCom

Backup & Security

Opens the Backup & Security menu:

- Display Backup and Restore. See [Backing Up, Importing, Exporting, and Restoring Display Settings](#) on page 79.
- Control Backup and Restore. See [Backing Up and Restoring Control Board Settings](#) on page 80.
- Display Upgrade. See [Updating Liebert® iCOM™ Display Firmware](#) on page 77 .
- Control Upgrade. See [Updating Liebert® iCOM™ Control Board Firmware](#) on page 77.
- Manage Permissions. See .

Turn Unit On/Off

Depending on unit's status, open the TURN UNIT ON or TURN UNIT OFF dialog. See [Powering On the Thermal Management Unit](#) on page 7 and [Powering Off the Thermal Management Unit](#) on page 8.

1.9 Advanced Menu

The advanced menu provides a read-only view of the advanced set up and factory level settings.

1.9.1 Advanced Menu Options

Factory Settings

Unit code and configuration settings.

Diagnostics

Details about control and cooling operation.

Expert Settings

Parameters and settings for use by trained professionals only.

Compressor Info

Details about compressor state and operating mode.

Tandem Info

Details about tandem compressor states and operating modes.

MBV Settings

Motorized ball valve settings (water cooled heat rejection).

Runtime Monitoring

Details about component run times.

Modbus Devices

Information about connected Modbus devices such as power and flow meters.

Control Override

Allows simulating events and override of analog outputs beyond normal limits.

EEV Settings

Electronic expansion valve settings.

EconoPhase

Details about EconoPhase pumping unit.

MC Condenser

Details about MC condenser (air cooled heat rejection).

Parameter Directory

A searchable list of all parameters in the user interface. See [Setpoints and Alarm Settings by Line ID](#) on page 109.

This page intentionally left blank



2 User Operation

2.1 Viewing and Editing Setpoints for the Cooling Unit

NOTE: User level access allows viewing and editing only a limited number of setpoints. To view or adjust all setpoints, you must have service level access. See [Editing Setpoints for the Cooling Unit](#) on page 23.

NOTE:

2.1.1 Editing Humidity Setpoints

1. Touch , then  >Setpoints. > Humidity Control. The HUMIDITY CONTROL secondary panel opens.
2. Refer to the [User Humidity Setpoint Options](#) below and [Humidity Control](#) on page 31 to adjust the setpoint options, then touch Save. The setpoint is updated.
 - Touch *Cancel* to discard the changes.

NOTE: Depending on the type of thermal management unit, included components, and control settings of your system, all of the options listed may not be available on your Vertiv™ Liebert® iCOM™ display.

User Humidity Setpoint Options

Dew Point Setpoint

Desired dew point (based on actual return air temperature and humidity) by adding moisture to or removing moisture from the air.

Humidity Control Sensor

Selects sensor used when calculating relative humidity.

Humidity Control Type



Control when staging humidification operations. Valid values are:

- Relative: Percent of humidification/dehumidification is determined by the difference between the humidity sensor reading and the humidity setpoint.
- Compensated: Percent of humidification/dehumidification is determined by considering the actual deviation from the temperature setpoint and adjusts the humidity setpoint accordingly. The recalculated humidity setpoint displays on the screen.
- Predictive: Percent of humidification/dehumidification is determined by considering the actual deviation from the temperature setpoint and adjusts the humidity sensor reading accordingly. The adjusted humidity sensor reading displays on the screen.
- Dew point: Percent of humidification/dehumidification is determined by the difference between the dew point calculated from the humidity-sensor reading and the dew point setpoint.

Humidity Setpoint

Desired humidity level by adding moisture to or removing moisture from the air.

2.1.2 Editing Temperature Setpoints

1. Touch , then  > *Setpoints* > *Temperature Control*. The TEMPERATURE CONTROL secondary panel opens.
2. Refer to [User Temperature Setpoint Options](#) below, [Temperature Control—Temperature Setpoints and Cooling Operation](#) on page 26, and [Compressor Control by Cooling Requirement](#) on page 28 to adjust the setpoint options, then touch *Save*.
The setpoint is updated.
 - Touch *Cancel* to discard the changes.

NOTE: Depending on the type of thermal management unit, included components, and control settings of your system, all of the options listed may not be available on your Vertiv™ Liebert® iCOM™ display.

User Temperature Setpoint Options

BMS Backup Temp Setpoint

Selects a temperature setpoint that activates in the event of a BMS timeout. The BMS timer must be configured for this setpoint to activate. See [Setting BMS Backup Setpoints](#) on page 71.

Temperature Control Sensor

Selects sensor that controls cooling. Values are:

- Remote Sensor: Temperature control is based on the temperature reading(s) from wired remote sensor(s). See [Wired Remote Sensors](#) on page 74.
- Return Sensor: Temperature control is based on maintaining the temperature of the air returning to the cooling unit.

Temperature Setpoint Act

Read-only display of adjusted temperature setpoint when one of the following is active:

- Temperature compensation
- BMS back-up temperature setpoint
- Customer-input setpoint (remote-alarm device)

Temperature Setpoint

Temperature that the unit maintains via cooling/reheat.

2.2 Viewing Unit Alarms

The ALARMS panel lists active alarm and warning events. **Table 21** on the facing page describes the type and state of the alarm shown by indicator dots.

Table 2.1 Alarm Status/Type Indicators

Indicator	Description
Yellow dot	Warning event.
Red dot	Alarm event.
Circle	Event condition has cleared, but still must be acknowledged. See Acknowledging Alarms on the next page.

2.2.1 To View Alarms

1. Touch , then  > *Alarms*. The ALARMS panel opens.
2. Touch an alarm to display the ALARM DETAILS panel.

Alarm Fields

Alarm

Name of the event.

Date

Date event was logged.

Time

Time event was logged

Alarm Detail Fields

Alarm

Name of the event.

Alarm Type

Number representing the event type.

- 1: Warning
- 2: Alarm

Date/Time

Date and time the event was logged.

Duration

Time elapsed since event was logged.

Threshold

Sensor-reading at which an event is triggered.

Unit

Cooling unit to which the alarm applies.

Value

The current value to which the threshold is compared.

2.2.2 Silencing an Audible Alarm

Touch the screen to silence an audible alarm. If the alarm is non-latching, the alarm silences when the condition clears.

NOTE: The audible alarm must be enabled in display options to sound. See [Enabling the Audible Alarm Notification](#) on page 55.

2.2.3 Acknowledging Alarms

Depending on the notification settings, alarms and warnings must be acknowledged or reset. An event is active as long as it is unacknowledged, with the exception of the network-failure events described in [Table 2.2](#) on the facing page. Once acknowledged, an event remains active until the situation that triggered the event is resolved, see [Alarm Status/Type Indicators](#) on the previous page, for event status indicators. When an event acknowledged and cleared, it is removed from the Alarms panel and the LED stops flashing red.

NOTE: Acknowledging alarm events does not clear them. To clear an issue, it must be corrected, reset automatically by the controller or reset manually.

To Acknowledge Alarms

1. On the ALARMS panel, touch *Acknowledge All*.

A check mark overlays the status indicator of the active alarms and warnings, and these automatically clear when the condition is no longer present.

- If a critical event must be manually reset, the acknowledged items are listed with a Reset All button on the ALARMS panel.

2. Touch *Reset All* to manually reset the condition.

Table 2.2 Events That Clear without Acknowledgment

Network Failure	Description
UNIT XX DISCONNECTED	The Liebert® iCOM™ I/O board assigned as U2U address number XX (two up to thirty-two) has lost communication with the group. Make sure all units are powered-on at the disconnect. Check cable connections and network settings where applicable.
NO CONNECTION W/UNIT 1	The Liebert® iCOM™ I/O board assigned as U2U address number 1 has lost communication with the group. Make sure all units are power on at the disconnect. Check cable connections and network settings where applicable.
BMS DISCONNECT	The BMS/BAS has not completed a handshake within the time defined by the BMS/BAS. Verify monitoring connections and communication to the BMS/BAS panel.
UNIT CODE MISSING	The factory unit code must be confirmed, saved and executed.
UNIT CODE MISMATCH	The factory unit code must be confirmed, saved and executed.

2.3 Viewing the Event Log

The event log is a list by date/time of the last 400 events generated by Vertiv™ Liebert® iCOM™ for the thermal-management unit.

- On the User menu, touch *Event Log*.

The EVENT LOG for the cooling unit opens. **Table 2.3** below describes the color-coded status for each event.



NOTE: Depending on the type of thermal management unit, included components, and control settings of your system, the options on your Liebert® iCOM™ display may differ.

Table 2.3 Event Status and Type Indicators

Indicator	Description
Green dot	Message.
Yellow dot	Unacknowledged warning event. See Acknowledging Alarms on the previous page.
Red dot	Unacknowledged alarm event. See Acknowledging Alarms on the previous page.
White dot with check mark overlay	Acknowledged event, the cause still exists.
White circle	Acknowledged event, the cause is cleared.

2.4 Viewing Sensor Data

The Sensor Data panel lists the standard and optional sensors monitored by Liebert® iCOM™ and the current reading of each sensor.



- Touch , then  > *Sensor Data*. The SENSOR DATA panel opens.

A secondary panel displays the DAILY SENSOR READING SUMMARY, which shows temperature, humidity and dew-point readings for the cooling unit.

NOTE: Depending on the type of thermal management unit, included components, and control settings of your system, the options on your Liebert® iCOM™ display may differ.

2.5 Managing Run Hours for a Component

You can view the run hours for components on a cooling unit, set the total run time limit, and reset total run hours to zero.

1. Touch , then  > *Total Run Hours*.
The RUN HOURS panel opens and the current hours for each component are listed in the Total Run Hours column.
To reset the total run hours to zero, see [Setting Run Hours to Zero](#) below.
2. Use the slider to set the total-run-time limit for each component, then touch *Save*.
The limits are set.

NOTE: Depending on the type of thermal management unit, included components, and control settings of your system, the options on your Vertiv™ Liebert® iCOM™ display may differ.

2.5.1 Setting Run Hours to Zero

1. On the RUN HOURS panel, touch to check each box in the *Total Run Hours* column next to the component(s) to reset. The Set to Zero button becomes available.
2. Touch *Set to Zero*. The total run hours for selected component(s) is set to zero.

2.6 Viewing Teamwork, Standby, and Cascade Status

In the main User panel, the Teamwork Mode icon indicates the mode selected, **Figure 2.1** below.

2.6.1 To View Teamwork Details

Touch the Teamwork mode icon.

The teamwork dialog opens displaying the teamwork mode, number of units in standby, and number of operating units.

NOTE: You must be logged in with the Service PIN to edit teamwork mode. See [Powering On the Vertiv™ Liebert® iCOM™ and Logging In/Unlocking Controls](#) on page 6.

Figure 2.1 Teamwork Icons

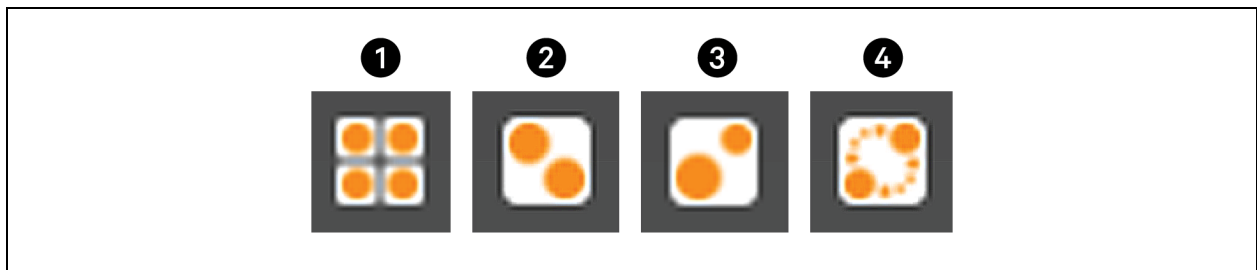

Item	Description
1	No teamwork.
2	Mode 1 - Parallel teamwork
3	Mode 2 - Independent teamwork
4	Mode 3 - Optimized aisle teamwork NOTE: Not applicable to Liebert® Mini-Mate units.

This page intentionally left blank

3 Service Operation

3.1 Editing Setpoints for the Cooling Unit

Setpoints are the means by which cooling unit operation is controlled.

NOTE: Depending on the type of thermal-management unit, included components, and control settings of your system, all of the options listed may not be available on your Vertiv™ Liebert® iCOM™ display.

3.1.1 Setpoints Options

Fan Control

See [Configuring Fan Setpoints](#) on page 33.

High/Low Limit Control

See [Configuring High and Low Limit Setpoints](#) on page 29.

Humidity Control

See [Configuring Humidity Setpoints](#) on page 30.



Temperature Control

See [Configuring Temperature Setpoints](#) below.

Temperature Compensation

See [Setting Temperature Compensation](#) on page 28.

3.1.2 Configuring Temperature Setpoints

1. Touch , then  > *Setpoints* > *Temperature Control*.
The TEMPERATURE CONTROL secondary panel opens.
2. Refer to [Temperature Control Options](#) on the next page, [Temperature Control—Temperature Setpoints and Cooling Operation](#) on page 26, and [Compressor Control by Cooling Requirement](#) on page 28 to adjust the setpoint options.

Touch Save. The setpoint is updated.

NOTE: Proportional band setting is dependent on the heat load and the components specific to your cooling unit. Additional tuning may be required after start up when using PI temperature control. See [Considerations when Using PI Temperature Control](#) on page 28.

NOTE: Depending on the type of thermal management unit, included components, and control settings of your system, all of the options listed may not be available on your Liebert® iCOM™ display.

Temperature Control Options

AutoSet Enabled

When enabled, the proportional band for temperature and humidity and both integration time factors are set automatically based on the type of cooling unit (single-compressor, dual-compressor or chilled-water).

NOTE: General settings cannot be adjusted or changed when AutoSet is enabled. If you make a change when AutoSet is enabled, the parameter defaults back to its original setting.

BMS Backup Temp Setpoint

Temperature that the cooling unit maintains during BMS back-up operation.

Dehumidification Reheat Proportional Band

Sets reheat operation independently from the Temperature Proportional band. Adjusts the activation point of dehumidification components based on deviation of the selected Dehumidification Reheat Temp Control sensor and the Dehumidification Reheat setpoint by placing half of the selected value on each side of the setpoint. A smaller number causes faster reaction to temperature changes.

Dehumidification Reheat Setpoint

Temperature that the unit maintains via dehumidification reheat.

Dehumidification Reheat Temp Control Sensor

Selects the sensor that controls dehumidification reheat. Values are:

- REM: Temperature control is based on the temperature reading(s) from wired remote/rack sensor(s). See [Wired Remote Sensors](#) on page 74.
- RET: Temperature control is based on maintaining the temperature of the room air.

Heater Deadband

Widens the setpoint to prevent small temperature changes from cycling re-heat components.

Temperature Control Sensor

Selects sensor that controls cooling. Values are:

- Remote Sensor: Temperature control is based on the temperature reading(s) from wired remote/rack sensor(s). See [Wired Remote Sensors](#) on page 74.
- Return Sensor: Temperature control is based on maintaining the temperature of the room air.

Temperature Control Type

Control when staging cooling and heating operations. Valid values are:

- Proportional: Percent of cooling/heating determined by the difference between the air temperature sensor reading and the temperature setpoint.
- PI: Percent of cooling/heating calculated using the temperature proportional band and temperature-integration time settings. See [Considerations when Using PI Temperature Control](#) on page 28.
- Adaptive PID: Auto-tuning PID control loop, can be set for Cooling. Only available on Liebert® CW (chilled water) systems.
- Intelligent: Percent of cooling/heating determined by programmed logic that simulates manual human control.

Temperature Deadband

Widens the setpoint to prevent small temperature changes from cycling compressors and valves maximizing component life. When temperature is within the deadband, no change of the control output (heating/cooling) occurs.

Temperature Integration Time

Adjusts amount of cooling/heating based on the length of time the temperature has deviated from the setpoint. The time selected is the amount of time it will take cooling capacity to reach 100%. For example, if three minutes is selected, cooling capacity will increase to 100% in three minutes.

NOTE: Three to five minutes of integration time is adequate for most applications. See [Considerations when Using PI Temperature Control](#) on page 28.

NOTE: Only used when Temperature Control Type is PI.

Temperature Proportional Band

Adjusts the activation point of cooling/heating components based on deviation from setpoint by placing half of the selected value on each side of the temperature-control setpoint. A smaller number causes faster reaction to temperature changes.

NOTE: Setting this too low causes short cycling of compressors.

Temperature Setpoint

Temperature that the unit maintains via cooling/reheat.

Temperature Setpoint Act

Read-only display of adjusted temperature setpoint when one of the following is active:

- Temperature compensation
- BMS backup temperature setpoint

3.1.3 Temperature Control—Temperature Setpoints and Cooling Operation

Temperature control refers to the cooling unit’s response to programmed setpoints and sensed room/load conditions. Temperature control is closely-tied to the primary cooling source. Liebert® Thermal mangement units employ several types of primary cooling sources.

Compressor Operation

Vertiv™ Liebert® iCOM™ controls the cooling units based on a calculated need for cooling (and heating, if included on your system). The requirement is expressed as a percentage (%) and is calculated using the selected temperature-control type.

Temperature Proportional Band

Use the proportional and dead-band parameters to control how your cooling unit(s) respond based on the calculated need for cooling (or heating). **Figure 3.1** below, illustrates temperature control using:

- 70° setpoint
- 10° proportional band
- No deadband

The proportional band is divided evenly on each side of the setpoint.

- 0% cooling capacity is required at 70°.
- As the air temperature increases, cooling also increases along the proportional band.
- If the air temperature reaches 75°, the system operates at 80% cooling capacity.
- If air temperature rises to the end of the proportional band or further, the system operates at 100% capacity to bring the temperature down to the setpoint.
- If your unit includes reheat, the heating capacity operates in the same way as the air temperature falls below the setpoint. See [Reheat Control](#) on page 43.

Figure 3.1 Temperature Control without a Deadband

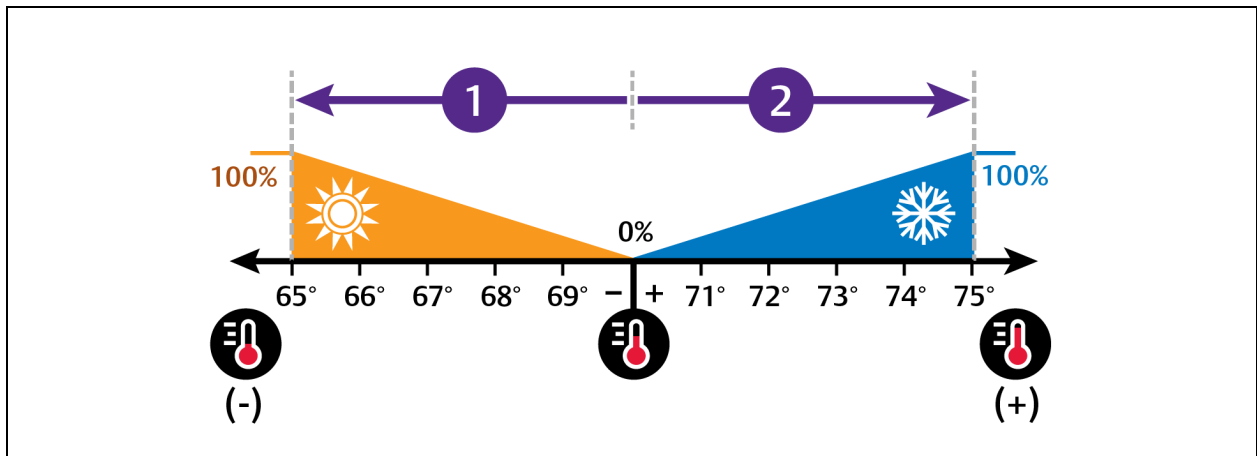

Item	Description
1	½ of proportional band.
2	½ of proportional band.

Temperature Deadband

A deadband widens the setpoint to prevent small temperature changes from activating compressors and valves and cause excessive component cycling. **Figure 3.2** below, illustrates temperature control using:

- 70° setpoint
- 10° proportional band
- 2° deadband

Like the proportional band, the deadband is also divided evenly on each side of the setpoint.

- 0% cooling capacity is required from 69° to 71°.
- At 71°, the system operates according to the temperature proportional band.

Figure 3.2 Temperature Control with a Deadband

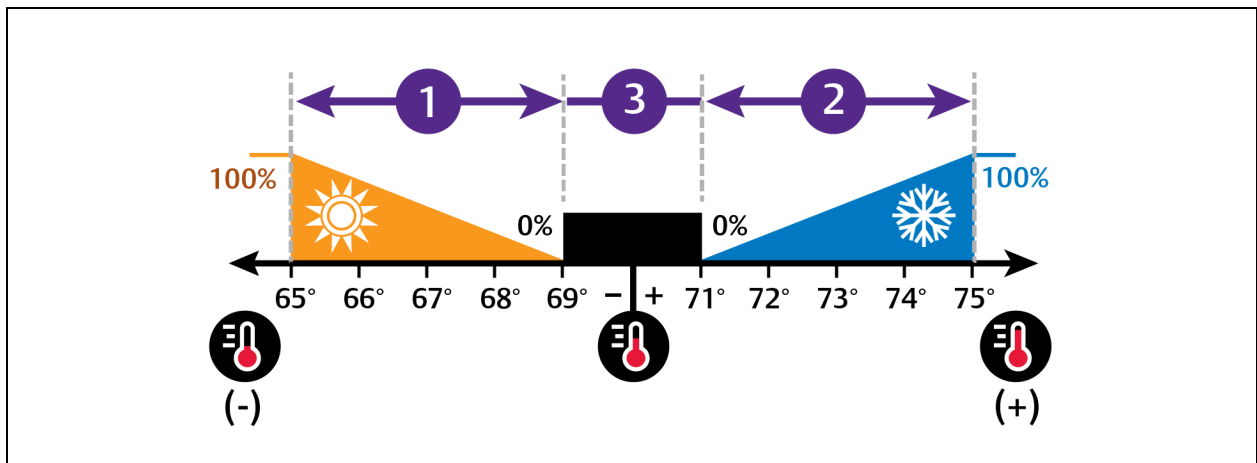

Item	Description
1	½ of proportional band.
2	½ of proportional band.
3	Deadband.

Considerations when Using PI Temperature Control

Several factors, such as room heat load, external heat gains, and component specific performance can affect the PI control loop. Adjusting the temperature proportional band and integration time can improve cooling unit performance and avoid problems detailed in **Table 3.1** below.

Table 3.1 PI Temperature Control Troubleshooting

Problem	Solution
Cooling is slow to activate	Decrease the proportional band slightly and monitor operation. Repeat until cooling reaction time is acceptable.
Compressor short cycle alarm	Increase the proportional band slightly by increasing the integration time between 3 and 5 minutes, and monitor compressor run time. Set the temperature deadband to 2. Run time must be more than 3 minutes to prevent a short-cycle of the compressor.
Excessive valve oscillation or hunting	Increase the proportional band and/or increase integration time.

3.1.4 Compressor Control by Cooling Requirement



Compressor control is directly linked to temperature control in that the cooling requirement determined by the temperature proportional band determines compressor operation. Depending on the type of cooling unit, the number and type of compressors varies. The following describes compressor operation along the proportional band for the varying compressor options.

Two Step Scroll Compressors

Two step scroll compressors operate at two different capacities: 67% and 100%. A solenoid valve inside the compressor is used to modulate the capacity. The compressor operates at full load or 100% capacity when the solenoid valve is energized and it operates at partial load or approximately 67% capacity when the valve is de-energized. The loading and unloading of the two step scroll compressor is done without shutting off the motor between steps.

3.1.5 Setting Temperature Compensation

Temperature compensation provides protection from changes that affect capacity and heat load by monitoring temperature conditions and fan speed settings, then automatically adjusting the temperature setpoint. Changes that may cause temperature compensation are floor tile removal in non-cold aisle areas, unit failure in a neighboring zone, or unexpected heat load fluctuations at rack equipment.

1. Touch , then  > *Setpoints* > *Temperature Compensation*. The TEMPERATURE COMPENSATION secondary panel opens.
2. Select the Compensation Type, then touch Save. The setpoint is updated.
 - Return temperature compensation cannot be used when both fan and cooling control is set to Return.

NOTE: When temperature compensation is enabled and active, the Temperature Setpoint Act field on the Temperature Control setpoints panel displays the adjusted setpoint value.

NOTE: Depending on the type of thermal management unit, included components, and control settings of your system, all of the options listed may not be available on your Vertiv™ Liebert® iCOM™ display.

Temperature Compensation Options

Compensation Type

Selects the compensation routine:



- No: Temperature compensation routine disabled.
- Return: Increases the temperature setpoint when the return air temperature is too cold.

3.1.6 Configuring High and Low Limit Setpoints

Setting the dehumidification low limits avoids over cooling a room during dehumidification. When a low limit is reached, the cooling source used for dehumidification is disabled. Dehumidification resumes when air temperature rises above the low limit reset value.

NOTE: Dehumidification lock out can occur with improper low limit settings. To avoid lock out, increase heat load for efficient operation, decrease low limit settings slightly, and where applicable, decrease the reheat proportional band to allow reheat sooner.

To Set High and Low Limits

1. Touch  , then  > *Setpoints* > *High/Low Limit Control*. The HIGH/LOW LIMIT CONTROL secondary panel opens.
2. Adjust the setpoint options, then touch *Save*. The setpoint is updated.
 - Touch *Cancel* to discard the changes.

NOTE: Depending on the type of thermal management unit, included components, and control settings of your system, all of the options listed may not be available on your Vertiv™ Liebert® iCOM™ display.

High and Low Limit Control Options

Dehum Low Limit X

Temperature at which dehumidification is interrupted, where X is limit 1 or 2.

Dehumidification Low Limit Sensor

Selects the sensor that is used for the low limit determination.

Dehumidification Low Limit Setpoint

Temperature below which dehumidification is disabled.



High Return Limit

Enables/disables use of additional fan speed based on return air temperature.

Return Limit P-Band

Calculates fan speed based on proportional deviation from the return air temperature.

3.1.7 Configuring Humidity Setpoints

1. Touch , then  > *Setpoints > Humidity Control*. The HUMIDITY CONTROL secondary panel opens.
2. Refer to [Humidity Control Options](#) below and [Humidity Control](#) on the facing page to adjust the setpoint options, then touch *Save*. The setpoint is updated.
 - Touch *Cancel* to discard the changes.

NOTE: Depending on the type of thermal management unit, included components, and control settings of your system, all of the options listed may not be available on your Vertiv™ Liebert® iCOM™ display.

Humidity Control Options

Control Dewpoint

Dewpoint setpoint.

Dewpoint Deadband

Widens the setpoint to prevent small changes from cycling compressors and valves maximizing component life. When temperature is within the deadband, no change of the control output (humidification) occurs.

Dewpoint P-Band

Adjusts the activation point of humidifier/dehumidification components based on deviation from setpoint by placing half of the selected value on each side of the dew point setpoint. A smaller number causes faster reaction to humidity changes.

Dewpoint Setpoint

Humidity level (based on actual return air temperature and humidity) by adding moisture to or removing moisture from the air.

Humidity Control Sensor

Selects sensor used when calculating relative humidity.

Humidity Control Type

Controls humidification/dehumidification operation. Valid values:

- Proportional: percent of humidification/dehumidification determined by the difference between the humidity sensor reading and the humidity setpoint.
- Dew Point: percent of humidification/dehumidification determined using the measured return temperature and humidity to calculate the dew point and comparing it to the setpoints.

NOTE: When dew point is selected, the humidity setpoint and proportional band units are degrees dew point.

- Relative: Percent of humidification/dehumidification determined using the measured humidity content of the air to calculate the percent relative humidity (RH) and comparing it to the setpoints.

NOTE: Relative humidity control can cause unnecessary humidification/dehumidification from over cooling based on a higher than normal RH reading that causes extended dehumidification. This in turn causes a low RH reading that activates the humidifier.

- Compensated: Percent of humidification/dehumidification determined using the measured humidity content of the air and automatically adjusting the humidity setpoint.

NOTE: Compensated humidity control prevents unnecessary humidification/dehumidification noted with relative humidity control.

- Predictive: Percent of humidification/dehumidification determined using the measured humidity content of the air and automatically adjusting the humidity-sensor reading.

Humidity Deadband

Widens the setpoint to prevent small changes in humidity from cycling components and also maximizes component life. When humidity is within the deadband, no humidification/dehumidification occurs.

Humidity Integration Time

Adjusts unit capacity based on the length of time the humidity has deviated from the setpoint. Works in conjunction with the proportional band to maintain tight setpoint control.

Humidity Proportional Band

Adjusts the activation point of humidifier/dehumidification components based on deviation from setpoint by placing half of the selected value on each side of the humidity-control setpoint. A smaller number causes faster reaction to humidity changes.

Humidity Setpoint

Humidity level by adding moisture to or removing moisture from the air.

3.1.8 Humidity Control

Humidity control refers to the cooling unit's response to programmed setpoints and sensed humidity conditions.

Vertiv™ Liebert® iCOM™ controls humidity based on temperature and humidity sensor readings. The requirement is expressed as a percentage (%) and is calculated using the selected humidity control type.

Humidity Proportional Band

Use the proportional and deadband parameters to control how your cooling unit(s) respond based on the calculated need for humidification/dehumidification. As the return air humidity deviates from the humidity setpoint, Liebert® iCOM™ responds with a humidification or dehumidification capacity of 0% to 100% in 1% increments.

Figure 3.3 below, illustrates humidity control using:

- 50% setpoint
- 8% proportional band
- No deadband

The proportional band is divided evenly on each side of the setpoint.

- 0% humidifying capacity is required at the humidity setpoint.
- The humidifier starts operating when the humidification requirement reaches 100% and continues to operate until the humidification requirement drops to 0%. During this period, the display shows 100% humidification
- The dehumidifying capacity responds in the same way as the return air humidity rises above the setpoint. Dehumidification is accomplished by a request for cooling that activates as soon as the required dehumidifying capacity reaches 100% and continues operating until the required dehumidifying capacity drops to 0%. During this period, the digital compressor loading scales between a minimum percentage (advanced setting: A557) and 100% depending upon required dehumidifying capacity. The display always shows 100% dehumidification.

Figure 3.3 Humidity Control Without a Deadband

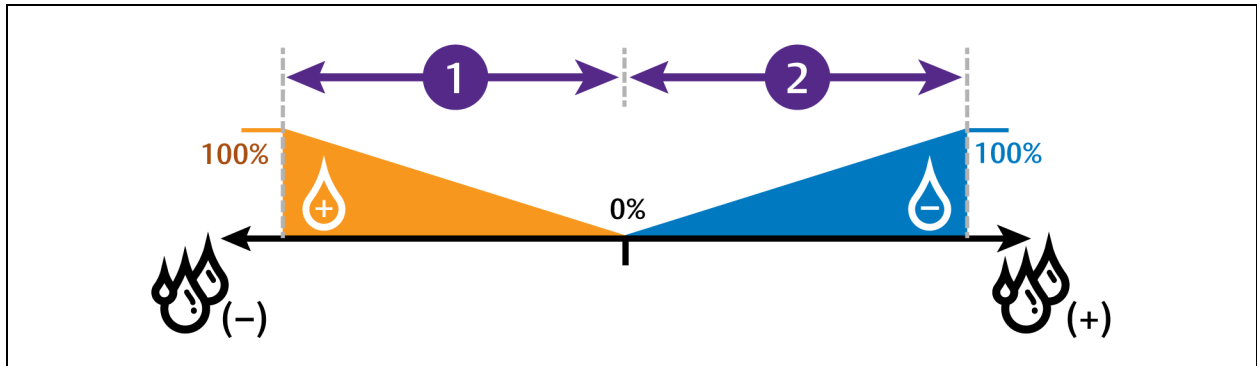

Item	Description
1	½ of proportional band.
2	½ of proportional band.

Humidity Deadband

A deadband widens the setpoint to prevent small changes in humidity from activating humidifiers, compressors and valves and cause excessive component cycling.

Figure 3.4 below, illustrates humidity control using:

- 50% setpoint
- 8% proportional band
- 2% deadband

Like the proportional band, the deadband is also divided evenly on each side of the setpoint.

- 0% cooling capacity is required from 49% to 51%.
- Below 49%, humidification operates according to the humidity proportional band.
- Above 51%, dehumidification operates according to the humidity proportional band.

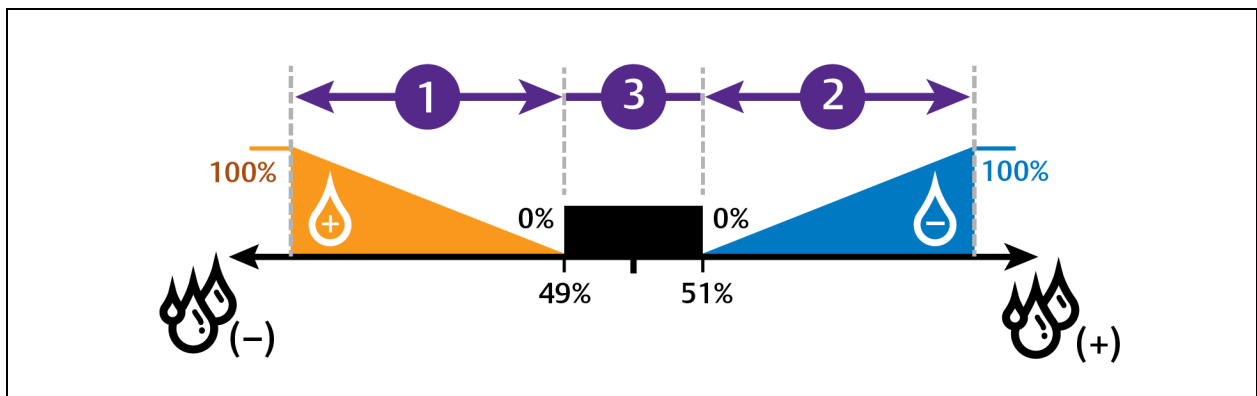

Figure 3.4 Humidity Control with a Deadband



Item	Description
1	½ of proportional band.
2	½ of proportional band.
3	Deadband.

3.1.9 Configuring Fan Setpoints

Configures fan speed control to operate independent of compressor loading (decoupled mode).

1. Touch , then  > *Setpoints* > *Fan Control*. The FAN CONTROL secondary panel opens.
2. Adjust the setpoint options, then touch *Save*. The setpoint is updated.
 - Touch *Cancel* to discard the changes.

NOTE: Depending on the type of thermal management unit, included components, and control settings of your system, all of the options listed may not be available on your Vertiv™ Liebert® iCOM™ display.

Fan Control Options

Airflow Calibration

Maximum allowed fan output voltage.

Fan Control Sensor

Selects the sensor that controls automatic fan speed, see [Automatic Fan Speed Control](#) on the facing page,

– or –

Selects manual control, see [Manual Fan Speed Control](#) on the facing page.

Options are:

- Remote: Air flow/fan speed is adjusted based on reading from a wired, remote temperature sensor. If Remote is selected for the Temperature Control Sensor, then this fan control option defaults to Remote. See [Configuring Temperature Setpoints](#) on page 23.
- Return: Air flow/fan speed is adjusted based on reading from the wired, return air temperature sensor. If Return is selected for the Temperature Control Sensor, then this fan-control option defaults to Return, see [Configuring Temperature Setpoints](#) on page 23.
- Manual: Air flow/fan speed is adjusted using a building management system.
- PI: Regulation is based on proportional and integral terms. Provides best temperature control and helps avoid fan speed oscillation.
- Adaptive PID: Auto-tuning PID control loop, can be set for cooling or fan speed.

Fan Delta

Fan temperature setpoint, it is the temperature difference compared to the cooling setpoint.

Fan Speed Proportional Band

Adjusts the fan speed based on the deviation from the setpoint. A smaller number causes faster reaction to temperature changes.

Fan Speed Integration

Adjusts fan speed based on time away from the setpoint to maintain accurate temperature control.

Maximum Fan Speed

Maximum percentage at which the fans will operate.

Minimum Fan Speed





Minimum percentage at which the fans will operate.

3.1.10 Manual Fan Speed Control





In Manual fan control mode, the speed of the motor can be set in one of the following ways:

- The manual (fixed) fan speed may be set via Vertiv™ Liebert® iCOM™.
- Hard-wired analog input (input-signal types including 4 to 20 mA, 0 to 10 VDC, and 0 to 5 VDC) and a factory supplied isolator to ensure reliable communication.
- Remotely using a Liebert® IntelliSlot™ card.

Setting Manual Fan Speed Control via Analog Input

1. Touch , then  > *Setpoints* > *Fan Control*, set *Fan Control Sensor* to **Manual**, then touch *Save*.
2. Touch , then  > *Auxiliary Device Setup* > *Analog Input*.
3. On ANALOG INPUTS, touch *Customer Analog Inputs* to expand it, then touch the analog-input device corresponding to fan speed control.
4. On the ANALOG INPUT PROPERTIES panel, adjust the properties, then touch *Save*.
 - Touch *Cancel* to discard the changes without saving.

Setting Manual Fan Speed Control via BMS

1. Touch , then  > *Setpoints* > *Fan Control*, set *Fan Control Type* to **Manual**, then touch *Save*.
2. Touch , then  > *BMS & Teamwork Setup* > *BMS Setup*.
3. On BMS SETUP, touch *Control Settings*.
The CONTROL SETTINGS secondary panel displays:
 - In *Fan Control Sensor*, select **Manual**.
 - In *BMS Fan Speed Local Override*, select **No**.
 - Touch *Save*.
 BMS control of fan speed is set, and the BMS set fan speed is displayed on the Fan Speed slider.

NOTE: Set the fan speed via BMS by writing to the Fan Speed Maximum Set Point monitoring point. For details, see SL-28170 IntelliSlot™ Reference Guide found at <https://www.Vertiv.com/en-us/support/>.

NOTE: Local adjustments to fan speed are overridden when remote/BMS fan speed control is set.

3.1.11 Automatic Fan Speed Control



Temperature sensors can control fan speed using one of two modes based on the type of sensor selected as the fan control sensor: return, or remote, see **Table 3.2** on the next page. Control is based on the selected sensor for both fan control and temperature control and their setpoints as follows:

- Coupled: The fan control and temperature control sensor selection is the same. When coupled, fan speed is determined by the temperature setpoints.

Table 3.2 Fan Speed Controlling Sensor Options

		Temperature Control Sensor Selected	
		Remote Sensor	Return Sensor
Fan Control Sensor selected	Remote Sensor	Coupled	N/A
	Return Sensor	NA	Coupled

To Set Parameters for Automatic Fan Speed Control



1. Touch , then  > *Setpoints* > *Fan Control*,
 - Set *Fan Control Type* to **Manual**
 - Select a *Fan Control Sensor*.
 - Adjust the setpoint options, then touch *Save*.

Sensor based fan speed control is set.

2. Touch *Temperature Control*.
3. On the TEMPERATURE CONTROL secondary panel:
 - Select a *Temperature Control Sensor*.
 - Adjust the setpoint options, then touch *Save*.

3.1.12 Scheduling Sleep Times for Thermal Management Units

Unit sleep schedules turn off units during low demand as long as return temperature remains below the alarm threshold.

1. Touch , then  > *Scheduler* > *Unit Sleep Schedule*. The TASK PROPERTIES panel opens.
2. Adjust the schedule settings, and touch *Save*. The schedule is set up.
 - Touch *Cancel* to discard the changes.

Unit Sleep Schedule Task Properties Options

Interval 1/2

Start and finish time of day that sleep mode operates.

Interval Day

Selects days on which sleep mode operates for the intervals specified in Interval 1 and Interval 2.

Sleep Mode

Enable/disable sleep schedule. When checked, the schedule is run. When not checked, the scheduling parameters are ignored.

Timer Mode Type

Selects unit operation when in sleep mode. Values are:

- Unit Off: The unit stops (fans are off).
- Deadband: The unit operates in a limited capacity (fans are on) based on an additional deadband added to the temperature deadband.

Timer Reset

Selects whether or not the sleep-mode timer resets.



Whole Day

Selects specific days on which sleep mode is active for the entire day when the schedule is enabled.

3.2 Setting General Thermal Management Unit Options

NOTE: Depending on the type of thermal management unit, included components, and control settings of your system, all of the options listed may not be available on your Vertiv™ Liebert® iCOM™ display.

3.2.1 Setting Miscellaneous Options

1. Touch , then  > *Options Setup* > *Misc Settings*. The MISC SETTINGS panel displays.
2. Make adjustments as needed and click *Save*. The option settings are updated.
 - Touch *Cancel* to discard the changes without saving.

NOTE: Depending on the type of thermal management unit, included components, and control settings of your system, all of the options listed may not be available on your Liebert® iCOM™ display.

Miscellaneous Cooling Unit Settings Options

Auto Restart Enable

When enabled, the cooling unit returns to the status at which it was operating when input power returns after a power failure. (ON if it was powered on and OFF if it was powered off before the failure.) See [Automatic Restart after Power Failure](#) on page 39.

Cascade after Remote On

Upon a remote request for all units to start, selects whether or not the units start one after another by the Cascade Units Delay set in [Teamwork Modes](#) on page 63, see the [Teamwork Control Options](#) on page 64.

Display Off Enabled

On this cooling unit, sets whether or not the unit powers on/off when the on/off button on the Liebert® iCOM™ display is used.

- No: On and off requests via the display are ignored.
- Yes: Unit powers on/off when requested via the display.

Free Cool Capacity Transition Filter

Selects how quickly capacity changes between modes of operation to avoid overshooting during the transition.

- Only a factory-trained service technician should adjust this setting.

K11 Active On

Selects the action of the activated K11 (warning) relay. Options are:

- Dehum: Dehumidification is on.
- Warning: A warning is active.
- Emergency Pwr: Emergency power is on.
- Freecooling: Free cooling is on.
- FC Start: Free cooling is in the start phase or is on.

K11 (WA Relay) and AL Relay

Sets action of the alarm and warning relays.

- Direct: Open when power is applied to the control.
- Reverse: Closed when power is applied to the control.

Loss of Power Auto Reset Delay

Selects the length of time that a Loss of Power event (that triggers after a power cycle that occurs when the cooling unit is operating) is active when power is restored. When the delay time elapses, the event resets and is cleared automatically.

Operation at Temp Control Sensor Failure

Selects cooling unit operation in the event that the control temperature sensor fails.

- Shut down: The unit shuts down on sensor failure.
- Cooling: The unit continues operation based on the select Temp Control Sensor Failure Cooling Mode.

Restart at BMS Off and Disconnected

Selects the cooling unit's response/action when the BMS is disconnected.

- No: Unit remains in a monitoring-off state.
- Yes: Unit may power on from a monitoring off state.

Single Unit Auto Restart

Selects time elapsed (in seconds) before unit restarts when Auto Restart Enable is enabled.

Temp Control Sensor Failure Cooling Mode

Unit operation when Cooling is selected at control temperature sensor failure.



- Hold: Holds the last call for cooling. That is, continue operating at same capacity.
- Full: Activates full cooling, 100% capacity.

Warning Activates Alarm Relay

When enabled, a warning event activates the common alarm relay.

3.2.2 Automatic Restart after Power Failure



Set the cooling unit to return to the status at which it was operating when input power returns after a power failure. (ON if it was powered on and OFF if it was powered off before the failure.)

1. Touch , then  > *Options Setup* > *Misc Settings*.
The MISC SETTINGS panel displays.
2. Set *Auto Restart Enable* to **Yes**, and use the slider to set the number of seconds to delay before restart, then touch *Save*.
Automatic restart is enabled.
 - Touch *Cancel* to discard the changes without saving.

3.2.3 Setting Fan Options

Air flow is adjustable via Vertiv™ Liebert® iCOM™ manually using a BMS or automatically using locally installed temperature sensors.

NOTE: Thermal management units ship with the factory setting Return Sensor for the temperature control sensor and the fan speed control sensor.

1. Touch , then  > *Options Setup* > *Fan Settings*.
The FAN SETTINGS panel displays.
2. Make adjustments as needed and click *Save*.
The option settings are updated.
 - Touch *Cancel* to discard the changes without saving.

NOTE: Depending on the type of thermal management unit, included components, and control settings of your system, all of the options listed may not be available on your Liebert® iCOM™ display.

Fan Settings Options

Airflow Calibration

Maximum allowed fan output voltage.

Allow Fan Modulation with Comp

Enables/disables fan modulation with compressor operation. Values are:

- No: Fan speed ramps to STD when a compressor starts operating.
- Yes: Fan speed modulates based on CFF while compressor operates.

Dehumidification Fan Speed

Maximum fan speed when dehumidification is in progress, assisting with the dehumidification process.

Fan Backdraft Mode

Enables/disables fan operation in back-draft mode.

Fan Shutdown Delay Timer

Length of time that the fan continues to operate after the cooling unit is turned-off via the display, local control or the BMS.

- The delay timer does not apply when the unit is turned off remotely.

Fan Speed at Unit Start

Speed at which the fans run on unit start up.

Fan Speed at Unit Start Timer

Length of time fans run at the speed selected in Fanspeed at unit start.

Fan Speed Filter at 0%

Decreases the rate at which the fan speed changes when close-to or at the temperature setpoint to avoid undershooting the setpoint.

Fan Speed Filter at 100%

Increases the rate at which the fan speed changes for a quicker reaction of fan speed at high temperatures.

Fan Speed Reposition Delay

Length of time before fan speed can decrease, allowing temperature to stabilize before the change occurs.

Fan Speed Reposition Mode

Sets a one-time delay that allows the fan to maintain current speed when a call to increase or decrease is made to allow the temperature to stabilize.

Fan Speed Transition Filter

Sets how quickly the fan speed changes between operating modes. Prevents an instant reaction when fans turn on or off and prevents unstable operation.

Max Deceleration Rate

Selects the rate and which the fan speed changes during deceleration.

Maximum Fan Speed

Maximum speed at which the fan will operate.



Minimum Fan Speed

Minimum speed at which the fan will operate.

No Power Fanspeed

Speed at which the fans operate when using emergency power.

3.2.4 Setting Compressor Options

1. Touch , then  > *Options Setup* > *Compressor Settings*. The COMPRESSOR SETTINGS panel displays.
2. Make adjustments as needed and click *Save*. The option settings are updated.
 - Touch *Cancel* to discard the changes without saving.

NOTE: Depending on the type of thermal management unit, included components, and control settings of your system, all of the options listed may not be available on your Vertiv™ Liebert® iCOM™ display.

Compressor Settings Options**Compressor Capacity Filter at 0%**

Decreases the rate at which cooling capacity changes when close to or at the temperature setpoint to avoid undershooting the setpoint.

Compressor Capacity Filter at 100%

Increases the rate at which the cooling capacity changes for a quicker reaction of cooling at high temperatures.



Winter Start Delay

Length of time, in minutes, that a low pressure condition is ignored during compressor start-up. See [Setting Low Pressure Time Delay](#) below.

Setting Low Pressure Time Delay



At compressor start up, a low pressure condition is ignored for a set period to avoid false trips due to bubbles in the refrigerant or another misreading of the low pressure device.

NOTE: The factory default setting is a four minute delay.

1. Touch , then  > *Options Setup* > *Compressor Settings*.
2. Use the *Winter Start Delay* slider to select the number of minutes for the delay, and touch *Save*.

3.2.5 Setting Reheat Options

If the room air temperature becomes too cold, heating is activated based on the temperature proportional band setting. Depending on the type of cooling unit, there are different types of reheat (configured at purchase and set at factory). There may also be one to three stages of reheat, which are also factory set. The only service operation available is setting the number of heat stages.

1. Touch , then  > *Options Setup* > *Reheat Settings*. The REHEAT SETTINGS panel displays.
2. Refer to [Reheat Settings Options](#) below, and [Reheat Control](#) on the facing page to adjust the setpoint options, then touch *Save*.
The option settings are updated.
 - Touch *Cancel* to discard the changes without saving.

NOTE: Depending on the type of thermal management unit, included components, and control settings of your system, all of the options listed may not be available on your Vertiv™ Liebert® iCOM™ display.

Reheat Settings Options

Electric Heat Outputs

Shifts the output steps of the electric heaters.

Electric Heat Staging

Selects the electric heat staging option.

- No. Reheat is not available for Vertiv™ Liebert® Mini-Mate.

Enable Hot Gas Heat

Enables/disables hot gas reheat.

- No: Reheat is not available for Liebert® Mini-Mate.

Reheat Operation

Selects when heating is allowed.

- Dehum: Heating only allowed during dehumidification.
- Normal: Heating allowed during all operating modes.

SCR Control Type

Enables/disables SCR reheat. (May not be included on your cooling unit.) See [Reheat Control](#) below. Values are:

- None: SCR reheat disabled.
- Tight: Use tight control reheat mode.
- Standard: Use standard reheat mode.

Electric Heat Stages

Number of electric stages that may be activated during reheat.

- Liebert® Mini-Mate has single stage reheat.

3.2.6 Reheat Control

If your cooling units are equipped with a heating option, reheat control is directly linked to temperature control in that the heating requirement determined by the temperature proportional band determines reheat operation. See [Temperature Control—Temperature Setpoints and Cooling Operation](#) on page 26.

Electric Reheat

Reheat is controlled by the heating half of the temperature proportional band (below the setpoint). **Figure 3.5** on the next page illustrates single stage electric reheat operation:

- 70° setpoint
- 8° proportional band
- 2° deadband

The proportional band is divided evenly on each side of the setpoint. The deadband is divided evenly on each side of the setpoint.

- From 70° to 69°, 0% heating is required.
- At 65° air temperature (heating demand 100%), electric reheat activates and continues operating until temperature reaches 69° (heating demand 0%).

Figure 3.5 Temperature Control for Reheat—Single Stage Electric Reheat

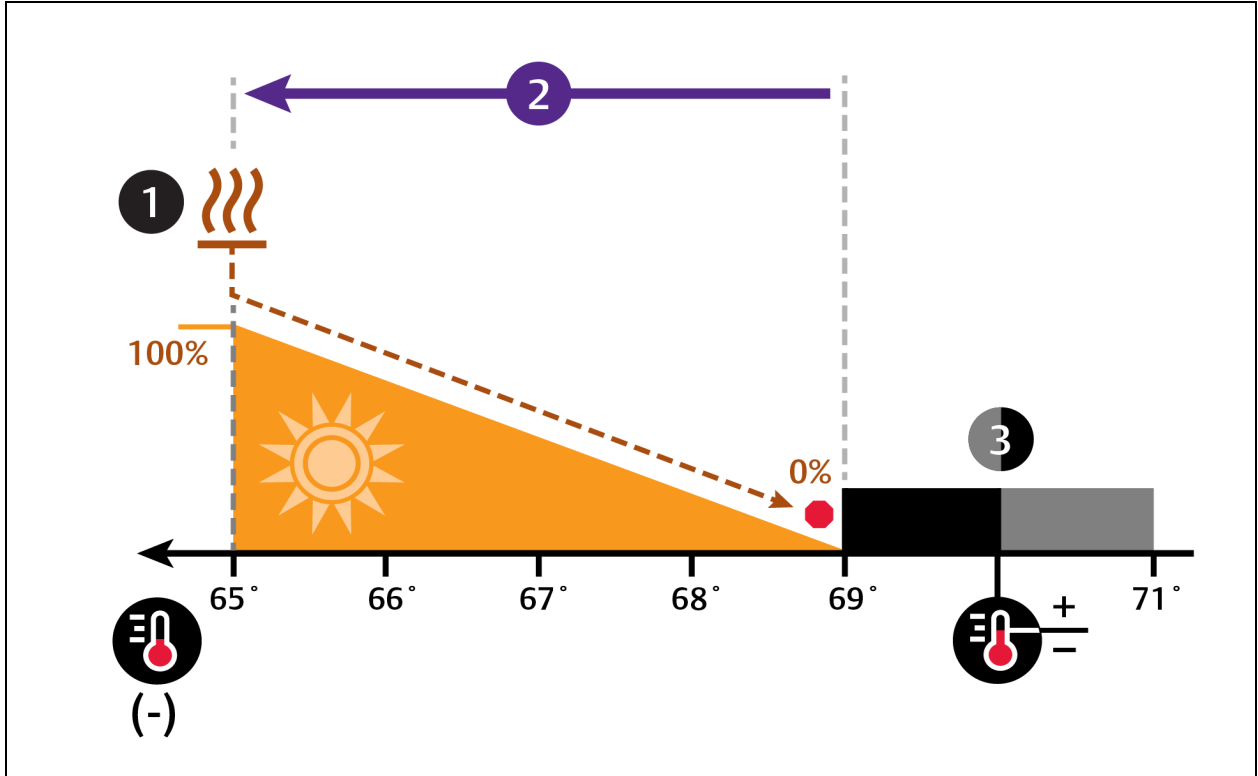

No.	Description
1	Reheat operation begins.
2	½ of proportional band.
3	Deadband.

SCR Reheat

SCR reheat uses pulsed on/off operation to modulate heating capacity to control temperature more precisely than staged, electric reheat. 100% heating capacity is constant operation of SCR reheat. As the temperature proportional band requires more heat, the SCR output adjusts proportionally.

SCR Reheat—Standard Mode

NOTE: Standard SCR Reheat when used in conjunction with variable cooling capacity (such as chilled water, variable speed fans or digital scroll compressors) provides ultimate capacity control and energy efficiency gains.

In standard mode, SCR reheat responds to a 0% to 100% heating requirement based on the temperature proportional band.

Figure 3.6 below illustrates SCR reheat in standard mode as follows:

- 70° setpoint
- 8° proportional band
- No dead band

The proportional band is divided evenly on each side of the setpoint. The deadband is divided evenly on each side of the setpoint.

- At 70° air temperature (heating demand 0%), no heating occurs.
- When temperature decreases below the setpoint, SCR reheat activates, and increases output as the heating demand increases from 0% to 100%.
- As air temperature rises and heating demand decreases, the SCR reduces output and stops operating when 70° (0% heading demand) is reached.

Figure 3.6 Temperature Control for Reheat—SCR in Standard Mode

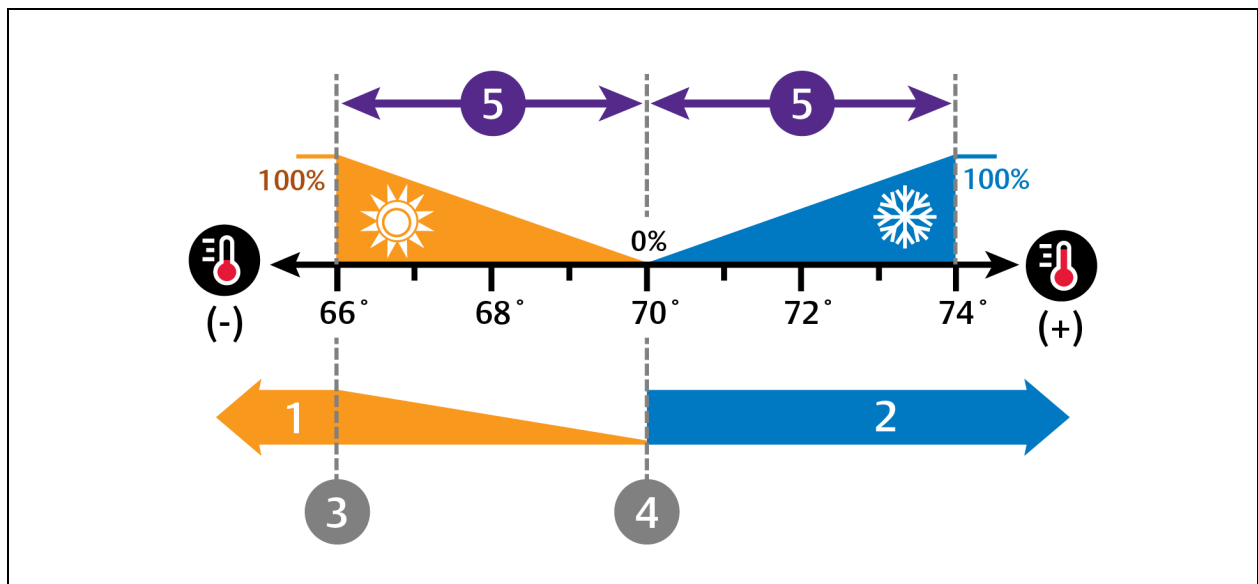



No.	Description	No.	Description
1	SCR reheat operation.	4	SCR reheat stops/begins operating at the setpoint.
2	Compressor operation.	5	½ of proportional band.
3	SCR reheat output is 100%.		

3.2.7 Setting Humidifier Options

The type of humidifier used depends on the cooling unit model and application requirements for your system.

NOTE: Except for externally mounted humidifiers, humidifier operation is limited by the return air temperature. If return air temperature reaches 80°F (26°C) or higher, the humidifier is disabled. The humidifier will not resume operation until the temperature falls to 75°F (24°C) or remains below 80°F (26°C) for 20 minutes.

1. Touch , then  > *Options Setup* > *Humidifier Settings*. The HUMIDIFIER SETTINGS panel displays.
2. Make adjustments as needed and click *Save*. The option settings are updated.
 - Touch *Cancel* to discard the changes without saving.

NOTE: Depending on the type of thermal management unit, included components, and control settings of your system, all of the options listed may not be available on your Vertiv™ Liebert® iCOM™ display.

Humidifier Settings Options

Humidification System Enabled



Enables/disables group-wide (network wide) humidification by the cooling units in the group. Once enabled at the system level, individual units may be enabled using the Humidification Enabled parameter.

Humidification Enabled

Enables/disables humidification at the unit level.

- On-Off: Sends a start-stop command to a remote-mounted humidifier.

3.2.8 Setting Dehumidification Options

1. Touch , then  > *Options Setup* > *Dehumidification Settings*. The DEHUMIDIFICATION SETTINGS panel displays.
2. Make adjustments as needed and click *Save*. The option settings are updated.
 - Touch *Cancel* to discard the changes without saving.

NOTE: Depending on the type of thermal management unit, included components, and control settings of your system, all of the options listed may not be available on your Liebert® iCOM™ display.

Dehumidification Settings Options



Dehum System Enabled

Enables/disables whether or not the compressor/valve is used for dehumidification when humidity is above the setpoint.

Dehum Unit Enabled

Enables/disables dehumidification for the cooling unit.

3.2.9 Setting Q15 Options

1. Touch , then  > *Options Setup* > *Q15 Settings*.
The Q15 SETTINGS panel displays.
2. Make adjustments as needed and click *Save*.
The option settings are updated.
 - Touch *Cancel* to discard the changes without saving.

Q15 Settings Options

Q15 Output Direction

Selects whether the output is normally on or normally off.

Q15 Output Function

Selects the reason for which the digital output is activated. Options are:

- 1: Dehum On
- 3: Reheat On
- 4: Comp On
- 5: Comp 1 On
- 6: Comp 2 On
- 7: Humi On
- 9: Free Cool On
- 10: Damper
- 11: High Temp
- 12: Low Temp

Q15 Output Sensor

Selects a sensor reading to compare to the set threshold that activates Q15 output. Options are:

- 0: Return
- 2: Rem Max
- 3: Rem Low
- 4: Rem Avg

Q15 Output State

Status of Q15 output, ON or OFF.

Q15 Temp Actual

Current value of the sensor selected as the Q15 Output Sensor.

Q15 Temp Output Threshold

Temperature threshold above or below which Q15 output activates.

4 Managing Events: Alarms, Warnings and Messages

Events are notifications of operating status for the cooling unit, its components, and auxiliary devices. All events are recorded in the Event Log, and alarm and warning events are also displayed on the Alarms panel (See [Viewing the Event Log](#) on page 19, and [Viewing Unit Alarms](#) on page 16.)

In some cases, depending on configuration, an alarm event may power off the cooling unit, but not always. However, if a standby unit is configured, all alarm events stop the faulty unit and start the standby unit. Message and warning events do not.

4.1 Event Properties

The ALARMS & EVENTS panel lists all events available on the system. You can view and modify events and the criteria that trigger visual/audible alarms including:

- Critical thresholds
- Time delays
- Enable/disable
- Event type
- Adding custom events

NOTE: Not all event properties may be adjusted, depending on the criticality of the event, which is factory-set.

4.1.1 To Open the Panel

Touch , then  > Alarm/Event Setup.

NOTE: Depending on the type of thermal-management unit, included components, and control settings of your system, the options on your Vertiv™ Liebert® iCOM™ display may differ.

Alarms and Events Panel Fields

Property

Lists groups of events, expanding displays the events in each group. See [Enabling Events and Editing Event Settings](#) on the next page.

Type

Event type. See [Selecting Event Type and Setting Alarm/Warning Notification](#) on page 51.

Ack

Indicates type of acknowledgment required. See [Acknowledging Alarms](#) on page 18. This option is not available with all alarm types.

- Auto: The alarm is acknowledged automatically. It goes away if the situation that triggered alarm event is no longer true.
- Manual: The alarm goes away only when acknowledged, even if the situation that triggered the alarm event is resolved/no longer true.

Reset



Indicates type of reset required for the event.

- Auto: The alarm resets automatically after acknowledgment.
- Manual: The alarm must be reset manually after acknowledgment. See [Acknowledging Alarms](#) on page 18.

This option is not available with all alarm types.

4.2 Enabling Events and Editing Event Settings

In the ALARMS & EVENTS panel, events are grouped into categories for easier management, for example, the factory set remote sensor alarms and humidification/dehumidification events. In some cases, touch the group heading provides edit options for the entire group, like thresholds, delays and enable/disable. Each event includes settings specific for that event and the notification option where event-type and alarm notifications are selected (See [Selecting Event Type and Setting Alarm/Warning Notification](#) on the facing page).

1. Touch , then  > *Alarm/Event Setup*.
The ALARMS & EVENTS panel opens.
2. Scroll or search to find the event, touch the set's heading to display the properties and values for the entire set in the EDIT panel.
– or –
Touch an individual alarm or event to display it's specific values in the EDIT panel.

NOTE: To edit the event type and notification, see [Selecting Event Type and Setting Alarm/Warning Notification](#) on the facing page.

3. Use the EDIT panel to adjust the settings for the selected event or group of events.



4.3 Selecting Event Type and Setting Alarm/Warning Notification

Setting notification delays and disabling visual notification prevents nuisance notifications. Customize to notify of critical events on your cooling system.

NOTE: If the event includes a safety function, such as high pressure, low pressure, main fan overload, etc., the safety function executes regardless of event type or notification setting. However, notification timing delays still apply.

Table 4.2 on page 53, lists the default and adjustable notification settings for events.

4.3.1 To Select Event Type and Notification

1. Touch , then  > *Alarm/Event Setup*.
2. Scroll or search to find the event and touch the alarm or event.
3. On the EDIT panel, touch *Notifications*.
The EDIT panel displays the notification properties.
4. Adjust the notification properties described in the [Notification Properties](#) below, then touch *Save*.
The notification is updated.
 - Touch *Cancel* to discard the changes without saving.

Notification Properties

Delay

Time, in seconds, to delay notification after event trigger. Depending on the event, the delay may or may not be adjusted. Table 4.2 on page 53 lists the delays and their default settings.

- If the notification delay for the event is greater than the delay set for the event group, the group's delay includes the event's delay.

Enable

Enables/disables notification. Touch the switch to set ON or OFF.

- When disabled, events are not logged or displayed and visual/audible alarm notifications are not made.

Type

Logging and notification level of the event. **Table 4.1** below, describes the event type and notification it generates. **Table 4.2** on the facing page, lists the default types for events.

Table 4.1 Notification Types

Type	Description
Message	Stored in event log only. No visual or audible notification.
Warning	Listed with a yellow status dot on the ALARMS panel and the LED flashes. See Table 10.1 on page 83, and Viewing Unit Alarms on page 16.
Alarm	Listed with a red status dot on the ALARMS panel, the LED flashes, and the audible alarm sounds. See Table 10.1 on page 83, and Viewing Unit Alarms on page 16.

Table 4.2 on the facing page, lists the default settings for each event.

- Internal delay is factory set and not adjustable. It is the time delay after event trigger that notification is sent.
- Default delay may or may not be adjustable and is added to the internal delay of event notification.
- Type may be adjustable or may be fixed.

NOTE: Depending on customization, some events may not be available on your cooling unit.



Table 4.2 Event Notification Defaults

Event	Internal Delay	Default Delay/Range for Adjustment	Type
MAIN FAN OVERLOAD	2 sec	5 sec/0 – 9999 *	ALM
LOSS OF AIRFLOW	3 sec	3 sec/0 – 9999 *	ALM
CLOGGED FILTERS	2 sec	2 sec/0 – 9999 *	WRN
HIGH ROOM TEMP	1 min. after fan on	30 sec/0 – 9999	Fixed to WRN
LOW ROOM TEMP	1 min. after fan on	30 sec/0 – 9999	Fixed to WRN
HIGH ROOM HUM	1 min. after fan on	30 sec/0 – 9999	Fixed to WRN
LOW ROOM HUM	1 min. after fan on	30 sec/0 – 9999	Fixed to WRN
HIGH TEMP SENSOR A	1 min. after fan on	30 sec/0 – 9999	Fixed to WRN
LOW TEMP SENSOR A	1 min. after fan on	30 sec/0 – 9999	Fixed to WRN
HIGH HUM SENSOR A	1 min. after fan on	30 sec/0 – 9999	Fixed to WRN
LOW HUM SENSOR A	1 min. after fan on	30 sec/0 – 9999	Fixed to WRN
COMP 1 OVERLOAD	Internal Calc.	no	ALM
COMP 1 HIGH PRESSURE	Internal Calc.	no	ALM
COMP 1 LOW PRESSURE	Internal Calc.	no	ALM
DIG SCROLL1 HIGH TEMP	Internal Calc.	no	ALM
EL HEAT HIGH TEMP	5 sec	0 sec/0 – 9999	WRN
WORKING HRS EXCEEDED	0 sec	0 sec/0 – 9999	Fixed to WRN
SMOKE DETECTED	2 sec	2 sec/0 – 9999 *	ALM
WATER UNDER FLOOR	2 sec	2 sec/0 – 9999 *	ALM
COND PUMP-HIGH WATER	2 sec	2 sec/0 – 9999 *	ALM
LOSS OF FLOW	5 sec Reset delay: 10 sec	2 sec/0 – 9999 *	ALM
STBY GLYCOL PUMP ON	2 sec	2 sec/0 – 9999 *	ALM
STANDBY UNIT ON	2 sec	2 sec/0 – 9999 *	ALM
HUMIDIFIER PROBLEM	2 sec	2 sec/0 – 9999 *	ALM
NO CONNECTION w/Unit1	Internal Calc.	-	WRN
UNIT X DISCONNECTED	Internal Calc.	-	WRN
LOSS OF POWER	0 sec	no	ALM
CUSTOMER INPUT 1	2 sec	2 sec/0 – 9999 *	ALM
CUSTOMER INPUT 2	2 sec	2 sec/0 – 9999 *	ALM
CUSTOMER INPUT 3	2 sec	2 sec/0 – 9999 *	ALM

Table 4.2 Event Notification Defaults (continued)

Event	Internal Delay	Default Delay/Range for Adjustment	Type
CUSTOMER INPUT 4	2 sec	2 sec/0 – 9999 *	ALM
CALL SERVICE	2 sec	2 sec/0 – 9999 *	MSG
HIGH TEMPERATURE	2 sec	2 sec/0 – 9999 *	MSG
LOSS OF AIR BLOWER 1	2 sec	2 sec/0 – 9999 *	ALM
REHEAT LOCKOUT	2 sec	2 sec/0 – 9999 *	WRN
HUMIDIFIER LOCKOUT	2 sec	2 sec/0 – 9999 *	WRN
FC LOCKOUT	2 sec	2 sec/0 – 9999 *	WRN
COMPRESSOR(S) LOCKOUT	2 sec	2 sec/0 – 9999 *	WRN
COMP 1 SHORT CYCLE	0 sec	0 – 9999	MSG
No Power	0 sec	0 sec/0 – 9999WRN	
Condensate 1 Failure	0 sec	5 sec/0 – 9999	WRN
Condensate 2 Failure	0 sec	5 sec/0 – 9999	WRN
EC Fan Fault	0 sec	10 sec/0 – 9999	ALM
HIGH SUP TEMP	0 sec	30 sec/0 – 9999	WRN
LOW SUP TEMP	0 sec	30 sec/0 – 9999	ALM
REDUCED ECO AIRFLOW	0 sec	3 sec/0 – 9999	WRN
ECO HI TEMP OVERRIDE	0 sec	10 sec/0 – 9999	WRN
TEMP CTRL SENSOR FAIL	0 sec	3 sec/0 – 99999	ALM
HIGH DEW POINT	0 sec	30 sec/0 – 9999	WRN
LOW DEW POINT	0 sec	30 sec/0 – 9999	WRN
HI DEW POINT SENSOR A	0 sec	30 sec/0 – 9999	WRN
LOW DEW POINT SENSOR A	0 sec	30 sec/0 – 9999	WRN
HIGH REMOTE SENSOR	0 sec	30 sec/0 – 9999	WRN
POWER "A" FAILURE	0 sec	10 sec/0 – 9999	ALM
POWER "B" FAILURE	0 sec	10 sec/0 – 9999	ALM
AIRFLOW SENSOR FAILURE	0 sec	10 sec/0 – 9999	WRN
HUM CTRL SENSOR FAIL	0 sec	30 sec/0 – 9999	WRN
LOSS OF FLOW	0 sec	5 sec/0 – 9999	ALM
DAMPER FAILURE	0 sec	10 sec/0 – 9999	ALM
BMS DISCONNECTED	0 sec	ENABLED/DIS - ENAB	WRN

4.4 Enabling the Audible Alarm Notification

1. Touch , then  > *Display Options* > *Display Properties*. The UNIT DISPLAY panel opens.
2. Touch the *Alarm Buzzer Pattern* value, and select a pattern from the drop-down list.
 - Selecting *None* disables the audible notification.
3. Touch *Save* to save the property settings.
 - Touch *Cancel* to discard changes.

4.5 Remote Alarm Device and Customer Input Events

Remote alarm devices are various sensors and detectors outside the cooling unit that provide information about conditions and situations that may affect operation. RAD include smoke detectors, filter condition, valve status.

Included in the remote alarm devices (RAD) option are up to three customer input events depending on cooling unit configuration. See [Setting Up Customer Input Events](#) below.



RAD and customer input notifications are set in the same way as other events. See [Selecting Event Type and Setting Alarm/Warning Notification](#) on page 51.

4.5.1 Setting Up Customer Input Events

Input devices must be wired to Terminal 24 through a dry contact to locations 50, 51 and 56 for alarms 1 through 3, respectively (For the terminal location, refer to the cooling unit electrical schematic and installation manual). **Table 4.3** below, maps the customer input to the RAD.

Table 4.3 Customer Input Terminals to RAD Terminals

Customer Input	Customer Input Terminal	RAD Number	RAD Terminal
1	24	1	50
2	24	2	51
3	24	3	56
4	24	4	56

1. Touch , then  > *Alarm/Event Setup* > *Remote Alarm Device Input*. The EDIT panel opens.
2. In *Customer Input X* (where *X* is the input number), select the input type that best describes the wired device/input, see **Table 4.4** on page 57.
3. In *Customer Input X Active When*, select whether the input is active (triggers events) when opened or closed.
4. Once input(s) are set, touch *Save*. The customer input settings are saved.

Customer Input Options

Customer Input X

Selects the customer wired input, where X is the input number. See [Customer Input Options](#) on the facing page, for a description of available values.

Customer Input X Active When

Selects when the input triggers an event. Options are:

- Opened: Events are triggered when the contacts across the corresponding RAD terminal strip are open.
- Closed: Events are triggered when the contacts across the corresponding RAD terminal strip are closed.

NOTE: Depending on customization, some events listed in Table 4.4 below, may not be available with your system.

Table 4.4 Customer Input Options

Input	Action/Description
Smoke	Event only.
Water Alarm	Event only.
C PMP Alarm	Event only.
Flow Alarm	Event only.
Stdby G Pmp	Event only.
Stdby Unit	Event only.
C-Input 1	Event only.
C-Input 2	Event only.
C-Input 3	Event only.
C-Input 4	Event only.
Rht Lockout	Event + Electric heaters disabled.
Hum Lockout	Event + Humidifier disabled.
Rht+Hum Lock	Event + Electric heaters and humidifier disabled.
Comp Lockout	Event + Compressor(s) disabled w/o pump down.
Call Service	Event only.
High Temp	Event only.
HTRJ VFD	Activates the HEAT REJ VFD ALARM. No other function.
HTRJ SPD	Activates the HEAT REJ SPD ALARM. No other function.
FIRE ALARM	Event + Shuts-down the unit.
2ND SETPOINT	No event, but switches to the second setpoint.
Emergency Power	Event + Disables unit.
LSI	Event + Activates humidifier-problem Alarm and stop filling bottle when full.
COND 1 FAIL	Event only.
D-SCROLL RED	Event + Reduces requested compressor capacity by 20%.
SWAP VALVE	No event -Active X valve closes and Y opens/Inactive Y closes and X opens. See 7.3 - Custom Dual Chilled Water Valve Staging.
EC FAN FAULT	Event + Set analog output to 10 V.
ECO AIRFLOW	Event + Reduce Liebert® air economizer air flow.
DAMPERSWITCH	Damper + End switch.
POWER A	Event only.
POWER B	Event only.

This page intentionally left blank

5 Unit to Unit (U2U) Networking

Vertiv™ Liebert® iCOM™ controlled thermal management units connected in an Ethernet unit-to-unit (U2U) network are able to efficiently cool and control humidity in the conditioned space by exchanging data in several modes of operation.

U2U networking is required to set up and control the following operating features:

- Teamwork
- Standby (lead/lag)
- Rotation
- Cascading

NOTE: The U2U network must be separate from other networks. Use a communication card, such as a Liebert® IntelliSlot™ Unity, to communicate securely between your buildingmanagement system or other networks.

5.1 Preparing for U2U Group Set Up

Cooling units in the network will be assigned to groups, which affects how units function in teamwork, standby, rotation, and cascading operations. Especially in large rooms, it is important to consider several factors before setting up groups to balance cooling unit operation with room conditions.

NOTE: For ease of set up and use, we recommend using only one group unless you have multiple rooms, differing software versions, or different types of cooling units.

1. Make a map of the room and indicate the location of all heat generating devices and cooling units to plan for proper heat load management and cooling-air distribution.
2. Note the type of units by product, model, size, etc.
3. Determine the number of units to network together to ensure proper air flow and environmental control, up to 32 units.
4. Determine number of standby units.
5. Determine if using teamwork, and if so, which mode.
6. Plan U2U address assignments.
 - Refer to the [U2U Control Board Settings](#) on page 61, for guidelines assigning cooling unit control board addresses.
 - Balance/alternate unit address assignments based on room layout and because standby and teamwork operate in numeric order by unit number. **Figure 5.1** on the next page, shows an example layout assignment with half of the cooling units in standby and half operating. Without a plan, adjacent units could be operating or inactive, which may not provide proper heat load balance or efficient use of cooling capacity.
7. Read and record all programmed settings for each of the individual units. See [Backing Up, Importing, Exporting, and Restoring Display Settings](#) on page 79.
8. Verify that network cabling and switches are provided, ready to connect, and labeled by unit at the network switch.

NOTE: Cooling units are factory wired for stand alone operation. Do not connect the U2U network cabling before setting the U2U network configuration/groups. Network communication conflicts and unreliable display readings will result. Configure the network using [Configuring U2U Network Settings](#) on the next page, then refer to [U2U Wiring Connections](#) on page 105, to connect the network cabling and hardware.

Figure 5.1 Example Layout Standby/Operating Unit Address Assignment

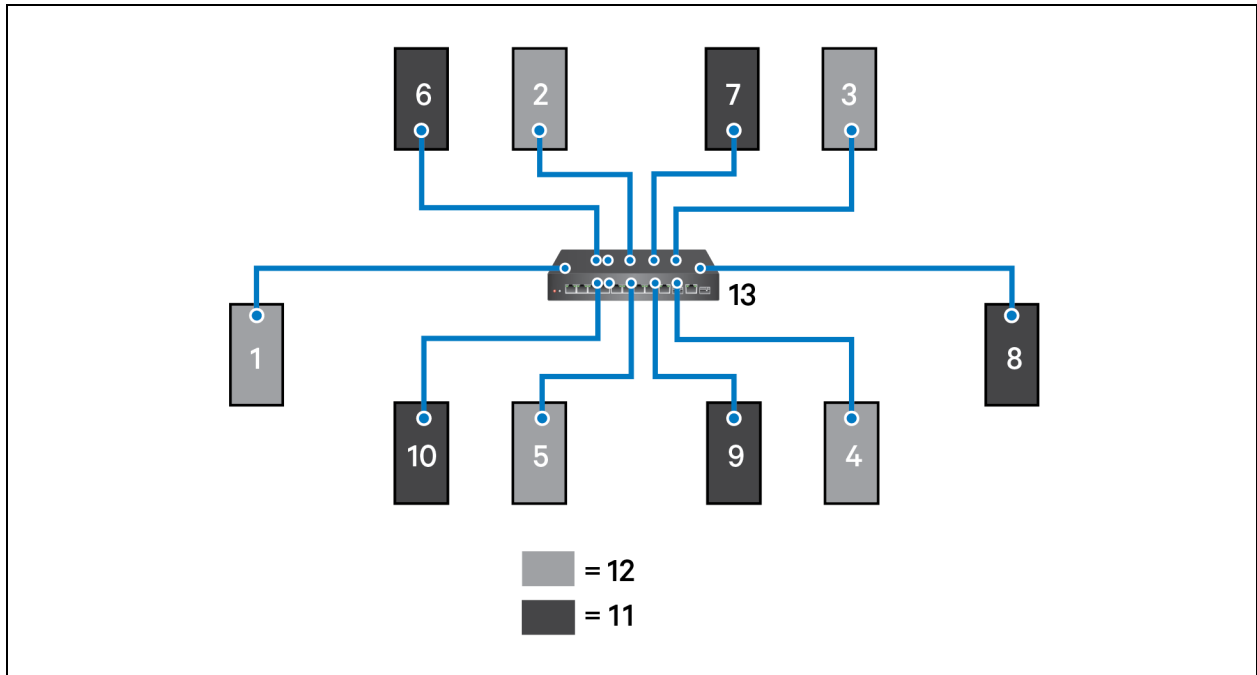



Item	Description
1 to 10	Assigned address of the thermal management unit.
11	Operating units.
12	Units on standby
13	Network switch

5.2 Configuring U2U Network Settings

The U2U NETWORK SETTINGS configure Vertiv™ Liebert® iCOM™'s unit-to-unit communication and includes

information buttons, , that display popup field descriptions. The panel also indicates issues with the network settings. For resolution, see [Troubleshooting Network Settings Issues](#) on page 62.

5.2.1 To Configure U2U Networking

1. Touch , then  > *BMS & Teamwork Setup* > *U2U Setup*. The U2U NETWORK SETTINGS panel opens.
2. Touch the field to edit. The keypad opens.

3. Type the entry and touch .
4. When all fields to edit are updated, touch *Save & Restart*.

NOTE: Depending on the changes made, the *Save* button updates to indicate the components that need rebooted or restarted. If the control board reboots, the cooling unit suspends operation for 60 seconds, then resumes operating.

U2U Control Board Settings

Broadcast

Logical address at which connected units receive datagrams.

NOTE: Messages sent to the broadcast address is typically received by all network-attached hosts.

CB Firmware Version

Display configuration based on the firmware version of the control board. Depends on your cooling unit as follows:

- PA-2.06 = Vertiv™ Liebert® CW/Vertiv™ Liebert® DS, Vertiv™ Liebert® DSE, Vertiv™ Liebert® PDX/PCW, Vertiv™ Liebert® Mini-Mate

Gateway

Routes data and acts as proxy server/firewall for control board during network set-up. Display and control board must be identical on the U2U network.

IP Address

Network address of the control board.

NOTE: Last three digits must be a unique value and need not be sequential. However, we recommend that they match the U2U address for easier reference later.

Netmask

Divides IP addresses in subnet and specifies network available to hosts for the control board.

MAC Address

Unique, read-only identifier of the control board Ethernet device.

U2U Address

Unique identifier for each control board on the U2U network. Address range is 1 to 32 and must be consecutive from the previous control-board address in the U2U group. This is the address used for standby/lead lag and cascade operation, see [Example Layout Standby/Operating Unit Address Assignment](#) on the previous page.

NOTE: We recommend matching the U2U address to the last three digits of the IP address for easier reference later.

U2U Group

For the control board, selects the zone/group with which the unit will be configured in teamwork/standby/rotation scenarios.

NOTE: Units with a specific thermal area of influence should be assigned to the same zone/group, typically when a network spans separate rooms rather than by aisles. Groups are also handy when cooling units vary by cooling type, compressor type, or version of Vertiv™ Liebert® iCOM™ firmware and otherwise do not operate together efficiently or at all.

5.2.2 Troubleshooting Network Settings Issues

At the bottom of the U2U NETWORK SETTINGS panel, an Issues button indicates whether or not there are problems with the network settings. The button indicates the number of issues and changes color when a problem exists, see **Table 5.1** below.

Table 5.1 Issues Button Status Colors



Color	Description
Green	No problems. Number of issues is zero.
Red	Problem(s) detected. Number of issues displays.

To View Network Issues

1. When an issue is indicated, touch the Issues button on the U2U NETWORK SETTINGS panel. The ISSUES dialog opens.
2. Note the problems, close the dialog, then address the issue:
 - Touch the setting to correct. The onscreen keyboard opens.
 - Make adjustments and touch Go.
 - Continue making corrections until no problems are indicated.
3. Verify that U2U communication is established, then touch Save.

NOTE: Depending on the changes made, the Save button updates to indicate the components that need to be rebooted or restarted. If the control board reboots, the cooling unit suspends operation for 60 seconds, then resumes operating.

5.2.3 Modifying U2U Network Settings

1. Touch , then  > *BMS & Teamwork Setup* > *U2U Setup*. The U2U NETWORK SETTINGS panel opens.
2. Touch the setting to edit and make adjustments, then touch .
3. Verify that U2U communication is established, then touch Save.

NOTE: Depending on the changes made, the Save button updates to indicate the components that need to be rebooted or restarted. If the control board reboots, the cooling unit suspends operation for 60 seconds, then resumes operating.

6 Teamwork, Standby, and Rotation for Cooling Units

Vertiv™ Liebert® iCOM™ U2U communication via private network and additional hardware (see [Unit to Unit \(U2U\) Networking](#) on page 59) allows the following operating features for the cooling units:

- Teamwork
- Standby (Rotation)
- Cascade

6.1 Continuous Control with Virtual Master

The Virtual Master function maintains smooth control if group communication is compromised. In these operating configurations, a lead (master) unit is in charge of component staging in teamwork mode, unit staging, and standby rotation. If the lead unit gets disconnected, Liebert® iCOM™ automatically assigns a virtual master, which assumes the responsibilities of the lead unit until communication is restored.



6.2 Teamwork Modes

When Liebert® iCOM™ controlled thermal management units are connected to a network in a group or team, use teamwork to optimize performance and efficiency depending on the mode chosen and its application.

In a panel with Status content, the Teamwork mode icon indicates the mode selected, **Figure 6.1** on the next page. Touching the icon displays the Teamwork dialog from which you can access the teamwork control settings.

6.2.1 To Set Up Team Work

1. Touch the Teamwork mode icon, then touch *Edit* on the teamwork dialog.
– or –

Touch  , then  > *BMS & Teamwork Setup* > *Teamwork / Standby* > *TeamworkMode*.

2. Select the mode from the *Teamwork Mode* drop down in the TEAMWORK MODE CONTROL panel. The TEAMWORK/STANDBY panel opens.
3. Touch *Save*. Teamwork mode is set.
 - Touch *Cancel* to discard changes.

Figure 6.1 Teamwork Icons

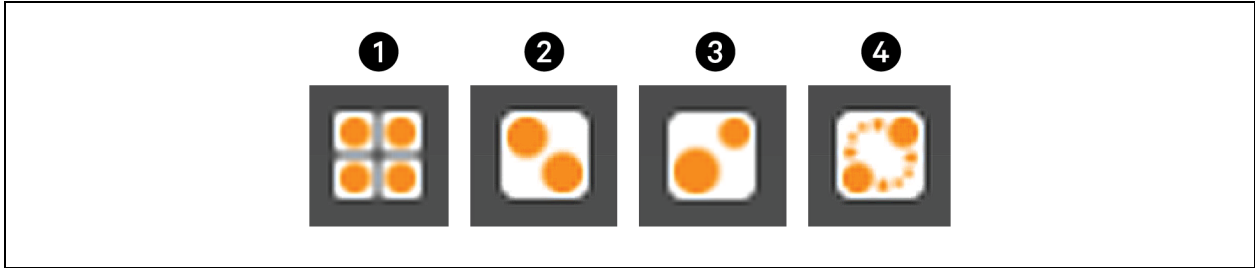

Item	Description
1	No teamwork.
2	Mode 1 - Parallel teamwork
3	Mode 2 - Independent teamwork
4	Mode 3 - Optimized aisle teamwork NOTE: Not applicable to Liebert® Mini-Mate units.

NOTE: Depending on the type of thermal management unit, included components, and control settings of your system, all of the options listed may not be available on your Vertiv™ Liebert® iCOM™ display.

Teamwork Control Options

Cascade Units

Stages on standby units based on room temperature/humidity load. Available in Teamwork mode 1:

- Teamwork mode 1 Parallel options are:
 - Yes: standby units cascade on, based on a call for heating, cooling, humidification, or dehumidification.
 - Cool/heat: Standby units cascade on with a call for heating or cooling only.
 - Cooling: Standby units cascade on with a call for cooling only.

Cascaded Units Delay

Length of time in minutes to delay the activation of a standby unit after the previously activated unit starts, to prevent staged cascaded units from starting too close together or at the same time.

Cascaded Units Min Run

Length of time in minutes that an cascade on unit must run before powering off.

Cascaded Units Off Delay

Length of time, in minutes, to delay powering off a cascaded unit after fan speed drops below the *Stop Next Unit @ SYS Fanspeed* setting.

Cascaded Units Quick Start

After a power cycle of the master unit, identical to Cascaded Units Delay except that it should be shorter to get units to start more quickly after a power cycle.

- This delay remains in effect until all cascaded units have been restarted, then the delay reverts to setting of Cascaded Units Delay.

Max. Intermediate System Speed

Limits the fan speed of the group until all units in cascade are powered on. Once all units are operating, the fan speed may increase beyond this setting.

Number of Connected Units

Number of units connected in the group if U2U networked.

Start Next Unit at SYS Fan Speed

Fan speed at which the next cascaded unit is powered on.

Stop Next Unit at SYS Fan Speed

Fan speed at which the next cascaded unit is powered off. Unit power off may be delayed by *Cascaded Units Off Delay*.

Based On

Select the way the sensor readings from each cooling unit in the group are used to control temperature and humidity. Options are:

- Maximum: Based on the highest reading from a sensor in the group.
- Average: Based on the average readings from the sensors in the group.

Type

Teamwork mode to use for the group.

6.2.2 No Teamwork—Multiple Zones in One Room

When a teamwork mode is not used, cooling units work independently based on their own sensors. Standby and unit rotation may be used, but cascading cannot.

6.2.3 Teamwork Mode 1—Parallel Operation

In Teamwork mode 1, fan speed and cooling capacity are ramped up in parallel, which means that all units operate identically.

Teamwork Mode 1 is best for small rooms with balanced heat loads. A master unit collects the controlling readings for temperature and humidity from all the operating (fan on) units in the group, then determines the average or worst-case reading, and sends operating instructions to efficiently distribute cooling capacity across available units.

In Teamwork Mode 1, most parameters are shared and, when set in any unit, are set in all units in the group.

6.2.4 Teamwork Mode 2—Independent Operation

Teamwork Mode 2 works well for most applications, and best in large rooms with un-balanced heat loads by preventing units in a group from operating in opposing modes, some cooling and some heating. All temperature and humidity parameters are shared by the group. The master unit monitors all available unit sensor readings and determines the demand for cooling, heating, humidification and dehumidification, then sends operating instructions to address the greatest demand.

In Teamwork Mode 2, the setpoints for all units must be identical. The proportional band, deadband, and related settings may differ by unit. Fan speed is modulated per unit. Rotation and cascading is not available, so expect uneven distribution of work hours.

6.3 Assigning Cooling Units to Standby (Lead/Lag)

Standby assigns some units to operate while others are on standby, meaning a unit is idel by ready to become active in the event of an alarm condition in one of the operating units or based on a rotation schedule.

When a unit is in standby mode, fan(s) are off and no cooling occurs. In multiple cooling unit systems, assigning units to standby lets you:



- Configure redundancy in case of failure scenarios (stand by).
- Manage cooling unit run time (lead/lag). See [Setting a Rotation Schedule](#) on the facing page.
- Modulate for very low loads to full design load (to be temperature reactive) by cascading activation of standby units (configured when setting up teamwork mode).

The U2U network has built-in fail over conditions that are automatically employed when standby units have been assigned:

- During single cooling unit or component failure, a standby unit is activated to replace the failed unit.
- Alarm event causes unit shut down, a standby unit is activated. If the activated unit also has an alarm event, the next available standby unit is activated. If all units have an alarm event, and no more standby units are available, a unit with a non-critical alarm event will be activated.

NOTE: Redundancy is employed if units are assigned to standby regardless of the teamwork mode selected, including No Teamwork.

6.3.1 To Set Up Lead/Lag Operation

1. Touch , then  > *BMS & Teamwork Setup* > *Teamwork / Standby*. The TEAMWORK/STANDBY panel opens.
2. Touch *Standby*. The STANDBY CONTROL panel displays.
3. Adjust the settings, then touch *Save*.
 - Touch *Cancel* to discard the changes.

Standby Options

High Temperature Threshold

Temperature at which all standby units are activated.

Number of Standby Units

Number of units in standby mode.

Standby Fan Timer at Reheat/Humidification



Length of time in minutes that the fan continues to operate after the cooling unit enters standby mode if reheat or the humidifier were operating when unit powered off.

Start All Standby Units by High Temperature

When enabled, all units are activated to cool when a high temperature alarm occurs.

6.4 Setting a Rotation Schedule

You can set a rotation schedule to switch operating and standby units to manage run time of the cooling units.

1. Touch , then  > *BMS & Teamwork Setup > Teamwork / Standby*. The TEAMWORK/STANDBY panel opens.
2. Touch *Unit Rotation*. The UNIT ROTATION CONTROL panel displays.
3. Adjust the settings, then touch *Save*. Touch *Cancel* to discard the changes.

6.4.1 Unit Rotation Options

Lead Lag Overlap Timer

Length of time in minutes that cooling units operate in parallel when one begins operating (from standby) and the other goes into standby.

Rotate At

Selects exact time at which rotation occurs. Adjustable, based on 24-hour clock where minutes = 0 to 59, hours = 0 to 23.

Rotate By

Number of positions by which the cooling units rotate. For example, rotate by 3 in a group of 10 units and start with unit 1 operating. At rotation, unit 1 goes to standby and unit 4 activates, then 7, 10, 2, and so on. You can select 1 to 8 units in a single rotation schedule.

Rotate Every

Selects rotation period. Valid values are:

- 12 hours
- 24 hours

Rotate Now

Immediately performs rotation.

Rotation Frequency

Frequency at which rotation occurs. Options include:

- No: Rotation disabled.
- Daily: Rotation occurs every day.
- Every [Day of Week]: Rotation occurs weekly on the same day.
- Monthly [Day of Week]: Rotation occurs monthly on the same day.



6.4.2 Manually Rotating the Operating and Standby Units

You can rotate the operating and standby units outside of the set schedule using Rotate Now.

NOTE: Manual rotation may only be performed at the cooling unit designated as the lead unit, U2U Address = 1, of the group.



NOTE: The Rotate Now button may only be available when a Rotation Frequency is selected. See [Setting a Rotation Schedule](#) on the previous page.

1. At the cooling unit, verify that it is the lead unit of the group:

- Touch , then  > *BMS & Teamwork Setup > U2U Setup*.
- In the CONTROL BOARD column, verify that the *U2U Address* is 1.

If it is the lead unit, continue with step 2.

If it is not the lead unit, find the lead unit and start at step 1.

2. Touch , then  > *BMS & Teamwork Setup > Teamwork / Standby*.
The TEAMWORK/STANDBY panel opens.
3. Touch *Unit Rotation*.
The UNIT ROTATION CONTROL panel displays.
4. Touch *Rotate Now*, then touch *Save*.
The operating and standby units are rotated.

7 External Monitoring and BMS

Vertiv™ Liebert® iCOM™ controlled cooling units are equipped with one Vertiv™ Liebert® IntelliSlot™ plug in slot to communicate with external monitoring systems including Building Management Systems (BMS), Network Monitoring Systems (NMS) and Vertiv™ Liebert® SiteScan™ Web.

NOTE: Because the Liebert® iCOM™ U2U network must be separate from other networks, use external monitoring or BMS to communicate securely between networks.

Liebert® IntelliSlot™ IS-UNITY-DP communication card communicates with up to two third-party protocols to monitor and manage a range of parameters and events and requires Velocity V4 monitoring protocol (standard on firmware versions PA1.04.033 and later). Unity cards deliver:

- Velocity Protocol for Vertiv™ Trellis™, Liebert® SiteScan™ and Vertiv™ Liebert® Nform™.
- Embedded LIFE™ Technology for Remote Service Delivery
- SNMP (v1/v2/v3) for NMS
- HTTP/HTTPS for Web-page viewing
- SMTP for e-mail
- SMS for mobile messaging
- Modbus RTU-Modbus Remote Terminal Unit communication protocol for BMS over an RS-485 serial network (Modbus RTU RS-485)
- Modbus TCP-Modbus Transmission Control Protocol for BMS over Internet or LAN.
- BACnet IP—BACnet over Internet Protocol for BMS over Internet or LAN.
- BACnet MSTP—BACnet Primary-Secondary/Token-Passing communication protocol for BMS over an RS-485 serial network (Modbus MSTP RS-485)

7.1 BMS and Liebert® IntelliSlot™ Settings

When communicating with a building-management system (BMS) with an optional Vertiv™ IntelliSlot™ Unity card or via embedded Unity function, the BMS settings are identical and include:

- Disconnect failsafe
- Manual fan speed control
- Allowing the BMS to change fan speed.
- Backup fan control

7.1.1 Configuring BMS Communication with IntelliSlot Card



Modbus, BACnet, SNMP, SMS and HTTP communication cannot be configured via Liebert® iCOM™. To set up third-party protocols, refer to the appropriate Liebert® IntelliSlot™ Card user manual available at <https://www.Vertiv.com/en-us/support/>.

NOTICE

Risk of loss-of-communication with Liebert® IntelliSlot™ cards. Can cause operational problems.

Do not change the monitoring address of the Liebert® IntelliSlot™ card (set at 3) unless directed by a technical support representative.

To Setup Communication with a Card

1. Touch , then  > *BMS & Teamwork* > *BMS Setup*. The BMS SETUP panel opens.
2. Select *IntelliSlot Card Settings* and refer to [IntelliSlot Options](#) below, to make selections.
3. Touch *Save*.

NOTE: Depending on the type of thermal management unit, included components, and control settings of your system, all of the options listed may not be available on your Vertiv™ Liebert® iCOM™ display.

IntelliSlot Options

Monitoring Address

Address used by an optional, installed Vertiv™ Liebert® IntelliSlot™ card. Factory default is 3.



- Do not modify the monitoring address unless directed to do so by Vertiv™ technical support.

Monitoring Protocol

Protocol used for communication with BMS. Options are:

- Velocity V3: Legacy Velocity communication card
- IGM: IGMNet communication cards
- Velocity V4: Liebert® IS-UNITY card.
- Embedded: Embedded IS-UNITY function
- Embedded & IS V4 both embedded Unity function and Velocity V4 for an optionally installed IS-UNITY card

7.1.2 Setting BMS Control Settings

1. Touch , then  > *BMS & Teamwork* > *BMS Setup* > *Control Settings*. The CONTROLL SETTINGS secondary panel opens.
2. Adjust the settings, and touch *Save*. The settings are configured.

NOTE: Use [Configure Timeout](#) to configure the setpoints used in the event of an outage and BMS takes control. See [Setting BMS Backup Setpoints](#) on the facing page.

NOTE: Depending on the type of thermal management unit, included components, and control settings of your system, all of the options listed may not be available on your Liebert® iCOM™ display.

BMS Control Settings Options

BMS is Connected To

- Velocity
- Analog Input 1-4

BMS Fan Speed Local Override

Enables/disables local override of the fan speed set via BMS.

Fan Control Sensor

Currently-selected fan-control sensor. Must be set to Manual for BMS control. See [Configuring Fan Setpoints](#) on page 33.



Handshake

Sets time-period, in minutes, in which communication between the BMS and Vertiv™ Liebert® iCOM™ must occur.

Maximum Fan Speed

Current fan speed setting (set via fan setpoints or by BMS).

7.1.3 Setting BMS Backup Setpoints

1. Touch , then  > *BMS & Teamwork* > *BMS Setup* > *Configure Timeout* button on the lower-right of the panel. The CONFIGURE TIMEOUT secondary panel opens.
2. Adjust the values, and touch *Save*. The settings are configured.

NOTE: Depending on the type of thermal management unit, included components, and control settings of your system, all of the options listed may not be available on your Liebert® iCOM™ display.

BMS Timeout Settings Options

BMS Backup Fan Operation

Enables/disables BMS operation of the fans during backup operation. Options are:

- Disabled
- BMS Backup Spd
- Coupled
- BMS Backup Set

BMS Backup Temp Setpoint

Temperature that the cooling unit maintains during BMS backup operation.

This page intentionally left blank

8 Configuring Auxiliary Devices

With Vertiv™ Liebert® iCOM™, you can manage and control many devices that work with your thermal management unit(s).

8.1 Configuring Analog Input Devices

1. Touch , then  > *Auxiliary Device Setup* > *Analog Input*.
The ANALOG INPUTS and ANALOG INPUT PROPERTIES panels open.

NOTE: Depending on the type of thermal management unit, included components, and control settings of your system, all of the options listed may not be available on your Liebert® iCOM™ display.

2. Before you touch a specific analog input, the properties panel lists the inputs along with their configuration status:
 - *Factory Std* indicates that the input is configured for a factory-installed component such as a pressure transducer.
 - *Not Config* indicates that the input is configurable.
3. Locate the DIP switches on the control board and program the input type according to **Table 8.1** below.
Figure 8.1 below shows the switch and on/off setting.



Table 8.1 DIP-switch Settings for Analog-input Connection

Analog Input Number		Input #1		Input #2		Input #3		Input #4		Not used	
Control Board Switch Number		1	2	3	4	5	6	7	8	9	10
Analog Input Device Value	0 – 10 VDC	Off	Off	Off	Off	Off	Off	Off	Off	—	—
	0 – 5 VDC	On	Off	On	Off	On	Off	On	Off	—	—
	4 – 20 mA	On	On	On	On	On	On	On	On	—	—

NOTE: Up is on and down is off on the DIP switch. Switches 9 and 10 are not used.

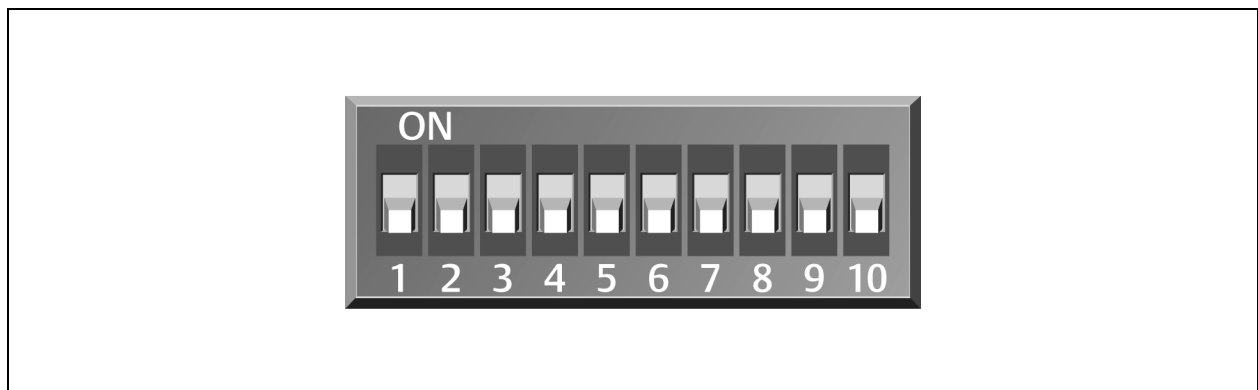
Figure 8.1 Analog Connection DIP Switches on the Control Board



4. On Vertiv™ Liebert® iCOM™, touch , then  > *Auxiliary Device Setup* > *Analog Input* > Customer Analog Inputs, the touch an Analog Input. The ANALOG INPUT PROPERTIES for that device displays.
5. Select the configuration and touch Save. The analog input is configured.



NOTE: The Airflow, Static Pressure and Fluid Flow analog input settings configure factory options and require special instruction. Contact Vertiv™ Technical Support at 1-800-222-5877.

8.2 Wired Remote Sensors

Wired, remote, rack sensors can function as control sensors and, subsequently, provide input individually, at the unit level, or at the system level for temperature control and teamwork functions.

Each wired remote rack sensor has two thermistors/probes. In Individual Sensor mode, the higher temperature reading or the average temperature reading of the two probes can be used. In Unit Sensors mode, some or all of the rack sensor's temperature readings are considered for higher (maximum) or average calculation. For example, setting three sensors as control and average for unit mode, averages the three highest temperature readings.

At the system level, using a U2U network, the same maximum or average calculations can be based on readings from all of the sensors in all of the units in group (including those in standby) using teamwork. See [Teamwork Modes](#) on page 63.

1. Touch , then  > *Auxiliary Device Setup* > *Sensors* > *Wired Remote Sensors* > *Setup*. The set up SENSOR PROPERTIES panel opens.
2. Adjust the settings for the cooling units sensor array, and touch Save. [Wired Remote Sensor Setup Options](#) below, describes the setting options.
3. Touch a specific sensor. The SENSOR PROPERTIES for that sensor open.

NOTE: The sensor number listed corresponds to the DIP switch assignment of the sensor made during installation.

4. Touch *Name*, and use the keyboard to give the sensor a descriptive name.

NOTE: This is the name displayed on the REMOTE SENSORS panel for non-service users.

5. Refer to the [Wired Remote Sensor—Sensor Property Options](#) on the facing page to adjust the remaining settings, and touch Save. The wired-remote sensors for the cooling unit are configured.

8.2.1 Wired Remote Sensor Setup Options

Average Rack Temp

Calculated average of temperature readings from the control sensors.

Individual Remote Sensors Mode

When controlling at the sensor level, selects the method of using the readings from the two temperature thermistors (probes) on the sensor. Options are:

- Maximum: Use the highest temperature reading of the two thermistors.
- Average: Use the average of the readings from the two thermistors.

Max Rack Temp

Highest temperature reading from the unit remote sensors.

REM Sensors Set to Control

Number of sensors set to control.

Unit Remote Sensors Mode

When controlling at the unit level, selects the method of using the inlet-rack temperature readings from the control sensors to control fan speed. Options are:

- Maximum: Use the highest temperature reading of the sensors set to Control.
- Average: Use the average of the readings from the sensors set to Control and included in AVG.

Unit Remote Sensors Included in AVG

When Unit Remote Sensors Mode is *Average*, selects the number of sensors used to calculate the average temperature.

- If the number selected is smaller than the number of REM Sensors set to Control, only the highest readings are used for the calculation.

NOTE: Depending on the type of thermal management unit, included components, and control settings of your system, all of the options listed may not be available on your Vertiv™ Liebert® iCOM™ display.

8.2.2 Wired Remote Sensor—Sensor Property Options**Function**

Sets the function of the sensor when Unit Remote Sensors Mode is enabled.

- Disable: Sensor readings are ignored.
- Reference: Sensor readings are considered for Max Rack Temp, but are not used in maximum/average calculations.
- Control: Sensor readings are used in maximum/average calculations.

Left Lead Current Value

Current reading of the left sensor probe. The left probe is always a temperature reading.

Left Lead Offset

Correction (calibration) value added to the reading. Used in the event that the sensor reading is incorrect.

- May be a positive or negative value.

Name

Custom, descriptive name to assist in identifying the sensor's location/function in the facility, for example, the name of the rack on which it is installed. The name is limited to:

- Up to four alphanumeric characters in length
- Upper and lower case alpha characters
- The following special characters: & * / . + - : @ \

Right Lead Current Value

Current reading of the right sensor probe. May be a temperature or humidity reading, depending on the connected sensor.

Right Lead Offset

Correction (calibration) value added to the reading. Used in the event that the sensor reading is incorrect.

- May be a positive or negative value.

9 Administering Firmware, Settings and Security

9.1 Vertiv™ Liebert® iCOM™ Firmware Upgrades

NOTE: The Liebert® iCOM™ Service Tool (iST) is required to update control board firmware. Contact technical support at 1-800-222-5877 for information on control board updates.

9.1.1 Compatibility with Earlier Versions of Liebert® iCOM™

Versions of Liebert® iCOM™-control firmware PA2.05.31R are incompatible with earlier firmware versions PA1.XX.XXXSTD.

The firmware versions PA2.05.31R and later cannot communicate with earlier versions. The Vertiv™ Liebert® DSE, Vertiv™ Liebert® Mini-Mate3, and Vertiv™ Liebert® PDX/PCW will not operate with PA1.XX.XXXSTD installed.

Contact your Vertiv™ representative to upgrade firmware.

9.1.2 Updating Liebert® iCOM™ Display Firmware

The display firmware is updated by loading the file via USB port, and the update process typically takes from 30 seconds to 20 minutes. Cooling unit functions continue during a display firmware update.



1. Download and extract the display-firmware file to a USB drive.
2. Insert the USB drive into an open port on the back of the Liebert® iCOM™ display. On the touchscreen, an update screen displays.
3. Compare the existing version with the version to which you are updating to confirm that you are installing the correct firmware, then check the box next to *Update Firmware To*.
4. Depending on whether you want to restore the display to factory defaults or keep the current display settings:
 - Check the box next to Reboot with Factory Defaults to return the display to factory-default settings.
 - Leave unchecked to retain the current display settings.
5. Press start. The display firmware is updated within 30 seconds to 5 minutes.
6. Wait for the unit information to appear at the top of the screen, which confirms the process is complete and the display has re-established communication with the board, before removing the USB drive.

9.1.3 Updating Liebert® iCOM™ Control Board Firmware

The CONTROL BOARD UPGRADE panel shows the firmware version of the control board of the cooling unit. It also includes settings to use while performing the upgrade.

NOTE: Only personnel who have completed Vertiv training should perform a control-board update. The Liebert® iCOM™ Service Tool (iST) is required to update control-board firmware. Contact technical support at 1-800-222-5877 for information on control-board updates.

1. Save the Liebert® iCOM™ software to a USB flash drive formatted with a FAT32 file system.
 - Make sure that the file-name extension is all lower case, .xpb not .XBP.
 - Remove all other files with the .xpb extension from the flash drive.
2. At the Liebert® iCOM™ control:

- Touch , then  > *Backup & Security* > *Control Upgrade*.
The FIRMWARE UPGRADE panel opens.
 - Make sure the *Lock for Upgrade*, is selected.
 - Refer to [Control Board Firmware Upgrade Options](#) below, for the reset and retain options.
3. Plug the USB drive into Port 1 or Port 2 on the display, and touch *Upgrade*.
The control-board firmware is upgraded.
 4. Remove the USB flash drive after the board reboots.

Control Board Firmware Upgrade Options

Lock for Upgrade

When selected, the unit is locked for a firmware upgrade.

Reset to Default Configuration

When selected, the unit is reset to the factory-default configuration during the upgrade

Retain Network Configuration

When selected, the current network settings and options are retained while all other settings are reset to the factory-default configuration.

Unlocking the Control Board Before Upgrade

If changes are made to the settings after the control board is locked for firmware upgrade, use the following steps to unlock the board and execute the changes.



1. In the *Lock for Upgrade* field on the FIRMWARE UPGRADE PARAMETERS panel, select *Unlock*, then select *Yes*.
2. Touch *Save*. The changes are executed.

9.2 Backing Up, Importing, Exporting, and Restoring Display Settings

Vertiv™ Liebert® iCOM™ display settings may be saved to a local disk or USB drive. (Setpoint parameters cannot be exported, only Liebert® iCOM™ display settings.) Saved files may be imported to restore Liebert® iCOM™ if it is replaced or if a problem occurs and to transfer settings to another Liebert® iCOM™. Liebert® iCOM™ can also be returned to factory default settings.

- **Backup:** Saves a copy of the settings in a file named with the IP address of the display board. The saved settings include network settings, unit name, panel configuration and other details of the Liebert® iCOM™ display. Use a back-up file to restore the unit settings in the event of a failure.
- **Restore:** Copies settings from a back-up file to return Liebert® iCOM™ function to exactly what it was before the problem or failure. The settings may be restored from a file on the local disk or a USB drive. When restoring from a file on USB, make sure that you use the correct back-up file to restore settings, otherwise settings for the display may be incorrect.
- **Export:** Saves a copy of the Liebert® iCOM™ display settings for later import to another Liebert® iCOM™ for identical display settings on both systems.
- **Import:** Loads Liebert® iCOM™ display settings from a previously-exported file to an additional Liebert® iCOM™ system for identical settings, including panel customization and custom labels, on both.

9.2.1 To Back Up or Restore



1. Touch , then  > *Backup & Security* > *Display Backup/Restore*. The BACKUP & RESTORE panel opens.
2. Touch the *Action Type* drop-down, and select the action to perform, then touch the *Location* where the back-up/import file is located or will be saved.

NOTE: USB drives connected to Ports 1 or 2 on the Liebert® iCOM™ display are automatically detected and displayed as options for Location selection.

3. Touch the action button in the lower-right corner. A notification indicates that the back up, restore, import, or export is complete.
 - Remove the USB drive from the port if used.

9.2.2 Resetting Display Settings to Defaults

You can return the Liebert® iCOM™ display to factory default settings, including panel customization, display network settings, and custom labels. Reset does not affect control board network settings, setpoints, or alarm thresholds.



1. Touch , then  > *Backup & Security* > *Backup and Restore*. The BACKUP & RESTORE panel opens.
2. Touch the *Reset to Defaults* button in the lower-right corner, then *Continue* on the confirmation dialog.

Use *Cancel* if you need to disregard the reset.

The display restarts, and the start up wizard opens to assist in configuring the reset display.

9.3 Backing Up and Restoring Control Board Settings

Vertiv™ Liebert® iCOM™ settings may be saved to a local disk or USB drive, and the saved files may be imported to restore Liebert® iCOM™ if it is replaced or if a problem occurs and to transfer settings to another Liebert® iCOM™.

1. Touch , then  > *Backup & Security* > *Control Backup/Restore*.
The BACKUP & RESTORE panel opens.
2. Touch the *Action Type* drop-down, and select the action to perform.
3. Select the location, site, and system to save back-up files or load restore/replicate files, see [Control Board Back Up and Restore Options](#) below, for descriptions.

NOTE: USB drives connected to Ports 1 or 2 on the Liebert® iCOM™ display are automatically detected and displayed as options for Location selection.

4. Touch the action button in the lower-right corner. A notification indicates that the back up, restore, or replicate is process complete.
5. Remove the USB drive from the port.

9.3.1 Control Board Back Up and Restore Options

Action Type

Selects the back up or restore function. Options are:

- Back up: Saves a copy of the settings in a file named with the IP address of the Liebert® iCOM™ control board. Use a back up file to restore the unit settings in the event of a failure.
- Replicate: Loads only the *configsafe* files (general settings/setpoints) from a backup file from another system.
- Restore: Loads a back up configuration from a previously saved backup file. For example, when a control board fails and must be replaced, you can load the configuration from a backup of the failed board.

Location

Indicates the port to which the USB drive is connected.

Site

Indicates the folder you created on the USB drive to which the back up system file is saved.

System

The back up file named with the IP address of the control board from which it was saved.

9.4 Managing Access Permission and Passwords

NOTICE

Risk of losing access to Vertiv™ Liebert® iCOM™. Can cause operational problems.



When a password is changed, make sure you record the new password and inform authorized users. If problems arise, passwords can be reset by Vertiv™ Technical Support, visit <https://www.Vertiv.com/en-us/support/>.

Two four-digit passwords provide two levels of permission to access Liebert® iCOM™ menus and are set with factory-default values. You can change the value of each password so that only those provided with the current password may access the menus that it unlocks.

The factory-default password for user and service login are:

- Default User password = 1490
- Default Service password = 5010



NOTE: To change the password, you must use the Service password currently-assigned to unlock the Service menu.

1. Touch , then  > *Backup & Security* > *Manage Permissions*.
The MANAGE PINS panel opens.
2. Touch the role to change, then touch the *Value* field for the password to change.
The keypad opens.
3. Type a new four-digit/character password, then touch , and touch *Save*.
The password is saved. Touch *Cancel* to discard the change.

9.5 Configuring with the Start Up Wizard

Upon initial use of the Vertiv™ Liebert® iCOM™ display or after resetting to defaults, the Liebert® iCOM™ start up wizard offers to guide you through first-time set up.

9.5.1 To Update System Information Using the Wizard

1. Touch , then  > *Backup & Security* > *Display Backup/Restore*, then touch *Reset to Defaults*. The display reboots.
2. On the WELCOME panel, touch *Next*. The DATE & TIME panel opens.
3. Touch each field to make your selections, then touch *Next*. The UNIT DISPLAY panel opens.
4. Touch each field to make your selections, then touch *Next*. The NETWORK panel opens.
5. Determine the use of network communications and configure as needed, then touch *Next*. The SUMMARY panel opens.
6. Review the selections and settings and, if correct, touch *Finish*.
 - If corrections are needed, touch *Previous* to return to the appropriate panels.

Start Up Wizard Options

Calibrate Screen

Optimizes touch response. See [Calibrating the Touchscreen](#) on page 8.

Language

Selects the display language.

Import

Imports previously saved display settings. See [Backing Up, Importing, Exporting, and Restoring Display Settings](#) on page 79.

Next

Continues configuration using the set up wizard.

Skip

Closes the start-up wizard and uses the factory-default settings.

10 Performing Diagnostics

NOTE: Depending on the type of thermal management unit, included components, and control settings of your system, all of the options listed may not be available on your Vertiv™ Liebert® iCOM™ display.

10.1 Cooling Unit Status LED

Just below the Liebert® iCOM™ touchscreen display is an LED that changes color and flashes on and off to indicate cooling unit status. See **Table 10.1** below, for the LED colors and meanings.

Table 10.1 Cooling Unit LED Colors and State Meanings

State	Color(s)	Meaning
Solid	Green	Powered on and operating.
Solid	Amber	In diagnostic/service mode or powered off.
Solid	Red	Active warning or alarm present and acknowledged.
Flashing	Amber/Green	In sleep or U2U standby mode and available to operate.
Flashing	Red/Green	Operating with an active warning or alarm.
Flashing	Amber/Red	Shut down (not operating) because of an unacknowledged alarm.
Flashing	Red	Active warning or alarm present but un-acknowledged.
Flashing	Blue	Liebert® iCOM™ display is starting up or updating Liebert® iCOM™ firmware.

10.2 Enabling Manual Mode for Diagnostics

Use manual mode to test components, validate operation, and evaluate performance.

NOTE: When manual mode is enabled, the cooling unit does not operate normally:



Fan operation depends on the diagnostic category in use.

Safety routines will prevent the use of some diagnostic features.



Active alarms may prevent some the use of some diagnostic functions.

In most cases, all components are turned off.



NOTE: When manual mode is disabled, all components and the cooling unit return to normal operation. See [Disabling Diagnostics Manual Mode](#) on the next page. Manual mode will time out after 30 minutes of inactivity and normal operation resumes.

1. Touch , then  > *Diagnostic/Service* > *Diagnostics* > *Manual Mode* in the Category list. The MANUAL MODE panel displays.
2. Touch the *Enable* check box in the upper-right of the *MANUAL MODE* panel. The *MANUAL MODE* confirmation dialog opens.
3. Touch *OK* to enable manual mode. Enable is checked and manual control for diagnostics enabled.
 - Touch *Cancel* to close the dialog and manual mode remains disabled.

10.2.1 Disabling Diagnostics Manual Mode

1. Touch , then  > *Diagnostic/Service* > *Diagnostics* > *Manual Mode* in the Category list. The MANUAL MODE panel displays.
2. Remove the check mark from the *Enable* box by touching it. Manual mode is disabled.

10.3 Diagnosing Evaporator Fan Issues

1. Touch , then  > *Diagnostic/Service* > *Diagnostics* > *Evaporator Fan* in the Category list. The EVAPORATOR FAN panel displays.
2. Refer to [Diagnostics—Evaporator Fan Options](#) below, for descriptions of diagnostic options.

NOTE: Depending on the type of thermal management unit, included components, and control settings of your system, all of the options listed may not be available on your Vertiv™ Liebert® iCOM™ display.

10.3.1 Diagnostics—Evaporator Fan Options

Analog Output 1

0V to 10V analog output that drives the speed of the evaporator fan. Typically, the evaporator fan is Analog Output 1 by default.

Analog Output 1 Selection

Var SpeedDrive.

Fan Speed

Current speed of fan.

Motors

Enables/disables fan motor during manual/diagnostic mode.

Status Airflow

Indicates if the status of the air safety switch is open or closed.



Status Filter

Status of the air filter.

Status Remote Shutdown

Indicates whether remote shutdown is on or off.

10.4 Diagnosing Compressor Circuit Issues

1. Touch , then  > *Diagnostic/Service* > *Diagnostics* > *Compressor Circuit N* (where “N” is the circuit number) in the Category list. The COMPRESSOR CIRCUIT panel displays.
2. Refer to [Diagnostics—Compressor Circuit Options](#) below, for descriptions of diagnostic options.

NOTE: Depending on the type of thermal-management unit, included components, and control settings of your system, all of the options listed may not be available on your Vertiv™ Liebert® iCOM™ display.

10.4.1 Diagnostics—Compressor Circuit Options

Compressor Capacity

Enables/disables compressor capacity during manual/diagnostics mode.

Compressor Cycle Ramp

Capacity at which compressor runs in manual mode.

Compressor Freeze Protection

Indicates whether freeze-protection influences compressor capacity (On) or not (Off), based on low-pressure values.

Compressor Mode

Selects compressor operation during manual/diagnostics mode. Options are:

- 0: Run (normal operation)
- 2: Charge

Compressor Overload

Compress overload status. Not applicable to Vertiv™ Liebert®Mini-Mate.

Compressor State

Compressor status, On or Off.

Fan Freeze Protection

Indicates whether freeze protection influences fan speed (On) or not (Off), based on low-pressure values.

High Pressure Alarm Code

Code of high-pressure alarm. To address the alarm condition, see [Resetting High Pressure Alarm Code](#) on the next page.

- 0: Okay
- Non-zero: High head pressure situation.

High Pressure Status

Status of compressor's high pressure switch.

High Temperature Alarm Counter

Number of high temperature alarm events. To address the alarm condition, see [Resetting High Temperature Alarm Counter](#) on the facing page

Low Pressure Alarm Code

Code of low-pressure alarm. To address the alarm condition, see [Resetting Low Pressure Alarm Code](#) on the facing page.

- 0: Okay.
- Non-zero: Low suction pressure condition.

Low Pressure Status

Status of compressor's low pressure switch.

Status HT1

Count of times compressor is powered-off for high scroll temperature.



Suction Pressure

Current pressure of the compressor suction.

10.4.2 Resetting High Pressure Alarm Code

When a high pressure problem has caused a compressor to lock off, resetting the High Pressure Alarm Code to zero unlocks the compressor for operation.

NOTE: Cycling main power of the cooling unit will also unlock the compressor.

1. Touch  , then  > *Diagnostic/Service* > *Diagnostics* > *Compressor Circuit N* in the Category list (where "N" is the circuit number).
2. On the COMPRESSOR CIRCUIT panel, touch *Set to Zero* next to High Pressure Alarm Code, then touch *Save*. The code is reset and the compressor can now operate.



10.4.3 Resetting Low Pressure Alarm Code

When a low pressure problem has caused a compressor to lock off, resetting the Low Pressure Alarm Code to zero unlocks the compressor for operation.



NOTE: Cycling main power of the cooling unit will also unlock the compressor.

1. On the Service menu, touch *Diagnostic/Service* > *Diagnostics*.
The DIAGNOSTICS panel opens.
2. Touch *Compressor Circuit N* in the Category list (where “N” is the circuit number).
3. On the COMPRESSOR CIRCUIT panel, touch *Set to Zero* next to Low Pressure Alarm Code, then touch *Save*. The code is reset and the compressor can now operate.

10.4.4 Resetting High Temperature Alarm Counter

1. Touch , then  > *Diagnostic/Service* > *Diagnostics* > *Compressor Circuit N* in the Category list (where “N” is the circuit number).
2. On the COMPRESSOR CIRCUIT panel, touch *Set to Zero* next to High Temperature Alarm Counter, then touch *Save*. The code is reset and the compressor can now operate.

10.5 Diagnosing Reheat Issues

1. Touch , then  > *Diagnostic/Service* > *Diagnostics* > *Reheat* in the Category list. The REHEAT panel displays.
2. Refer to [Diagnostics—Reheat Options](#) below, for descriptions of diagnostic options.

NOTE: Depending on the type of thermal management unit, included components, and control settings of your system, all of the options listed may not be available on your Vertiv™ Liebert® iCOM™ display.

10.5.1 Diagnostics—Reheat Options



Analog Output 1 – 4

0V to 10V analog outputs that operate reheat.

Electric Heat N

Enables/disables heaters in manual/diagnostic mode (where N = electric heat number).

10.6 Diagnosing Humidifier Issues

1. Touch , then  > *Diagnostic/Service* > *Diagnostics* > *Humidifier* in the Category list. The HUMIDIFIER panel displays.
2. Refer to [Diagnostics—Humidifier Options](#) below, for descriptions of diagnostic options.

NOTE: Depending on the type of thermal management unit, included components, and control settings of your system, all of the options listed may not be available on your Liebert® iCOM™ display.

10.6.1 Diagnostics—Humidifier Options

Humidifier

Enables/disables humidification in manual/diagnostic mode.

Humidifier Drain

Enables/disables humidifier drain. Does not apply to Vertiv™ Liebert® Mini-Mate3.



Local Hum PI

Current humidity PI percentage. Does not apply to Vertiv™ Liebert® Mini-Mate3.

Status Humidifier Problem

Current status of the humidifier. OK indicates that the status is good.

10.7 Diagnosing Digital Output Issues

1. Touch , then  > *Diagnostic/Service* > *Diagnostics* > *Digital Outputs* in the Category list. The DIGITAL OUTPUTS panel displays.
2. Refer to [Diagnostics—Digital Output Options](#) below for descriptions of diagnostic options.

NOTE: Depending on the type of thermal management unit, included components, and control settings of your system, all of the options listed may not be available on your Vertiv™ Liebert® iCOM™ display.

10.7.1 Diagnostics—Digital Output Options

Alarm Relay

Enables/disables alarms during manual/diagnostic mode.



K11 Relay

Enables/disables warnings during manual/diagnostic mode.

Q15 Output State

Enables/disables Q15 output during manual/diagnostic mode.

10.8 Diagnosing Analog Output Issues

1. Touch , then  > *Diagnostic/Service* > *Diagnostics* > *Analog Outputs* in the Category list. The ANALOG OUTPUTS panel displays.
2. Refer to [Diagnostics—Analog Output Options](#) below, for descriptions of diagnostic options.



NOTE: Depending on the type of thermal management unit, included components, and control settings of your system, all of the options listed may not be available on your Liebert® iCOM™ display.

10.8.1 Diagnostics—Analog Output Options

Analog Output N

Controls analog outputs during manual/diagnostic mode. (*Where N is the analog output number.*)

10.9 Diagnosing Customer Input Issues

1. Touch , then  > *Diagnostic/Service* > *Diagnostics* > *Customer Inputs* in the Category list. The CUSTOMER INPUTS panel displays.
2. Refer to [Diagnostics—Customer Input Options](#) below, for descriptions of diagnostic options.

NOTE: Depending on the type of thermal management unit, included components, and control settings of your system, all of the options listed may not be available on your Vertiv™ Liebert® iCOM™ display.

10.9.1 Diagnostics—Customer Input Options



Input N

Status and description of customer-input sensors. (Where N is the input number.)

11 Customizing Your Vertiv™ Liebert® iCOM™ Display

11.1 Setting General Display Properties

NOTE: You must be logged-in to adjust the settings. See [Powering On the Vertiv™ Liebert® iCOM™ and Logging In/Unlocking Controls](#) on page 6.

1. Touch , then  > *Display Options* > *Display Properties*.
The DISPLAY PROPERTIES panel opens.
2. Touch a value to select the setting from the drop-down list
3. Touch *Save* to save the property settings.
 - Touch *Cancel* to discard changes.

11.1.1 Unit Display Options

Alarm Buzzer Pattern

Selects or disables the audible alarm notification. See .

Allow System On/Off

Enables/disables powering on/off the entire system of networked units from the Liebert® iCOM™ display.

Backlight Brightness

Selects the brightness of the display back light.

Inactivity Timer

Time to elapse before display locks and dims.

Language

Selects the display language.

LED Brightness

Percentage brightness of the display.

Measurement System

Selects the units of measurement. Options are:

- Imperial (°F)
- Metric (°C)

Skin

Selects the background color format of the user interface. Options are:

- Dark Blue
- White
- Dark Grey

Touch Beep

Enable/disable sound when display is touched.

Touch Shockwave

Enable/Disable visual shockwave when display is touched.

Turn Unit On/Off without Password

When enabled, a Power On/Off button displays in the upper-right corner of the Vertiv™ Liebert® iCOM™ main display so personnel can turn the unit on or off with out logging-in and accessing the User/Service menus.



11.2 Customizing Main Display Views

The default Liebert® iCOM™ display view is essentially a layout of two panels, one with status content and the other with alarms content. You can create custom display views by adding, changing, moving, and resizing the content objects.

NOTE: You must be logged-in to customize the view. See [Powering On the Vertiv™ Liebert® iCOM™ and Logging In/Unlocking Controls](#) on page 6.

11.2.1 Moving Content

You can drag and drop content objects anywhere you like on the main display.

1. Touch , then .
2. Touch  in the upper right corner of the display and just below the control header.
3. Touch an object to select it (highlighted green), and drag it to the new location.

11.2.2 Resizing Content

You can resize content objects on the main display.



1. Touch , then .
2. Touch  in the upper right corner of the display and just below the control header.
3. Touch an object to select it (highlighted green), touch and drag a handle to re-size the object, see [Figure 11.1](#) on the facing page.

Figure 11.1 Add/Remove Content Icons and Resizing Handles



Item	Description
1	Content-adjustment icon
2	Resizing handles
3	Remove-content icon

11.2.3 Adding and Adjusting Content

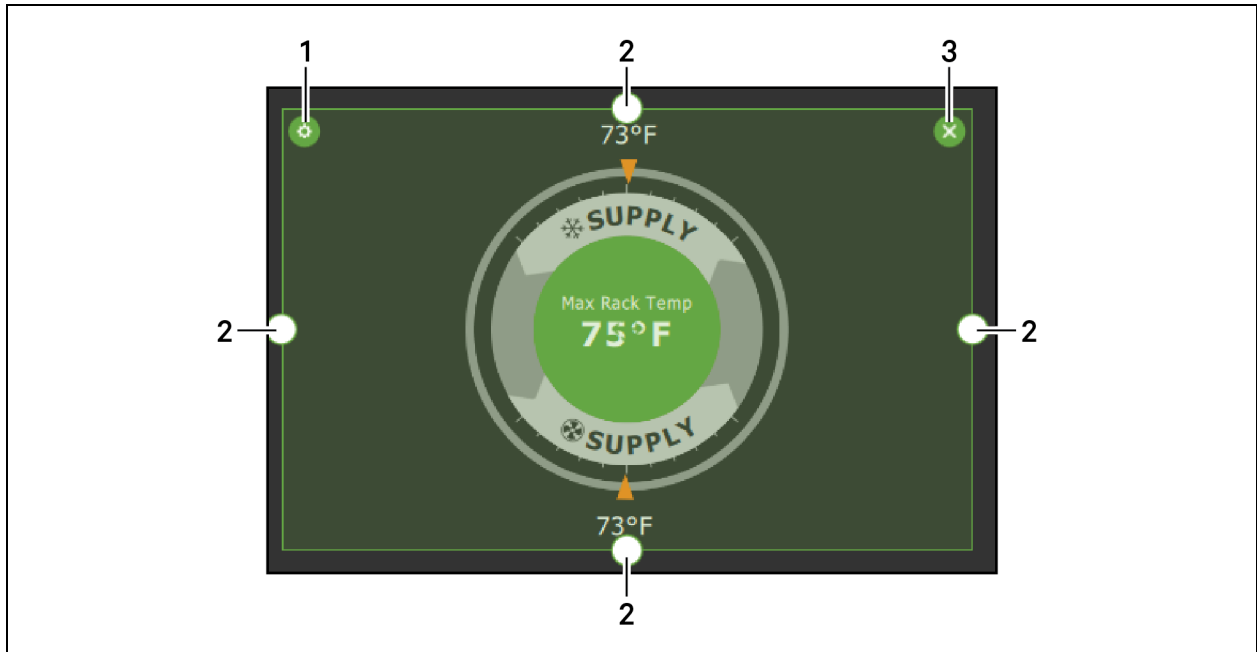
You can add a variety of content to the main display.









1. Touch , then .
2. Touch  in the upper-right corner of the display and just below the control header, then touch . A menu of content options opens, described in **Table 11.1** on the next page.
3. Touch the Move icon next to the content and drag it onto the display, then use the re-size handles to adjust as needed.
4. To adjust the content object or the way it displays, touch , see **Figure 11.1** above.

Table 11.1 Main/User Display Content Options

Content	Description
Separator	Separating line to place between content sections. You can adjust the thickness and orientation of the separator.
Dial	Status dial. You can select the sensor readings displayed in the center of the status dial when you touch to scroll through the readings.
Setpoint Readout	Displays the current reading of a connected sensor, for example: Return temperature at 72°F.
Setpoint Bar	Displays a bar graph for a selected setpoint with customizable empty and full limits. For example, if a temperature setpoint bar is empty at 60°F and full at 80°F, and the reading is 70°, the graph will be filled half way.
Sensor Bar	For remote sensors only, functions the same as the setpoint bar, but only offers connected remote sensors, and displays the customer-assigned name of the sensor next to the graph.
Shortcut	Shortcut opens panels directly instead of browsing through menus. You can select the destination of the shortcut, whether or not an icon displays, and the size, label, and frame of the shortcut.
Alarms	Alarms panel. You can select whether or not the information may be exported.
Event Log	Event-log panel. You can select whether or not the information may be exported.
Run Hours	Run-hours panel. Summary of the component run hours and limits.
EconoPhase Diagram	EconoPhase operating diagram.
EconoPhase Status	Compressor/EconoPhase status bar. Indicates the operating mode and the percentage at which the component is operating.

11.2.4 Removing Content



You can easily remove content from the main display.

1. Touch , then .
2. Touch  in the upper right corner of the display and just below the control header.
3. Touch an object to select it (highlighted green), then touch , see **Figure 11.1** on the previous page.

11.3 Customizing Parameter and Field Labels

You can customize header labels for parameters in the menus and you can customize field names.

NOTE: You can export labels for back-up or to use a text editor to customize the labels. See [Exporting, Importing, and Customizing Labels Using a Text Editor](#) on page 96.

1. Before going to the customization panel, use the search box and onscreen keyboard to find the label(s) that you want to customize. Once you know where they are, you'll be able to find them in the categories on the Customize Labels panel.
2. Touch , then  > *Display Options* > *Custom Labels*.
The CUSTOM LABELS panel opens. The labels are divided into “categories” that represent the names of menus, sub-menus and screen panels.

3. Locate the category that contains the label(s) to customize that you determined in step 1, and touch to expand it.



4. In the Custom Text column, touch the text box to edit, make changes and touch **Save** on the previous page, for an example of changing the column names for Property and Value (in the Analog Inputs panel) to Input and Configuration.
 - Touch *Cancel* to discard the change.
5. When finished editing labels, make sure the Enable Custom Labels is selected (or your updates will not display), and touch **Save**.
The label(s) are updated. **Figure 11.2** below, shows the Analog Input Properties panel with the custom labels that replaced Property and Value.

Figure 11.2 Custom Text for the Analog Input Properties Labels

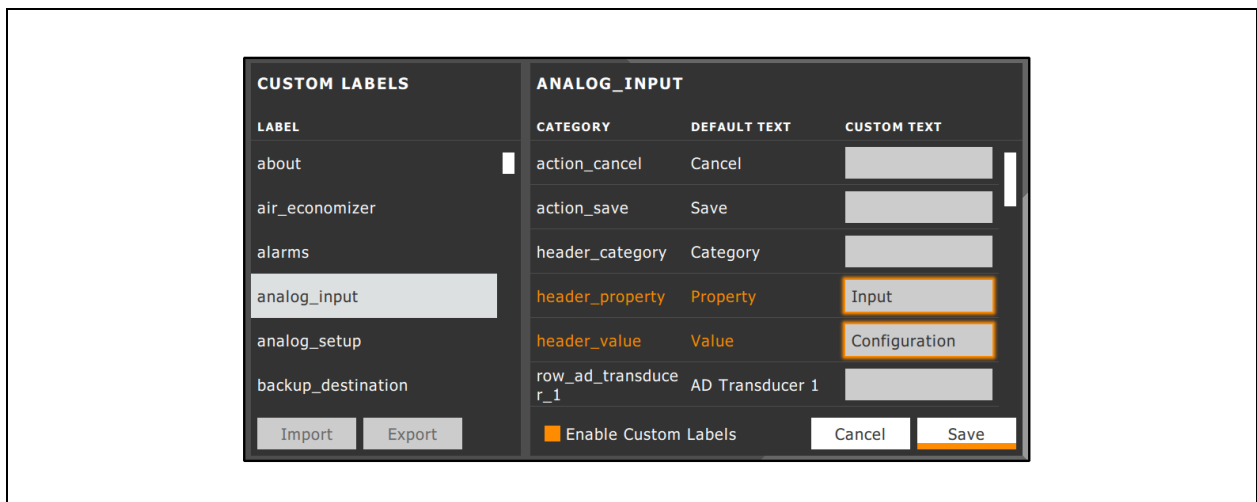
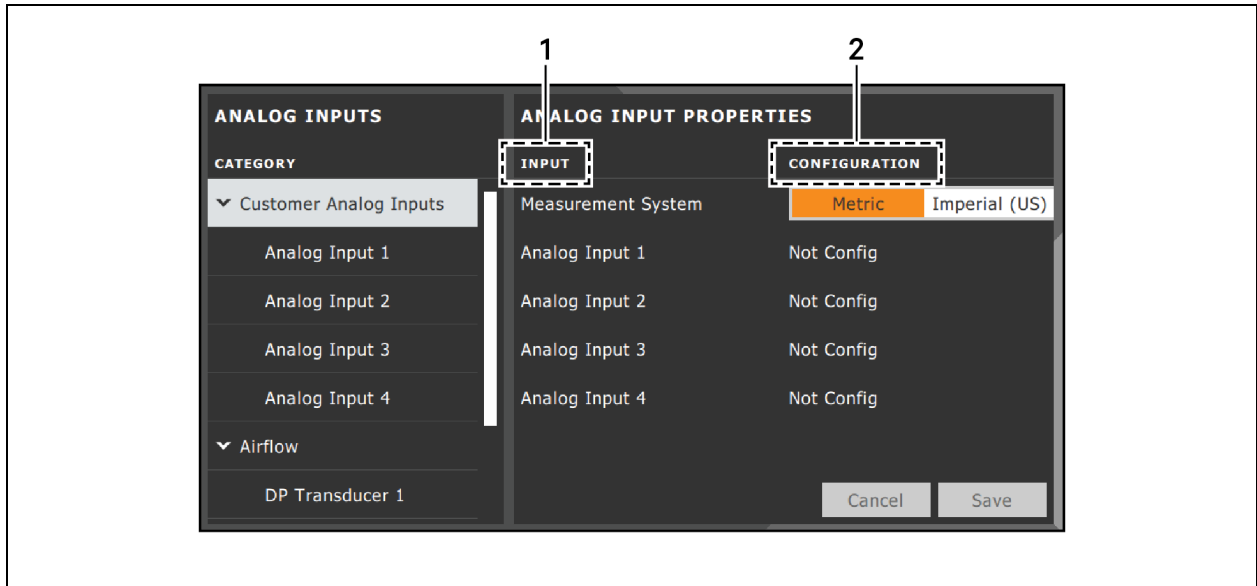

Figure 11.3 Customized Label Text on Analog Input Properties Panel



Item	Description
1	Former Parameter heading is now Input.
2	Former Value heading is now Configuration.

11.3.1 Exporting, Importing, and Customizing Labels Using a Text Editor

You can export custom label settings to a text file for back up or to modify the labels using a text editor. The text file is exported and imported using a USB drive.

1. Insert a USB drive into an open USB port on the rear of the touchscreen display, then navigate to the Custom Labels panel and touch *Export*.
The EXPORT FILE dialog opens, and the connected USB drive is automatically detected.
 - If you are prompted No USB devices are available, check the connection or try reinserting the drive.
2. Touch *Name* and type a descriptive name for the file, then touch *Go*.
3. Touch *Export* and wait at least 15 seconds, then you can remove the USB drive.
4. Insert the USB drive into a PC or laptop and locate the file, which is named with the Name you entered and the extension *.cl.txt*. For example, if you named your export *MyLabels*, the file will be *MyLabels.cl.txt*.
5. Open the file in a text editor.
The file contains all of the labels available for customization listed with the menu/panel on which the label is located, the label identifier, and an equal sign (=) as shown in the following example:

NOTE: You must use an editor that interprets Linux line endings, otherwise all of the lines will run together. For example, Microsoft WordPad will interpret the Linux line endings but Microsoft Notepad will not.

```
analog_input/row_customer_analog_inputs=Unit A Inputs
analog_input_properties/header_property=Property
analog_input_properties/header_value=Value
```

- To customize, type a new label name to the right of =, and save the text file.
The following example will result in the same custom labels shown in **Figure 11.3** on the previous page.

```
analog_input/row_customer_analog_inputs=Unit A Inputs
```

```
analog_input_properties/header_property=Input
```

```
analog_input_properties/header_value=Configuration
```

- Remove the USB drive with the updated/saved text file from the PC/laptop, insert it into an open USB port on the rear of the touchscreen display, then navigate to the Custom Labels panel and touch *Import*.
- Locate the updated text file in the drop-down list, and touch *Import*.
The dialog closes and the customizations display on the menus and panels that you updated.

This page intentionally left blank

12 Vertiv™ Liebert® iCOM™ Hardware Installation

Your unit includes the Liebert® iCOM™ controller. This section describes the installation of connections and cabling to fully utilize the Liebert® iCOM™ features.

12.1 Return Air Temperature/Humidity Sensor

The return temperature/humidity sensor is located in the unit return air section and is supplied on all Liebert systems with Liebert® iCOM™ controls. The assembly connects to plug connection P67 on the Liebert® iCOM™ internal control board on all Vertiv™ Liebert® DS, Vertiv™ Liebert® CW, Vertiv™ Liebert® DSE systems and plug P451 located on EEV #1 control board on the Vertiv™ Liebert® PDX unit.

Troubleshooting is accomplished by observing a green LED located on the sensor internal control board. If the LED is solid-green, the sensor is communicating properly with the Liebert® iCOM™ controller. If the LED is continuously flashing green, the sensor is not communicating properly and the P3 CANbus termination should be verified that it is properly terminated. No LED indicates the sensor does not have power present.

Figure 12.1 Temperature/Humidity Sensor Internal Control Board

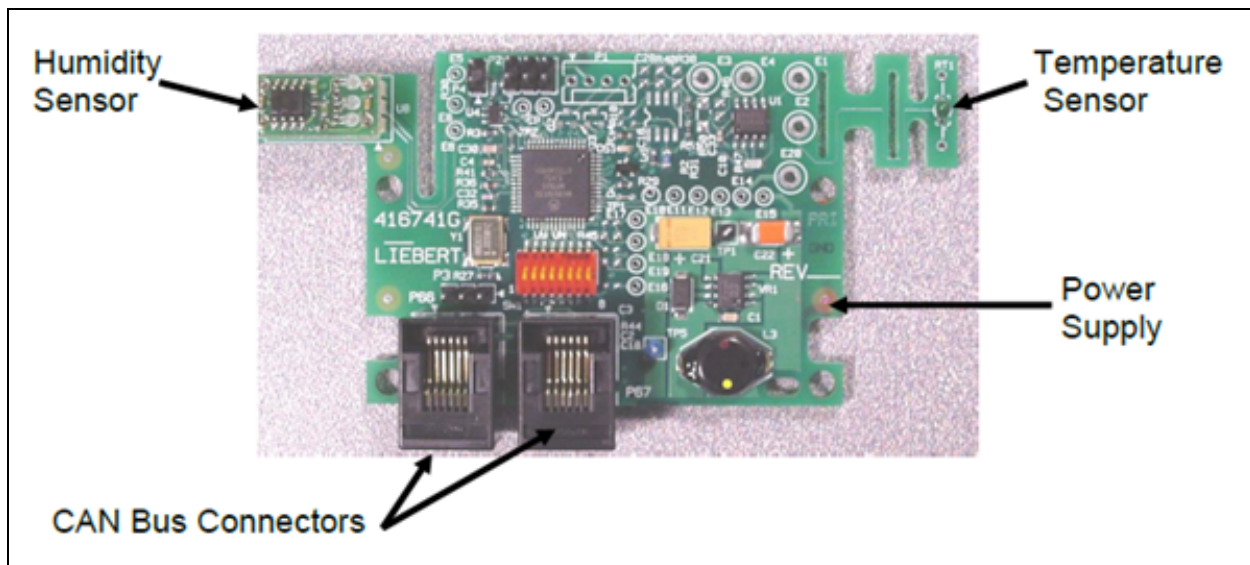

12.1.1 P67: Return Air Temperature—Humidity Board

P67-1: CAN communication

P67-6: CAN communication

Figure 12.2 Standard Return Air Sensor



Figure 12.3 Optional Remote Sensor A, B, C



Figure 12.4 Temperature/Humidity Sensor with Dip Switch/Jumper Settings

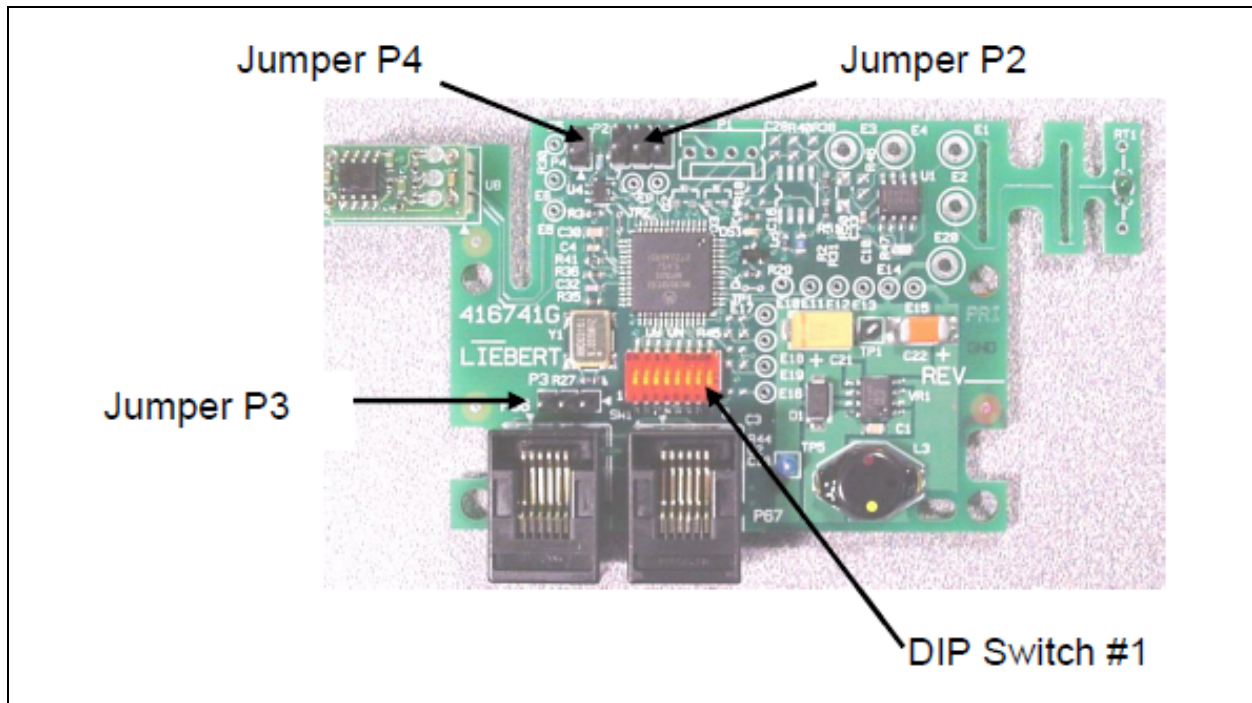

Table 12.1 Temperature/Humidity Sensor Dip Switch Settings

Sensor	Pos. #1	Pos. #2	Pos. #3	Pos. #4	Pos. #5	Pos. #6	Pos. #7	Pos. #8
Return T/H Sensor	Off	Off	Off	Off	On	Off	Off	Off
Optional Sensor A	On	Off	Off	Off	On	Off	Off	Off
Optional Sensor B	Off	On	Off	Off	On	Off	Off	Off
Optional Sensor C	On	On	Off	Off	On	Off	Off	Off

Table 12.2 Temperature/Humidity Sensor Jumper Settings

Jumper Label	Type	Position
P2	BDM Header	*Open
P3	CANbus Termination	*Shunt on Pins 2 and 3
P4	Programming	*Open
E10-E13	Serial Port	*Open

*Factory default positions and settings.

12.1.2 Jumper P3 CANbus Termination

The correct position of this jumper is dependent on your system configuration. If the sensor is physically the first or last node in the CANbus device loop, the jumper must be terminated or shunted across pins #2 and #3 (default position). If the sensor is a middle node in the CANbus device loop, the jumper must be unterminated or shunted across pins #1 and #2.

12.2 Installing a Fluid Temperature Sensor

1. Locate the DIP switches in the 2T sensor(s) by removing rear housing or via pre-cut hole in housing, **Figure 12.5** below, and program according to **Table 12.3** below.

Figure 12.6 on the facing page, shows the switch and on/off setting.

Table 12.3 DIP Switch Settings in 2T Sensors

	CANbus node ID	DIP-switch position							
		1	2	3	4	5	6	7	8
Fluid-circuit 1	30	Off	On	On	On	On	Off	Off	Off
Fluid-circuit 2	31	On	On	On	On	On	Off	Off	Off

Circuit 1 and 2 fluid sensors are dual-purpose CANbus IDs in firmware. These sensors might also be used for monitoring supply temperature. Before installing fluid temperature sensors, determine whether or not the supply-temperature 2T sensors are in use. Adding duplicate sensors will cause sensor communication loss.

Figure 12.5 Locating DIP Switches in 2T Sensor

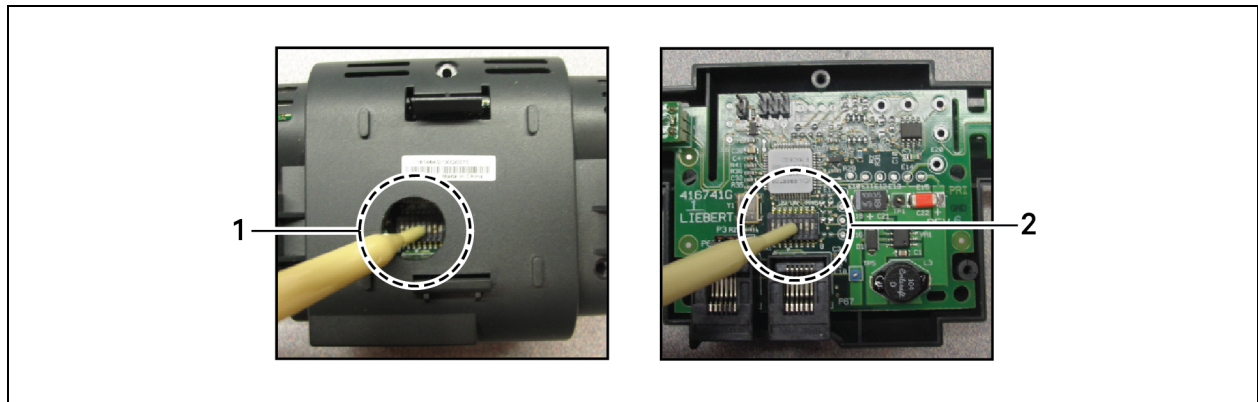

Item	Description
1	Hole in sensor housing
2	Cover removed

NOTE: Up is on, down is off on the DIP switch.

Figure 12.6 DIP Switches in 2T Sensor

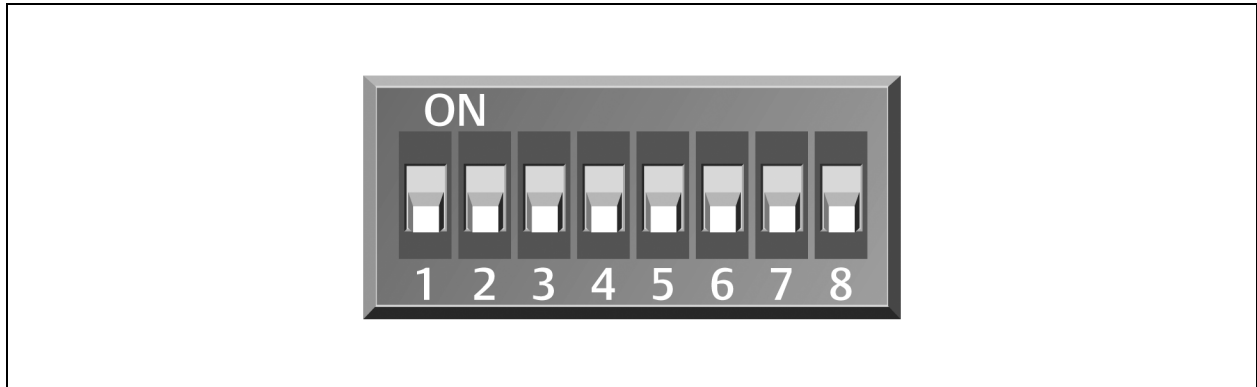

2. Once DIP switches are set, refer to , then continue with step 3 .
3. On Vertiv™ Liebert® iCOM™:
 - In the Service menu, touch *AuxiliaryDeviceSetup* > *Sensors* > *Fluid Sensors* > *Fluid 2T SensorCW T*. The SENSOR PROPERTIES panel opens.
 - In *Fluid Sensor Type*, select the type of 2T sensor.
4. At the fluid inlet and outlet, use a field supplied temperature sensor to verify the temperature readings, compare the Liebert® iCOM™ readings to the actual measured temperatures, and calibrate as needed.
 - If inlet and outlet temperature readings in Liebert® iCOM™ are reversed based on the field measurements, use Fluid Sensor 1/2 Placement to swap the readings.
5. Touch Save. The fluid temperature sensor settings are saved.

12.3 Installing Analog Input Devices

External sensors and analog devices may be connected to Liebert® iCOM™ using an electrical connection on the Liebert® iCOM™ control board to a required, factory-supplied plug, harness and terminal strip. (Contact Vertiv™ technical support for parts.)

When equipped, devices as follows can be connected to terminals 41, 42, 43 and 44, 45 and 46, or 47 and 48. **Table 12.4** below, lists available analog inputs depending on the type of cooling unit.

See [Configuring Analog Input Devices](#) on page 73 to configure the Liebert® iCOM™ settings for the device.

Table 12.4 Number of Analog Inputs Available by Cooling Unit Type

Cooling unit	Inputs available
Vertiv™Liebert® CW and Vertiv™Liebert® PCW with MBV	4 2 may be used for valve feedback on CW, 1 on Liebert® PCW.
Liebert® CW and Liebert® PCW with 3P (floating-point actuator)	4 2 may be used for valve feedback on CW, 1 on Liebert® PCW.
Liebert® DS and Liebert® DSE Air-cooled	2 Both used for low pressure transducers.
Liebert® DS Water/Glycol Cooling	0

Table 12.4 Number of Analog Inputs Available by Cooling Unit Type (continued)

Cooling unit	Inputs available
	Models without high pressure transducers may have 2.
Liebert® PDX Air-Cooled	3 1 is used for low pressure transducers.
Liebert® PDX Water/Glycol Cooled	2 1 is used for a low pressure transducer. Optionally, a second for a high-pressure transducer.

12.4 Installing the Unit to Unit (U2U) Network

12.4.1 Required Network Equipment

Ethernet cable CAT5 or greater.

- Maximum cable length is 328 ft (100 m).
- An Ethernet repeater is required for cable lengths greater than 328 ft (100 m).

Network switch

- IEEE 802.3; IEEE 802.3u
- 10/100 Mbps speed
- Multiple 10/100 RJ-45 ports, one shared.
- RJ-45 uplink port

NOTE: Up to 32 cooling units may be connected in a U2U network.

12.4.2 Planning Wiring Runs

When planning the layout of the conditioned space, consider the following:

- Good wiring practices.
- An Ethernet repeater is required for cable lengths greater than 328 ft. (100 m).
- A private network that only connects and manages the cooling units is required.
- Keep control and communication cables away from power cables to prevent electromagnetic interference.
- Keep cables away from noise introducing devuses such as machines, fluorescent lights, and electronics.
- Do not bend cables to less than four times the diameter of the diameter of the cable.
- Do not deform cables when hanging or securing in bundles.
- Do not exceed 25 lb. (11 kg) of tension when pulling cables to avoid stretching.
- Do not damage cables when securing them. Use only approve hangers, such as telephone wire/RG 6 coaxial-wire hangers.

12.4.3 U2U Wiring Connections

NOTICE

Cooling units are factory wired for stand alone operation. Do not connect the U2U network cabling before setting the U2U network configuration/groups. Network communication conflicts and unreliable display readings will result.

Before you begin, refer to [Preparing for U2U Group Set Up](#) on page 59 and [Configuring U2U Network Settings](#) on page 60.

– or –

Contact Vertiv™ Technical Support at 1-800-222-5877 or <https://www.Vertiv.com/en-us/support/>.

Table 12.5 Wall Mount Displays Drawings

Document Number	Title
DPN004840	Liebert® Mini-Mate Variable Capacity Unit-to-Unit Network Connections Two or More 3 Ton Units Networked Using Switch
DPN004841	Liebert® Mini-Mate Variable Capacity Unit-to-Unit Network Connections Two or More 4-5 Ton Units Networked Using Switch

U2U Network Requirements

The network must be private.

- Isolate from other network traffic.
- Switches connecting the units must be dedicated to Vertiv™ Liebert® iCOM™ communication only.
- Do not connect the U2U network to the building or IT network. If the U2U network experiences a failure, the cooling units continue to operate independently.

Vertiv™ Liebert® iCOM™ supports up to 64 nodes on the U2U network. The following are considered nodes:

- Input/output board (one in each cooling unit)
- Large wall mount display

Small touchscreen displays on the cooling unit are not considered nodes because they are directly connected to the input/output board in the unit, not the network.

Of the 64 nodes, up to 32 may be cooling unit input/output boards connected as a group. **Table 12.6** below, provides U2U network configuration examples.

Table 12.6 Example Liebert® iCOM™ U2U Network Configurations

Configuration Example	No. of Input/Output Boards (Cooling Units)	No. of Wall Mount Displays	Private Switch Required?
A	2	0	No
B	2	1	Yes
C	3	0	Yes
D	8	1	Yes
E	32	5	Yes
F	32	32	Yes

Appendices

Appendix A: Technical Support and Contacts

A.1 Technical Support/Service in the United States

Vertiv Group Corporation

24x7 dispatch of technicians for all products.

1-800-543-2378

Liebert® Thermal Management Products

1-800-543-2778

Liebert® Channel Products

1-800-222-5877

Liebert® AC and DC Power Products

1-800-543-2378

A.2 Locations

Vertiv Americas Headquarters

505 N. Cleveland Avenue

Westerville, OH 43082

Vertiv EMEA Headquarters

Victor-von-Bruns Strasse 21,

8212 Neuhausen am Rheinfall, Switzerland

Vertiv Asia Headquarters

Singapore Location

151 Lorong Chuan, Lobby D #05-04

New Tech Park, Singapore 556741

India Location

Vertiv Energy Private Limited

Plot No. C-20, Road No. 19

Wagle Industrial Estate, MIDC

Thane (West), Maharashtra 400604, India

China Location

Vertiv Technology Co., Limited

Floors 1–4 and 6–10,

Building B2, Nanshan I Park

No. 1001 Xueyuan Road, Nanshan District



Shenzhen, Guangdong 518055, China

Appendix B: Setpoints and Alarm Settings by Line ID

These tables list the parameters by the line identification assignments employed before the Vertiv™ Liebert® iCOM™ touchscreen. The tables include range/options of the parameter, the factory-default setting, and a description of the parameter function.

The line IDs are not listed in the User or Settings menus, only in the parameter directory. You can search the parameter list to find the line ID and its associated label and value in the Liebert® iCOM™ user interface.

To search the parameters list:

1. Log-in at the Service level, then touch  >  > Parameter Directory.
2. Enter a line ID or term in the Search field, and touch .

B.1 Line IDs for Setpoint Parameters

Table B.1 User Menu Setpoints by Line ID

Line ID	Parameter Name	Range	Default Setting	Description
U102	Temperature Setpoint Act	32 - 113°F 0.0 - 45.0 °C	73°F 23.0°C	Selects the temperature that the cooling unit will maintain by applying cooling and/or reheats. Temp Set value is the temperature that has been set by the User to control the temperature. Temp Act value is a read-only value that indicates if another routine, such as supply compensation, has internally modified the temperature controlling value. If compensation has not be activated, the ACT and SET values will always match.
	Temperature Setpoint	41 - 104°F 5.0 - 40.0°C	73°F 23.0°C	
	TempSetUsr	41 - 104°F 5.0 - 40.0°C	73°F 23.0°C	
U103	Temperature Control Sensor	Supply Sensor Remote Sensor Return Sensor	Return Sensor	Selects the sensor that will control the cooling capacity; either chilled water valve, compressors, free cooling valve, or air economizer. Unloading type compressors can be set to any type of sensor. However, fixed style compressors can only be set to Return or Remote sensors.
U104	Humidity Dew Point Setpoint	41 - 65°F 5.0 - 18.3°C	48°F 8.9°C	Selects a humidity level that the cooling unit will maintain by removing or adding moisture to the air. The humidity setpoint will be represented in %RH or dew point value depending on what the humidity control type is set for.
	Humidity Setpoint	20 - 80%RH	50%RH	
U105	Humidity Control Sensor	Remote Sensor Return Sensor	Return Sensor	Defines which humidity value the setpoint will be compared with. The return sensor is equipped with Temp/Humidity sensor and can calculate the dew point based on Liebert® iCOM™'s internal lookup table. If a sensor other than the return sensor is selected, the Liebert® iCOM™ will calculate the correct %RH based on the sensor selected and its actual temperature reading.
U106	Humidity Control Type	Relative Compensated Predictive Dew Point	Predictive	Selects the humidity control calculation. If set to Relative, the unit will control the humidity without considering any temperature deviations. If set to Predictive and Absolute, the control will consider the temperature deviation from temperature setpoint so that a constant level of moisture is kept in the area based on the humidity sensor reading and the temperature deviation from setpoint. Dew point allows the Liebert® iCOM™ controller to calculate the actual dew point of the space and to

Table B.1 User Menu Setpoints by Line ID (continued)

Line ID	Parameter Name	Range	Default Setting	Description
				control the humidity based on a user entered dew point temperature.
U107	Fan Setpoint	41 - 104°F 5.0 - 40.0°C	73°F 22.8°C	Required anytime the fan operates from a different sensor than that used for the temperature setpoint. For example, the temperature setpoint is set to Supply Air and the fan control is set to Remote Air. This is considered Optimized Aisle control, which decouples the fan and cooling capacity modulation. The remote sensor setpoint would modulate the fan speed and the supply sensor setpoint would modulate the cooling.
U108	Fan Control Sensor	Supply Sensor Remote Sensor Return Sensor Manual	Disabled	Determines which sensor will control the speed of the fan. If set to Manual, then the fan control can be set through the local Liebert® iCOM™ display or through the BMS system via one of the various Liebert® IntelliSlot™ monitoring cards.
U110	Optimized Aisle Enabled	Disabled Enabled	Disabled	This read-only value indicates if the Liebert® iCOM™ controller is setup in a Optimized Aisle configuration. To enable optimized aisle via the Liebert® iCOM™ display, the Supply Air sensor must be set to control the cooling capacity and the remote sensor must be set to control the fan speed. This allows the cooling unit to maintain rack temperatures while still maintaining an even under floor air temperature when controlling unbalanced rooms.
U113	2nd Temperature Setpoint	41 - 104°F 5.0 - 40.0°C	73°F 23.0°C	Allows for a dry contact through the customer input connections. When a customer input connection is set for 2nd temperature setpoint and that input is triggered, then the value set in this parameter sets the active temperature setpoint the unit will maintain. If the unit is configured for Decoupled mode, then this setpoint will only affect the temperature control setpoint; it will not affect the fan control setpoint.
U114	Supply Temp Limit Setpoint	41 - 81°F 5.0 - 27.0°C	41°F 5.0°C	Selects the minimum discharge air temperature. When the actual sensor reading approaches this parameter, the cooling capacity will be limited to avoid going below the Supply Limit Temperature value. This parameter must be enabled in the Service menu/Setpoints menu prior to setting a supply limit setpoint.
U116	BMS Backup Temp Setpoint	41 - 104°F 5.0 - 40.0°C	73°F 23.0°C	Selects a temperature setpoint that will be activated in the event of a BMS timeout or a customer input signal. The BMS timer and/or the customer input must be configured for this parameter to activate. If the unit is operating in Decoupled mode, then this setpoint will only affect the temperature control setpoint; it will not affect the fan control setpoint.
U117	BMS Backup Fan Setpoint	41 - 104°F 5.0 - 40.0°C	73°F 23.0°C	Selects a temperature setpoint when the backup fans will be activated in the event of a BMS timeout or a customer input signal. The BMS timer and/or customer input must be configured in order for this parameter to activate. If the unit is operating in Decoupled mode, then this setpoint will only affect the temperature control setpoint; it will not affect the fan control setpoint.
	BMS Backup Fan Speed	0 - 100%	100%	
U119	Return Compensation Setpoint	41 - 104°F 5.0 - 40.0°C	73°F 23.0 °C	Allows the return air sensor to be used even when in Supply or Remote temperature control mode. Return Compensation modifies the temperature setpoint to ensure that the return air temperature is kept above a specific temperature. If the return compensation value is set to 80 °F and the actual return temperature falls to 75 °F, then the controlling temperature setpoint will be increased and will reflect in the Control Temp Act parameter.

Table B.2 Service Menu Setpoints by Line ID

Line ID	Parameter Name	Range	Default Setting	Description
S102	Temperature Control Sensor	Supply Sensor Return Sensor Remote Sensor	Return Sensor	Selects which sensor will be controlling/influencing the cooling capacity. Cooling Capacity is either the Chilled Water Valve, Compressor, Free Cooling Valve, or Air Economizer. Unloading type compressors can be set to any sensor type, however fixed style compressors can only be set to Return or Remote control sensor.
S103	Temperature Setpoint	41 - 104°F 5.0 - 40.0°C	73°F 23.0°C	Selects a temperature that the cooling unit will maintain by applying cooling and/or reheats. The temperature setpoint value that has been set by the User to control the temperature.
	Temperature Setpoint Actual	32 - 113°F 0.0 - 45.0°C	73°F 23.0°C	The temperature setpoint actual value is a read-only value that indicates if another routine, such as supply compensation has internally modified the Temperature controlling value. If compensation has not been activated, the ACT and SET will always match.
S104	Temperature Control Type	Proportional PI Adaptive PID Intelligent	PI	Sets the type of control to be followed: Proportional, PI, Adaptive PID (auto-tuning), Intelligent
S105	Temperature User Low Limit	41 - 104°F 5.0 - 40.0°C	41°F 5.0 °C	Defines the temperature range below setpoint; temperature setpoint cannot be adjusted below this value. If the setpoint value has been adjusted lower than this setting, then the setpoint will automatically default back to its previous setting.
	Temperature User High Limit	41 - 104°F 5.0 - 40.0°C	104°F 40.0°C	Defines the temperature range above setpoint; temperature setpoint cannot be adjusted above this value. If the setpoint value has been set higher than this setting, then the setpoint will automatically default back to its previous setting.
S106	Temperature Proportional Band	4 - 200°F 2.2 - 111.0 K	12 °F 6.7 K	Adjusts the activation points of compressors/chilled water valves or rate of changed based on the actual sensor values deviation from setpoint. The smaller this number, the faster the compressors/chilled water values will increase capacity. Too small of a number may cause the unit to short cycle compressors or excessively reposition the valve.
	Temperature Integral Time	0.0 - 15.0 min	5.0 min	Adjusts the capacity of the units based on time away from setpoint so that accurate temperature control can be maintained. The proportional and integral time settings work together to maintain setpoint. Large p-band and small integral time is typical when controlling to supply air.
S107	Temperature Derivative Time	0 - 900 sec	0 sec	
S108	AutoSet Enable	No Yes	Yes	Sets the temperature and humidity proportional bands automatically based on the type of unit when this parameter is set to YES and if teamwork modes are selected. To change the proportional bands, this parameter must be set to NO. If supply or remote sensors are used, then this value is always set to NO.
S109	Temperature Deadband	0 - 36°F 0 - 20.0 K	2 °F 1.1 K	Avoids overshooting of the setpoint and cycling between cooling and reheats. The value entered in this field will be split in half by the temperature setpoint.
S110	Supply Limit Enabled	No Yes	No	Chilled water units may be set up with the supply air sensor to maintain a minimum air temperature under the raised floor to help prevent condensation. In order to avoid supply temperatures that are too low, the Supply Limit can influence the opening of three-point or analog actuators or the output of analog values. The control compares the deviation from the return air setpoint and the supply limit setpoint, and calculates the output to the actuator from the smaller deviation.
	Supply Limit Setpoint	41 - 81°F 5.0 - 27.0°C	41°F 5.0°C	
S111	Heater Deadband			Changes the amount of deviation below the temperature setpoint that the heaters

Table B.2 Service Menu Setpoints by Line ID (continued)

Line ID	Parameter Name	Range	Default Setting	Description
		0 - 36°F 0 - 20.0 K	0°F 0.0 K	will cycle ON and OFF. This value is added to the heating side of the normal temperature deadband.
S113	Enable Temperature Compensation	No Return Supply Ret+Sup	No	Temperature compensation allows for a second or even a third sensor to be used that will influence the units cooling or heating. Return compensation can be used when the supply or remote sensors are being used for control. Then the return sensor is then monitored to maintain a minimum return temperature. Supply compensation can be used only when Optimized Aisle (TW3) is enabled. The supply sensor will not only be used for controlling cooling capacity but will also monitor the cold aisle temperature to ensure that the cold aisle temperature setpoint is met.
S114	Return Compensation Setpoint	41 - 104°F 5.0 - 40.0°C	73°F 23.0°C	The temperature setpoint where compensation begins to operate by increasing the supply air setpoint.
S115	Return Compensation Band	0 - 18°F 0.0 - 10.0 K	0°F 0.0 K	The return compensation band/value will determine how quickly the cooling capacity is adjusted as the return temperature drops below the return compensation setpoint.
	Return Compensation Value	0 - 18°F 0.0 - 10.0 K	0°F 0.0 K	
S116	Supply Compensation Value	0 - 18°F 0.0 - 10.0 K	0°F 0.0 K	The Supply Compensation value determines how much the supply temperature setpoint will be reduced when the units fan speed is at 100% and the cold aisle is not able to maintain temperature setpoint. Any modifications to the supply temperature setpoint will be shown at the temperature setpoint on parameter S103 as the actual active control point.
S118	Compressor Capacity Filter at 0 %	0.01 - 99.99 %/s	0.60 %/s	Controls the rate of change during compressor load changes to avoid overshoots. The filter value depends on the current control deviation from setpoint. On the setpoints (at 0% call for cooling), it's typically set lower (slow).
	Compressor Capacity Filter at 100%	0.01 - 99.99 %/s	4.00 %/s	At the end of the proportional band (at 100% call for cooling) it's typically set higher (faster).
S119	Capacity Transition Filter	0.01 - 99.99 %/s	4.00 %/s	This parameter should only be adjusted by a factory service trained technician. The transition capacity filter controls how quickly the capacity changes between different modes of operation. This filter helps with the transition to avoid overshoot.
S120	CW Capacity Filter at 0%	0.01 - 99.99 %/s	0.10 %/s	The CW capacity filter controls the rate of change during a valve position adjustment to avoid overshoots. The filter value depends on the current control deviation from setpoint. On the setpoint (at 0% call for cooling), its typically set lower (slower)
S121	CW Capacity Filter at 100%	0.01 - 99.99 %/s	0.60 %/s	At the end of the p-band (at 100% call for cooling) its typically set higher (faster)
	BMS Backup Temp Setpoint	41 - 104°F 5.0 - 40.0°C	73°F 23.0°C	Selects a temperature setpoint that will be activated in the event of a BMS timeout. The BMS timer must be configured for this parameter to be active.
S122	2nd Temperature	41 - 104°F	73°F	Selects a temperature setpoint that will be activated in the event of a customer

Table B.2 Service Menu Setpoints by Line ID (continued)

Line ID	Parameter Name	Range	Default Setting	Description
	Setpoint	5.0 - 40.0°C	23.0°C	input signal configured as the second setpoint. The customer input must be configured for the parameter to activate.
S124	Humidity Control Sensor	Remote Sensor Return Sensor	Return Sensor	Defines which humidity sensor the humidity setpoint is compared with. The return sensor is equipped with a Temp/Hum sensor and can calculate the dew point based on Liebert® iCOM™'s internal lookup table. If a sensor other than the return sensor is selected, the Liebert® iCOM™ will calculate the corresponding RH% based on that sensors actual temperature.
S125	Dew Point Setpoint	41 - 65°F 5.0 - 18.3°C	48°F 8.9°C	Selects a humidity level that the cooling unit will maintain by removing or adding moisture to the air. The humidity setpoint will either be set in percent RH or as a dew point value depending on what the humidity control type is set for.
	Humidity Setpoint	20 - 80%	0.5	
S126	Humidity Control Type	Relative Compensated Predictive Dew Point	Predictive	Selects the humidity control calculation. Setting this parameter to Relative (%RH) will control the humidity without considering any temperature deviations. Predictive and Absolute control consider the temperature deviation from temperature setpoint so that a constant level of moisture is kept in the area based on the humidity sensor reading and the temperature deviation from setpoint. Compensated is recalculated with the actual deviation from temperature setpoint. 1° Celsius is equal to 3 % RH, indirect proportional. If temperature increases, the humidity setpoint is decreased and vice versa.
	Humidity Control Mode	Supply Return	Return	
S127	Dew Point Proportional Band	2 - 18°F 1.1 - 10.0 K	8°F 4.4 K	Adjusts the activation points of the humidifier and compressors based on the actual sensor values deviation from setpoint. The smaller this number, the faster the compressors and humidifier will increase capacity. Too small of a number may cause the unit to short cycle or overshoot setpoint.
	Humidity Proportional Band	1 - 20%	0.2	
S128	Humidity Integration Time	0.0 - 25.0 min	0.0 min	Adjusts the capacity of the unit based on a time away from setpoint so that accurate humidity control can be maintained. If the integration time is set to 0, the humidity control operates as a proportional only control. When integration time is set, the control mode changes to "PI" control
S129	Humidity Deadband	0 - 18°F 0.0 - 10.0 K	4°F 2.2 K	Prevents overshooting of the setpoint and cycling between humidification and dehumidification. The value entered in this field will be split in half by the temperature setpoint.
S130	Dehum Supply Temperature Setpoint	41 - 104°F 5.0 - 40.0°C	54 °F 12.2°C	Allows for a target temperature setpoint to be activated when a call for dehumidification is enabled instead of the traditional method of over cooling the space by increasing cooling to 100% and lowering fan speed if equipped. Must be in supply air control mode. When a call for dehumidification is active, the supply or remote sensor setpoint will be lowered to this parameter. This parameter should be set below the accepted dew point threshold of your space. Used only when supply dehumidification is enabled.
	Actual Dehum Temperature Setpoint	41 - 104°F 5.0 - 40.0°C	50°F 10.0 °C	
S131	Dehum Setpoint Adjustment	0 - 18°F 0.0 - 10.0 K	9°F 5.0 K	Sets the amount of that the Dehum Temp Setpoint is adjusted once the reheats activate. For example, if the unit is equipped with a reheat device, this parameter will increase the dehumidification temperature as the call for reheats are increased until the reheat call is at 100%. When the reheats are at 100%, the full Dehum Setpoint Adjustment will be applied.
	Dehum Setpoint Filter	0.01 - 0.10 K/s	0.02 K/s	

Table B.2 Service Menu Setpoints by Line ID (continued)

Line ID	Parameter Name	Range	Default Setting	Description
S132	Dehum Reheat/LL Sensor	Supply Sensor Remote Sensor Return Sensor	Return Sensor	Sets the sensor and temperature start point that the reheat will be deactivated and dehumidification will be stopped due to over cooling the space in a call for dehumidification.
	Dehum Reheat/LL Setpoint	41 - 104°F 5.0 - 40.0 °C	71°F 21.7°C	
S133	Dehum/Reheat Low Limit 1 Temp Hysteresis	-30.0°F - -2.0°F -16.7K - -1.1K	-5°F -2.5 K	Dehum/Reheat Low Limit 1
	Dehum/Reheat Low Limit 2 Temp Hysteresis	-30.0°F - -2.0°F -16.7K - -1.1K	-7 °F -3.9 K	Dehum/Reheat Low Limit 2
S13A	Dehum Reheat Proportional Band	2 - 54°F 2.0 - 30.0 K	14 °F 7.8 K	Sets the reheat proportional band for reheat operation independently of the temperature proportional band. This parameter can be used to activate the reheats at different points below the temperature setpoint.
S13B	Estimated Aisle Temp	41 - 104°F 5.0 - 40.0°C	75°F 23.9°C	Sets an estimated cold aisle temperature when humidity control sensor is set to remote and no remote temperature sensors are installed at the unit. This estimated temperature will be used to determine the humidity versus using an actual temperature in the cold aisle that may fluctuate during modes of dehumidification or load changes of the IT equipment. This provides a stable control point to reference the actual measured dew point from the return sensor.
S135	DT1 (Room/Outdoor) Type	0 = Disabled 1 = Contact 2 = EFC 3 = Temp 4 = Set	Temp	Sets the activation point of the ambient dry bulb outdoor temperature as it relates to either an indoor actual temperature or temperature setpoint.
S136	DT1 (Room/Outdoor) Value	2 - 72°F 1.0 - 40.0 K	5°F 3.0 K	Field adjustable setpoint or temperature.
S137	DT2 (Room/FC Fluid) Type	Disabled Contact Temp Set	Disabled	Determines the method to activate the water circuit on Dual Cool and Free Cool units. It may be set to CONTACT, TEMP or SET. CONTACT uses a dry contact to activate the free cooling circuit. TEMP uses a sensor reading that can be compared to the return temp to see whether free cooling is possible. SET compares the temperature set to the free cooling sensor to determine free cooling availability.
S138	DT2 (Room/FC Fluid) Value	0 - 36°F 0.0 - 20.0 K	12 °F 6.7K	Sets the delta T between the actual temperature and fluid temperature that must be met before free cooling will occur.
S139	Minimum Chilled Water Temp Enable	No Yes	Disabled	Enables the temperature at which free cooling can operate independently without assistance of the compressor circuit(s).
S140	Minimum Chilled Water Temp Value	32 - 68 °F 0.0 - 20.0°C	45°F 7.0°C	Sets the water temperature at which 100% free cooling can be provided to handle the full room load. When the fluid temperature is below this setting, then the compressors will no longer turn ON until the water temperature is above the minimum CW temperature.

Table B.2 Service Menu Setpoints by Line ID (continued)

Line ID	Parameter Name	Range	Default Setting	Description
S141	Lockout FC at Fluid Below	6 - 50°F -15.0 - +10.0°C	32°F 0.0°C	Prevents frost from building up on the free cooling pipes when the outdoor ambient temperature is extremely low by turning OFF the free cooling circuit when the water temperature is too low.
S146	Fan Control Sensor	Supply Sensor Remote Sensor Return Sensor Manual	Return Sensor	Controls the fan speed for modulation. If MANUAL is selected, then the fan speed can be controlled from the local display or through a building management system.
S147	Fan Setpoint	41 - 104°F 5.0 - 40.0°C	73°F 22.8°C	Activated when a temperature sensor is being used to control the fan speed. If the same sensor is used for temperature control and fan speed control, then this value will reflect the same setpoint as the temperature control setpoint. Manual mode uses fan speed STD for control.
S148	Fan Temperature Control Type	Proportional PI Adaptive PID	PI	Sets the type of control the unit will use to control fan speed. PI control gain is set in the Temp Prop/Integral parameter. PI control will operate the fan speed so that the actual temperature of the fan control sensor is equal to the fan temp setpoint. If PROPORTIONAL only is selected, the fan will change ONLY based on the deviation from setpoint which will allow the actual temp to settle higher than setpoint.
149	Fan Temperature Control Prop Band	4 - 200°F 2.0 - 111.0 K	36°F 20.0 K	Adjusts the fan speed rate of change based on the actual sensor values deviation from setpoint. The smaller this number, the faster the fans will increase speed. Too small of a number may cause the fans increase/decrease to overshoot setpoint.
	Fan Temperature Control Integration Time	0.0 - 15.0 min	1.0 min	Adjusts the fans of the unit based on time away from setpoint so that accurate temperature control can be maintained. The proportional and integral work together to maintain setpoint. Large p-band with small integral time is a typical way to achieve stable control.
S150	Fan CFF Hysteresis	0 - 20%	0.02	Modifies the reaction of the fan speed when fan speed is being dictated by the Call for Cooling. Adding the Hysteresis may result in a lagged response to changes in fan speed.
	Fan Deadband	0 - 36°F 0 - 20.0 K	1°F 0.6 K	Avoids overshooting of the setpoint. The value entered in this field will be split in half by the fan speed setpoint.
S151	Airflow Calibration	3.0 - 10.0 V	10.0 V	Allows the front display to be scaled to show the actual percentage of air flow independent of the voltage operating the fan speed. This value cannot be set above/below the Analog Output High/Low Limit for the fan set in the Advanced Menu. This also includes the service menu fan speed parameters.
S152	Fanspeed VSD Setpoint Minimum	0 - 100%	0.7	Sets the range for the variable fans. Min sets the minimum speed that the fan will operate at. Fan speed is modulated between MIN and STD based on which sensor is set as the controlling sensor, setpoint and the PI settings. If the controlling sensor is set to manual, then the STD setting will control the current fan speed. This parameter is also adjustable through the BMS.
	Fanspeed VSD Setpoint Standard	0 - 100%	1	
S153	Fanspeed VSD Setpoint Dehum	0 - 100%	70%	Sets the fan speed when a call for dehumidification is active. This allows the units fan speed to be ramped lower to help with any over cooling due to the dehumidification process. This also allows the coil to remove additional moisture even faster.
	Fanspeed VSD Setpoint No Power	0 - 100%	100%	

Table B.2 Service Menu Setpoints by Line ID (continued)

Line ID	Parameter Name	Range	Default Setting	Description
S154	Allow Fan Modulation on Compressors	No Yes	Yes	Provides the option to set the fan to fixed speed if unit is equipped with compressors. Once this parameter is set at the local display, it must be removed at the local display to re-engage fan speed control.
S155	High Return Limit Enable	Disabled Local Team	No	Sets a control point that will increase the fan speed if the return temperature exceeds the limit set in the High Return Temperature Limit parameter. If set to DISABLED, no limit will be applied to the return air temperature. If set to LOCAL, then only the local units return temperature will be monitored for applying the limit. If set to TEAM, then the highest networked unit return temperature will activate the limit on all connected units.
S15A	High Return Temperature Limit	41 - 104°F 5.0 - 40.0°C	85°F 29.4°C	Sets the temperature limit that will increase the fan speed to decrease the return temperature. Some compressors may require this limit to prevent extremely high temperatures that could potentially cause degradation of the compressor oil, that could decrease the overall compressor life expectancy.
S15B	Return Limit Proportional Band	0 - 36°F 0.2 - 20.0 K	20 °F 11.1 K	Sets the rate of fan speed increase as the actual return temperature approaches the limit set in the High Return Temperature limit parameter.
S157	Fan Startup Time	0 - 600 sec	3 sec	Determines the speed of the fan at system start up. The fan will operate at the set speed (%) until the set time has elapsed; at this point the fan will assume normal operation.
	Fan Startup Speed	0 - 100%	100%	
S158	Fan Speed Filter at 0%	0.01 - 99.99%/s	0.20 %/s	This parameter should only be adjusted by factory service trained technician. Fan Cap Filter at 0/100% controls the rate of change during fan speed changes to avoid overshoots. The filter value depends on the current control deviation from setpoint. On the setpoint (at 0%), its typically set lower (slower). At the end of the p-band (at 100%) its typically set higher (faster). The value is given as a % control output per second change. This parameter sets the rate of changed based on where actual temperature is when compared to setpoint.
S159	Fan Speed Filter at 100%	0.01 - 99.99 %/s	1.00 %/s	This parameter should only be adjusted by factory service trained technician. The transition fan speed filter controls how quickly the fan speed changes between different modes of operation. This filter helps with the transition to avoid overshoots.
	Fan Speed Transition Filter	0.50 - 99.99 %/s	1.00 %/s	
S160	Fan Speed Reposition Mode	Decel Both	Decel	This parameter should only be adjusted by factory service trained technician. The fan speed reposition mode/delay is a one time delay as the fan speed is requested to change direction. This delay will be applied only when the fan speed is commanded from an increasing to decreasing state or decreasing to increasing state. This allows the fan to hold its current position while the temperature stabilizes.
	Fan Speed Reposition Delay	0 - 300 sec	0 sec	
S161	Max Deceleration Rate	0.01 - 99.99 %/s	0.10 %/s	This parameter should only be adjusted by the factory service trained technician. Only slows the decreasing of the variable fan speed. The control will use the slower of this parameter and the fan speed filter.
S162	BMS Backup Fan Setpoint	41 - 104°F 5.0 - 40.0°C	73°F 23.0°C	Selects a fan speed setpoint that will be activated in the event of a BMS timeout. The BMS timer must be configured for this parameter to activate.
	BMS Backup Fan Speed	0 - 100%	1	
S163	BMS Backup Fan Operation	Disabled BMS Backup Spd	Disabled	Sets the default operation of the fan speed control when a BMS timeout occurs. Default is disabled which will keep the fan speed at the last value before the

Table B.2 Service Menu Setpoints by Line ID (continued)

Line ID	Parameter Name	Range	Default Setting	Description
		Coupled BMS Backup Set		disconnect occurred. STD speed will ramp the fan to the STD speed setting. This will drive the fan speed to its maximum speed. The control will use the slower value. COUPLED will set the fan speed to follow the cooling capacity. BACKUP SET will use the BMS Backup Setpoint to drive fan speed.
S164	Allow BMS to change Fan Speed	No Yes	Yes	Enables or disables BMS fan speed control. When this parameter is disabled, the BMS will not have write capability to this point.
S165	BMS is connected to	Velocity Ana In 1 Ana In 2 Ana In 3 Ana In 4	Velocity	If the BMS is connected to Analog Input (1-4), it is used for manually writing to and controlling the unit fan speed using a low voltage control signal. If the BMS is set to Velocity (V3 or V4), it is used for manually writing to and controlling the unit fan speed via the Velocity protocol.
	BMS Analog Input Signal Type	0-5V 0-10V 4-20mA None	None	
	BMS Analog Input current value	0 - 100%	100%	
S166	High Temp Limit Approach	Disabled Supply Return	Return	Sets the sensor to be used to increase the fan speed value above the fan speed setpoint STD to the value set in the Analog Output high limit.
S16A	High Temp Limit Approach at	0 °F / +10°F 0 K / +5.5 K	2°F 1.1 K	Sets the temperature differential below the high supply and high return temperature limit where the fan speed would increase from fan speed setpoint STD to fan speed MAX.
S16B	FC / AirEco Ramp Up w/ CFC	0 = No 1 = Yes	0 (No)	Sets the selection to decouple the fan output from the call for cooling.
S168	Fan Back Draft Control	Disabled Enabled	Disabled	Enables/disables Fan Back Draft Control. This feature allows EC Fans (only) to operate at very low speeds to prevent air flow from cycling through the unit due to a high under floor static pressure than above the floor static pressure. VFDs cannot be used with this feature due to motor and/or bearing degradation that may occur at the low fan speeds required to support this feature.
S169	VSD Setpoint Back Draft	0.1 - 5.1 V	1.5 V	The variable speed device setpoint is set as a voltage reference. The lower the voltage, the slower the fans will spin. This parameter is set based on the application. Higher under floor static pressure may require a higher setting to prevent air flow through the unit.
S171	Not Selectable Zone 1 Low	0.0 - 5.0 V	3.5 V	The non-selectable zones 1 and 2 are zones that the EC fans cannot operate within due to vibration harmonics that the fans may introduce to the unit. These parameters will be set from the factory based on model type and should not need adjusted in the field.
S172	Not Selectable Zone 2 Low	0.0 - 5.0 V	0 V	The not selectable zone 1 and 2 are zones that the EC fans cannot operate within due to vibration harmonics that the fans may introduce to the unit. These parameters will be set from the factory based on model type and should not need adjusted in the field.
	Not Selectable Zone 2 High	0.0 - 5.0 V	0 V	
S173	Stop BDR when System is OFF	No Yes	No	The above is true when S173 Stop BDR when System is OFF is set to YES. If set to NO, the BDR mode will not be interrupted, unless BDR is disabled or the unit is

Table B.2 Service Menu Setpoints by Line ID (continued)

Line ID	Parameter Name	Range	Default Setting	Description
				restarted.
S175	Display Off and BDR	Off BackDraft	Off	When the back draft damper is enabled, different modes can activate this feature. Remote Off, Display Off, BMS Off, and Local Off can all be set to activate the back draft damper operation. This is done by pressing the ON/OFF key at the unit to put the unit in a Display Off condition
S176	BMS Off and BDR	Off BackDraft	Off	When the back draft damper is enabled, different modes can activate this feature. Remote Off, Display Off, BMS Off, and Local Off can all be set to activate te back draft damper operation. This is done by sending a remote OFF signal from BMS to the unit to be remotely OFF.
S177	LOC Off and BDR	Off BackDraft	Off	When the back draft damper is enabled, different modes can activate this feature. Remote Off, Display Off, BMS Off, and Local Off can all be set to activate te back draft damper operation. This is done by sending local OFF signal to the unit by pressing the ON/OFF key.
S179	SCR Control Type	None Tight Standard	None	Sets the control type for the Liebert® SCR reheats. If set to Standard, then the reheats will modulate when the temperature is below setpoint based on the control settings. If set to Tight, then one compressor will be locked on and the reheats will modulate to offset the cooling capacity.
S180	Start 1st Compressor at	-100 / +100%	0%	Sets activation point of the first compressor. This parameter can be used when set to Tight control with Liebert® SCR.
S181	Stop 1st Compressor at	-200 / +50%	-200%	Sets the deactivation point of the first compressor. This parameter can be used when set to Tight control with Liebert® SCR.
S182	1st Compressor stop delay	0 - 30 min	20 min	Sets the delay when the stop compressor setpoint for the first compressor is met.
S183	Start 2nd Compressor at	-100 / +100%	100%	Sets activation point of the second compressor. This parameter can be used when set to Tight control with Liebert® SCR.
S184	Stop 2nd Compressor ats	-200 / +50%	0%	Sets the deactivation point of the second compressor. This parameter can be used when set to Tight control with Liebert® SCR.
S185	2nd Compressor stop delay	0 - 30 min	0 min	Sets the delay when the stop compressor setpoint for the second compressor is met.
S186	Cycle Time	1.0 - 200.0 sec	1.0 sec	Set at the factory and should be changed only by an authorized Vertiv/Liebert technician.
S187	SCR Factor	1.0 - 10.0	1	Set at the factory and should be changed only by an authorized Vertiv/Liebert technician.
S188	Actual SCR request	0 - 100%	0%	Displays the actual Liebert® SCR reheat being requested.
S190	Static Pressure Fan Control	Disabled Limit Control	Disabled	Enables/disables the use of static pressure control for fan modulation.
S191	Static Pressure Setpoint inWC	0.010 - 1.003 inWC	0.020 inWC	Sets the static pressure setpoint to be used by the control to modulate the fan control.
	Static Pressure Setpoint Pa	2 - 250 Pa	5 Pa	
S192	Static Pressure	0.010 - 1.003	0.020	Sets the static pressure deadband.

Table B.2 Service Menu Setpoints by Line ID (continued)

Line ID	Parameter Name	Range	Default Setting	Description
	Deadband in WC	inWC	inWC	
	Static Pressure Deadband Pa	2 - 250 Pa	5 Pa	
S193	SP Pause Time at Deadband minimum	0 (Disabled) - 180 sec	30 sec	Sets the minimum and maximum pause times when the static pressure crosses into the deadband border. The fan speed will stop increasing or decreasing based on the time set in these parameters.
	SP Pause time at Deadband maximum	2 - 180 sec	60 sec%	
S194	SP Pulse Time inside Deadband	2 - 15 sec	3 sec	Sets the pulse time that the speed filter will be performed to the fan analog output.
S195	Static Pressure Prop Band inWC	0.010 - 1.003 inWC	0.020 inWC	Sets the proportional band for which the fan speed modulation output calculation is based upon in relation to the difference between the pressure reading the SP Setpoint.
	Static Pressure Prop Band Pa	2 - 250 Pa	5 Pa	
S196	SP During Dehum	Disabled Enabled	Disabled	Sets the use of static pressure control if dehumidification becomes active. If set to Disabled then the static pressure routines will become inactive and the fan will be allowed to ramp to the dehumidification speed set in Fan Speed Dehum/No Power. If set to Enabled, then the static pressure routines shall remain active during the call for dehumidification.
S197	Static Pressure Teamwork Mode	Average Minimum	Average	There are modes available for static pressure teamwork functionality: Average and Minimum. When selecting Average mode, the average of the lowest static pressure sensor readings in the system will be average to generate a shared static pressure value for all units in the team. The number of static pressure sensors to be averaged is set in line S198 SP Sensors in Avg for TW. When this line is set to a value lower than the number of units in the team, the lowest static pressure readings will be averaged.
S198	SP Sensors in Avg for TW	1 - 32	2	Sets the number of sensors used when averaging sensors in the teamwork.
S199	Operation on Sensor Failure	SP Off Freeze Speed	SP Off	This parameter determines what action to take if the static pressure sensor fails (non-teamwork). If SP OFF is selected, then the control will use S146 Fan Control Sensor to control the fan when the sensor is lost. If "Freeze Speed" is selected, then the control will keep the fan speed in its last known position. Situations that need to override the fan speed such as Freeze Protection can still change the fan speed.
S1A1	Static Pressure Upper Range inWC	0.010 - 1.003 inWC	0.030 inWC	The control calculates the Upper Range by using S191 "SP Setpoint" and S192 "SP Deadband", the results on lines show both values, inWC and Pa.
	Static Pressure Upper Range Pa	2.5 - 250.0 Pa	7.5 Pa	
S1A2	Static Pressure Lower Range inWC	0.000 - 0.993 inWC	0.010 inWC	The control calculates the Lower Range by using S191 SP Setpoint and S192 SP Deadband, the results on lines show both values, inWC and Pa.
	Static Pressure Lower Range Pa	0.0 - 247.5 Pa	2.5 Pa	

Table B.2 Service Menu Setpoints by Line ID (continued)

Line ID	Parameter Name	Range	Default Setting	Description
S1A4	Enable Static Pressure Control Override	None Remote Sensor Return Sensor	None	
S1A5	SP Requested Speed up to	41 - 104°F 5.0 - 40.0°C	86°F 30.0°C	
S1A6	STD Speed at	41 - 104°F 5.0 - 40.0°C	95°F 35.0°C	
S1A7	Override Integration Time	0.0 - 15.0 min	0.0 min	
S1A8	Control Slew Rate Filter	0.50 - 99.99 %/s	1.00 %/s	
S1A9	Current Override Temperature	°F °C	invalid	
S1B1	Current Override Value	0 - 100%	0%	
S1B9	Create SuperSaver Signal	0 = No 1 = Local 2 = U2U Group AVG 3 = U2U Group MAX 4 = U2U Group MIN	0 (No)	
S1C1	Deadband Low Value	5 - 95%	20%	
S1C2	Deadband High Value	10 - 100%	90%	
S1C3	Update SuperSaver Signal every	30 - 300 sec	120 sec	
S1C4	Update SuperSaver Signal by	1 - 10%	1%	
S1C5	SuperSaver Max Limit	0 - 100%	100%	
S1C6	Current SuperSaver Request	0 - 100%	0%	
	Current SuperSaver Signal	0 - 100%	0%	

Table B.2 Service Menu Setpoints by Line ID (continued)

Line ID	Parameter Name	Range	Default Setting	Description
S1C7	U2U Aggregated Signal	0 - 100%	0%	
XDU.006	Calibration Leaving Air Temperature	+/-18°F	0°F	Calibrate supply air leaving temperature sensor reading.
XDU.008	Calibration Entering Fluid Temperature	+/-18°F	0°F	Calibrate entering fluid temperature sensor reading.
XDU.007	Calibration Leaving Fluid Temperature	+/-18°F	0°F	Calibrate leaving fluid temperature sensor reading.
XDU.009	Fluid Flow Rate @ Full Scale (20mA)	10 - 1000 l/m	115 l/m	Fluid flow rate at full scale (20mA).
XDU.010	Fluid Flow Rate Setpoint	5.0 - 1000.0 l/m	50.0 l/m	Display readout showing current fluid flow rate.
XDU.011	Fluid Pump Initial Speed	30 - 100%	50%	Fluid pump initial speed percent.
XDU.012	Fluid Flow Proportional Band	1.0 - 1000 l/m	20.0 l/m	Fluid flow proportional band.
XDU.013	Fluid Flow Deadband	0.0 - 100.0 l/m	10.0 l/m	Fluid flow deadband.
XDU.014	Fluid Flow Integration Time	0 - 300 sec	60 sec	Fluid flow integration time.
XDU.018	Pump Transition Duration	0 - 30 sec	15 sec	Overlap timer for when pumps are rotating from one another.
XDU.021	Pump Sequence	0 = Auto 1 = Pump 1 2 = Pump 2	(0) Auto	Specifies which is the lead pump. If configured for auto, pumps will rotate for equal run time purposes based off a set schedule
XDU.027	Pump Rotation Frequency	0 - 30 days	7 days	Allows end user to define how often pumps should rotate.
XDU.035	Flow Switch Time Delay	1 - 9999 sec	20 sec	
XDU.052	Minimum Fluid Flow Volume	1.0 - 1000.0 l/m	5.0 l/m	Allows end user to specify minimum fluid flow.
XDU.053	Perform Pump Rotation	0 = No 1 = Yes	(0) No	Allows end user to force a pump rotation.

B.2 Line IDs for Alarm-setting Parameters

Table B.3 User Menu Alarm Settings by Line ID

Line ID	Parameter Name	Range	Default Setting	Description
U202	Return Sensor Alarms	Disabled Enabled	Enabled	Enables or disables the return sensor alarms. When enabled, the return temperature and humidity values will be compared to a high and low setting.
U203	High Return Temperature	34 - 210°F 1.0 - 99.0 °C	100°F	Allows a user to adjust the point at which the actual return temperature activates a High Temperature Alarm.
U204	Low Return Temperature	34 - 210°F 1.0 - 99.0 °C	65°F	Allows a user to adjust the point at which the actual return temperature activates the Low Temperature Alarm.
U205	High Return Humidity	1.0 - 99.0 %	65.0%	Allows a user to adjust the point at which the actual return humidity activates the High Humidity Alarm.
U206	Low Return Humidity	1.0 - 99.0 %	35.0%	Allows a user to adjust the point at which the actual return humidity activates the Low Humidity Alarm.
U207	Sensor A Alarms	Disabled Enabled	Disabled	Enables or disables the alarms for reference Sensor A. When enabled, the Sensor A temperature and humidity values will be compared to a high and low setting.
U208	High Temperature Sensor A	34 - 210°F 1.0 - 99.0 °C	90°F	Allows a user to adjust the point at which the actual Sensor A temperature activates a High Temperature Alarm.
U209	Low Temperature Sensor A	34 - 210°F 1.0 - 99.0 °C	55°F	Allows a user to adjust the point at which the actual Sensor A temperature activates a Low Temperature Alarm.
U210	High Humidity Sensor A	1.0 - 99.0 %	70.0%	Allows a user to adjust the point at which the actual Sensor A humidity activates a High Humidity Alarm.
U211	Low Humidity Sensor	1.0 - 99.0 %	30.0%	Allows a user to adjust the point at which the actual Sensor A humidity activates a Low Humidity Alarm.
U213	Supply Sensor Alarms	Disabled Enabled	Disabled	Enables or disables the supply sensor alarms. When enabled, the supply temperature value will be compared to a high and low setting.
U214	High Supply Temperature	34 - 210°F 1.0 - 99.0°C	75°F	Sets the temperature at which the High Supply Temperature Alarm is activated.
U215	Low Supply Temperature	34 - 210°F 1.0 - 99.0°C	50°F	Sets the temperature at which the Low Supply Temperature Alarm is activated.
U219	Remote Sensor Alarms	0 = Disabled 1 = Com Set 2 = Sep Set	Disabled	Enables or disables the remote sensor alarms. When enabled, the remote temperature values will be compared to a high and low setting.
U220	High Remote Temperature	34 - 210°F 1.0 - 99.0 °C	90°F	Enables or disables remote sensor temperature alarms. When enabled, the high and low remote temperature alarm will allow a user to adjust the point at which the actual remote temperature activates a High/Low temperature alarm. This parameter is used when common alarm points will be shared by all sensors. Otherwise, the remote sensors can be set individually.
	Low Remote Temperature	34 - 210°F 1.0 - 99.0 °C	55°F	
U224- U233	High Remote 01-10	34 - 210°F 1.0 - 99.0 °C	90°F	Sets the high and low remote temperature sensor alarm points individually for each sensor when the parameter separate thresholds is set to disabled

Table B.3 User Menu Alarm Settings by Line ID (continued)

Line ID	Parameter Name	Range	Default Setting	Description
	Low Remote 01-10	34 - 210°F 1.0 - 99.0 °C	55°F	
U235	Static Pressure Messages	Disabled Enabled	Disabled	Enables or disables static pressure messages.
U236	High Static Pressure (inWC)	0.010 - 1.405 inWC	1.284 inWC	Sets the pressure at which the High Static Pressure Alarm is activated (inWC, Pa)
	High Static Pressure (Pa)	2 - 350 Pa	320 Pa	
U237	Low Static Pressure (inWC)	0.000 - 1.395 inWC	0.000 inWC	Sets the pressure at which the Low Static Pressure Alarm is activated (inWC, Pa)
	Low Static Pressure (Pa)	0 - 348 Pa	0 Pa	
U238	SP Messages During Unit Off	No Yes	No	Enables or disables Static Pressure messages when the unit is OFF
U239	SP Messages on Fan Adjust	No Yes	No	Enables or disables the static pressure messages when the fan has been adjusted due to special events. These events include an adjustment for heating, humidification, dehumidification, motor overload / EC fan fault or loss of air flow.
U240	SP Transducer High Range (inWC)	0.000 - 1.405 inWC	1.284 inWC	Sets the pressure range at which the High Static Pressure Out of Range alarm is activated.
	SP Transducer High Range (Pa)	0 - 350 Pa	320 Pa	
U241	SP Transducer Low Range (inWC)	0.000 - 1.395 inWC	0.000 inWC	Sets the pressure range at which the Low Static Pressure Out of Range alarm is activated.
	SP Transducer Low Range (Pa)	0 - 348 Pa	0 Pa	

Table B.4 Service Menu Alarm Settings by Line ID

Line ID	Parameter Name	Range	Default Setting	Description
S202	Return Sensor Alarms Enable	Disabled Enabled	Enabled	Enables or disables the return temperature and humidity sensor alarms.
	Return Sensor Alarms Init Delay	10 - 9999 sec	90 sec	
S203	High Return Temperature Alarm	34 - 210°F 1.0 - 99.0°C	100°F	Sets the temperature threshold for the High/Low Return Temperature alarms.

Table B.4 Service Menu Alarm Settings by Line ID (continued)

Line ID	Parameter Name	Range	Default Setting	Description
	Low Return Temperature Alarm	34 - 210°F 1.0 - 99.0°C	65°F	
S204	High Return Humidity Alarm	1.0 - 99.0%	0.65	Sets the humidity threshold for the High/Low Return Temperature alarms.
	Low Return Humidity Alarm	1.0 - 99.0%	0.35	
S205	Sensor A Alarms Enable	Disabled Enabled	Disabled	Enables or disables the alarms associated with Sensor A and sets the time delay before the alarm is annunciated.
	Sensor A Alarms Init Delay	10 - 9999 sec	90 sec	
S206	Sensor A Low Temperature Alarm	34 - 210°F 1.0 - 99.0°C	55°F	Sets the temperature threshold when Sensor A High/Low Temperature alarm will occur
	Sensor A High Temperature Alarm	34 - 210°F 1.0 - 99.0°C	90°F	
S207	Sensor A Low Humidity Alarm	1.0 - 99.0%	30.0%	Sets the temperature threshold when Sensor A High/Low Humidity alarm will occur
	Sensor A High Humidity Alarm	1.0 - 99.0%	70.0%	
S208	Warning Activates Alarm Relay	No Yes	Yes	When set for Yes, a Warning event type will activate the Alarm Relay in addition to an Alarm event type.
S209	K11 (WA Relay) Active On	0 = Dehum 1 = Warning 2 = Emergency Pwr 3 = Freecooling 4 = FC Start	Warning	The Warning Relay (WA Relay) can be activated for different purposes; during a call of dehumidification, during a Warning event type, when unit is on Emergency Power and a Customer Input Alarm is configured for Emergency Pwr, during Free Cooling, or during Free Cooling (FC) Start.
S210	K11(WA Relay) and AL Relay	Direct Reverse	Direct	Determines whether the K11 (WA Relay) is direct or reverse acting.
S211	Water Alarm Shuts Down Unit	No Yes	No	The controller can be configured to shut the following down during an active Water Alarm: <ul style="list-style-type: none"> • Shutdown the entire unit. • Shutdown humidification operation.
	Water Alarm Hum Fill Down	No Yes	No	
S21A	Loss of Flow Compressor Timer	0 - 180 sec	0 sec	Allows setting a maximum pump down time during a loss of flow condition to prevent causing a high-pressure alarm due to pump down with no water/glycol flow to the condenser; hidden unless pump down is enabled; applies only to water/glycol cooled systems.
S21B	Loss of Flow Threshold	0 - 100%	0.1	Sets the threshold for call for cooling (CFC) loss of flow.
S213	Supply Sensor Alarms Enable	Disabled Enabled	Disabled	Enables or disables the supply sensor alarms. If the unit is not equipped with a supply temperature sensor, then this parameter will show 'Disabled'. A user may also select the time delay before the alarm will become active.
	Supply Sensor Alarms	10 - 9999 sec	90 sec	

Table B.4 Service Menu Alarm Settings by Line ID (continued)

Line ID	Parameter Name	Range	Default Setting	Description
	Init Delay			
S214	High Supply Temperature	34 - 210°F 1.0 - 99.0°C	75°F	Sets the high and low supply temperature threshold at which the alarms will be triggered.
	Low Supply Temperature	34 - 210°F 1.0 - 99.0°C	50°F	
S215	Dew Point Alarms Enable	Disabled Enabled	Disabled	Enables or disables the Return Air Dew Point alarm. Dew point alarms can be enabled with any humidity control type. Dew point alarms may be used with or without humidification or dehumidification options selected. A user may adjust the time delay before the alarm is activated.
	Dew Point Alarms Init Delay	10 - 9999 sec	90 sec	
S216	High Dew Point	34 - 210°F 1.0 - 99.0°C	59°F	Sets the high/low dewpoint threshold.
	Low Dew Point	34 - 210°F 1.0 - 99.0°C	39°F	
S217	Sensor A Dew Point Alarms Enable	Disabled Enabled	Disabled	Enables or disables the optional Sensor A Dew Point alarm. Dew point alarms can be enabled with any humidity control type. Dew point alarms may be used with or without humidification or dehumidification options selected. A user may adjust the time delay before the alarm is activated.
	Sensor A Dew Point Alarms Init Delay	10 - 9999 sec	90 sec	
S218	High Dew Point Sensor A	34 - 210°F 1.0 - 99.0°C	62°F	Sets the high/low Sensor A dew point thresholds.
	Low Dew Point Sensor A	34 - 210°F 1.0 - 99.0°C	36°F	
S219	Remote Sensor Alarms Enable	0 = Disabled 1 = Com Set 2 = Sep Set	Disabled	Disable prevents remote temperature sensor alarms from occurring. Com Set or common setting allows remote alarm activation based on a common alarm setting. Sep Set, or separate setting allows the user to program unique temperature alarm settings. A user may adjust the time delay before the alarm is activated.
	Remote Sensor Alarms Init Delay	10 - 9999 sec	180 sec	
S220	High Remote Temperature	34 - 210°F 1.0 - 99.0°C	90°F	Sets the high/low Remote Sensor alarm thresholds.
	Low Remote Temperature	34 - 210°F 1.0 - 99.0°C	55°F	
S222	EEV Alarmboard	0 = NO 1 = NC	1 (NC)	
S22A	Operation on Sensor Failure	0 = Cooling 1 = Shutdown	0 (Cooling)	Selects function to occur if the temperature control sensor fails.
	Operation on Sensor Failure Cooling Mode	0 = Full	0 (Full)	Full = Full CFC Hold = hold last CFC

Table B.4 Service Menu Alarm Settings by Line ID (continued)

Line ID	Parameter Name	Range	Default Setting	Description
		1 = Hold		
S224 - S233, S23A,	Customer Input 1 - 11	0 = Smoke 1 = Water Alarm 2 = C PMP Alarm 3 = Flow Alarm 4 = Stdby G Pump 5 = Stdby Unit 6 = C-Input 1 7 = C-Input 2 8 = C-Input 3 9 = C-Input 4 10 = Rht Lockout 11 = Hum Lockout 12 = Rht+Hum Lock 13 = Comp Lockout 14 = Call Service 15 = High Temp 16 = Air Loss 17 = FC Lockout 18 = Heater Alarm 19 = Flow AL SD 20 = Flow AL LC	1 (Water Alarm) for inputs 1-4 38 (Not Used) for inputs 5-11	Selects the device and operation of the Customer Inputs. Each event reflects a different alarm scenario and possible action to the unit. A user may select whether the customer input is normally open or normally closed. If the parameter is configured for Factory STD, then it indicates that this input is factory configured and is not configurable in the field.
S224 - S233, S23A, (Cont'd)	Customer Input 1 - 11 (Cont'd)	21 = Comp Lock PD 22 = Enable FC 23 = HTRJ VFD 24 = HTRJ SPD 25 = Fire Alarm 26 = 2nd Setpoint 27 = Emergency Pwr 28 = LSI 29 = Cond 1 Fail 30 = Cond 2 Fail 31 = D-Scroll Red 32 = Swap Valve 33 = EC Fan Fault 34 = Eco Airflow 35 = Damper Switch 36 = Power A 37 = Power B 38 = Not Used 39 = Flow AL LFC 40 = Hand Mode 41 = Fan Overrd. 42 = Cool Overrd	1 (Water Alarm) for inputs 1-4 38 (Not Used) for inputs 5-11	Selects the device and operation of the Customer Inputs. Each event reflects a different alarm scenario and possible action to the unit. A user may select whether the customer input is normally open or normally closed. If the parameter is configured for Factory STD, then it indicates that this input is factory configured and is not configurable in the field.
S224 - S233, S23A, (Cont'd)	Customer Input Active open/closed	Closed Open	Closed	A user may select if the customer input is active when contacts are open or closed.
S236	Event Delay Time (sec)	10 - 9999 sec	10 sec	Main fan overload.
	Event Enabled	Disabled Enabled	Enabled	

Table B.4 Service Menu Alarm Settings by Line ID (continued)

Line ID	Parameter Name	Range	Default Setting	Description
	Event: MAIN FAN OVERLOAD	MESSAGE WARNING ALARM	ALARM	
S237	Initial Loss of Airflow Delay	10 - 600 sec	30 sec	Loss of air flow.
	Event Delay Time (sec)	10 - 9999 sec	30 sec	
	Event Enabled	Disabled Enabled	Enabled	
	Event: LOSS OF AIRFLOW	MESSAGE WARNING ALARM	ALARM	
S238	Event Delay Time (sec)	10 - 9999 sec	10 sec	Clogged filters.
	Event Enabled	Disabled Enabled	Enabled	
	Event: CLOGGED FILTERS	MESSAGE WARNING ALARM	WARNING	
S239	Event Delay Time (sec)	10 - 9999 sec	30 sec	High room temperature.
	Event Enabled	Disabled Enabled	Enabled	
	Event: HIGH ROOM TEMP	MESSAGE WARNING ALARM	WARNING	
S240	Event Delay Time (sec)	10 - 9999 sec	30 sec	Low room temperature.
	Event Enabled	Disabled Enabled	Enabled	
	Event: LOW ROOM TEMP	MESSAGE WARNING ALARM	WARNING	
S241	Event Delay Time (sec)	10 - 9999 sec	30 sec	High room humidity.
	Event Enabled	Disabled Enabled	Enabled	
	Event: HIGH ROOM HUM	MESSAGE WARNING ALARM	WARNING	
S242	Event Delay Time (sec)	10 - 9999 sec	30 sec	Low room humidity.
	Event Enabled	Disabled Enabled	Enabled	
	Event: LOW ROOM HUM	MESSAGE WARNING ALARM	WARNING	
S243	Event Delay Time (sec)	10 - 9999 sec	30 sec	High Temperature Sensor A.
	Event Enabled	Disabled Enabled	Disabled	

Table B.4 Service Menu Alarm Settings by Line ID (continued)

Line ID	Parameter Name	Range	Default Setting	Description
	Event: HIGH TEMP SENSOR A	MESSAGE WARNING ALARM	WARNING	
S244	Event Delay Time (sec)	10 - 9999 sec	30 sec	Low Temperature Sensor A.
	Event Enabled	Disabled Enabled	Disabled	
	Event: LOW TEMP SENSOR A	MESSAGE WARNING ALARM	WARNING	
S245	Event Delay Time (sec)	10 - 9999 sec	30 sec	High Humidity Sensor A.
	Event Enabled	Disabled Enabled	Disabled	
	Event: HIGH HUM SENSOR A	MESSAGE WARNING ALARM	WARNING	
S246	Event Delay Time (sec)	10 - 9999 sec	30 sec	Low Humidity Sensor A.
	Event Enabled	Disabled Enabled	Disabled	
	Event: LOW HUM SENSOR A	MESSAGE WARNING ALARM	WARNING	
S249	Event Delay Time (sec)	—	—	Compressor 1 overload.
	Event Enabled	Disabled Enabled	Enabled	
	Event: COMP 1 OVERLOAD	MESSAGE WARNING ALARM	ALARM	
S250	Event Delay Time (sec)	—	—	Compressor 2 overload.
	Event Enabled	Disabled Enabled	Enabled	
	Event: COMP 2 OVERLOAD	MESSAGE WARNING ALARM	ALARM	
S251	Event Delay Time (sec)	—	—	Circuit 1 high pressure.
	Event Enabled	Disabled Enabled	Enabled	
	Event: CIRCUIT 1 HIGH PRESS	MESSAGE WARNING ALARM	ALARM	
S252	Event Delay Time (sec)	—	—	Circuit 2 high pressure.
	Event Enabled	Disabled Enabled	Enabled	
	Event: CIRCUIT 2 HIGH PRESS	MESSAGE WARNING ALARM	ALARM	

Table B.4 Service Menu Alarm Settings by Line ID (continued)

Line ID	Parameter Name	Range	Default Setting	Description
S253	Event Delay Time (sec)	–	–	Circuit 1 low pressure.
	Event Enabled	Disabled Enabled	Enabled	
	Event: CIRCUIT 1 LOW PRESS	MESSAGE WARNING ALARM	ALARM	
S254	Event Delay Time (sec)	–	–	Circuit 2 low pressure.
	Event Enabled	Disabled Enabled	Enabled	
	Event: CIRCUIT 2 LOW PRESS	MESSAGE WARNING ALARM	ALARM	
S255	Event Delay Time (sec)	–	–	Circuit 1 pump down failure.
	Event Enabled	Disabled Enabled	Enabled	
	Event: CIRCUIT 1 PUMPD. FAIL	MESSAGE WARNING ALARM	ALARM	
S256	Event Delay Time (sec)	–	–	Circuit 2 Pump down failure.
	Event Enabled	Disabled Enabled	Enabled	
	Event: CIRCUIT 2 PUMPD. FAIL	MESSAGE WARNING ALARM	ALARM	
S257	Event Delay Time (sec)	–	–	Digital scroll 1 high temperature.
	Event Enabled	Disabled Enabled	Enabled	
	Event: DIG SCROLL1 HIGH TEMP	MESSAGE WARNING ALARM	ALARM	
S258	Event Delay Time (sec)	–	–	Digital scroll 2 high temperature.
	Event Enabled	Disabled Enabled	Enabled	
	Event: DIG SCROLL2 HIGH TEMP	MESSAGE WARNING ALARM	ALARM	
S259	Event Reset Type	0 = AR 1 = MR	0 (AR)	Electric Heat High Temp AR = Auto Reset MR = Manual Reset
	Event Delay Time (sec)	10 - 9999 sec	10 sec	
	Event Enabled	Disabled Enabled	Enabled	
	Event: EL HEAT HIGH TEMP	MESSAGE WARNING ALARM	ALARM	
S262	Event Delay Time (sec)	10 - 9999 sec	10 sec	

Table B.4 Service Menu Alarm Settings by Line ID (continued)

Line ID	Parameter Name	Range	Default Setting	Description
	Event Enabled	Disabled Enabled	Enabled	Working hours exceeded.
	Event: UNIT HRS EXCEEDED	MESSAGE WARNING ALARM	WARNING	
S263	Event Delay Time (sec)	10 - 9999 sec	10 sec	Smoke detected.
	Event Enabled	Disabled Enabled	Enabled	
	Event: SMOKE DETECTED	MESSAGE WARNING ALARM	ALARM	
S264	Event Delay Time (sec)	10 - 9999 sec	10 sec	Water under floor.
	Event Enabled	Disabled Enabled	Enabled	
	Event: WATER UNDER FLOOR	MESSAGE WARNING ALARM	ALARM	
S265	Event Delay Time (sec)	10 - 9999 sec	10 sec	Cond pump high water
	Event Enabled	Disabled Enabled	Enabled	
	Event: COND PUMP-HIGH WATER	MESSAGE WARNING ALARM	ALARM	
S266	Event Delay Time (sec)	0 = AR 1 = MR	0 (AR)	Loss of Flow AR = Auto Reset MR = Manual Reset
	Event Enabled	10 - 9999 sec	10 sec	
	Event Number 107 Enabled	Disabled Enabled	Enabled	
	Event: LOSS OF FLOW	MESSAGE WARNING ALARM	ALARM	
S267	Event Delay Time (sec)	10 - 9999 sec	10 sec	Standby glycol pump ON.
	Event Enabled	Disabled Enabled	Enabled	
	Event: STANDBY GLYCOL PUMP ON	MESSAGE WARNING ALARM	ALARM	
S268	Event Delay Time (sec)	10 - 9999 sec	10 sec	Standby unit ON.
	Event Enabled	Disabled Enabled	Enabled	
	Event: STANDBY UNIT ON	MESSAGE WARNING ALARM	ALARM	
S269	Event Delay Time (sec)	10 - 9999 sec	10 sec	Humidifier problem.
	Event Enabled	Disabled Enabled	Enabled	
	Event: HUMIDIFIER	MESSAGE WARNING ALARM	ALARM	

Table B.4 Service Menu Alarm Settings by Line ID (continued)

Line ID	Parameter Name	Range	Default Setting	Description
	PROBLEM			
S270	Event Delay Time (sec)	10 - 9999 sec	300 sec	No connection with unit 1.
	Event Enabled	Disabled Enabled	Enabled	
	Event: NO CONNECTION W/ UNIT1	MESSAGE WARNING ALARM	WARNING	
S271	Event Delay Time (sec)	—	—	Unit X disconnected.
	Event Enabled	Disabled Enabled	Enabled	
	Event: UNIT 01 DISCONNECTED	MESSAGE WARNING ALARM	WARNING	
S272	Event: Loss of power Autoreset Delay	60 - 3600 sec	300 sec	Loss of power.
	Event Enabled	Disabled Enabled	Enabled	
	Event: LOSS OF POWER	MESSAGE WARNING ALARM	WARNING	
S275	Event Delay Time (sec)	10 - 9999 sec	10 sec	Customer input 1.
	Event Enabled	Disabled Enabled	Enabled	
	Event: CUSTOMER INPUT 1	MESSAGE WARNING ALARM	ALARM	
S276	Event Delay Time (sec)	10 - 9999 sec	10 sec	Customer input 2.
	Event Enabled	Disabled Enabled	Enabled	
	Event: CUSTOMER INPUT 2	MESSAGE WARNING ALARM	ALARM	
S277	Event Delay Time (sec)	10 - 9999 sec	10 sec	Customer input 3.
	Event Enabled	Disabled Enabled	Enabled	
	Event: CUSTOMER INPUT 3	MESSAGE WARNING ALARM	ALARM	
S278	Event Delay Time (sec)	10 - 9999 sec	10 sec	Customer input 4.
	Event Enabled	Disabled Enabled	Enabled	
	Event: CUSTOMER INPUT 4	MESSAGE WARNING ALARM	ALARM	
S279	Event Delay Time (sec)	10 - 9999 sec	10 sec	Call service.

Table B.4 Service Menu Alarm Settings by Line ID (continued)

Line ID	Parameter Name	Range	Default Setting	Description
	Event Enabled	Disabled Enabled	Enabled	
	Event: CALL SERVICE	MESSAGE WARNING ALARM	ALARM	
S280	Event Delay Time (sec)	10 - 9999 sec	10 sec	High temperature.
	Event Enabled	Disabled Enabled	Enabled	
	Event: HIGH TEMPERATURE	MESSAGE WARNING ALARM	ALARM	
S281	Event Delay Time (sec)	10 - 9999 sec	10 sec	Loss of Air Blower 1.
	Event Enabled	Disabled Enabled	Disabled	
	Event: LOSS OF AIR BLOWER 1	MESSAGE WARNING ALARM	ALARM	
S282	Event Delay Time (sec)	10 - 9999 sec	10 sec	Reheat lockout.
	Event Enabled	Disabled Enabled	Enabled	
	Event: REHEAT LOCKOUT	MESSAGE WARNING ALARM	WARNING	
S283	Event Delay Time (sec)	10 - 9999 sec	10 sec	Humidifier lockout.
	Event Enabled	Disabled Enabled	Enabled	
	Event: HUMIDIFIER LOCKOUT	MESSAGE WARNING ALARM	WARNING	
S284	Event Delay Time (sec)	10 - 9999 sec	10 sec	FC lockout.
	Event Enabled	Disabled Enabled	Enabled	
	Event: FC LOCKOUT	MESSAGE WARNING ALARM	WARNING	

Table B.4 Service Menu Alarm Settings by Line ID (continued)

Line ID	Parameter Name	Range	Default Setting	Description
S285	Compressor Lockout Option	0 = ALL 1 = 1 (A) 2 = 2 (A) 3 = 1B 4 = 2B 5 = 1A + 2A 6 = 1B + 2B 7 = 1A + 1B 8 = 2A + 2B	0 (ALL)	Compressor(s) lockout.
	Event Delay Time (sec)	10 - 9999 sec	10 sec	
	Event Enabled	Disabled Enabled	Enabled	
	Event: COMPRESSOR (S) LOCKOUT	MESSAGE WARNING ALARM	WARNING	
S27B	Edit Cust Input 1	(20 digits) 0-9 A-Z a-z &* / . + - _ : @ \	CUSTOMER INPUT 1	Edit Customer Input 1 Text.
S27C	Edit Cust Input 2	(20 digits) 0-9 A-Z a-z &* / . + - _ : @ \	CUSTOMER INPUT 2	Edit Customer Input 2 Text.
S27D	Edit Cust Input 3	(20 digits) 0-9 A-Z a-z &* / . + - _ : @ \	CUSTOMER INPUT 3	Edit Customer Input 3 Text.
S27E	Edit Cust Input 4	(20 digits) 0-9 A-Z a-z &* / . + - _ : @ \	CUSTOMER INPUT 4	Edit Customer Input 4 Text.
S288	Event Delay Time (sec)	10 - 9999 sec	10 sec	Compressor 1 short cycle.
	Event Enabled	Disabled Enabled	Enabled	
	Event: COMP 1 SHORT CYCLE	MESSAGE WARNING ALARM	WARNING	
S289	Event Delay Time (sec)	10 - 9999 sec	10 sec	Compressor 2 short cycle.
	Event Enabled	Disabled Enabled	Enabled	
	Event: COMP 2 SHORT CYCLE	MESSAGE WARNING ALARM	WARNING	

Table B.4 Service Menu Alarm Settings by Line ID (continued)

Line ID	Parameter Name	Range	Default Setting	Description
S290	Event Delay Time (sec)	10 - 9999 sec	10 sec	Emergency power.
	Event Enabled	Disabled Enabled	Enabled	
	Event: EMERGENCY POWER	MESSAGE WARNING ALARM	WARNING	
S291	Event Delay Time (sec)	10 - 9999 sec	10 sec	Condenser 1 failure.
	Event Enabled	Disabled Enabled	Enabled	
	Event: CONDENSER 1 FAILURE	MESSAGE WARNING ALARM	WARNING	
S292	Event Delay Time (sec)	10 - 9999 sec	10 sec	Condenser 2 failure.
	Event Enabled	Disabled Enabled	Enabled	
	Event: CONDENSER 2 FAILURE	MESSAGE WARNING ALARM	WARNING	
S293	Event Delay Time (sec)	10 - 9999 sec	15 sec	EC fan fault.
	Event Enabled	Disabled Enabled	Enabled	
	Event: EC FAN FAULT	MESSAGE WARNING ALARM	ALARM	
S294	Event Delay Time (sec)	10 - 9999 sec	30 sec	High supply temperature.
	Event Enabled	Disabled Enabled	Enabled	
	Event: HI SUPPLY TEMPERATURE	MESSAGE WARNING ALARM	WARNING	
S295	Event Delay Time (sec)	10 - 9999 sec	30 sec	Low supply temperature.
	Event Enabled	Disabled Enabled	Enabled	
	Event: LO SUPPLY TEMPERATURE	MESSAGE WARNING ALARM	WARNING	
S296	Event Delay Time (sec)	10 - 9999 sec	10 sec	Reduced eco air flow.
	Event Enabled	Disabled Enabled	Enabled	
	Event: REDUCED ECO AIRFLOW	MESSAGE WARNING ALARM	WARNING	
S297	Event Delay Time (sec)	10 - 9999 sec	10 sec	Eco high temperature override.
	Event Enabled	Disabled Enabled	Enabled	
	Event: ECO HI TEMP	MESSAGE WARNING ALARM	WARNING	

Table B.4 Service Menu Alarm Settings by Line ID (continued)

Line ID	Parameter Name	Range	Default Setting	Description
	OVERRIDE			
S298	Event Delay Time (sec)	10 - 9999 sec	10 sec	Temperature control sensor fail.
	Event Enabled	Disabled Enabled	Enabled	
	Event: TEMP CTRL SENSOR FAIL	MESSAGE WARNING ALARM	ALARM	
S2A2	Event Delay Time (sec)	10 - 9999 sec	30 sec	High Dew Point
	Event Enabled	Disabled Enabled	Enabled	
	Event: HIGH DEW POINT	MESSAGE WARNING ALARM	WARNING	
S2A3	Event Delay Time (sec)	10 - 9999 sec	30 sec	Low dew point.
	Event Enabled	Disabled Enabled	Enabled	
	Event: LOW DEW POINT	MESSAGE WARNING ALARM	WARNING	
S2A4	Event Delay Time (sec)	10 - 9999 sec	30 sec	High Dew Point Sensor A.
	Event Enabled	Disabled Enabled	Enabled	
	Event: HI DEW POINT SENSOR A	MESSAGE WARNING ALARM	WARNING	
S2A5	Event Delay Time (sec)	10 - 9999 sec	30 sec	Low Dew Point Sensor A.
	Event Enabled	Disabled Enabled	Enabled	
	Event: LOW DEW POINT SENSOR A	MESSAGE WARNING ALARM	WARNING	
S2A6	Event Delay Time (sec)	10 - 9999 sec	30 sec	High Remote Sensor.
	Event Enabled	Disabled Enabled	Enabled	
	—	MESSAGE WARNING ALARM	WARNING	
S2A7	Event Delay Time (sec)	10 - 9999 sec	30 sec	Low Remote Sensor.
	Event Enabled	Disabled Enabled	Enabled	
	—	MESSAGE WARNING ALARM	WARNING	
S2A8	Event Delay Time (sec)	10 - 9999 sec	10 sec	Power A failure.
	Event Enabled	Disabled Enabled	Enabled	

Table B.4 Service Menu Alarm Settings by Line ID (continued)

Line ID	Parameter Name	Range	Default Setting	Description
	Event: POWER A FAILURE	MESSAGE WARNING ALARM	ALARM	
S2A9	Event Delay Time (sec)	10 - 9999 sec	10 sec	Power B failure.
	Event Enabled	Disabled Enabled	Enabled	
	Event: POWER B FAILURE	MESSAGE WARNING ALARM	ALARM	
S2B1	Event Delay Time (sec)	10 - 9999 sec	10 sec	Airflow sensor failure.
	Event Enabled	Disabled Enabled	Enabled	
	Event: AIRFLOW SENSOR FAIL	MESSAGE WARNING ALARM	WARNING	
S2B2	Event Delay Time (sec)	10 - 9999 sec	30 sec	Humidity control sensor failure.
	Event Enabled	Disabled Enabled	Enabled	
	Event: HUM CTRL SENSOR FAILURE	MESSAGE WARNING ALARM	WARNING	
S2B6	Event Delay Time (sec)	10 - 9999 sec	120 sec	Low static pressure.
	Event Enabled	Disabled Enabled	Disabled	
	Event: LOW STATIC PRESSURE	MESSAGE WARNING ALARM	WARNING	
S2B7	Event Delay Time (sec)	10 - 9999 sec	120 sec	High static pressure.
	Event Enabled	Disabled Enabled	Disabled	
	Event: HIGH STATIC PRESSURE	MESSAGE WARNING ALARM	WARNING	
S2B8	Event Delay Time (sec)	10 - 9999 sec	150 sec	Static pressure 1 out of range.
	Event Enabled	Disabled Enabled	Disabled	
	Event: STATPR 1 OUT OF RANGE	MESSAGE WARNING ALARM	WARNING	
S2B9	Event Delay Time (sec)	10 - 9999 sec	150 sec	Static pressure 2 out of range.
	Event Enabled	Disabled Enabled	Disabled	
	Event: STATPR 2 OUT OF RANGE	MESSAGE WARNING ALARM	WARNING	
S2C1	Event Delay Time (sec)	10 - 9999 sec	150 sec	Static pressure 3 out of range.

Table B.4 Service Menu Alarm Settings by Line ID (continued)

Line ID	Parameter Name	Range	Default Setting	Description
	Event Enabled	Disabled Enabled	Disabled	
	Event: STATPR 3 OUT OF RANGE	MESSAGE WARNING ALARM	WARNING	
S2C2	Event Delay Time (sec)	10 - 9999 sec	150 sec	Static Pressure 4 out of range.
	Event Enabled	Disabled Enabled	Disabled	
	Event: STATPR 4 OUT OF RANGE	MESSAGE WARNING ALARM	WARNING	
S2C3	Event Delay Time (sec)	10 - 9999 sec	120 sec	Static Pressure 1 sensor failure.
	Event Enabled	Disabled Enabled	Disabled	
	Event: STAT PR 1 SENS FAIL	MESSAGE WARNING ALARM	ALARM	
S2C4	Event Delay Time (sec)	10 - 9999 sec	120 sec	Static Pressure 2 sensor failure.
	Event Enabled	Disabled Enabled	Disabled	
	Event: STAT PR 2 SENS FAIL	MESSAGE WARNING ALARM	ALARM	
S2C5	Event Delay Time (sec)	10 - 9999 sec	120 sec	Static Pressure 3 sensor failure.
	Event Enabled	Disabled Enabled	Disabled	
	Event: STAT PRES 3 SENS FAIL	MESSAGE WARNING ALARM	ALARM	
S2C6	Event Delay Time (sec)	10 - 9999 sec	120 sec	Static Pressure 4 sensor failure.
	Event Enabled	Disabled Enabled	Disabled	
	Event: STAT PRES 4 SENS FAIL	MESSAGE WARNING ALARM	ALARM	
S2D1	Event Delay Time (sec)	10 - 9999 sec	10 sec	Compressor 1A Overload
	Event Enabled	Disabled Enabled	Enabled	
	Event: COMP 1A OVERLOAD	MESSAGE WARNING ALARM	ALARM	
S2D2	Event Delay Time (sec)	10 - 9999 sec	10 sec	Compressor 1B overload.
	Event Enabled	Disabled Enabled	Enabled	
	Event: COMP 1B OVERLOAD	MESSAGE WARNING ALARM	ALARM	

Table B.4 Service Menu Alarm Settings by Line ID (continued)

Line ID	Parameter Name	Range	Default Setting	Description
S2D3	Event Delay Time (sec)	10 - 9999 sec	10 sec	Compressor 2A overload.
	Event Enabled	Disabled Enabled	Enabled	
	Event: COMP 2A OVERLOAD	MESSAGE WARNING ALARM	ALARM	
S2D4	Event Delay Time (sec)	10 - 9999 sec	10 sec	Compressor 2B overload.
	Event Enabled	Disabled Enabled	Enabled	
	Event: COMP 2B OVERLOAD	MESSAGE WARNING ALARM	ALARM	
S2D5	Event Delay Time (sec)	10 - 9999 sec	10 sec	Compressor 1A high temperature.
	Event Enabled	Disabled Enabled	Enabled	
	Event: COMP 1A HIGH TEMP	MESSAGE WARNING ALARM	ALARM	
S2D6	Event Delay Time (sec)	10 - 9999 sec	10 sec	Compressor 1B high temperature.
	Event Enabled	Disabled Enabled	Enabled	
	Event: COMP 1B HIGH TEMP	MESSAGE WARNING ALARM	ALARM	
S2D7	Event Delay Time (sec)	10 - 9999 sec	10 sec	Compressor 2A high temperature.
	Event Enabled	Disabled Enabled	Enabled	
	Event: COMP 2A HIGH TEMP	MESSAGE WARNING ALARM	ALARM	
S2D8	Event Delay Time (sec)	10 - 9999 sec	10 sec	Compressor 2B high temperature.
	Event Enabled	Disabled Enabled	Enabled	
	Event: COMP 2B HIGH TEMP	MESSAGE WARNING ALARM	ALARM	
S2D9	Event Delay Time (sec)	10 - 9999 sec	10 sec	Compressor 1A short cycle.
	Event Enabled	Disabled Enabled	Enabled	
	Event: COMP 1A SHORT CYCLE	MESSAGE WARNING ALARM	WARNING	
S2E1	Event Delay Time (sec)	10 - 9999 sec	10 sec	Compressor 1B Short Cycle
	Event Enabled	Disabled Enabled	Enabled	

Table B.4 Service Menu Alarm Settings by Line ID (continued)

Line ID	Parameter Name	Range	Default Setting	Description
	Event: COMP 1B SHORT CYCLE	MESSAGE WARNING ALARM	WARNING	
S2E2	Event Delay Time (sec)	10 - 9999 sec	10 sec	Compressor 2A short dycle.
	Event Enabled	Disabled Enabled	Enabled	
	Event: COMP 2A SHORT CYCLE	MESSAGE WARNING ALARM	WARNING	
S2E5	Event Delay Time (sec)	10 - 9999 sec	10 sec	Compressor 2B short cycle.
	Event Enabled	Disabled Enabled	Enabled	
	Event: COMP 2B SHORT CYCLE	MESSAGE WARNING ALARM	WARNING	
S2E6	Event Delay Time (sec)	10 - 9999 sec	60 sec	GCB ambient temperature differential.
	Event Enabled	Disabled Enabled	Enabled	
	Event: GCD AMBIENT TEMP DIFF	MESSAGE WARNING ALARM	WARNING	
S2E7	—	—	—	C1 freeze protection.
	Event Enabled	Disabled Enabled	Enabled	
	Event: C1 FREEZE PROTECTION	MESSAGE WARNING ALARM	ALARM	
S2E8	—	—	—	C2 freeze protection.
	Event Enabled	Disabled Enabled	Enabled	
	Event: C2 FREEZE PROTECTION	MESSAGE WARNING ALARM	ALARM	
S2E9	Event Delay Time (sec)	10 - 9999 sec	10 sec	Damper failure.
	Event Enabled	Disabled Enabled	Enabled	
	Event: DAMPER FAILURE	MESSAGE WARNING ALARM	ALARM	
SF2F	—	—	—	BMS disconnected.
	Event Enabled	Disabled Enabled	Enabled	
	Event: BMS DISCONNECTED	MESSAGE WARNING ALARM	WARNING	
S2F9	Phase Loss MB01 shuts unit down	0 = No 1 = Yes	1 (Yes)	Power 1 phase loss.
	Event Delay Time (sec)	10 - 9999 sec	10 sec	

Table B.4 Service Menu Alarm Settings by Line ID (continued)

Line ID	Parameter Name	Range	Default Setting	Description
	Event Enabled	Disabled Enabled	Enabled	
	Event: POWER 1 PHASE LOSS	MESSAGE WARNING ALARM	ALARM	
S2G1	Phase Loss MB02 shuts unit down	0 = No 1 = Yes	1 (Yes)	Power 2 phase loss.
	Event Delay Time (sec)	10 - 9999 sec	10 sec	
	Event Enabled	Disabled Enabled	Enabled	
	Event: POWER 2 PHASE LOSS	MESSAGE WARNING ALARM	ALARM	
S2G2	Phase Loss MB03 shuts unit down	0 = No 1 = Yes	1 (Yes)	Power 3 phase loss.
	Event Delay Time (sec)	10 - 9999 sec	10 sec	
	Event Enabled	Disabled Enabled	Enabled	
	Event: POWER 3 PHASE LOSS	MESSAGE WARNING ALARM	ALARM	
S2G3	Phase Loss MB04 shuts unit down	0 = No 1 = Yes	1 (Yes)	Power 4 phase loss.
	Event Delay Time (sec)	10 - 9999 sec	10 sec	
	Event Enabled	Disabled Enabled	Enabled	
	Event: POWER 4 PHASE LOSS	MESSAGE WARNING ALARM	ALARM	
S2G4	Phase Loss MB05 shuts unit down	0 = No 1 = Yes	1 (Yes)	Power 5 phase loss.
	Event Delay Time (sec)	10 - 9999 sec	10 sec	
	Event Enabled	Disabled Enabled	Enabled	
	Event: POWER 5 PHASE LOSS	MESSAGE WARNING ALARM	ALRM	
S2G5	Phase Loss MB06 shuts unit down	0 = No 1 = Yes	1 (Yes)	Power 6 phase loss.
	Event Delay Time (sec)	10 - 9999 sec	10 sec	
	Event Enabled	Disabled Enabled	Enabled	
	Event: POWER 6 PHASE LOSS	MESSAGE WARNING ALARM	ALARM	
S2G6	Event Delay Time	10 - 9999 sec	60 sec	Flow sensor fail C1.

Table B.4 Service Menu Alarm Settings by Line ID (continued)

Line ID	Parameter Name	Range	Default Setting	Description
	(sec)			
	Event Enabled	Disabled Enabled	Enabled	
	Event: FLOW SENSOR FAIL C1	MESSAGE WARNING ALARM	WARNING	
S2G7	Event Delay Time (sec)	10 - 9999 sec	60 sec	Flow sensor fail C2.
	Event Enabled	Disabled Enabled	Enabled	
	Event: FLOW SENSOR FAIL C2	MESSAGE WARNING ALARM	WARNING	
S2G8	Event Delay Time (sec)	10 - 9999 sec	60 sec	TSA sensor fail.
	Event Enabled	Disabled Enabled	Enabled	
	Event: TSA SENSOR FAIL	MESSAGE WARNING ALARM	ALARM	
617	Event Delay Time (sec)	1 - 9999 sec	10 sec	Liebert® XDU pump inverter fail 1.
	Event Enabled	Disabled Enabled	Enabled	
	Event: PUMP INVERTER FAIL 1	MESSAGE WARNING ALARM	ALARM	
618	Event Delay Time (sec)	1 - 9999 sec	10 sec	Liebert® XDU pump inverter fail 2.
	Event Enabled	Disabled Enabled	Enabled	
	Event: PUMP INVERTER FAIL 2	MESSAGE WARNING ALARM	ALARM	
619	Event Delay Time (sec)	1 - 9999 sec	10 sec	Liebert® XDU pump flow fail 1.
	Event Enabled	Disabled Enabled	Enabled	
	Event: PUMP FLOW FAIL 1	MESSAGE WARNING ALARM	ALARM	
620	Event Delay Time (sec)	1 - 9999 sec	10 sec	Liebert® XDU pump flow fail 2.
	Event Enabled	Disabled Enabled	Enabled	
	Event: PUMP FLOW FAIL 2	MESSAGE WARNING ALARM	ALARM	
621	Event Delay Time (sec)	1 - 9999 sec	10 sec	Liebert® XDU fluid flow check filter.
	Event Enabled	Disabled Enabled	Enabled	
	Event: CHECK WATER	MESSAGE WARNING ALARM	WARNING	

Table B.4 Service Menu Alarm Settings by Line ID (continued)

Line ID	Parameter Name	Range	Default Setting	Description
	SYSTEM			
622	Event Delay Time (sec)	1 - 9999 sec	10 sec	The current Liebert® XDU supply fluid temperature is above the threshold.
	Event Enabled	DisabledEnabled	Enabled	
	Event: HIGH SUPPLY WATER TEMP	MESSAGEWARNINGALARM	WARNING	
623	Event Delay Time (sec)	1 - 9999 sec	10 sec	The current Liebert® XDU return fluid temperature is above the threshold.
	Event Enabled	DisabledEnabled	Enabled	
	Event: HIGH RETURN WATER TEMP	MESSAGEWARNINGALARM	WARNING	
624	Event Delay Time (sec)	1 - 9999 sec	10 sec	Liebert® XDU pump operation with no flow.
	Event Enabled	DisabledEnabled	Enabled	
	Event: PUMP OPERATION WITH NO FLOW	MESSAGEWARNINGALARM	ALARM	
625	Event Delay Time (sec)	1 - 9999 sec	10 sec	Liebert® XDU supply fluid sensor failure.
	Event Enabled	DisabledEnabled	Enabled	
	Event: SUPPLY FLUID SENSOR FAILURE	MESSAGEWARNINGALARM	ALARM	
626	Event Delay Time (sec)	1 - 9999 sec	10 sec	Liebert® XDU return fluid sensor failure.
	Event Enabled	DisabledEnabled	Enabled	
	Event: RETURN FLUID SENSOR FAILURE	MESSAGEWARNINGALARM	ALARM	
627	Event Delay Time (sec)	1 - 9999 sec	10 sec	Liebert® XDU fluid flow sensor failure.
	Event Enabled	DisabledEnabled	Enabled	
	Event: FLOW SENSOR FAILURE	MESSAGEWARNINGALARM	ALARM	
628	Event Delay Time (sec)	1 - 9999 sec	-	Current working hours of fluid pump 1 are above the threshold.
	Event Enabled	DisabledEnabled	Enabled	
	Event: PUMP 1 HOURS EXCEEDED	MESSAGEWARNINGALARM	WARNING	

Table B.4 Service Menu Alarm Settings by Line ID (continued)

Line ID	Parameter Name	Range	Default Setting	Description
629	Event Delay Time (sec)	1 - 9999 sec	-	Current working hours of fluid pump 2 are above the threshold.
	Event Enabled	Disabled/Enabled	Enabled	
	Event: PUMP 2 HOURS EXCEEDED	MESSAGEWARNINGALARM	WARNING	

B.3 Line IDs for Cascade Operation Parameters

Table B.5 Service Menu Cascade Parameters by Line ID

Line ID	Parameter Name	Range	Default Setting	Description
S515	Cascade Units	No Yes Cool/Heat Cooling Fan PI Fanspeed	No	User may select the method to which the next standby unit will stage ON. <ul style="list-style-type: none"> No = disabled Yes = enabled via TW Mode 1 Cool/Heat = enabled via TW Mode 1 Cooling = enabled via TW Mode 1 Fan PI = enabled via TW Mode 3 Fanspeed = enabled via TW Mode 3
S516	Cascaded Units Delay	0 - 30 min	10 min	This is the amount of time that must pass prior to the standby unit staging ON, once a standby unit receives an ON command from the Master (U2U 1).
S517	Cascaded Units Quick Start	0 - 30 min	2 min	After the Master (U2U 1) has restarted after a power cycle; this control delay time is used (shorter time than S516). The timer changes back to using S516 when the time of power cycle is equal to S517 min/sec. NOTE: This setting is not required. If set to a value of 0, then S517 Cascade Units Quick Start is disabled.
	Cascaded Units QS Delay	15 - 1800 sec	120 sec	
S518	Cascaded Units Control Delay	0 - 30 min	5 min	This is the amount of time that must pass before the normal unit control is used, once a standby unit has been cascaded ON.
S519	Cascaded Units OFF Delay	0 - 360 min	0 min	This timer starts to count down once a cascaded ON system has received an OFF request from the master; the cascaded unit will stop after this timer and S520 have elapsed.
S520	Cascaded Units Min Run	2 - 360 min	30 min	This is the minimum ON time the cascaded system will run, once energized, before staging OFF.
S521	Start Next Unit @ SYS Fanspeed	50 - 100%	100%	When the System (network) fan speed operates at or above S521, S516 timer is started. Once S516 has elapsed, the next single unit will energized. NOTE: Fan speed must be at or continuously above value set in S521. The timer restarts any time the fan speed falls below the value in S521.

Table B.5 Service Menu Cascade Parameters by Line ID (continued)

Line ID	Parameter Name	Range	Default Setting	Description
S522	Max. Intermediate System Speed	50 - 100%	100%	Defines the value to which the System (network) fan speed may increase to when not all units in the network are in operation
S523	Stop Next Unit @ SYS Fanspeed	20 - 70%	70%	When the current System (network) fan speed operates at or below S523, two timers must elapse before the cascaded ON unit turns OFF, S519 and S520.
S524	Cascaded Units OFF Master Delay	0 - 360 min	1 min	In the event of the Virtual Master taking control; the new Master unit shall control the staging OFF of currently operating units for the amount of time set in S524. After S524 time has elapsed, S519 value is used.

Appendix C: Submittal Drawings

Table C.1 Submittal Drawing Contents

Document Number	Title
Wall Mount Displays	
DPN004840	Liebert® Mini-Mate Variable Capacity Unit-to-Unit Network Connections Two or More 3 Ton Units Networked Using Switch
DPN004841	Liebert® Mini-Mate Variable Capacity Unit-to-Unit Network Connections Two or More 4-5 Ton Units Networked Using Switch

This page intentionally left blank

UNIT TO UNIT NETWORK CONNECTIONS TWO 3 TON UNITS NETWORKED

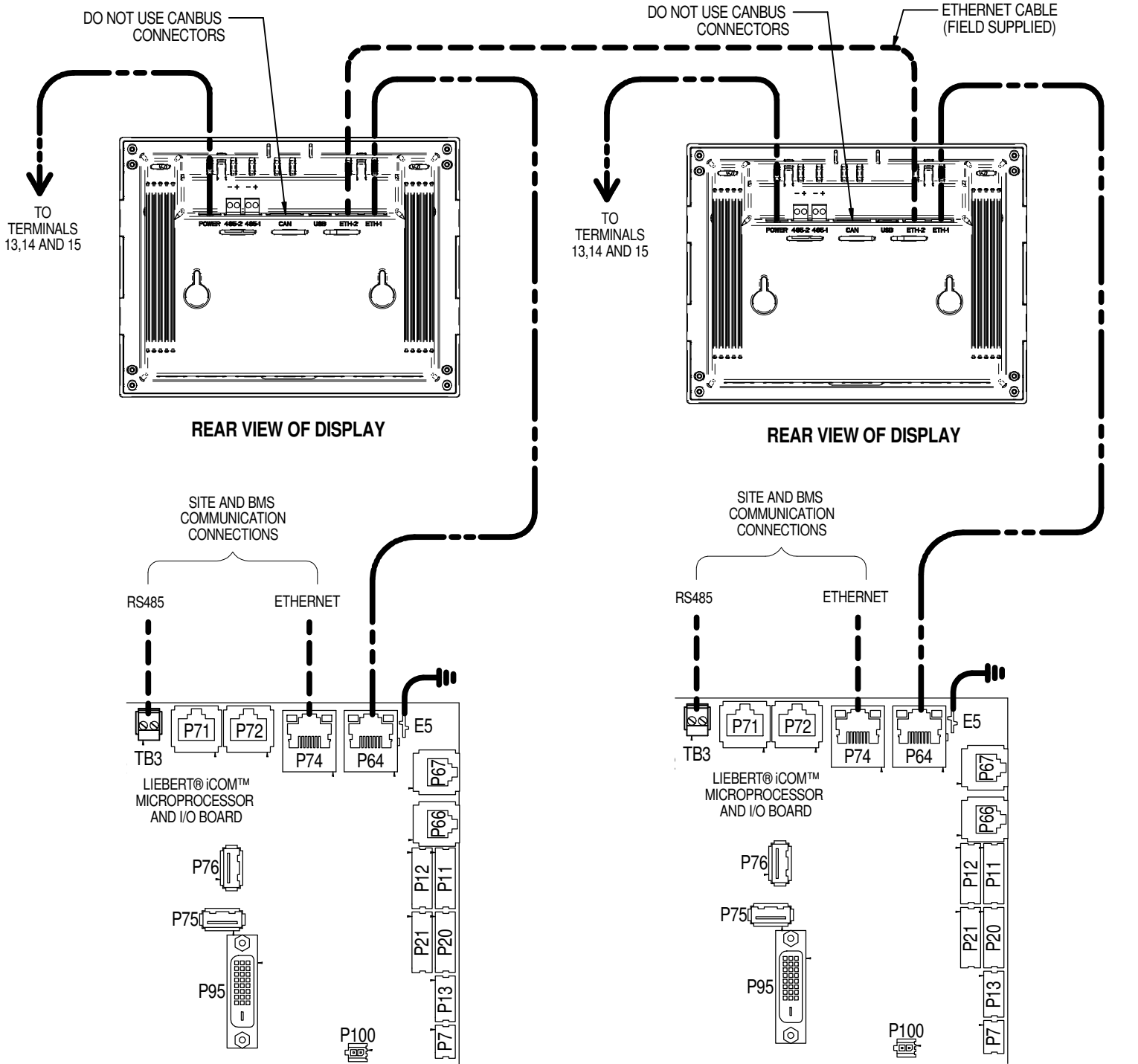

Notes:

1. Refer to DPN004802 for connection points on Liebert Mini-Mate Variable Capacity unit.
2. Refer to DPN004803 for general arrangement and field connections.

- Field Supplied Wiring - Unit Networking & Site BMS
- Field Supplied Wiring - Individual Display
- Factory Supplied Ground Wire

UNIT TO UNIT NETWORK CONNECTIONS

TWO OR MORE 3 TON UNITS NETWORKED USING SWITCH

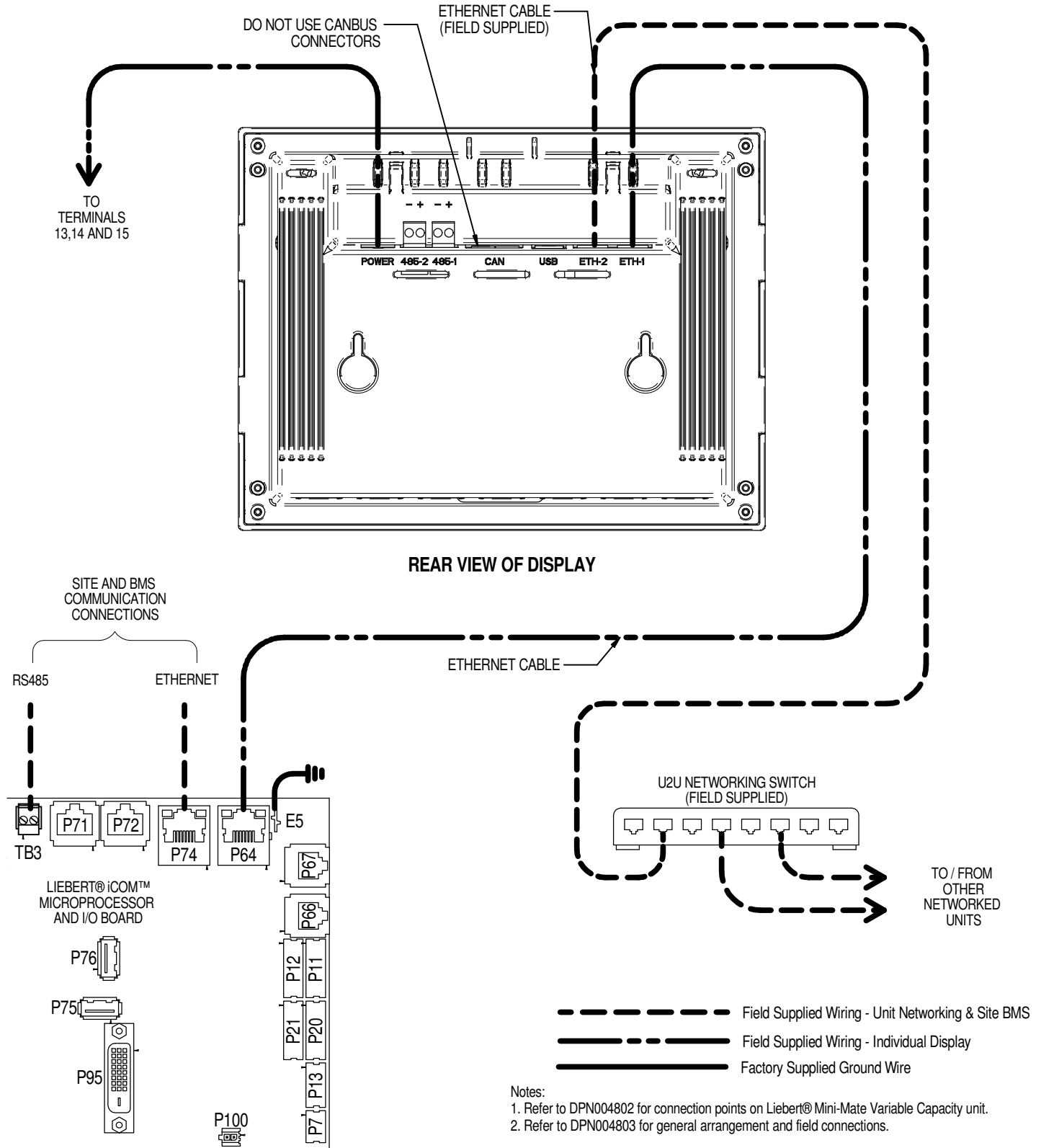

UNIT TO UNIT NETWORK CONNECTIONS TWO 4-5 TON UNITS NETWORKED

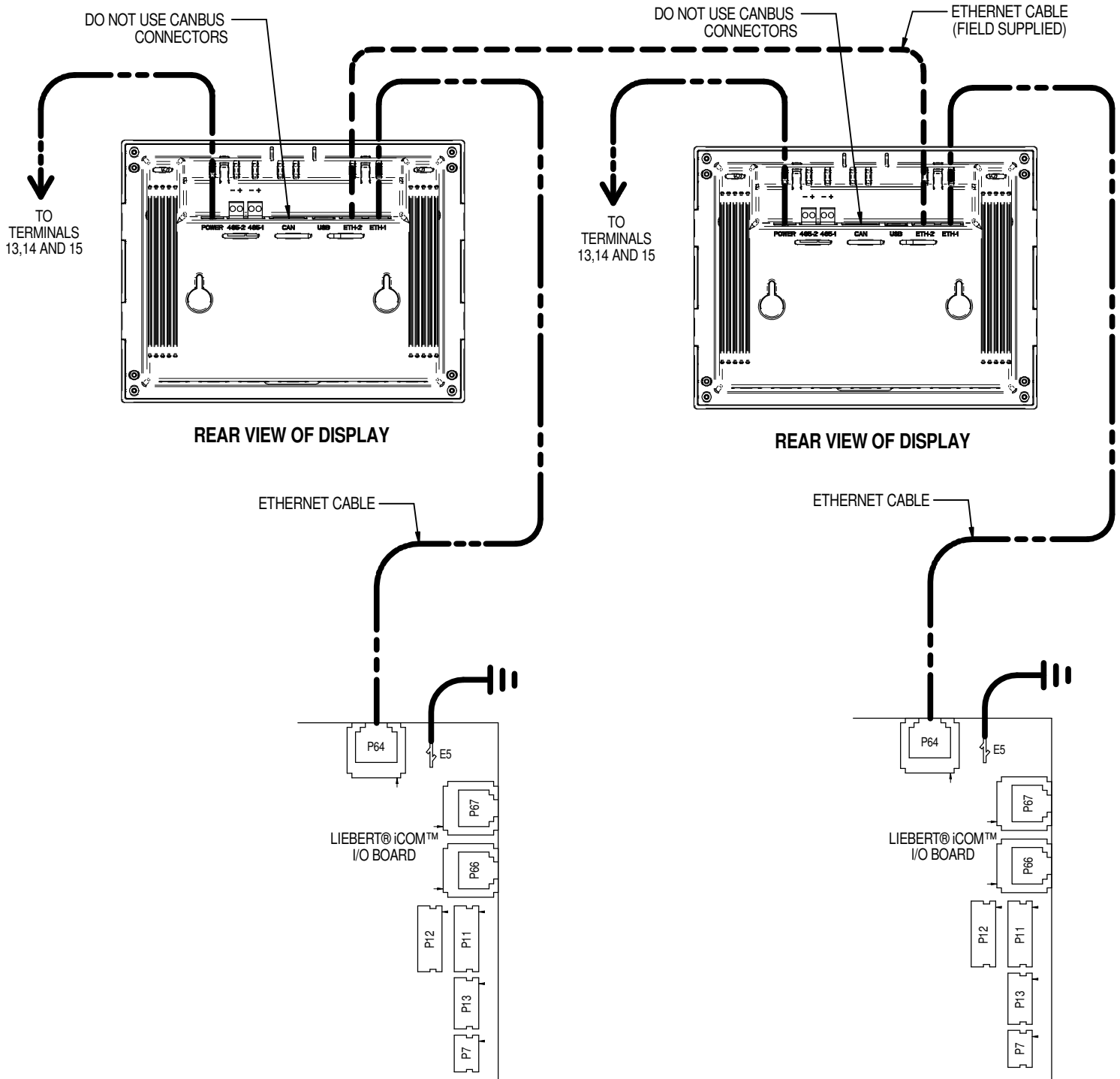

- Notes:
1. Refer to DPN004057 for connection points on Liebert® Mini-Mate Variable Capacity unit.
 2. Refer to DPN004238 for general arrangement and field connections.

- Field Supplied Wiring - Unit Networking
- Field Supplied Wiring - Individual Display
- Factory Supplied Ground Wire

UNIT TO UNIT NETWORK CONNECTIONS

TWO OR MORE 4-5 TON UNITS NETWORKED USING SWITCH

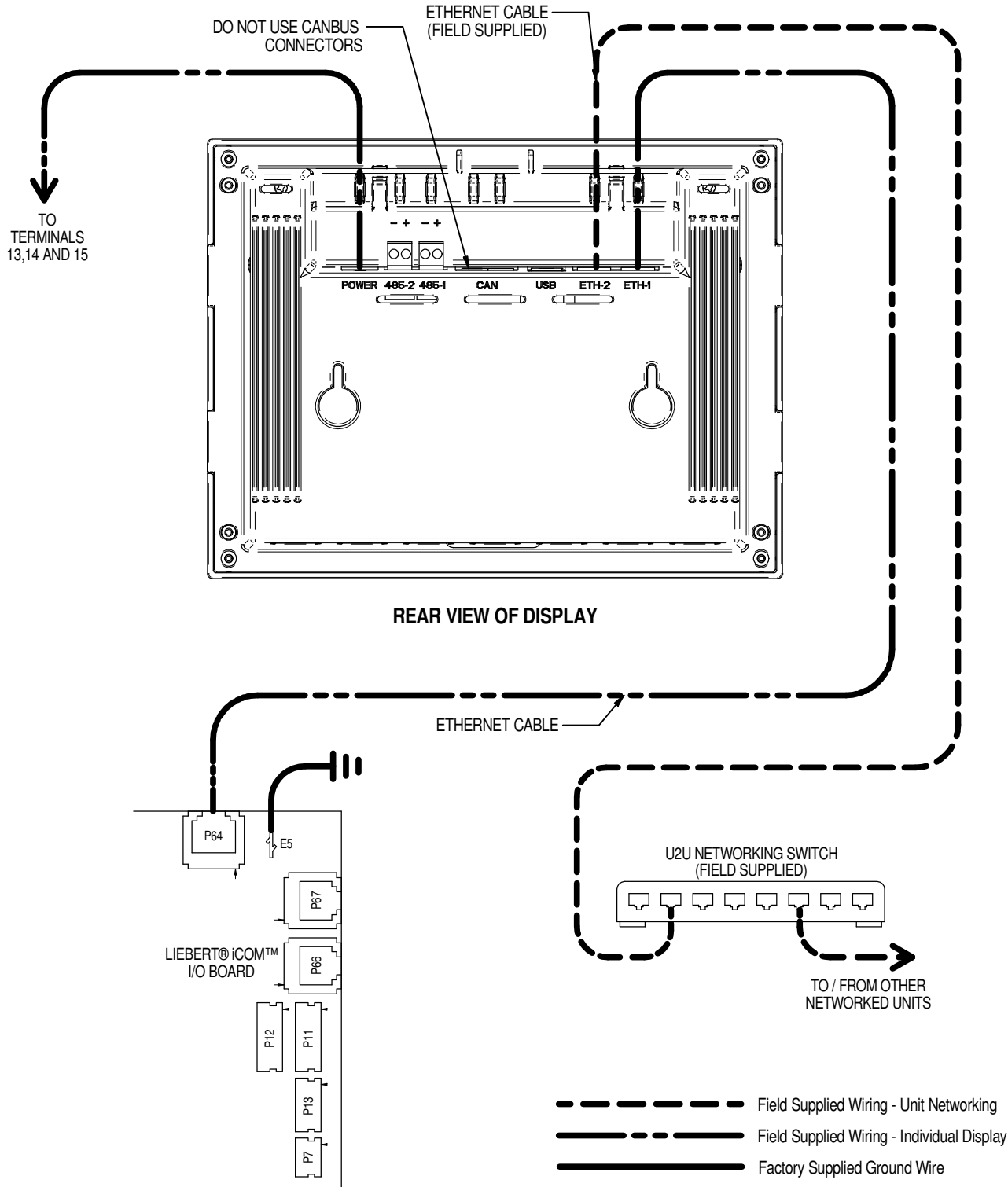

Notes:

1. Refer to DPN004057 for connection points on Liebert® Mini-Mate Variable Capacity unit.
2. Refer to DPN004238 for general arrangement and field connections.

Connect with Vertiv on Social Media



<https://www.facebook.com/vertiv/>



<https://www.instagram.com/vertiv/>



<https://www.linkedin.com/company/vertiv/>



<https://www.x.com/Vertiv/>



Vertiv.com | Vertiv Headquarters, 505 N Cleveland Ave, Westerville, OH 43082 USA

©2026 Vertiv Group Corp. All rights reserved. Vertiv™ and the Vertiv logo are trademarks or registered trademarks of Vertiv Group Corp. All other names and logos referred to are trade names, trademarks or registered trademarks of their respective owners. While every precaution has been taken to ensure accuracy and completeness here, Vertiv Group Corp. assumes no responsibility, and disclaims all liability, for damages resulting from use of this information or for any errors or omissions.

SL-11966_REV7_03-26