



Liebert® DCDactive Fan Module

User Manual

The information contained in this document is subject to change without notice and may not be suitable for all applications. While every precaution has been taken to ensure the accuracy and completeness of this document, Vertiv assumes no responsibility and disclaims all liability for damages resulting from use of this information or for any errors or omissions.

Vertiv recommends installing a monitored fluid detection system that is wired to activate the automatic closure of field-installed coolant fluid supply and return shut off valves, where applicable, to reduce the amount of coolant fluid leakage and consequential equipment and building damage. Refer to local regulations and building codes relating to the application, installation, and operation of this product. The consulting engineer, installer and/or end user is responsible for compliance with all applicable laws and regulations relating to the application, installation, and operation of this product.

The products covered by this instruction manual are manufactured and/or sold by Vertiv. This document is the property of Vertiv and contains confidential and proprietary information owned by Vertiv. Any copying, use or disclosure of it without the written permission of Vertiv is strictly prohibited.

Names of companies and products are trademarks or registered trademarks of the respective companies. Any questions regarding usage of trademark names should be directed to the original manufacturer.

Technical Support Site

If you encounter any installation or operational issues with your product, check the pertinent section of this manual to see if the issue can be resolved by following outlined procedures.

Visit <https://www.vertiv.com/en-us/support/> for additional assistance.

TABLE OF CONTENTS

1 Important Safety Instructions	1
1.1 CE Declaration of Conformity	4
1.2 North American Standards Conformity	5
2 Product Specifications	7
3 Vertiv™ Liebert® DCD and Vertiv™ Liebert® DCDactive Unit Code Table	9
3.1 Component Locations	12
3.2 Layout of the Unit Components	13
4 Options and Accessories	15
4.1 Option Monitoring Package and Display	15
4.2 Option A/B Transfer Switch	16
4.3 Accessories	16
5 General Information	17
5.1 Intended Use	17
5.2 Repair during Live Operation	17
5.3 Description of Functions	17
5.3.1 Standard Version	18
5.3.2 Redundant A/B Power Supply	18
5.3.3 Monitoring Package with Display and Sensors	18
5.3.4 Self-Diagnosis and Messages	19
6 Installation and Commissioning	21
6.1 Installation	24
6.2 Optional Connection of the General Alarm	32
6.3 Optional Connection of the OneWire Sensor Adapter	34
6.4 Installation and Connection of the Door Contact Switch	35
6.5 Installation and Connection the Leak Sensor	36
6.6 Installation and Connection of the Water Flow Modulating Valve	37
6.7 Optional Connection of the Supply and Return Water Temperature Sensor	38
7 Operation	39
7.1 Menu of the TFT Display	39
7.1.1 Main Screen with Detailed Menus	39
7.1.2 Settings Menu	43
7.1.3 Set-up Menu	54
7.2 Teaching Sensors	56
8 MODBUS TCP/IP Specification	61
8.1 Connection Settings	61
8.2 Activate Default Values	62
8.3 Data Points	64
8.4 Writeable Data Points	67

9 Water Flow Modulating Valve	69
9.1 Connections	69
9.2 Technical Data	70
9.3 Installation Instructions	71
9.4 Dimensions	72
10 Spare Parts List	73

1 Important Safety Instructions



WARNING! Arc flash and electric shock hazard. Can cause serious injury or death. Building and equipment damage may also result. Disconnect all local and remote electric power supplies and wear appropriate, OSHA-approved personal protective equipment (PPE) per NFPA 70E before working within the electric control enclosure. Customer must provide earth ground to unit, per NEC, CEC and local codes, as applicable. Verify with a voltmeter that power is Off. The Vertiv™ Liebert® controller does not isolate power from the unit, even in the “Unit Off” mode. Some internal components still require and receive power even during the “Unit Off” mode of the controller. The factory-supplied, optional disconnect switch is inside the unit. The line side of this switch contains live high voltage. The only way to ensure that there is NO voltage inside the unit is to install and open a remote disconnect switch. Refer to unit electrical schematic. Before proceeding with installation, read all instructions, verify that all the parts are included and check the nameplate to be sure the voltage matches available utility power. Follow all local codes.



WARNING! Risk of electric shock. Can cause serious injury or death. Building and equipment damage may also result. Open all local and remote electric power supply disconnect switches and verify that power is off with a voltmeter before working within any electric connection enclosures. The Liebert® controller does not isolate power from the unit, even in the "Unit Off" mode. Some internal components require and receive power even during the "unit off" mode of the Liebert® controller. Installation, service, and maintenance work must be performed only by properly trained and qualified personnel and in accordance with applicable regulations and manufacturers' specifications. Opening or removing the covers to any equipment may expose personnel to lethal voltages within the unit even when it is apparently not operating and the input wiring is disconnected from the electrical source.



WARNING! Risk of short circuits and electric shock. Can cause serious injury or death. Building and equipment damage can result from cut insulation or damaged wires. Can cause overheated wiring, smoke, fire, activation of fire suppression systems and EMS personnel, and loss of power to fans. Verify that all wiring connections are tight and that all wiring is contained within the junction box prior to closing and securing the cover. Insert CSA-certified or UL-listed bushings into holes and/or knockouts used to route wiring through metal panels to protect the wire insulation from contact with sheet metal edges.



WARNING! Risk of improper wire sizing/rating and loose electrical connections causing overheated wire and electrical connection terminals resulting in smoke or fire. Can cause serious injury or death. Building and equipment damage may also result. Use correctly sized copper wire only and verify that all electrical connections are tight before turning power On. Check all electrical connections periodically and tighten as necessary.



WARNING! Risk of improper wiring, piping, moving, lifting and handling. Can cause serious injury or death. Building and equipment damage may also result. Installation and service of this equipment should be done only by qualified personnel who have been specially-trained in the installation of air-conditioning equipment and who are wearing appropriate, OSHA-approved PPE.



CAUTION: Risk of contact with high-speed rotating fan blades. Can cause serious injury. Open all local and remote electric power-supply disconnect switches, verify with a voltmeter that power is off, and verify that all fan blades have stopped rotating before working in the unit cabinet or on the fan assembly. If control voltage is applied, the fan motor can restart without warning after a power failure. Do not operate the unit with any or all cabinet panels removed.



CAUTION: Risk of accidents and injuries. There is a risk of injury due to electric shock and rapidly rotating parts. Repairs during live operation may only be carried out by qualified personnel with sufficient expertise, knowledge of the hazards and appropriate protective equipment.



CAUTION: Risk of contact with sharp edges, splinters and exposed fasteners. Can cause injury. Only properly trained and qualified personnel wearing appropriate, OSHA-approved PPE should attempt to move, lift, remove packaging from or prepare the unit for installation.



CAUTION: Risk of contact with hot surfaces. Can cause injury. Personal burn injury can be the result of touching an electronics housing, fan motor, and some electrical components that are extremely hot during unit operation. Allow sufficient time for them to cool to a touch-safe temperature before working within the unit cabinet.

Use extreme caution and wear appropriate, OSHA-approved PPE when working on or near hot components, including when replacing or performing maintenance on the fans.



CAUTION: Risk of improper piping installation, leak checking, fluid chemistry and fluid maintenance. Can cause injury. Building and equipment damage may also result. Installation and service of this equipment should be done only by qualified personnel who have been specially-trained in the installation of air-conditioning equipment and who are wearing appropriate, OSHA-approved PPE.

NOTICE

Risk of improper power-supply connection. Can cause equipment damage and loss of warranty coverage.

Prior to connecting any equipment to a main or alternate power source (for example back-up generator systems) for start-up, commissioning, testing, or normal operation, ensure that these sources are correctly adjusted to the nameplate voltage and frequency of all equipment to be connected. In general, power-source voltages should be stabilized and regulated to within +/- 10% of the load nameplate nominal voltage.

See transformer label for primary tap connections. Installer will need to change transformer primary taps if applied unit voltage is other than pre-wired tap voltage.

NOTICE

Risk of piping-system corrosion and freezing fluids. Can cause leaks resulting in equipment and very expensive building damage. Heat exchangers and piping systems are at high risk of freezing and premature corrosion. Fluids in these systems must contain the proper antifreeze and inhibitors to prevent freezing and premature coil and piping corrosion. When the cooling unit or piping may be exposed to freezing temperatures, charge the system with coolant fluid based on the coldest ambient design temperature. Automotive antifreeze is unacceptable and must NOT be used in any fluid system. Use only coolant fluid solution that meets the requirements of recommended industry practices. Do not use galvanized pipe.

The system coolant fluid must be analyzed by a competent fluid-treatment specialist before start up to establish the inhibitor and antifreeze solution requirement and evaluated at regularly scheduled intervals throughout the life of the system to determine the pattern of inhibitor depletion.

The fluid complexity and variants of required treatment programs make it extremely important to obtain the advice of a competent and experienced fluid-treatment specialist and follow a regularly scheduled coolant-fluid system-maintenance program.

Fluid chemistry varies greatly as do the required additives, called inhibitors, that reduce the corrosive effect of the fluids on the piping systems and components.

The chemistry of the coolant fluid used must be considered, because some sources may contain corrosive elements that reduce the effectiveness of the inhibited formulation. Sediment deposits prevent the formation of a protective oxide layer on the inside of the coolant system components and piping. The coolant fluid must be treated and circulating through the system continuously to prevent the buildup of deposits and/or growth of sulfate reducing bacteria. Proper inhibitor maintenance must be performed to prevent corrosion of the system.

Consult fluid manufacturer for testing and maintenance of inhibitors.

Commercial-grade coolant fluid is generally less corrosive to the common metals of construction than water itself. It will, however, assume the corrosivity of the coolant fluid from which it is prepared and may become increasingly corrosive with use if not properly inhibited.

Vertiv recommends installing a monitored fluid-detection system that is wired to activate the automatic-closure of field-installed coolant-fluid supply and return shut-off valves to reduce the amount of coolant-fluid leakage and consequential equipment and building damage. The shut-off valves must be sized to close-off against the maximum coolant-fluid system pressure in case of a catastrophic fluid leak.

NOTE: Changes and modifications to this controller, as well as opening the lid of the unit, are not permitted and shall absolve the manufacturer from any warranty obligations or liability.

NOTICE

Risk of no-flow condition. Can cause equipment damage. Do not leave the water/coolant fluid-supply circuit in a no-flow condition. Idle fluid allows the collection of sediment that prevents the formation of a protective oxide layer on the inside of the tubes. Keep unit switched On and water/ coolant fluid-supply circuit system operating continuously. In multiple unit teams, allow standby units to enter the rotation automatically or schedule regular manual rotations.

NOTICE

Risk of leaking chilled water lines. Can cause equipment and building damage.

Lines and joints must be inspected regularly. Improper installation, application and service practices can result in water leakage from the unit. Water leakage can result in severe property damage and loss of critical data center equipment. Do not locate unit directly above any equipment that could sustain water damage.

Vertiv recommends installing monitored leak detection equipment for the unit and supply and return lines.

NOTICE

Risk of a catastrophic water circuit rupture. Can cause expensive building and equipment damage.

Install an overflow drain pan under the unit with a monitored leak detection system in the pan and shutoff valves in the supply and return water lines that automatically close if water is detected by the leak detection system. The shutoff valves should be spring return and must be rated for a close-off pressure that is the same as or higher than the supply water pressure. If it is not possible to install an overflow drain pan, then a monitored leak detection system should be installed in the base of the unit or under the unit to actuate the shutoff valves immediately on a leak detection signal.

The overflow drain pan should have a drain line connected to it that flows to a floor drain or maintenance sink in case of a shutoff valve or leak detection system malfunction.

NOTICE

Risk of passageway interference. Can cause unit and/or structure damage. The unit may be too large to fit through a passageway while on or off the skid. Measure the unit and passageway dimensions, and refer to the installation plans prior to moving the unit to verify clearances.

NOTICE

Risk of damage from forklift. Can cause unit damage. Keep tines of the forklift level and at a height suitable to fit below the skid and/or unit to prevent exterior and/or underside damage.

NOTICE

Risk of improper storage. Can cause unit damage. Keep the unit upright, indoors and protected from dampness, freezing temperatures and contact damage.

NOTICE

Risk of improper control circuits. Can cause equipment damage. When using jumpers for troubleshooting, always remove jumpers when maintenance is complete. Jumpers left connected could override controls and cause equipment damage.

1.1 CE Declaration of Conformity

Vertiv™ Liebert® DCDactive Fan Module conforms to the following European directives:

2014/35/EU

Directive of the council for adapting the legal regulations of member states on electrical equipment for use within specific voltage limits (superseding 2006/95/EC and successive amendments).

2014/30/EU

Directive of the council for adapting the legal regulations of member states on electromagnetic compatibility, (superseding 2004/108/EC and successive amendments).

Conformity is established through compliance with the following standards:

- IEC/EN 62040-1+A1:2013
- IEC/EN 62040-2:2006

Additional information regarding adherence to these directives is included in the appendices NSR and EMC to the Declaration of Conformity. If needed, the Declaration of Conformity can be requested from Vertiv.

2011/65/EU

Directive of the council for adapting the legal regulations of member states on the restriction of the use of certain hazardous substances that can be used in the manufacture of electrical and electronic equipment.

1.2 North American Standards Conformity

Vertiv™ Liebert® DCDactive Fan Module conforms to the following North American standards:

- CSA C22.2 No. 62368-1: Audio/Video, Information And Communication Technology Equipment - Part 1: Safety Requirements.
<https://ramuk.intertekconnect.com/WebClients/ITS/DLP/products.nsf/4c8700f3b75987a08525777700583333/224f6ab303ac90bf862583740066e1e3?OpenDocument>
- UL 62368-1:2014: Audio/Video, Information And Communication Technology Equipment - Part 1: Safety Requirements.
<https://ramuk.intertekconnect.com/WebClients/ITS/DLP/products.nsf/4c8700f3b75987a08525777700583333/c82158720a366709862583740066c8a8?OpenDocument>

This page intentionally left blank

2 Product Specifications

Table 2.1 Product Specifications

Mains Supply A, B		Single 110/230V Digit 19 = N, T	A/B 230V Digit 19 = A, B	A/B 110V Digit 19 = C, D
Operating voltage		95-264 V, 47-63Hz	190-264 V, 47-63 Hz	95-126 V, 47-63Hz
Rated current		11/5 A (110/230 V)	5 A	11 A
Fuse		12/10 A T (110/230 V)	10 A T	12 A T
External Temperature Sensors, Converter / Adapter for Door Contact and Leak				
Output voltage		5 V		
Output current		Max. 50 mA		
Communication type		OneWire		
Usable types		Liebert® SN-T KD UFN0001B - OneWire switching contact converter KD CEVV0111E + UTS0072B - distributor + temperature sleeve sensor		
Modbus TCP/IP Interface				
Communication type		IEEE 802.3		
Specification		See "DCDactive MODBUS TCP/IP Specification on page 61 "		
Mechanical Data		H2000 Digit 6 = A	H2200 Digit 6 = C	
Dimensions (L x W x H)	Liebert® DCD35	1954 x 420 x 125 mm (76.93 x 16.54 x 4.92 in)	2176 x 420 x 125 mm (85.67 x 16.54 x 4.92 in)	
	Liebert® DCD50	1954 x 579 x 125 mm (76.93 x 22.80 x 4.92 in)	2176 x 579 x 125 mm (85.67 x 22.80 x 4.92 in)	
Weight	Liebert® DCD35	35 kg (77.16 lb)		
	Liebert® DCD50	40 kg (88.18 lb)		
Protection class		IP20		
Degree of pollution		2		
Operating temperature		+10 to +40 °C (+50 to +104 °F)		
Storage temperature		-25 to +80°C (-13 to 176°F)		
Ambient humidity		0 to 95%, non-condensing		
Height above sea level		Max. 2000 m (6561.68 ft)		
Pressure Connection				
Working pressure		-250 to +250 Pa (-0.036 to 0.036 psi)		
Maximum allowed pressure		±1 bar (±14.5 psi)		
Tolerance		3% of the measurement value ± 0.2 Pa		
Working gases		Air, nitrogen		
Hose - outer diameter		6 mm (0.24 in)		

NOTE: Vertiv™ Liebert® DCD35 Active Fan Module is used for both the Liebert® DCD35 and Liebert® DCD47.

This page intentionally left blank

3 Vertiv™ Liebert® DCD and Vertiv™ Liebert® DCDactive Unit Code Table

Table 3.1 Liebert® DCD Model Number Example

MODEL NUMBER - PART 1/2										MODEL DETAILS											PART 2/2			
1	2	3	4	5	6	7	8	9	10	11	12	13	14	15	16	17	18	19	20	21	22	23	24	25
D	C	D	3	5	A	0	F	0	0	0	0	0	0	0	G	0	0	A	0	S	A			
D	C	D	4	7	A	0	F	0	0	0	0	0	0	0	G	0	0	A	0	S	A			
D	C	D	5	0	A	0	F	0	0	0	0	0	0	0	G	0	0	A	0	S	A			

Table 3.2 Vertiv™ Liebert® DCD Model Number Definition

Code	Definition
1-3	<p>Basic Unit</p> <p>Liebert® DCD is an air-water exchanger that is integrated into the rear door of a server cabinet. The heat exchanger serves to absorb heat loads from server cabinets of up to 35 and 50kW. Thereby, it can be configured in such a way that no thermal loads are released to the installation area.</p>
4-5	<p>Nominal Cooling Capacity</p> <p>35 = 35kW. 47 = 47kW (with DCDactive only). 50 = 50kW (cabinet width 800 mm only).</p>
6	<p>Cabinet Height</p> <p>A = For cabinet height of 2000 mm. C = For cabinet height of 2200 mm.</p>
7	<p>Cabinet Width</p> <p>0 = DCDactive Fan Unit (w/o cabinet). 6 = For cabinet width of 600 mm (not available for DCD 50). 8 = For cabinet width of 800 mm.</p>
8	<p>Cabinet Type</p> <p>3 = The DCD (passive) unit is equipped with adaptor for 3rd party cabinet. 0 = The DCD (passive) unit is delivered without cabinet and can be mounted on site on existing DCM cabinet. A = Unit will be shipped from factory installed on a DCM cabinet. (no DCDactive). B = DCD with DCM cabinet and DCDactive. F = DCDactive Fan Unit (retrofit or additional item for DCDs without cabinet).</p>
9	<p>CW Connection - Hinge Position</p> <p>0 = DCDactive Fan Unit only. 1 = Unit has chilled water connections from the top left side. 2 = Unit has chilled water connections from the top right side. 3 = Unit has chilled water connections from the bottom left side. 4 = Unit has chilled water connections from the bottom right side.</p>

Table 3.2 Vertiv™ Liebert® DCD Model Number Definition (continued)

Code	Definition
10	<p><u>Cabinet Depth</u></p> <p>O = No cabinet.</p> <p>E = The cabinet depth is 1000 mm.</p> <p>F = The cabinet depth is 1100 mm.</p> <p>G = The cabinet depth is 1200 mm.</p>
11	<p><u>Front Door</u></p> <p>O = No cabinet.</p> <p>C = with Single Sheet Steel Front-Door 83% perforation, hinged right hand side.</p> <p>G = with Double Sheet Steel Front-Door 83% perforation.</p> <p>L = with Single Sheet Steel Front-Door 83% perforation, hinged left hand side.</p> <p>X = Cabinet without front door.</p>
12	<p><u>19" Rails Front</u></p> <p>O = No cabinet.</p> <p>L = Asymmetric with air separation and additional vertical U slots (for width 800 mm only).</p> <p>A = Symmetric with air separation and additional vertical U slots (for width 800 mm only).</p> <p>B = Symmetric with air separation (for width 600 mm only).</p>
13	<p><u>19" Rails Rear</u></p> <p>O = No cabinet.</p> <p>Y = Asymmetric without air separation (for width 800 mm only).</p> <p>S = Symmetric without air separation.</p> <p>A = Symmetric with air separation and additional vertical U slots (for width 800 mm only).</p> <p>B = Symmetric with air separation (for width 600 mm only).</p> <p>L = Asymmetric with air separation and additional vertical U slots (for width 800 mm only).</p>
14	<p><u>Bottom Plate</u></p> <p>O = No cabinet.</p> <p>L = Cable entry for cabinets with levelling feet.</p> <p>R = Cable entry for cabinets with casters.</p>
15	<p><u>Rack Base</u></p> <p>O = No cabinet.</p> <p>A = with stationary rack base load rating 1000kg static height 100 mm (rack height + 100 mm).</p> <p>B = with stationary rack base load rating 1000kg static height 200 mm (rack height + 200 mm).</p> <p>R = with high load caster, load rating 1000kg mobile, 1500kg static on levelling feet, no rack base</p> <p>F = with leveling feet (0-25 mm), no rack base.</p>
16	<p><u>Color</u></p> <p>1 = Visible surface of covers RAL 7035 (light gray).</p> <p>G = Visible surface of covers RAL 7021 (dark gray).</p>

Table 3.2 Vertiv™ Liebert® DCD Model Number Definition (continued)

Code	Definition
17	<p>Side Panels</p> <p>O = No cabinet.</p> <p>X = Without side panels.</p> <p>B = with right + left side panel.</p>
18	<p>Jumpering Depth for Front 19" Rails</p> <p>O = No cabinet.</p> <p>A = jumpering space 80 mm, useful depth 740 mm.</p> <p>D = jumpering space 123 mm, useful depth 740 mm.</p>
19	<p>DCDactive Upgrades</p> <p>O = no DCDactive.</p> <p>N = Standard DCDactive incl. Modbus TCP/IP.</p> <p>T = DCDactive Modbus TCP/IP + monitoring (temp, leakage, door) + display.</p> <p>B = DCDactive with A/B transfer switch 230VAC incl. Modbus TCP/IP.</p> <p>A = DCDactive with A/B transfer switch 230VAC + Modbus TCP/IP + monitoring (temp, leakage, door) + display.</p> <p>D = DCDactive with A/B transfer switch 115VAC incl. Modbus TCP/IP.</p> <p>C = DCDactive with A/B transfer switch 115VAC + Modbus TCP/IP + monitoring (temp, leakage, door) + display.</p>
20	<p>Free</p> <p>O</p>
21	<p>Packaging</p> <p>P = DCD / DCDactive packed in cardboard box lying on pallet (max. 4 DCD units or 6 DCDactive); DCM cabinet / DCD / DCDactive combination upright on pallet, edge protection, dust cover.</p> <p>S = DCD / DCDactive packed in cardboard box lying on pallet (max. 4 DCD units or 6 DCDactive), wooden crate; DCM cabinet / DCD / DCDactive combination upright on pallet, edge protection, dust cover and wooden crate.</p>
22	<p>SFA</p> <p>A = No SFA .</p> <p>X = SFAs included.</p>
23-25	<p>Internal Counter</p>

The Vertiv™ Liebert® DCDactive Fan Module is configured within the unit code table of the Vertiv™ Liebert® DCD. The Liebert® DCDactive fan module can either be configured as a separate item or as a solution together with Rack and Liebert® DCD-passive heat exchanger. We recommend using the Vertiv configuration tools to configure the correct Liebert® DCDactive fan module. Please refer to your local Vertiv sales partner in case you don't have access to Vertiv configuration tools.

3.1 Component Locations

Figure 3.1 Vertiv™ Liebert® DCD Component Locations

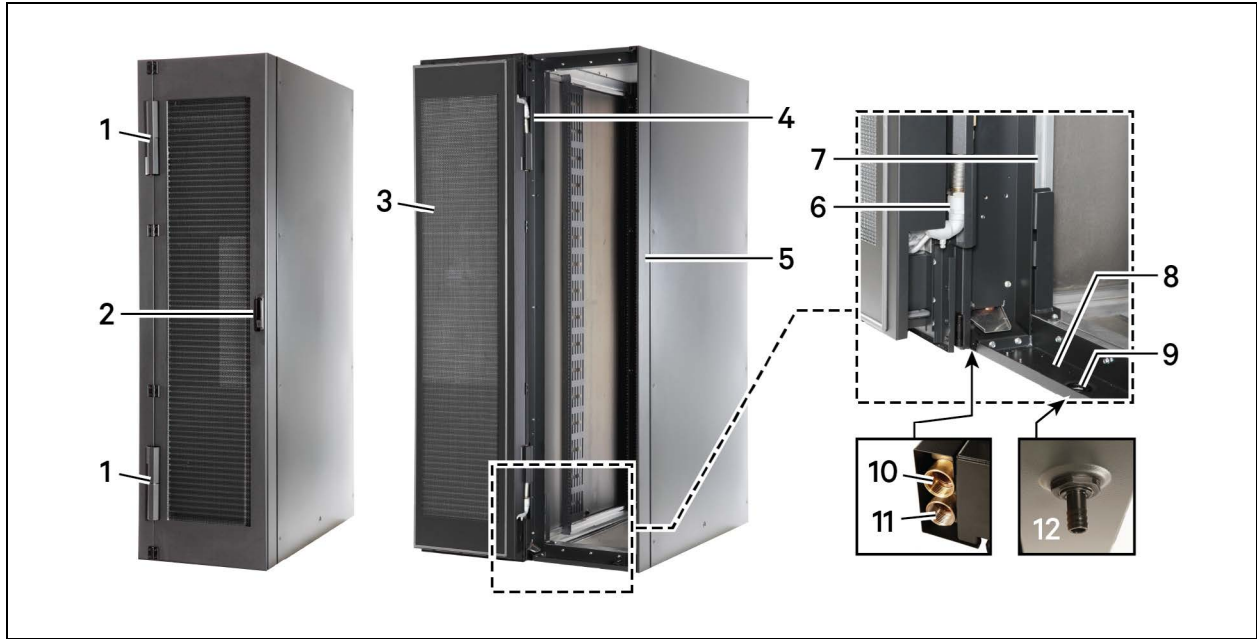

Item	Description
1	Upper and Lower swivel joints
2	Door handle
3	Door
4	Upper piping
5	DCD frame
6	Lower Piping
7	Aluminum profile
8	Condensate tray
9	Condensate drain plug
10	Chilled-water outlet
11	Chilled-water inlet
12	Condensate-hose adapter (on the bottom of the unit)

3.2 Layout of the Unit Components

Figure 3.2 Layout of the Unit Components

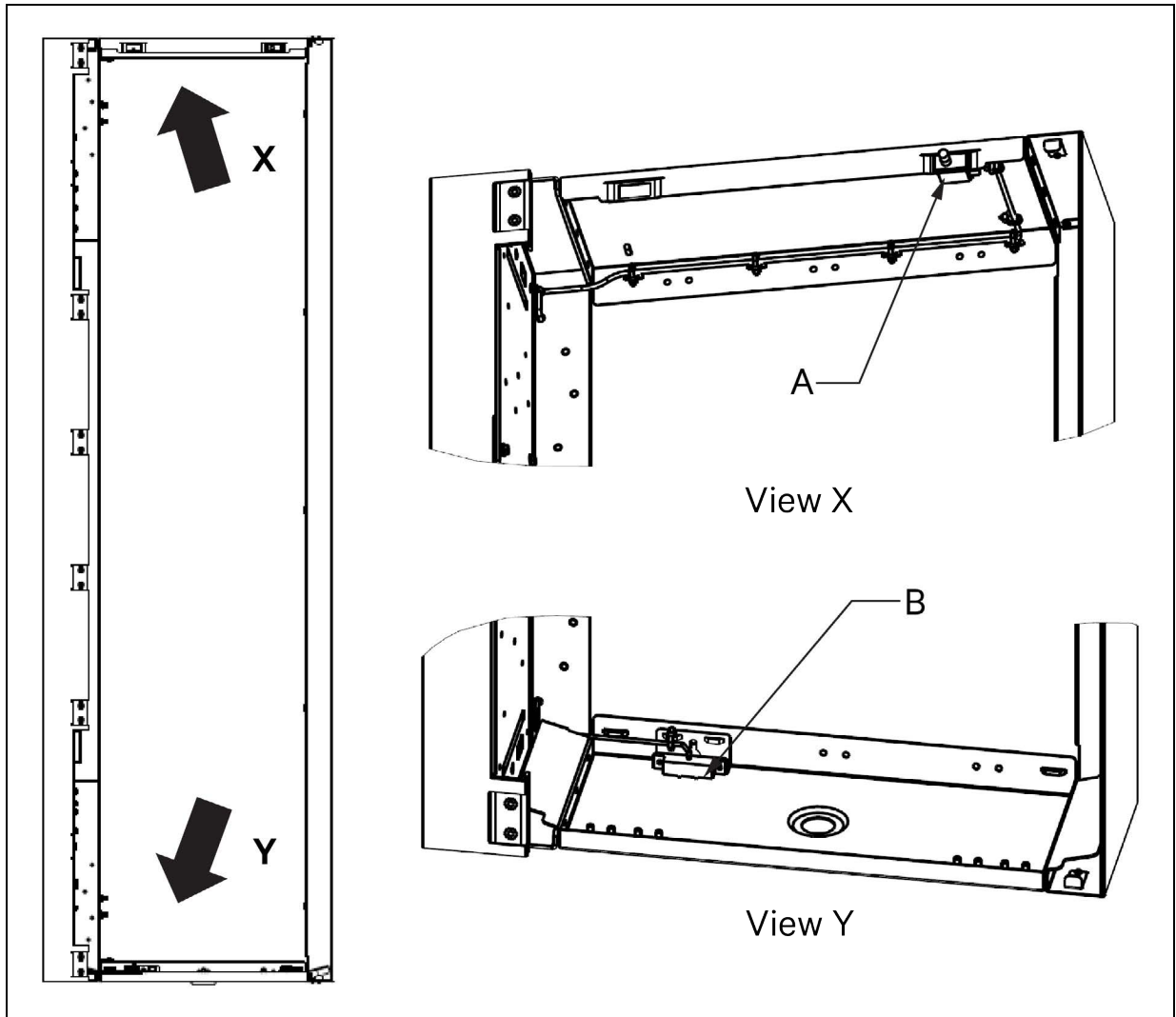

Item	Description
A	Part of door contact switch set: <ul style="list-style-type: none"> • KD item number: 166707 • VERTIV article number: 08.014.590.0 • Mounted on the opposite side of the hinge .
B	Part of leakage sensor set: <ul style="list-style-type: none"> • KD item number: 166708 • VERTIV article number: 08.014.591.0 • Mounted on the same side as the hinges .

This page intentionally left blank

4 Options and Accessories

4.1 Option Monitoring Package and Display

NOTE: For this option, please refer T, A, C of Digit 19- DCDactive Upgrades given in **Table 3.2** on page 11 .

When selecting one of these three options (T, A, C) for Digit 19, a color display and two temperature sensors (exhaust air) are built into the unit. Additional temperature sensors, a door contact switch and a leakage sensor are supplied to be installed inside the server rack. The scope of delivery includes additional unit that can be connected to the RJ45 port of the unit and mounted in the server cabinet. The units enable extended functions of the Vertiv™ Liebert® DCDactive. **Table 4.1** below lists the available units:

Table 4.1

Designation	Figure	Type	Scope of Delivery	Max. Connectable	Description
Temperature Sensor SN-T		SN-T	-	4	Temperature measurement in the server cabinet. Tolerance: ± 0.5 °C (0.9 °F)
Door Contact Switch 08.014.590.0		DS1D6CQ3	1	2	Detection of one or two open door(s). A maximum of 2 switches can be connected to one UFN0001B converter.
		UFN0001B	1	1	
Leak Sensor 08.014.591.0		GRI 2800	1	2	Detection of a water leak or condensate. A maximum of 2 leak sensors can be connected to one UFN0001B converter.
		UFN0001B	1	1	

4.2 Option A/B Transfer Switch



NOTE: For this option, please refer A, B, C, D of Digit 19- DCDactive Upgrades given in **Table 3.2** on page 11 .

This option allows the unit to be powered with two (2) independent power supplies. In case of a power failure the units will switch to the second supply. "A" supply is the preferred feed, "B" feed is only used if "A" feed is without power. In case "A" feed is powered back the "A" feed is used.

4.3 Accessories

NOTE: Accessories are not part of any version of the DCDactive units. They must be ordered separately. Depending on the option selected for the Vertiv™ Liebert® DCDactive, different uses are available for the accessories. Some accessories require certain DCDactive options. The **Table 4.2** below provides an overview of these accessories.

Table 4.2 Overview of Accessories

Designation	Figure	Type Code	Option Required	Possible Use According to Option
Standalone return temperature controller		08.009.166.0	Independent	Function independent of the Liebert® DCDactive. Adjustment by means of PC software via USB connection on the controller.
Liebert® DCDactive return temperature controller		08.009.167.0	All	Standard option Monitoring and setting of set-point and alarm values only via Modbus TCP/IP interface. TFT display, sensors option Additional monitoring and adjustment on the unit display.
Water temperature sensors flow, return	 	08.009.168.0	TFT display, sensors	TFT display, sensors option Teaching of sensors and monitoring on the unit display, via Modbus TCP/IP only monitoring of temperatures.

5 General Information

5.1 Intended Use

The Vertiv™ Liebert® DCD35/50 Active fan module may only be installed and operated on the server cabinet doors from the manufacturer for which it was designed (Vertiv™ Liebert® DCD). The server cabinet door represents the rear cover of the fan module.

The fan module is designed to use in controlled environments such as data centres or server rooms.

NOTE: The environmental conditions specified in the product specifications must be observed.

All materials required for installation and commissioning are included with the unit. The external fuses described in the product specifications and on the nameplate must be provided during installation.

NOTE: The different specifications for the different supply voltages must be observed.

5.2 Repair during Live Operation

In order to ensure high availability of the Liebert® DCD35/50 Active and thus of the entire server, it is possible to have certain repairs carried out by qualified personnel while the fan module is operating.



WARNING! Risk of electric shock. Can cause serious injury or death. Open all local and remote electric power supply disconnect switches and verify that power is off with a voltmeter before working within any electric connection enclosures. The Vertiv™ Liebert® controller does not isolate power from the unit, even in the "Unit Off" mode. Fan-motor controls can maintain an electric charge for 10 minutes after power is disconnected. Wait 10 minutes after power is verified as off before working within the electric control/ connection enclosures.

Installation, service, and maintenance work must be performed only by properly trained and qualified personnel and in accordance with applicable regulations and manufacturers' specifications. Opening or removing the covers to any equipment may expose personnel to lethal voltages within the unit even when it is apparently not operating and the input wiring is disconnected from the electrical source.



CAUTION: Risk of accidents and injuries.

There is a risk of injury due to electric shock and rapidly rotating parts. Repairs during live operation may only be carried out by qualified personnel with sufficient expertise, knowledge of the hazards and appropriate protective equipment.

5.3 Description of Functions

Following the correct installation and switch-on of the voltage supply, the fans start for around 5 seconds at 30% of their maximum speed. After that, normal operation starts. Depending on the equipment and settings of the unit, the fan speed is controlled depending on the differential pressure or the temperature in the server cabinet. Temperature-dependent control is only possible with units with the monitoring option (see [Monitoring Package with Display and Sensors](#) on the next page).

The differential pressure can be controlled in all equipment variants. The side port measures the ambient pressure and the top port measures the internal pressure of the server with the mounted pressure hose. The control system changes the speed of the fans so that the specified set-point differential pressure is achieved. In the standard system, the target differential pressure is 0 Pa. On units with a TFT display, the user can preselect the target differential pressure in levels in the TFT menu. These levels can be set in the Set-up TFT menu (password-protected). See [Menu of the TFT Display](#) on page 39 .

5.3.1 Standard Version

NOTE: For this option, please refer N of Digit 19- DCDactive Upgrades given in **Table 3.2** on page 11 .

A standard, Vertiv™ Liebert® DCD35/50 Active is equipped with a single wide-range voltage input (110/230V). There are no temperature sensors and no TFT display. A green operation LED and a red fault LED are installed for status monitoring.

All versions have a Modbus TCP/IP connection. This connection can be used to read measured values and the status of the machine and to change settings. The interface is specified in [MODBUS TCP/IP Specification](#) on page 61 .

All settings can be read and written using PC software via a USB port on the central control board.

5.3.2 Redundant A/B Power Supply

NOTE: For this option, please refer A, B, C, D of Digit 19- DCDactive Upgrades given in **Table 3.2** on page 11 .

With the optional A/B power supply (110 V or 230 V), the unit receives two separate mains supplies (Supply A and Supply B). As soon as mains voltage is applied to input A, the unit is supplied from this input. If the mains voltage at input A is removed, the unit switches internally to input B and is then supplied from input B. For 110 V and 230 V mains voltages, the correct unit variant must be ordered. (See [Vertiv™ Liebert® DCD and Vertiv™ Liebert® DCDactive Unit Code Table](#) on page 9).

5.3.3 Monitoring Package with Display and Sensors

NOTE: For this option, please refer A, C, T of Digit 19- DCDactive Upgrades given in **Table 3.2** on page 11 .

With the optional TFT display and sensors, the temperatures in the server cabinet (rack) and in the fan module (exhaust air temperature after the heat exchanger in the door) can be measured and displayed. The door contact switch can also be used to monitor the opening and closing of the rack doors. A leak sensor can be connected to detect leaks or excessive condensate. With the color TFT display, the set and actual speeds of the fans can be read off and the status of the unit can be monitored. Many other functions are also possible. See **Table 5.1** on the facing page .

Table 5.1 Different Possible Functions of Monitoring Package

Function	Description
Selection of the reference variable for speed control	Choice between differential pressure control and server temperature control.
Selection of the pressure level for differential pressure control	Selection between three set differential pressures: <ul style="list-style-type: none"> • Slight Negative Pressure • Neutral • Slight Positive Pressure.
Setting the pressure levels	In the password-protected Set-up menu: <ul style="list-style-type: none"> • Setting of the three pressure levels between -15 Pa and +15 Pa.
Setting of the server temperature control	<ul style="list-style-type: none"> • Setting of the start temperature (minimum speed) and end temperature (maximum speed). • Linear speed control between the start and end temperature. • Selection between the average and maximum value of the sensors in the server cabinet.
Setting of the speed limits	<ul style="list-style-type: none"> • Setting of the lower and upper speed limit between 17% and 100%.

Table 5.1 Different Possible Functions of Monitoring Package (continued)

Function	Description
	<ul style="list-style-type: none"> Fixed speed possible independent of the control if the upper speed limit is set lower than the lower speed.
Setting of the temperature alarms	Setting of the lower and upper temperature alarm threshold independently for: <ul style="list-style-type: none"> Server Temperature Exhaust Air Temperature Water Temperature of the Optional Return Temperature Controller. An alarm is displayed if the value is exceeded or fallen below.
Temperature display in °C / °F	Setting the unit of all temperatures.
Connection of a door contact switch	The UFN0001B OneWire switching contact converter can be programmed as a door contact switch. Up to two switches can be connected to the switching contact converter. When the door is open, the fans are switched off and an alarm is displayed.
Connection of a leak sensor	The UFN0001B OneWire switching contact converter can be programmed as a leak sensor. Up to two leak sensors can be connected to the switching contact converter. An alarm is displayed if a leak occurs. The behaviour of the optional return temperature controller in the event of a leak can be selected on the TFT: <ul style="list-style-type: none"> Close Neutral Open.
Service shutdown	<ul style="list-style-type: none"> Manual shutdown of the fans on the TFT for service. Automatic restart after 60 min with display of remaining time.
Modbus TCP/IP interface	<ul style="list-style-type: none"> Reading of all states, measured values, alarms and settings. Writing of settings.
Accessories Flow modulating valve	<ul style="list-style-type: none"> Display of the measured water temperature and valve position. Setting the setpoint value of the heat exchanger return temperature (Vertiv™ Liebert® DCD). Control of the return temperature. Monitoring of alarm thresholds (see Setting of temperature alarms).
Accessories Water temperature sensors for flow and return	Display of water temperatures for supply and return of the heat exchanger.

5.3.4 Self-Diagnosis and Messages

The Vertiv™ Liebert® DCDactive constantly monitors the function of its components and reports errors to the user. Different paths are provided for signalling. Furthermore, the monitoring option allows users to define their own alarms, such as temperature alarms, leak alarms and door alarms.

Table 5.2 Self-Diagnosis and Messages

	Signalling	Description
Reporting System	TFT Display: <ul style="list-style-type: none"> • Flashing warning triangle. • Plain text in message menu with message memory. • Modbus TCP/IP interface. • Messages and message memory can be retrieved. 	If an error is detected or an alarm condition occurs, the information is provided and stored in the message memory. The exception is the door alarm. It is not saved so as not to overwrite relevant messages in the memory.
Signalling Contact (Red LED)	Signalling contact closed Red LED lights up	Without the monitoring option, an error is only visible through the red LED on the unit. Alarms cannot be used. The signalling contact and red LED work synchronously.

The various errors and alarms have different message times and effects on the system. The display of a message on the TFT can be delayed up to 5s.

Table 5.3 Alarms on TFT Display

Error, Alarm	Signalling Contact	Delay Time [s]	Effect
Pressure sensor error	x	3	If differential pressure control is active: Speed to maximum.
Fan error	x	10	-
Temperature sensor error	x	60	If temperature control is active and no sensor can be read: Speed to maximum.
Return temperature controller error	x	10	The Liebert® DCDactive cannot take any action because communication with the unit is no longer possible if this error occurs. The controller itself ensures that the valve opens in the event of malfunctions or a power failure (emergency operation).
Door contact switch error	x	60	Only one communication error to the UFN0001 OneWire adapter can be detected. The correct function of the actual switch cannot be checked.
Leak sensor error	x	60	Only one communication error to the UFN0001 OneWire adapter can be detected. The correct function of the actual leak sensor cannot be checked.
Leak detected alarm	-	10	Depending on the setting for the optional return temperature controller: close / neutral / open.
Door open alarm	-	2	Fans off, valve of the optional return temperature controller closed. TFT main screen shows open door.
Temperature exceeded or fallen below alarm	-	10	-

6 Installation and Commissioning



WARNING! Arc flash and electric shock hazard. Can cause serious injury or death. Building and equipment damage may also result. Disconnect all local and remote electric power supplies and wear appropriate, OSHA-approved personal protective equipment (PPE) per NFPA 70E before working within the electric control enclosure. Customer must provide earth ground to unit, per NEC, CEC and local codes, as applicable. Verify with a voltmeter that power is Off. The Vertiv™ Liebert® controller does not isolate power from the unit, even in the “Unit Off” mode. Some internal components still require and receive power even during the “Unit Off” mode of the controller. The factory-supplied, optional disconnect switch is inside the unit. The line side of this switch contains live high voltage. The only way to ensure that there is NO voltage inside the unit is to install and open a remote disconnect switch. Refer to unit electrical schematic. Before proceeding with installation, read all instructions, verify that all the parts are included and check the nameplate to be sure the voltage matches available utility power. Follow all local codes.



WARNING! Risk of electric shock. Can cause serious injury or death. Building and equipment damage may also result. Open all local and remote electric power supply disconnect switches and verify that power is off with a voltmeter before working within any electric connection enclosures. The Liebert® controller does not isolate power from the unit, even in the "Unit Off" mode. Some internal components require and receive power even during the "unit off" mode of the Liebert® controller. Installation, service, and maintenance work must be performed only by properly trained and qualified personnel and in accordance with applicable regulations and manufacturers' specifications. Opening or removing the covers to any equipment may expose personnel to lethal voltages within the unit even when it is apparently not operating and the input wiring is disconnected from the electrical source.



WARNING! Risk of short circuits and electric shock. Can cause serious injury or death. Building and equipment damage can result from cut insulation or damaged wires. Can cause overheated wiring, smoke, fire, activation of fire suppression systems and EMS personnel, and loss of power to fans. Verify that all wiring connections are tight and that all wiring is contained within the junction box prior to closing and securing the cover. Insert CSA-certified or UL-listed bushings into holes and/or knockouts used to route wiring through metal panels to protect the wire insulation from contact with sheet metal edges.



WARNING! Risk of improper wire sizing/ rating and loose electrical connections causing overheated wire and electrical connection terminals resulting in smoke or fire. Can cause serious injury or death. Building and equipment damage may also result. Use correctly sized copper wire only and verify that all electrical connections are tight before turning power On. Check all electrical connections periodically and tighten as necessary.



WARNING! Risk of improper wiring, piping, moving, lifting and handling. Can cause serious injury or death. Building and equipment damage may also result. Installation and service of this equipment should be done only by qualified personnel who have been specially-trained in the installation of air-conditioning equipment and who are wearing appropriate, OSHA-approved PPE.



CAUTION: Risk of contact with sharp edges, splinters and exposed fasteners. Can cause injury. Only properly trained and qualified personnel wearing appropriate, OSHA-approved PPE should attempt to move, lift, remove packaging from or prepare the unit for installation.

NOTICE

Risk of improper power-supply connection. Can cause equipment damage and loss of warranty coverage.

Prior to connecting any equipment to a main or alternate power source (for example back-up generator systems) for start-up, commissioning, testing, or normal operation, ensure that these sources are correctly adjusted to the nameplate voltage and frequency of all equipment to be connected. In general, power-source voltages should be stabilized and regulated to within +/- 10% of the load nameplate nominal voltage.

See transformer label for primary tap connections. Installer will need to change transformer primary taps if applied unit voltage is other than pre-wired tap voltage.

NOTICE

Risk of a catastrophic water circuit rupture. Can cause expensive building and equipment damage.

Install an overflow drain pan under the unit with a monitored leak detection system in the pan and shutoff valves in the supply and return water lines that automatically close if water is detected by the leak detection system. The shutoff valves should be spring return and must be rated for a close-off pressure that is the same as or higher than the supply water pressure. If it is not possible to install an overflow drain pan, then a monitored leak detection system should be installed in the base of the unit or under the unit to actuate the shutoff valves immediately on a leak detection signal.

The overflow drain pan should have a drain line connected to it that flows to a floor drain or maintenance sink in case of a shutoff valve or leak detection system malfunction.

NOTE: Installation must be carried out in a voltage-free state. The mains feed (Supply A and B) must be disconnected or all terminals disconnected.



CAUTION: Risk of improper piping installation, leak checking, fluid chemistry and fluid maintenance. Can cause injury. Building and equipment damage may also result. Installation and service of this equipment should be done only by qualified personnel who have been specially-trained in the installation of air-conditioning equipment and who are wearing appropriate, OSHA-approved PPE.

NOTICE

Risk of piping-system corrosion and freezing fluids. Can cause leaks resulting in equipment and very expensive building damage. Heat exchangers and piping systems are at high risk of freezing and premature corrosion. Fluids in these systems must contain the proper antifreeze and inhibitors to prevent freezing and premature coil and piping corrosion. When the cooling unit or piping may be exposed to freezing temperatures, charge the system with coolant fluid based on the coldest ambient design temperature. Automotive antifreeze is unacceptable and must NOT be used in any fluid system. Use only coolant fluid solution that meets the requirements of recommended industry practices. Do not use galvanized pipe.

The system coolant fluid must be analyzed by a competent fluid-treatment specialist before start up to establish the inhibitor and antifreeze solution requirement and evaluated at regularly scheduled intervals throughout the life of the system to determine the pattern of inhibitor depletion.

The fluid complexity and variants of required treatment programs make it extremely important to obtain the advice of a competent and experienced fluid-treatment specialist and follow a regularly scheduled coolant-fluid system-maintenance program.

Fluid chemistry varies greatly as do the required additives, called inhibitors, that reduce the corrosive effect of the fluids on the piping systems and components.

The chemistry of the coolant fluid used must be considered, because some sources may contain corrosive elements that reduce the effectiveness of the inhibited formulation. Sediment deposits prevent the formation of a protective oxide layer on the inside of the coolant system components and piping. The coolant fluid must be treated and circulating through the system continuously to prevent the buildup of deposits and/or growth of sulfate reducing bacteria. Proper inhibitor maintenance must be performed to prevent corrosion of the system.

Consult fluid manufacturer for testing and maintenance of inhibitors.

Commercial-grade coolant fluid is generally less corrosive to the common metals of construction than water itself. It will, however, assume the corrosivity of the coolant fluid from which it is prepared and may become increasingly corrosive with use if not properly inhibited.

Vertiv recommends installing a monitored fluid-detection system that is wired to activate the automatic-closure of field-installed coolant-fluid supply and return shut-off valves to reduce the amount of coolant-fluid leakage and consequential equipment and building damage. The shut-off valves must be sized to close-off against the maximum coolant-fluid system pressure in case of a catastrophic fluid leak.

NOTICE

Risk of no-flow condition. Can cause equipment damage. Do not leave the water/coolant fluid-supply circuit in a no-flow condition. Idle fluid allows the collection of sediment that prevents the formation of a protective oxide layer on the inside of the tubes. Keep unit switched On and water/ coolant fluid-supply circuit system operating continuously. In multiple unit teams, allow standby units to enter the rotation automatically or schedule regular manual rotations.

NOTICE

Risk of leaking chilled water lines. Can cause equipment and building damage.

Lines and joints must be inspected regularly. Improper installation, application and service practices can result in water leakage from the unit. Water leakage can result in severe property damage and loss of critical data center equipment. Do not locate unit directly above any equipment that could sustain water damage.

Vertiv recommends installing monitored leak detection equipment for the unit and supply and return lines.

6.1 Installation

When mounting the fan module on the server door, the installation instructions of the Vertiv™ Liebert® DCD must be observed. The cover of the Vertiv™ Liebert® DCD35/50 Active must be removed before installation. See **Figure 6.1** below . The PE cable (protective earth cable) can be removed from the PE bolt. See **Figure 6.2** on the facing page . Before reattaching the cover, the PE cable must be plugged back onto the PE bolt.

Before the Liebert® DCDactive fan module is mechanically mounted to the cabinet, the direction of rotation of the door handle must be changed. This is necessary that the handle does not hit the fan module. The conversion is carried out with the Liebert® DCD door open. The following assembly steps are necessary:

Figure 6.1 Assembly of the Handle System

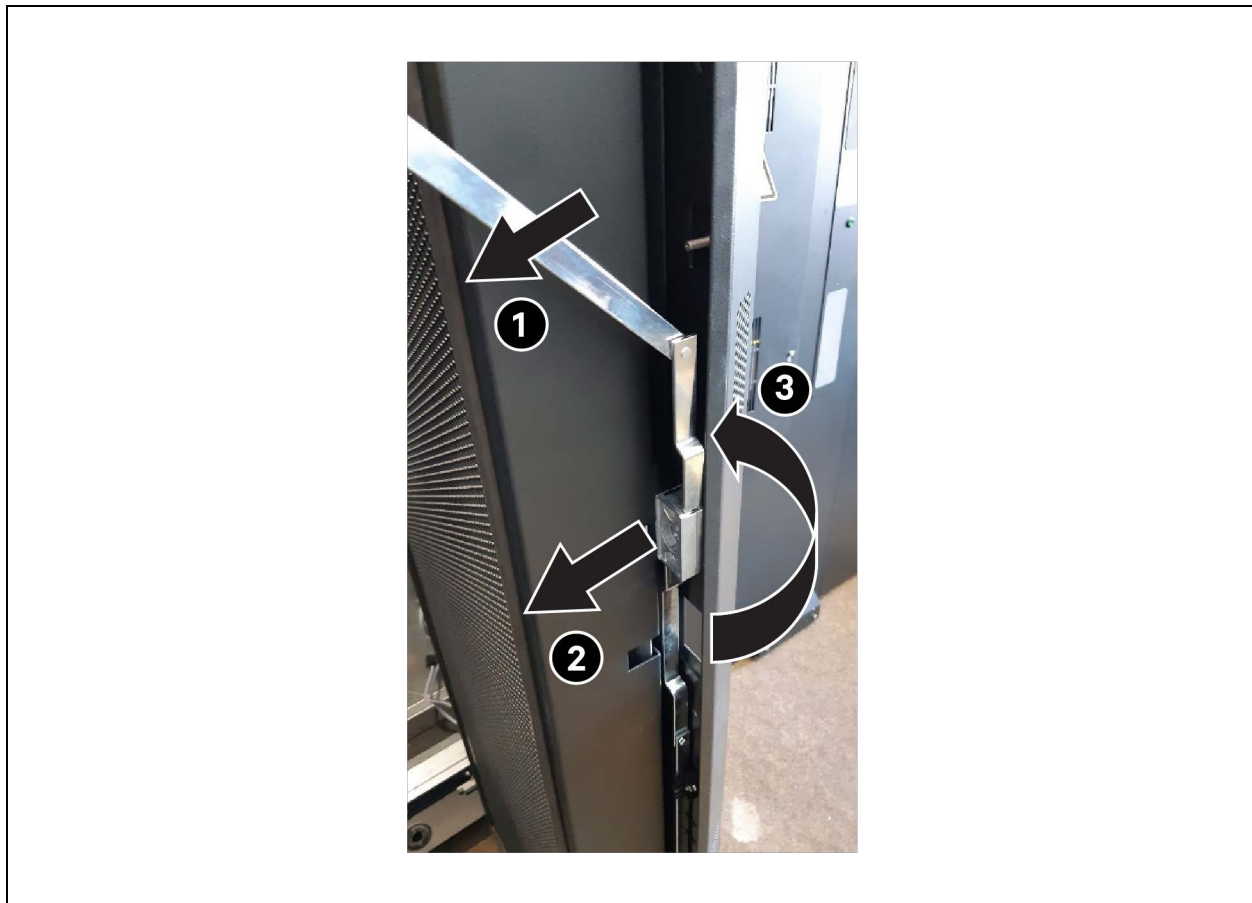

1. Remove the *upper rod* of the latch system.
2. Remove the *centre screw* that fits the handle and the 2 screws that hold the handle frame.
3. Rotate the *rod drive*.

Figure 6.2 Assembly of the Handle System

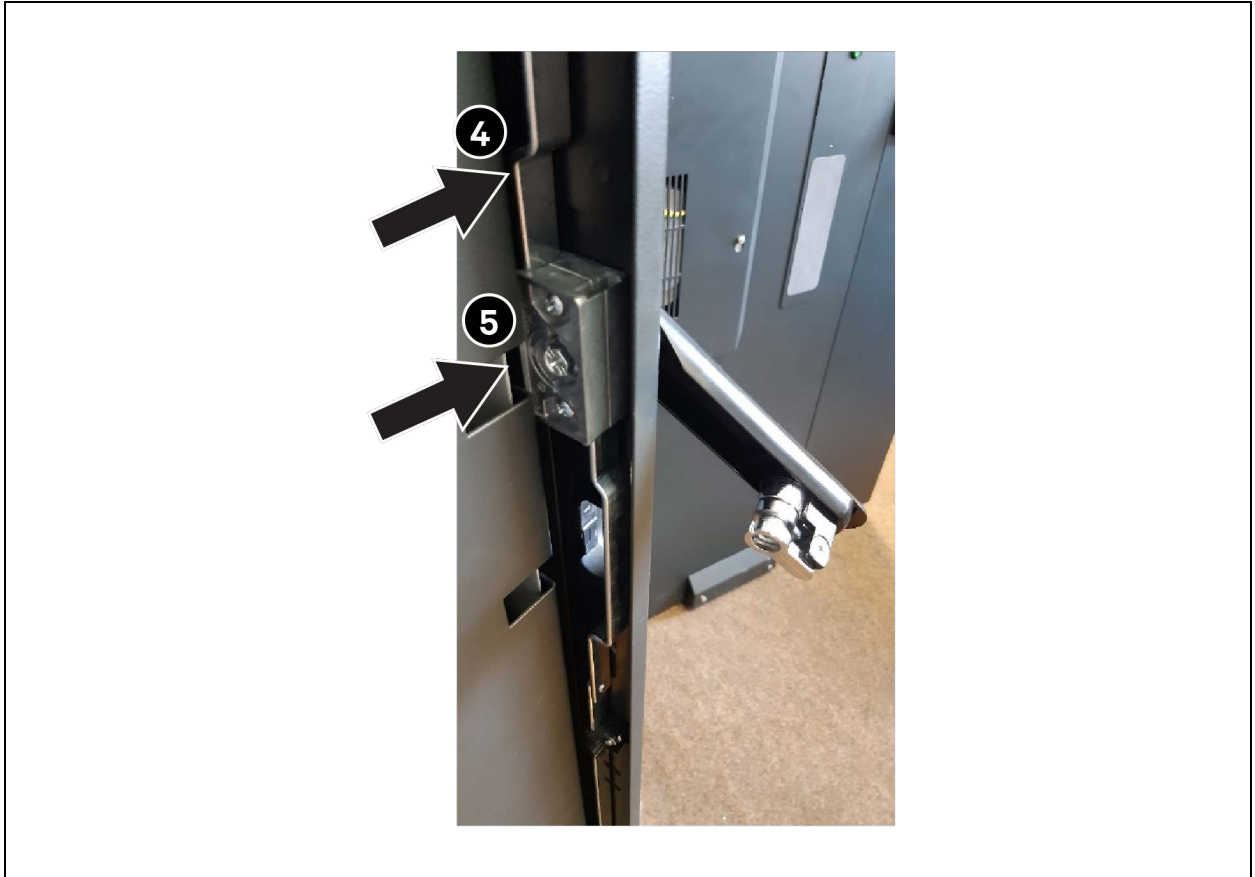

4. Install the *upper rod* of the latch system.
5. Fix the *handle frame* and the *handle*.

Figure 6.3 Removing Vertiv™ Liebert® DCD35/50 Active Cover

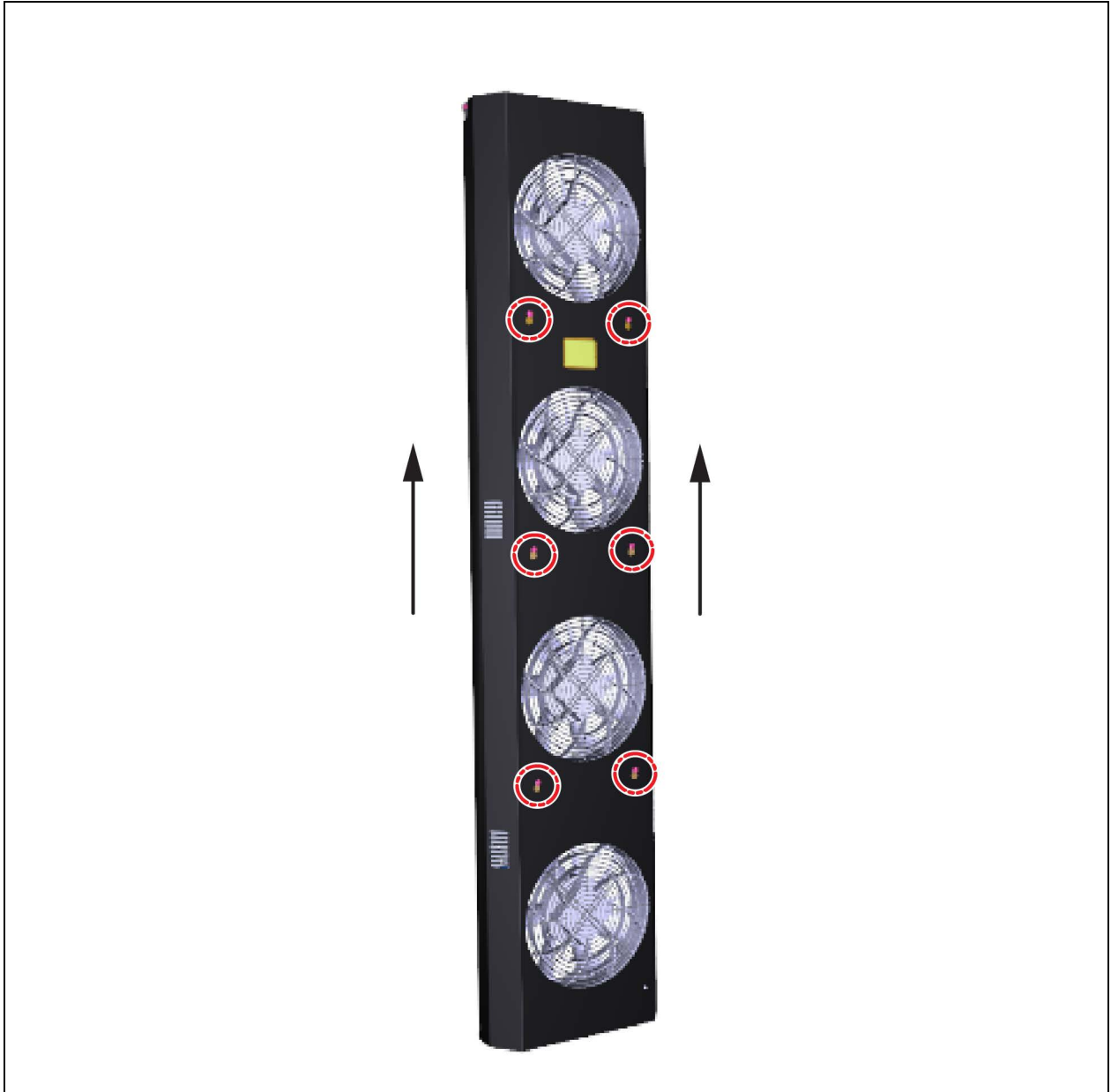

Figure 6.4 PE Connection



1. To mount the Vertiv™ Liebert® DCD35/50 Active on the server door, loosen the screws of the lower bracket (Do not remove!) and pull out the bracket downwards until it stops.
2. The fan module can then be hung on the Vertiv™ Liebert® DCD with the upper bracket.
3. To fix it in place, the lower holder must be pushed back in and the screws tightened (tightening torque 5 Nm). **Figure 6.5** on the next page shows the intended attachment options for mounting on the server door.

Figure 6.5 Upper and Lower Brackets of the Vertiv™ Liebert® DCD35 Active

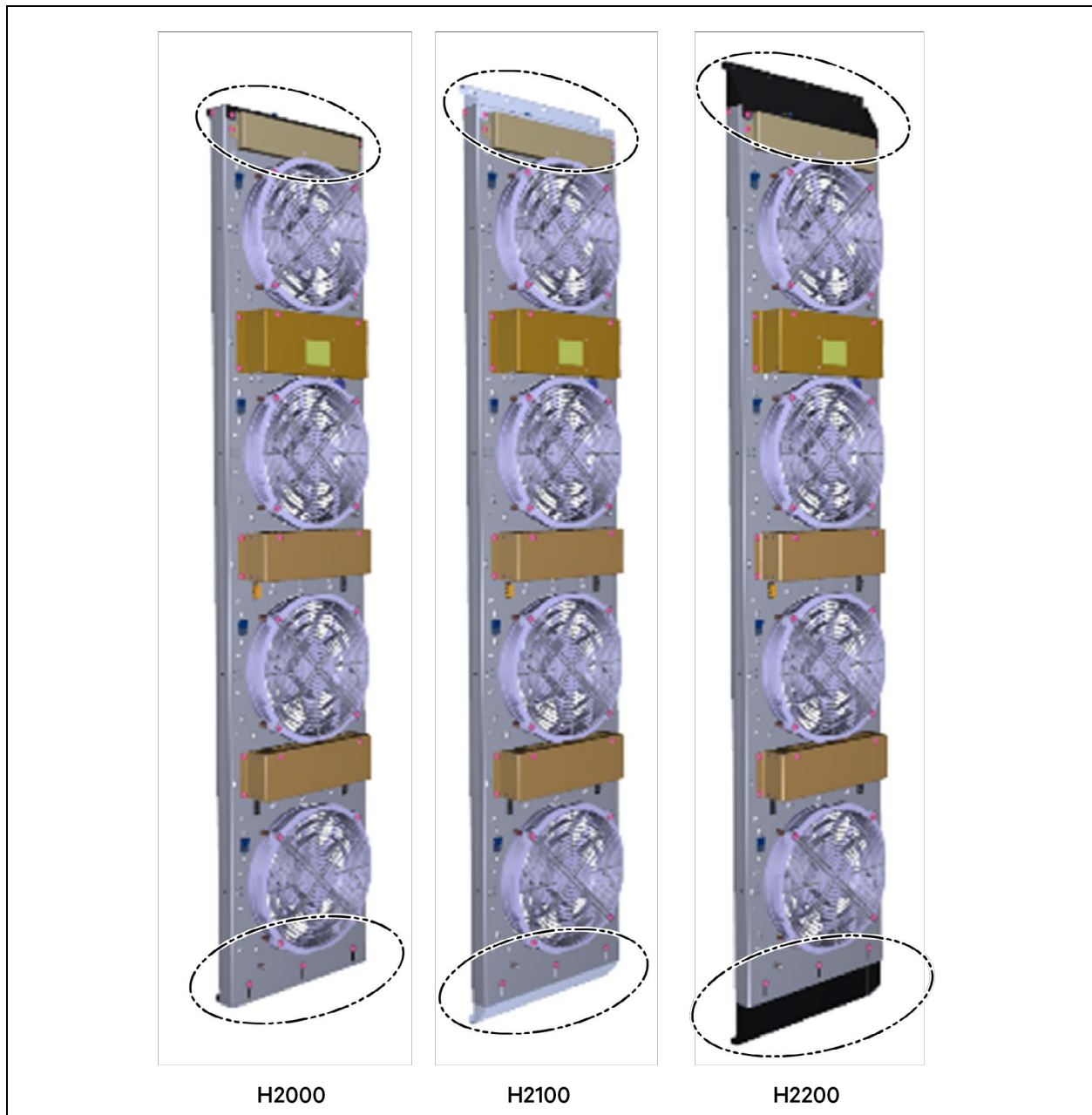

Figure 6.5 above shows upper and lower brackets of the Liebert® DCD35 Active for attachment onto the Vertiv™ Liebert® DCD (H2000, H2100, H2200).

4. Refit the cover once the assembly is attached to the Heat Exchanger Door. Make sure that the PE cable of the cover is connected to the unit.
5. Fix back the cover using six(6) screws. Torque required to tighten the screws is 5Nm. See **Figure 6.5** above .

Figure 6.6 Upper and Lower Brackets of the Vertiv™ Liebert® DCD50 Active

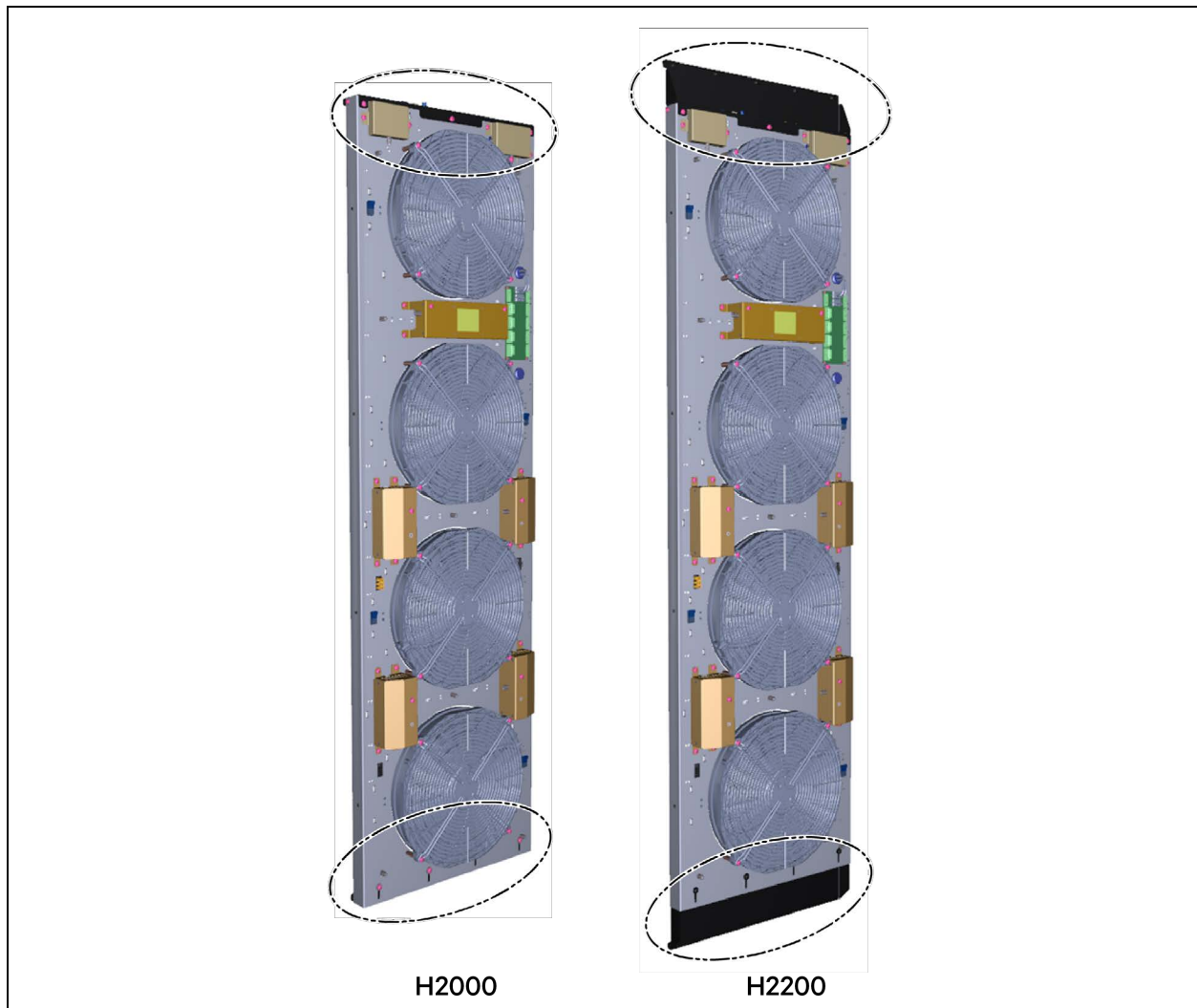
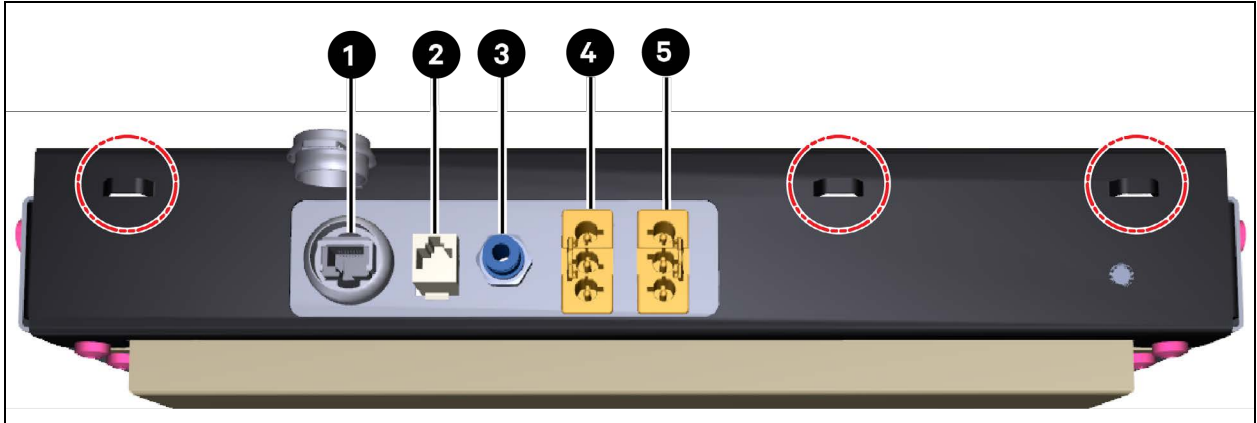

Figure 6.6 above upper and lower brackets of the Liebert® DCD50 Active for attachment onto the Vertiv™ Liebert® DCD (H2000, H2200).

6. The supply lines and the pressure hose must be connected to the cable bridges and secured (**Figure 6.7** on the next page or **Figure 6.9** on page 31).
7. The pressure hose is connected to the upper pressure connection, which is then led into the server interior and secured there (see **Figure 6.10** on page 31).
8. The lateral pressure connector is left open and measures ambient pressure. It must not be closed off.
9. No neighboring units are allowed to blow into the connection or otherwise influence the ambient pressure measurement.
10. Sensors placed inside the server can be connected to the RJ45 socket as an option.
11. Sensors connected for the first time must be taught during commissioning (see **Figure 6.6** above).
12. The optional return temperature controller is also connected to the RJ45 connector.

Figure 6.7 Connections and Cable Fixing Points on the Vertiv™ Liebert® DCD35 Active (H2000)



Item	Description
1	Modbus TCP/IP Interface
2	RJ45, Sensors Return Temperature Controller
3	Pressure connection Inside server
4	Supply A
5	Supply B

Figure 6.8 Connections and Cable Fixing Points on the Vertiv™ Liebert® DCD50 Active (H2000)

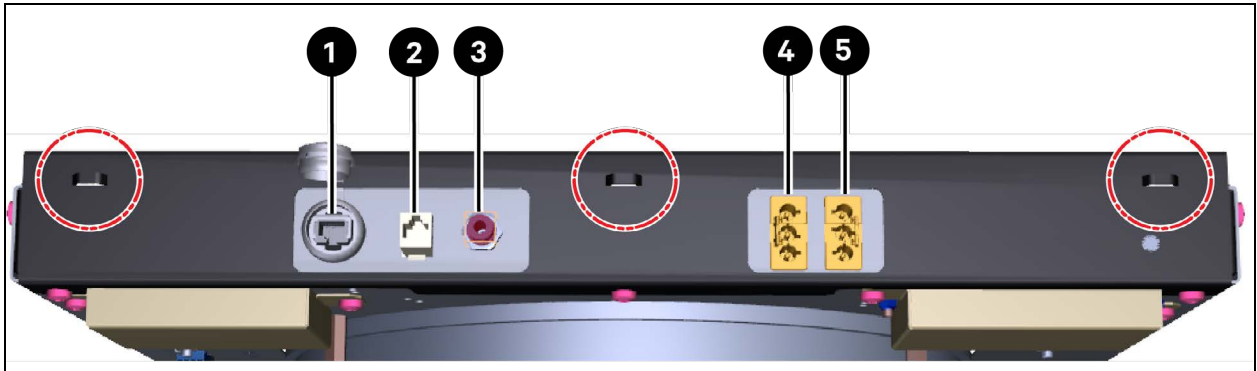

Item	Description
1	Modbus TCP/IP Interface
2	RJ45, Return Temperature Controller Sensors
3	Pressure connection Inside server
4	Supply A
5	Supply B

Figure 6.9 Cable Fixing Points on the Vertiv™ Liebert® DCD35/Vertiv™ Liebert® DCD50 Active (H2200)

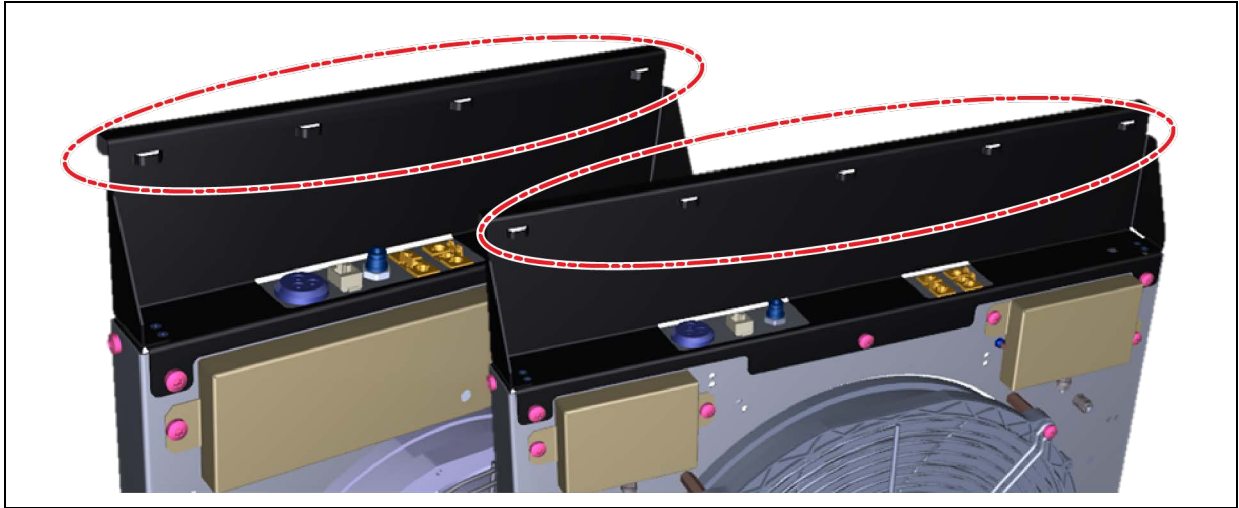
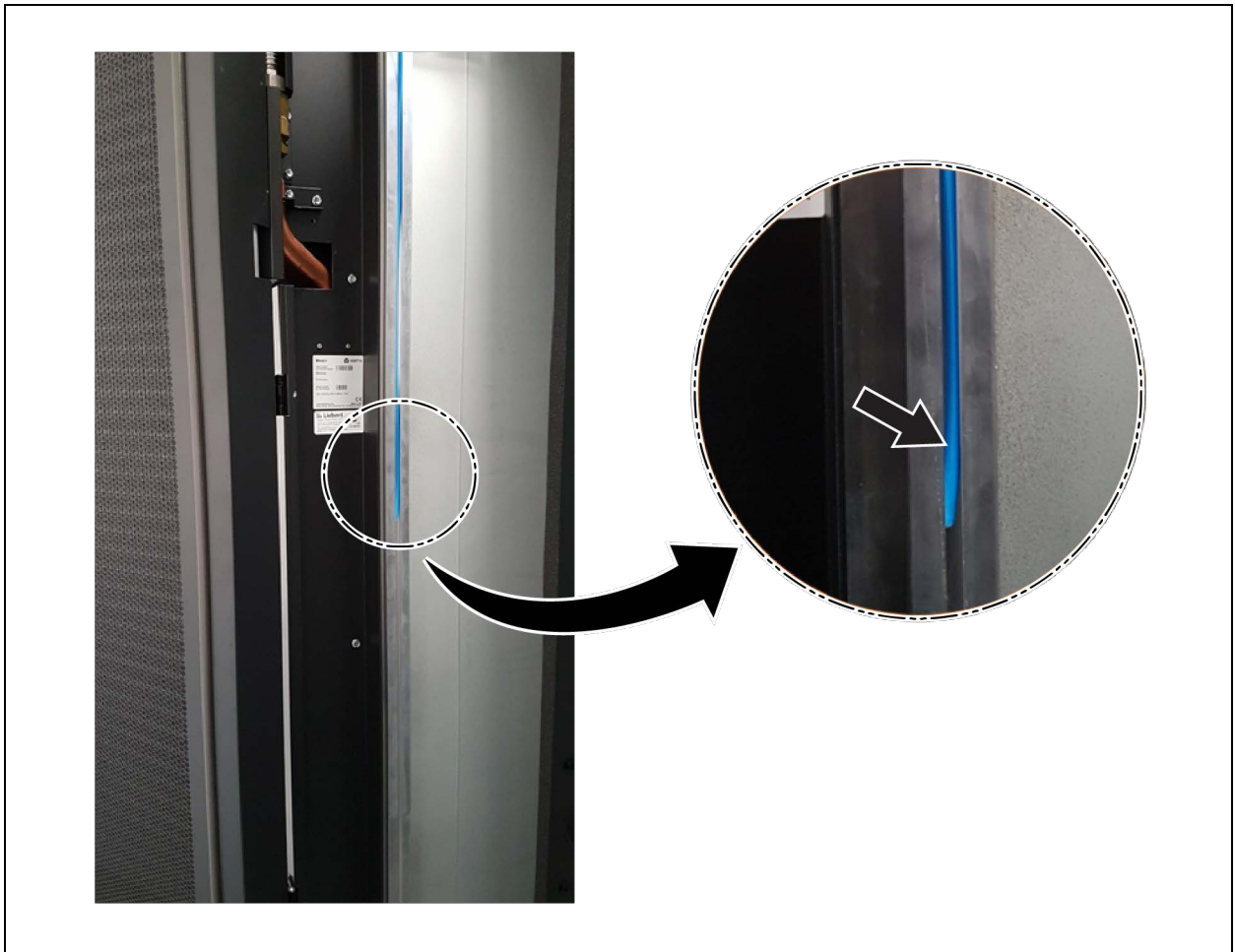

Figure 6.10 Laying the Pressure Hose in the T-slot or Perpendicular to Direction of Airflow in the Server Cabinet





WARNING! Risk of electric shock. Can cause serious injury or death. Building and equipment damage may also result. Open all local and remote electric power supply disconnect switches and verify that power is off with a voltmeter before working within any electric connection enclosures. The Vertiv™ Liebert® controller does not isolate power from the unit, even in the "Unit Off" mode. Some internal components require and receive power even during the "unit off" mode of the Liebert® controller.

Installation, service, and maintenance work must be performed only by properly trained and qualified personnel and in accordance with applicable regulations and manufacturers' specifications. Opening or removing the covers to any equipment may expose personnel to lethal voltages within the unit even when it is apparently not operating and the input wiring is disconnected from the electrical source.

NOTE: The PE contacts of the Supply A and B connections must be connected to the electrical system's PE (protective earth).

NOTICE

Before switching on the supply voltage, the prescribed tests must be carried out in accordance with the local safety regulations.

After the fan module has been installed and all connections have been made, the supply voltage can be switched on. The unit starts up immediately and after a short time starts to regulate itself. The green operation LED (standard) lights up or the TFT display (optional) starts with the splash screen and shortly afterwards jumps to the main screen.

6.2 Optional Connection of the General Alarm

NOTE: This work may only be carried out by qualified personnel with sufficient expertise, knowledge of the hazards and appropriate protective equipment.

The work described here means a change to the unit. The installer must ensure that the extension does not compromise the safety of the unit. All technical specifications and instructions must be followed.

A potential-free normally closed contact is provided on the central controller of the Vertiv™ Liebert® DCD35/50. This is used for error messages to higher-level systems. It opens if there is an error (analogous to the red LED) and is closed if there is no error (analogous to the green LED). In the de-energised state, the contact is open.

Table 6.1 Technical Characteristics of the Signaling Contact

Parameters	Description
Max. voltage / current	30 VDC / 0.5 A (external fuse).
Terminal properties	0.5 mm ² - 1.0 mm ² , rigid or flexible with ferrule.

Table 6.2 Cable Characteristics (Not included in Scope of Delivery)

Parameters	Description
Type	Single core or sheathed cable, 0.5 mm ² - 1.0 mm ² .
Approvals	Depending on the location: H05V-K / IEC60228 / VDE0295 / UL758 / CSA C22.2.
Wire Gage Size	20 awg to 17 awg.

The signalling cable must be connected to terminals X4.NO1 and X4.C12 on the central controller (see **Figure 6.11** on the facing page).

The cables must be laid as shown in **Figure 6.12** on page 34 . They must be fixed to the housing with cable ties so that they cannot reach the fans or areas with parts carrying mains voltage.

The cable can be led out through the cable grommet on the top of the Vertiv™ Liebert® DCD. The cable must be fixed to the housing with cable ties.

Figure 6.11 Central Controller, Alarm Connections

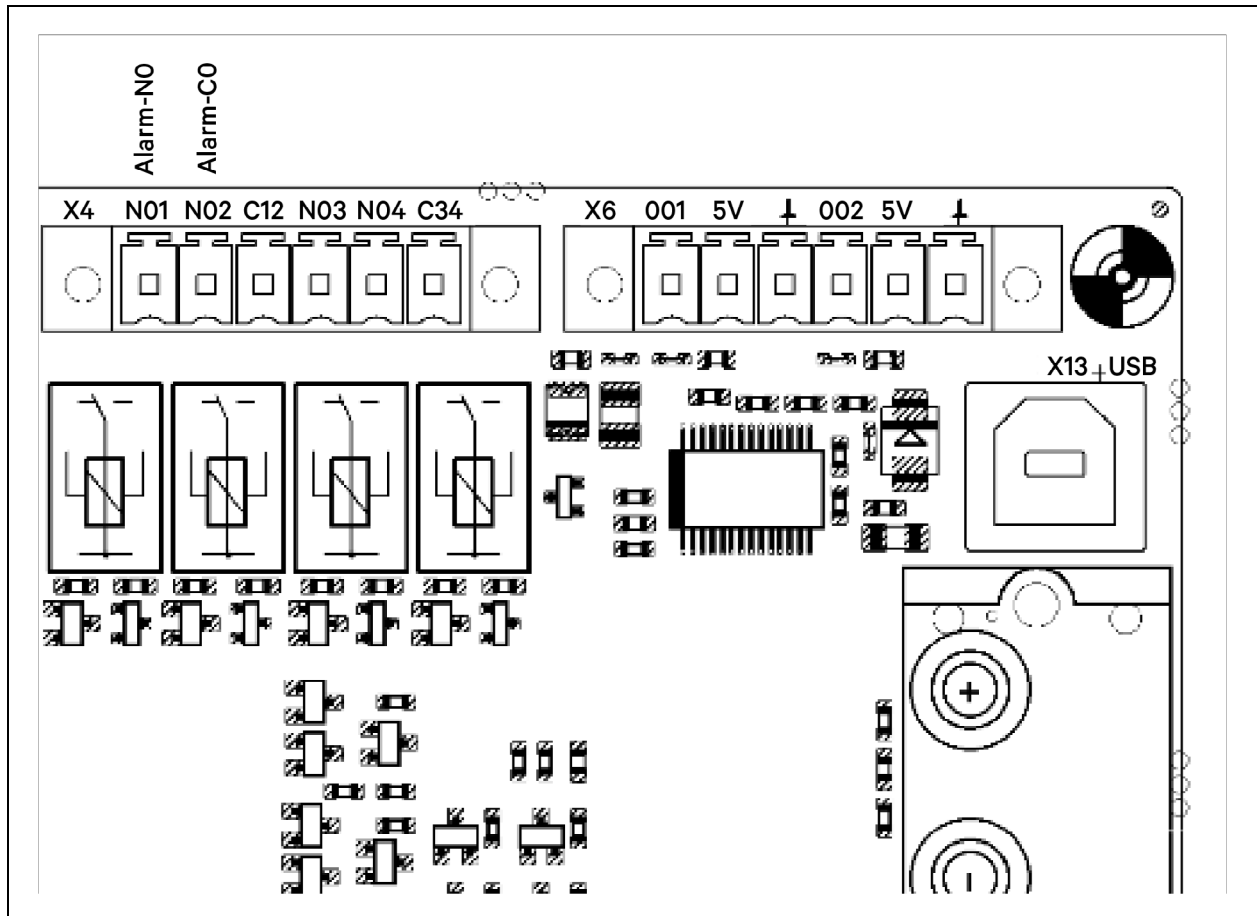
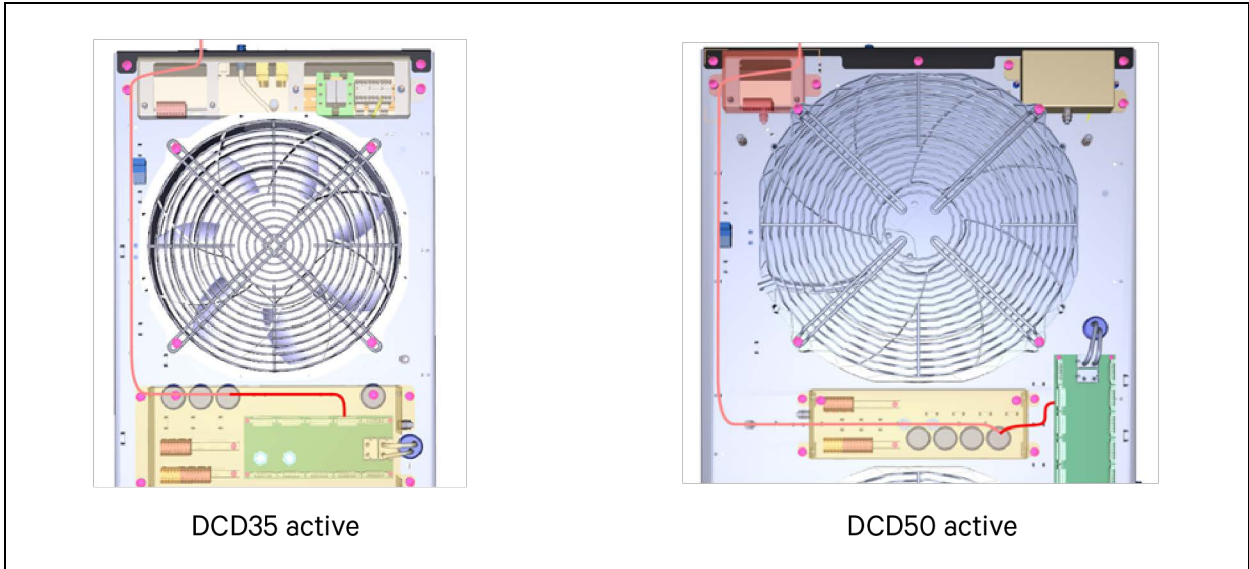

Figure 6.12 Alarm Cable Routing, Red - Top Side, Pink - Bottom Side of the Base Housing, Feed through Cable Grommet



6.3 Optional Connection of the OneWire Sensor Adapter

In case the Vertiv™ Liebert® DCD is supplied with the monitoring package (Liebert® DCActive type “T”, “A” and “C” additional temperature sensors, a door contact switch and a leak detector) are supplied. These optional items can be connected to a bus using a one wire adapter. The adapters are included to the monitoring package.

The UFN0001 OneWire adapter has two RJ45 connectors for connection to the Liebert® DCActive or for looping the bus through to other units. Two terminals with 2 poles each are available for connecting the door contacts or leak sensors. To use them, the units must be taught as described in [Teaching Sensors](#) on page 56 .

Figure 6.13 UFN0001 OneWire Adapter

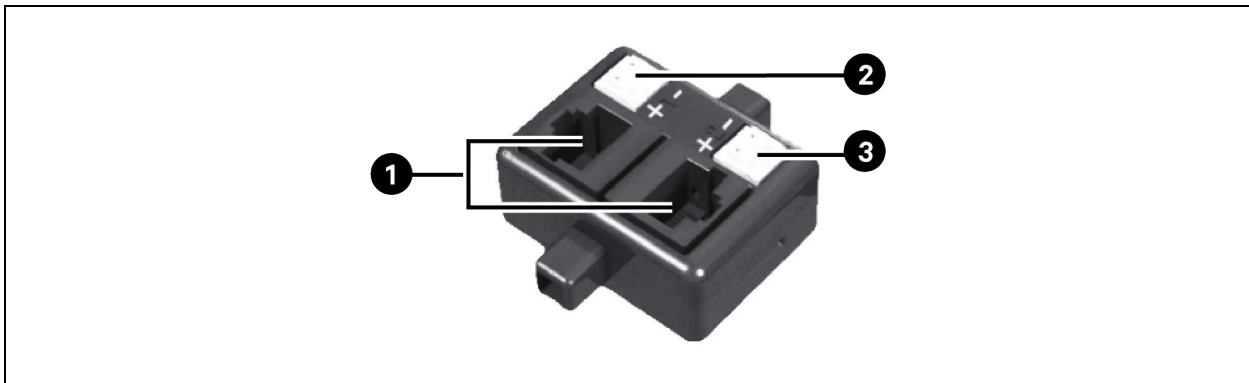

Item	Description
1	RJ45 connections (identical)
2	Terminal 1
3	Terminal 2

6.4 Installation and Connection of the Door Contact Switch

One door contact switch set is part of the monitoring package.

The article code of an additional door contact switch set is 08.014.590.0

Figure 6.14 Door Contact Switch Installation and Connection

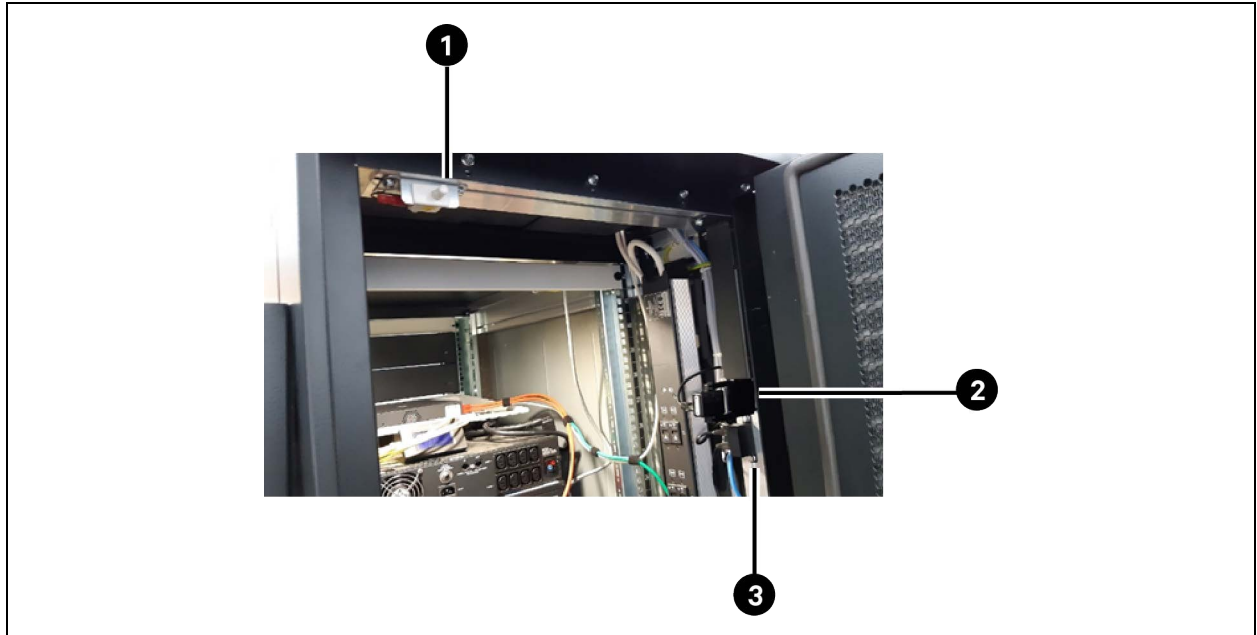

Item	Description
1	Door contact
2	Upper SN-T temperature
3	One wire adapter door contact

Up to two door contact switches can be connected to the OneWire Adapter UFN0001. If fewer are connect-ed, the unused terminal must be bridged. Otherwise, an open door is always detected.

Door contact switches must be connected to the UFN0001 in such a way that the switch is closed when the door is closed and open when the door is open. The polarity of a door contact switch is irrelevant.

Figure 6.15 Connection of a Door Contact Switch on the OneWire Adapter



6.5 Installation and Connection the Leak Sensor

Article code of the leak sensor set: 08.014.591.0

Figure 6.16 Leak Sensor

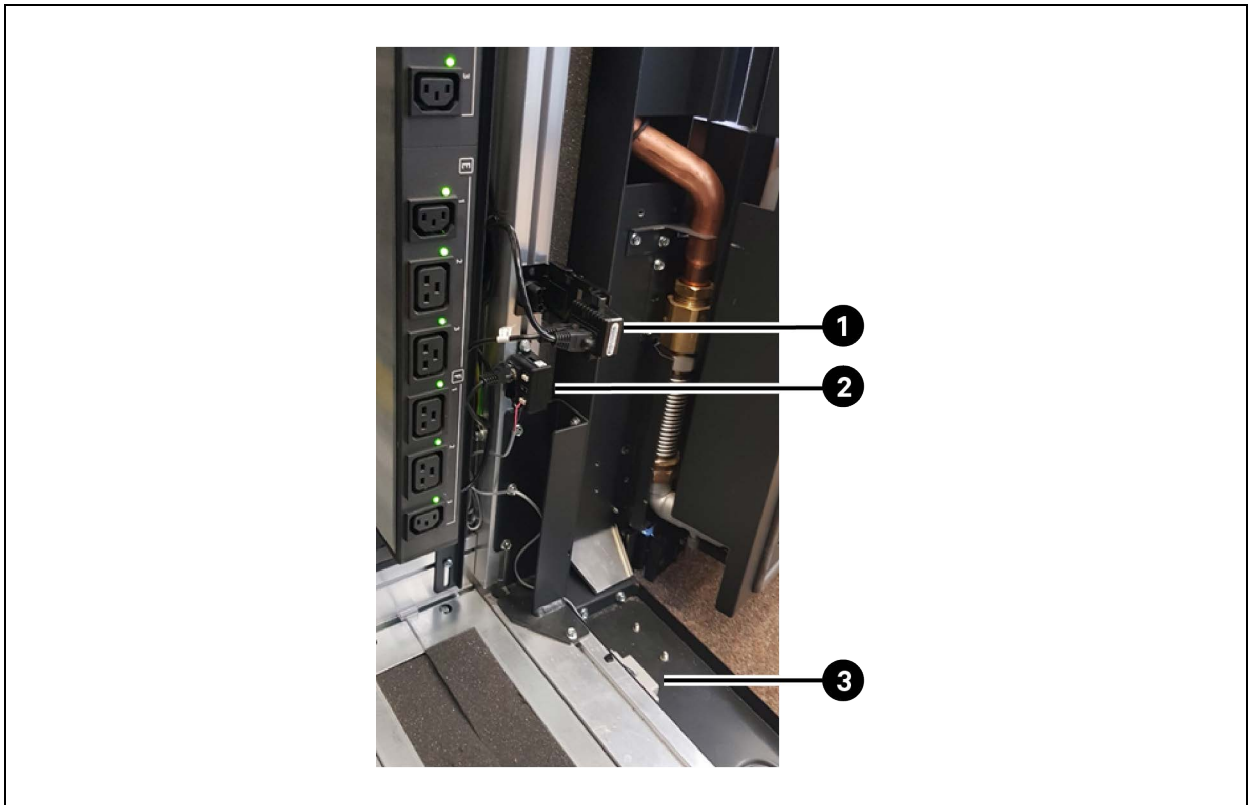

Item	Description
1	Lower SN-T temperature sensor
2	One wire adapter leakage detector
3	Leakage detector

Up to two leakage detector sensors can be connected to the UFN0001. In contrast to the door contact switch, an unused terminal on the UFN0001 must remain free.

The GRI 2800 leak sensor closes the electrical contact when a leak is detected. When connecting, the polarity must be observed.

Figure 6.17 Connection of the Leak Sensor on the OneWire Adapter

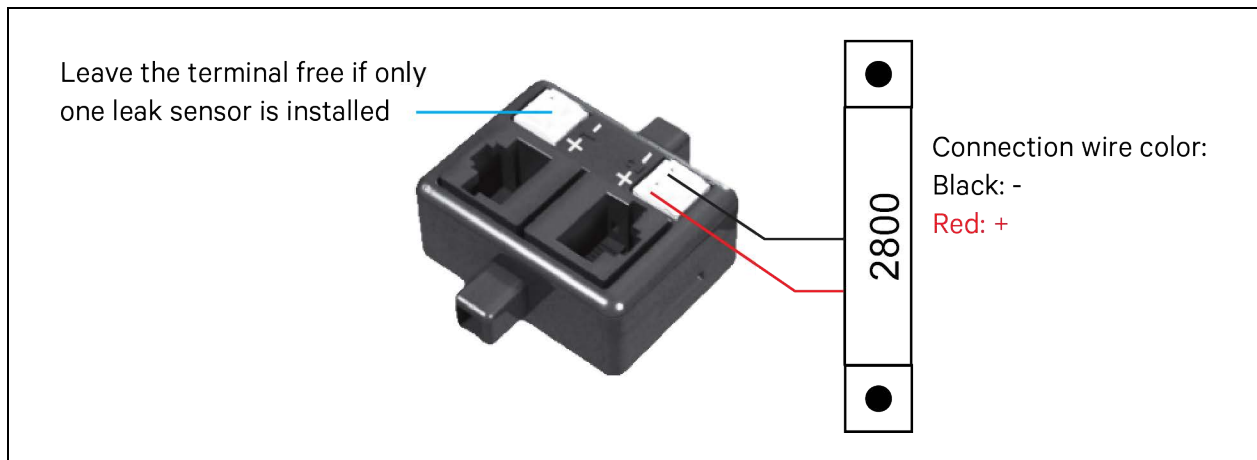

6.6 Installation and Connection of the Water Flow Modulating Valve

The water flow is controlled by the return water temperature. In case of a temperature increase, the flow rate will be increased to correct the temperature. The water flow modulating valve is also connected to the RJ45 connector of the Vertiv™ Liebert® DCDactive. The electrical supply is separate and not provided via the Liebert® DCDactive. The controller is automatically recognised by the Liebert® DCDactive and starts controlling the return water temperature by modulating the flow rate immediately after the Vertiv™ Liebert® DCD is started according to the set parameters. For further information see [Water Flow Modulating Valve](#) on page 69.

6.7 Optional Connection of the Supply and Return Water Temperature Sensor

The CEV0111E distributor has two RJ45 connectors for connection to the Vertiv™ Liebert® DCDactive or for looping the bus through to other units. One sleeve sensor can be connected to each of the two RJ10 connectors. The sensor is assigned to the supply or return temperature by teaching it on the unit display (see **Figure 6.18** below).

Figure 6.18 Supply and Return Temperature Sensor via Distributor CEV0111B

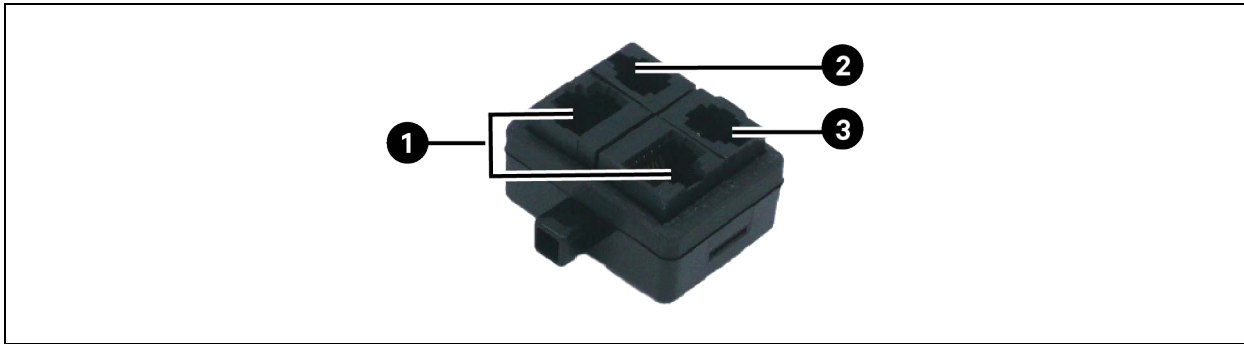

Item	Description
1	RJ45 connections (identical)
2	Sleeve Sensor Connection
3	Sleeve Sensor Connection

7 Operation

Vertiv™ Liebert® DCDactive cannot be operated in its standard form. The unit runs automatically once the power is turned on and regulates the differential pressure. Only the optional TFT display can be used to operate the unit.

NOTE: This is related to the TFT display. The unit cannot be operated if TFT display is not present.

7.1 Menu of the TFT Display

7.1.1 Main Screen with Detailed Menus

Figure 7.1 Main Screen

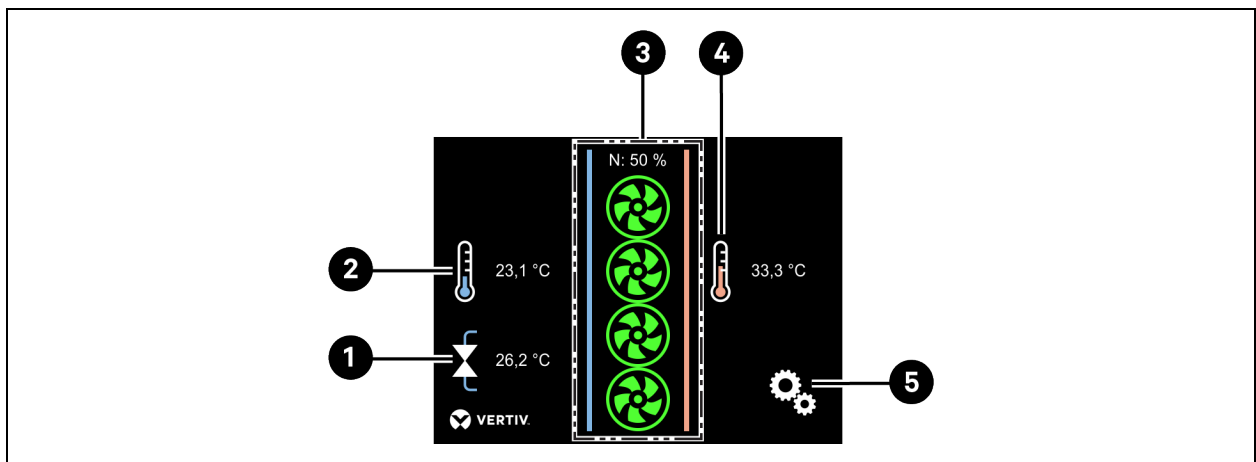

Item	Icon	Description
1	Water Temperature Indicator	Water temperature of the Return Temperature Controller. Tap to go to the Return Temperature Controller detail menu.
2	Exhaust Air Temperature Sensor (Cold Side)	Average temperature of all Exhaust Air Temperature Sensors (Cold Side). Tap to go to the Exhaust Air Temperatures detail menu.
3	Fan Speed Indicator	Representation of the set-point speed of the fans in percent. The color of the individual fan symbols indicates operation OK (Green) or a Fault (Red). Tap on the area to go to the Speed Display detail menu.
4	Exhaust Air Temperature Sensor (Hot Side)	Display of the average temperature of all temperature sensors in the server (hot side). Tap to go to the Server Temperatures detail menu.
5	Settings Menu	Tap to go to the Settings Menu.

Figure 7.2 Main Screen when a Door Contact Switch is Installed and a Door is Open

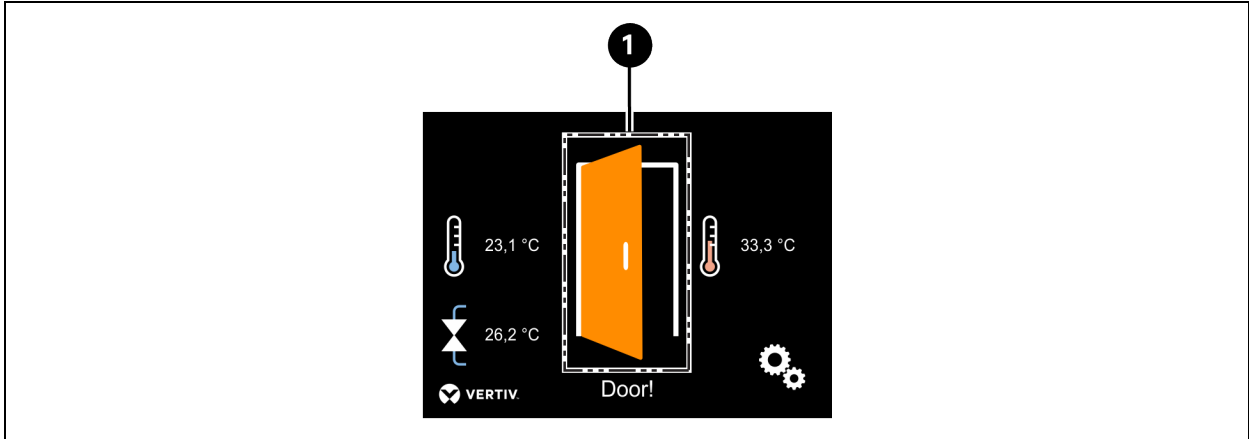

Item	Icon	Description
1	Open Door	Display of the Main Menu when an open door is detected. NOTE: A door contact switch is installed.

Figure 7.3 Speed Display Detail Menu

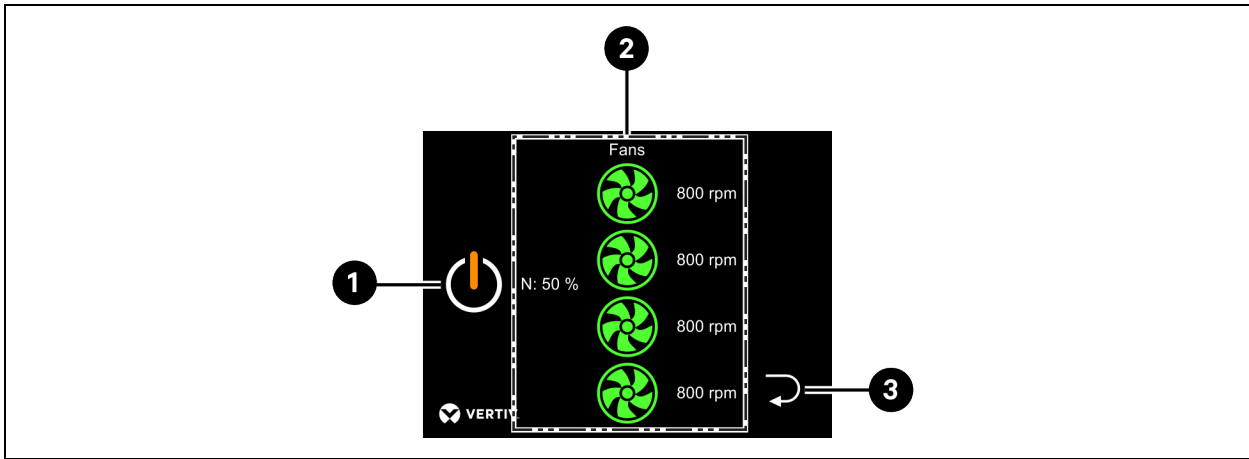

Item	Icon	Description
1	Power Symbol	Tap on the Power Symbol to access the Service Shutdown Menu.
2	Fans	Representation of the set-point speed of the fans in percent. Current fan speeds are displayed alongside the fan symbols. NOTE: The color of the individual fan symbols indicates operation OK (Green) or a Fault (Red).
3	Return Menu	Tap to return to the Main Menu.

Figure 7.4 Service Shutdown

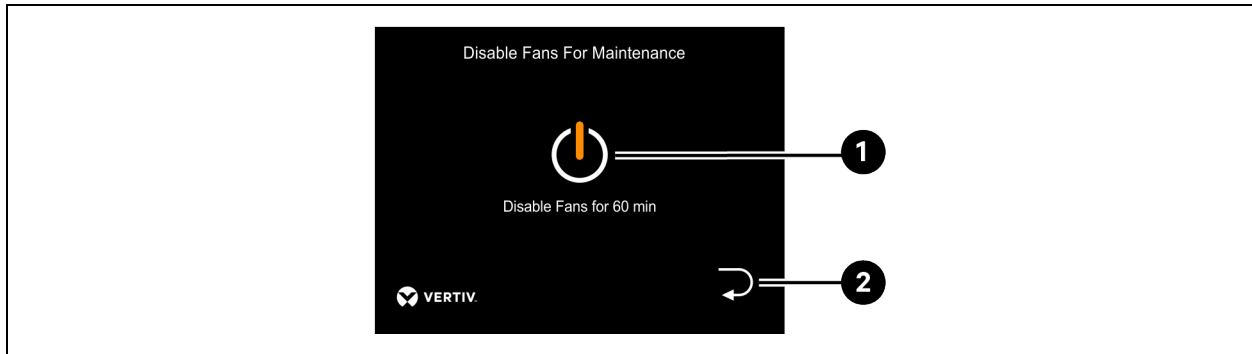

Item	Icon	Description
1	Power Symbol	Tap on the Power Symbol to disable the fans and show the countdown.
2	Return Menu	Tap to return to the Speed Display detail menu.

Figure 7.5 Countdown of the Remaining Service Shutdown Time

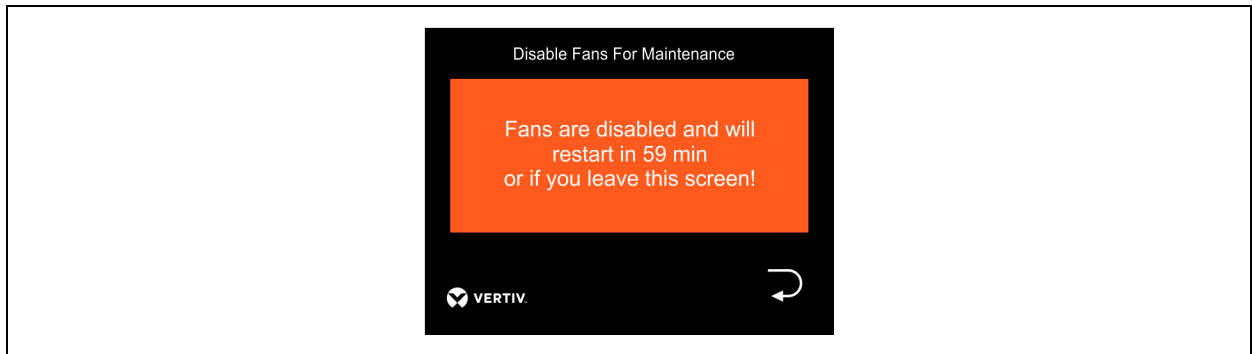
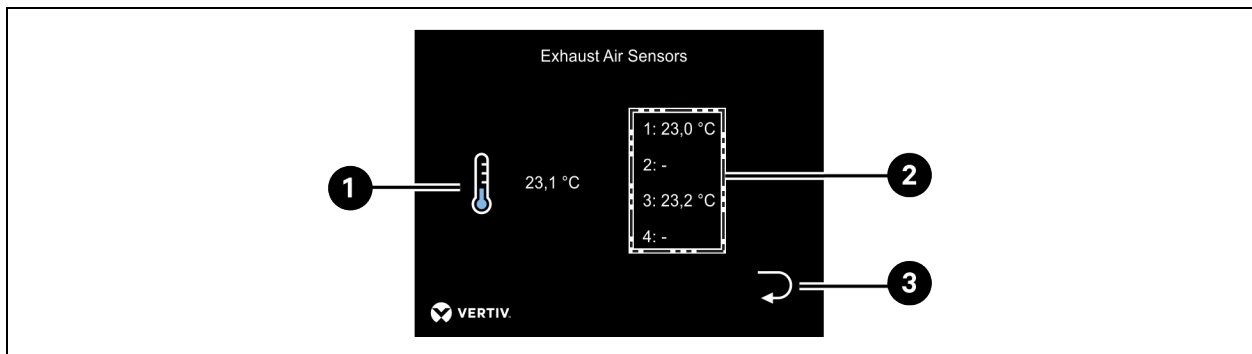

Figure 7.5 above shows display of the remaining time until automatic restart of the fans.

Figure 7.6 Exhaust Air Temperatures Detail Menu



Item	Description
1	Display of the average temperature of all Exhaust Air Temperature sensors installed in the fan module (Cold Side).
2	Display of the individual sensor measured values. From these values the average value displayed on the left side is calculated.
3	Tap to return to the Main Menu.

Figure 7.7 Server Temperatures Detail Menu

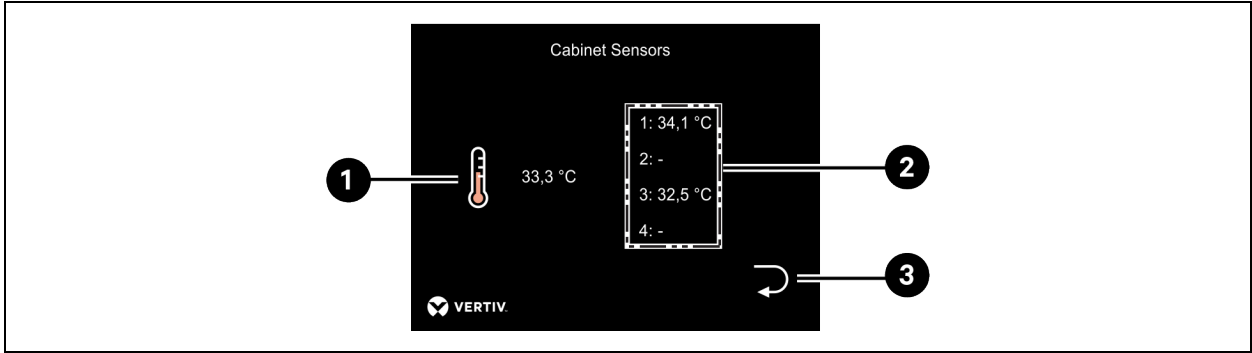

Item	Description
1	Display of the average temperature of all temperature sensors installed in the server cabinet (hot side).
2	Display of the individual sensor measured values. From these values the average value displayed on the left side is calculated.
3	Tap to return to the Main Menu.

Figure 7.8 Return Temperature Controller Detail Menu

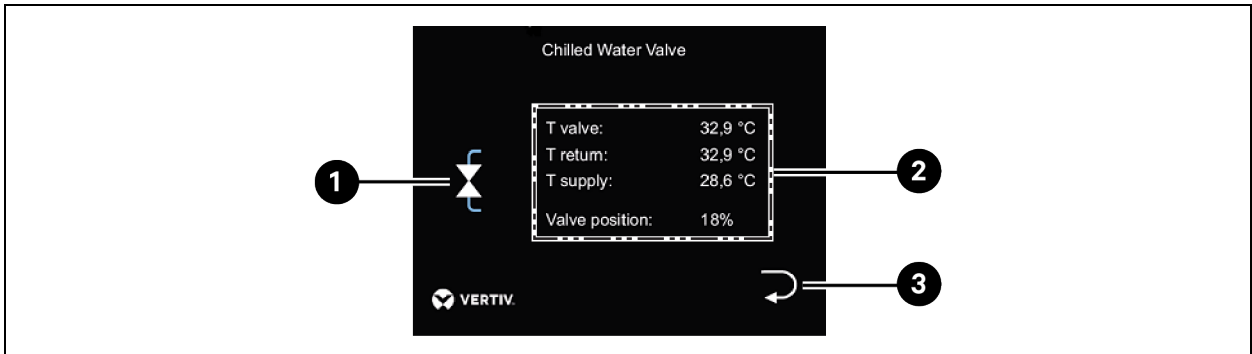

Item	Icon	Description
1	Return Flow Temperature Controller	Tap to go to the Return Flow Temperature Controller detail menu.
2	Water Temperature and Valve Position Indicator	Display of the currently measured water temperatures: <ul style="list-style-type: none"> Return flow temperature controller. Return flow. Flow and the valve set-point position of the return temperature controller.
3	Return Menu	Tap to return to the Main Menu.

NOTE: This menu can only be accessed if a return temperature controller is installed.

7.1.2 Settings Menu

Figure 7.9 Settings Menu

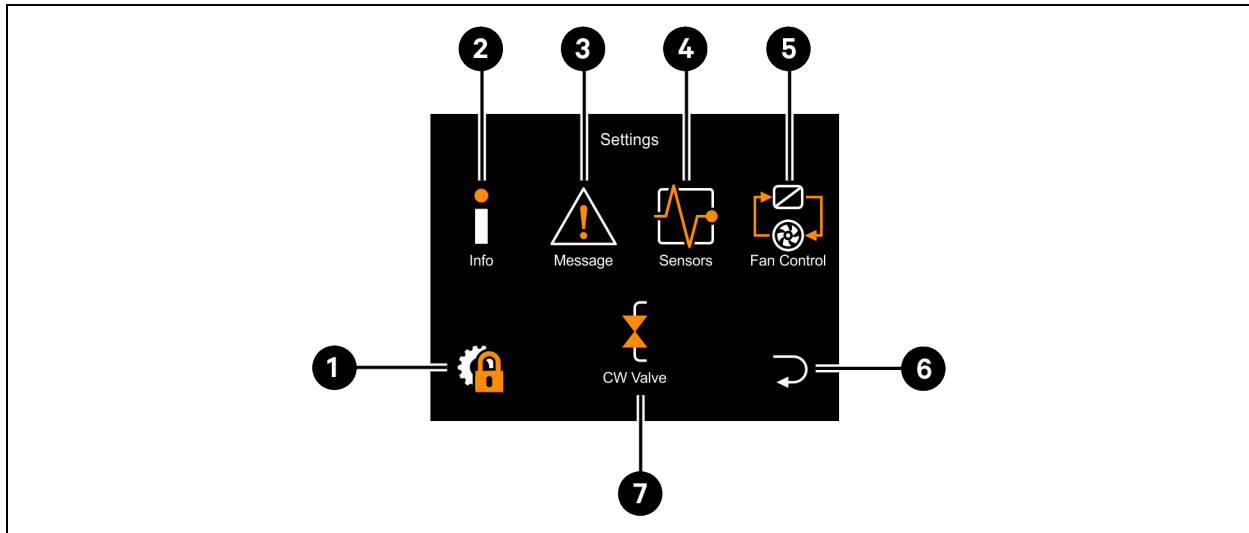

Item	Icon	Description
1	Password Protected Set-up Menu	Tap to enter the Password Protected Set-up Menu. Password: 94424.
2	Info	Tap to go to the Info Menu.
3	Messages	Tap to go to the Messages Menu.
4	Sensors	Tap to go to the Sensors Menu.
5	Fan Control	Tap to go to the Fan Control Menu.
6	Return Menu	Tap to return to the Main Menu.
7	Return Flow Temperature Controller	Tap to go to the Return Flow Temperature Controller.

Info and Message Menu

NOTE: There are no operations in the Info and Message menu. They are therefore not shown here.

Sensors Menu

Figure 7.10 Sensors Sub-menu

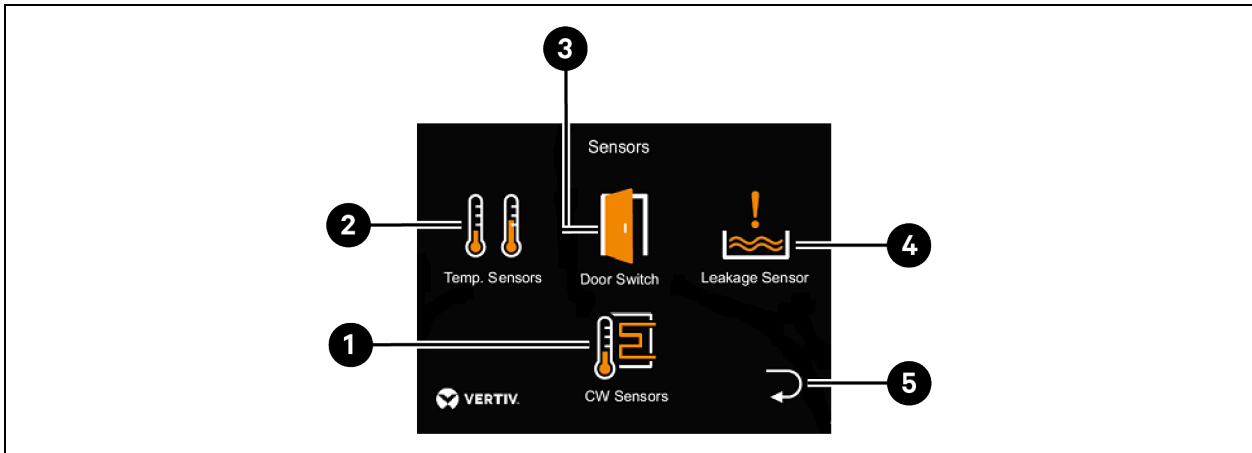

Item	Icon	Description
1	CW Sensors	Tap to go to the Flow/Return Temperature Sensors Sub-menu.
2	Temperature Sensors	Tap to go to the Temperature Sensors Sub-menu.
3	Door Switch	Tap to go to the Door Contact Sensor Sub-menu.
4	Leakage Sensor	Tap to go to the Leak Sensor Sub-menu.
5	Return Menu	Tap to return to the Settings Menu.

Figure 7.11 Temperature Sensors Sub-menu

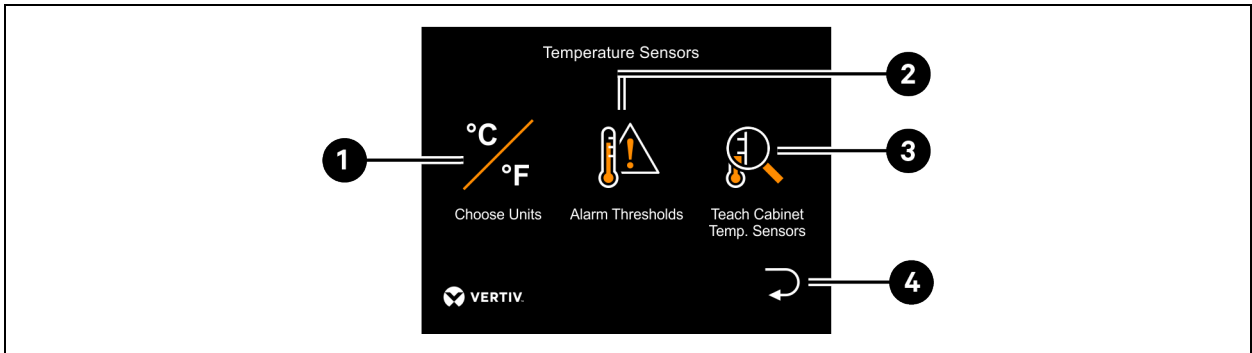

Item	Icon	Description
1	Choose Units	Tap to go to the Select Units Sub-menu.
2	Alarm Thresholds	Tap to go to the Alarm Threshold Values Sub-menu.
3	Teaching Sensor	Tap to go to the Teach Servers Temperature Sensors Sub-menu.
4	Return Menu	Tap to return to the Temperature sensors Menu.

Figure 7.12 Alarm Threshold Values Sub-menu

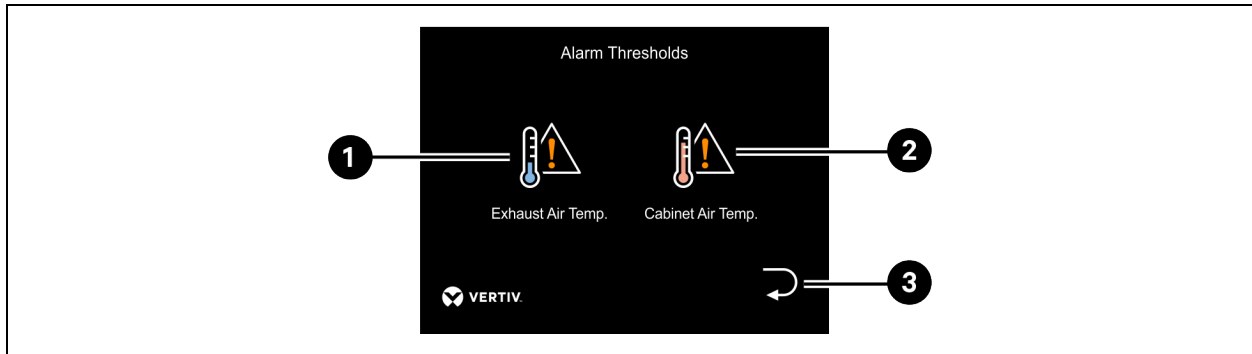

Item	Icon	Description
1	Exhaust Air Temperatures	Tap to set the threshold values for the Exhaust Air Temperatures.
2	Cabinet Air Temperatures	Tap to set the threshold values for the Server Cabinet Temperatures.
3	Return Menu	Tap to return to the Temperature Sensors Menu.

Figure 7.13 Set Alarm Thresholds Sub-menu for Exhaust Air and Server Temperatures

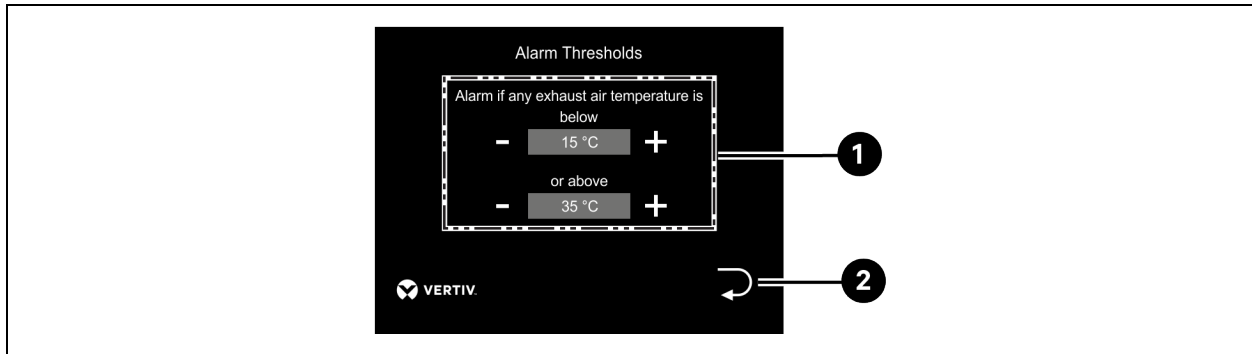

Item	Icon	Description
1	Alarm Thresholds	Lower and upper thresholds can be set for Exhaust Air Temperature.
2	Return Menu	Return to the Temperature Sensors Menu.

Figure 7.14 Set Alarm Thresholds Sub-menu for Exhaust Air and Server Temperatures

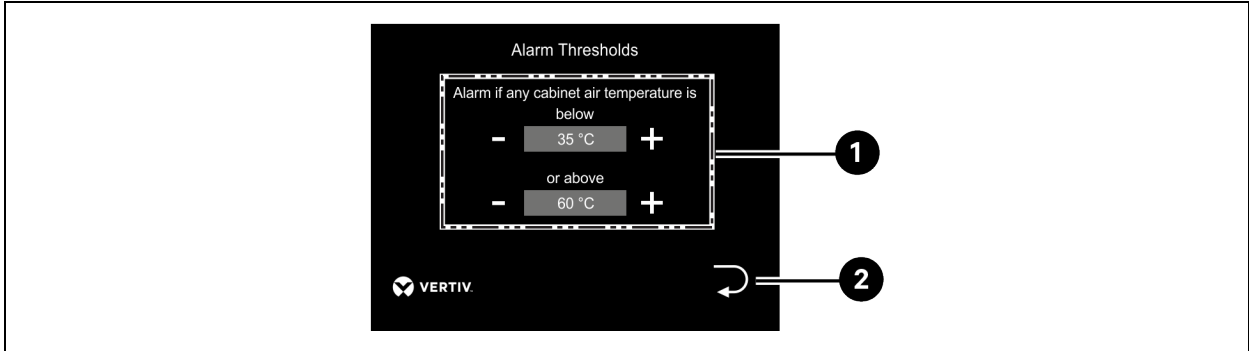

Item	Icon	Description
1	Alarm Thresholds	Lower and upper thresholds can be set for Cabinet Air Temperatures (Server Temperatures).
2	Return Menu	Return to the Temperature Sensors Menu.

NOTE: If any of the Exhaust Air Temperature or Server Temperature exceeds or falls below the threshold value, an alarm is generated.

Figure 7.15 Select Units Sub-menu

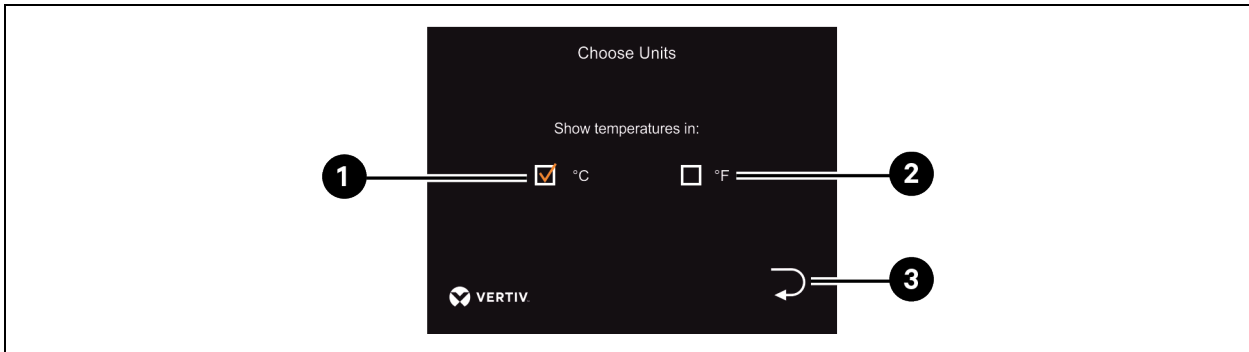

Item	Icon	Description
1	Temperature setting in (°C)	If this check mark is set, all temperatures are displayed in °C. Tap to select unit to °C.
2	Temperature setting (°F)	If this check mark is set, all temperatures are displayed in °F. Tap to select unit to °F.
3	Return Menu	Return to the Temperature Sensors Menu.

NOTE: When changing the unit, all temperature settings are converted.

Figure 7.16 Teach Server Sensors Sub-menu

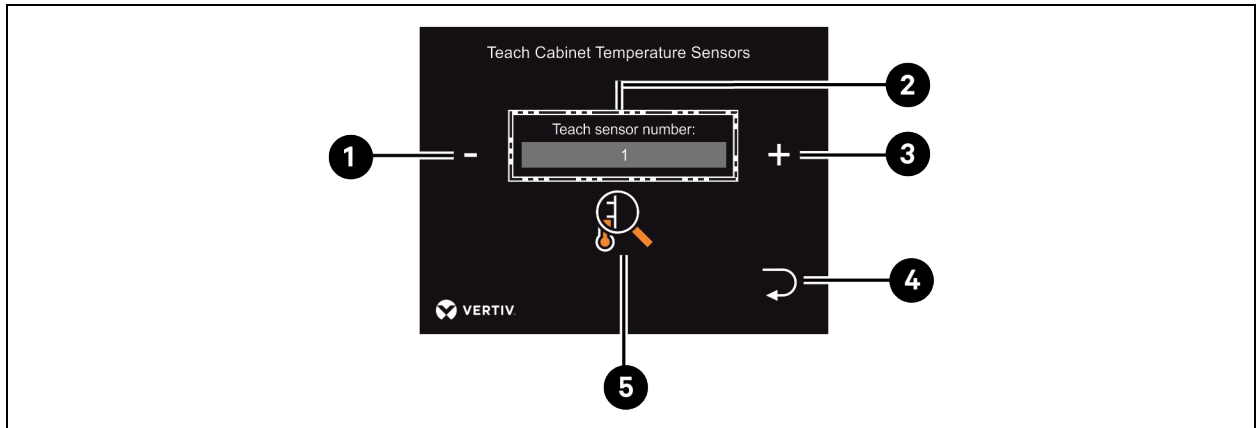

Item	Icon	Description
1	Minus (-)	Selection of the sensor number 1-4. Decrease the sensor number.
2	Display of Selected Sensor	Teaching of the Server Temperature Sensors.
3	Plus (+)	Selection of the sensor number 1-4. Increase the sensor number.
4	Return Menu	Back to the Temperature Sensors Menu.
5	Teaching Sensor	Start teaching of the selected sensor, see Figure 7.16 above .

NOTE: To decommission a sensor that has already been taught-in, start the teach-in process for the sensor number without the sensor connected.

NOTE: The sensors within the Vertiv™ Liebert® DCD35/50 Active can only be taught in the Password Protected Set-up Menu.

Figure 7.17 Door Contact Switch Sub-menu

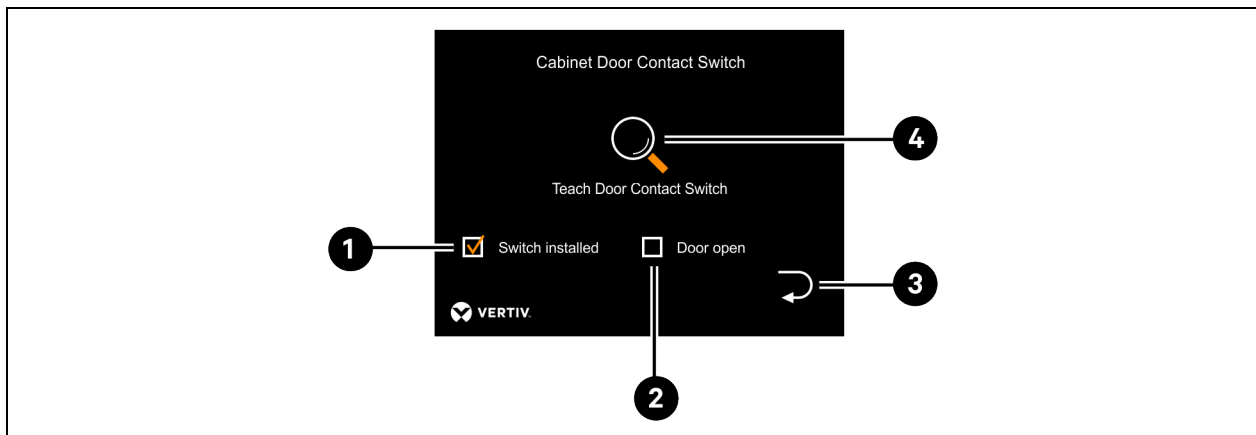

Item	Icon	Description
1	Switch Installed	Indicates whether a Door Contact Switch is taught.
2	Door Open	Indicates whether an open door has been detected. Only possible if a Door Contact Switch is taught.
3	Return Menu	Tap to return to the Sensors Menu.
4	Teaching Sensor	Start teaching of a Door Contact Switch, see Teaching Sensors on page 56.

Figure 7.18 Leak Sensor Sub-menu

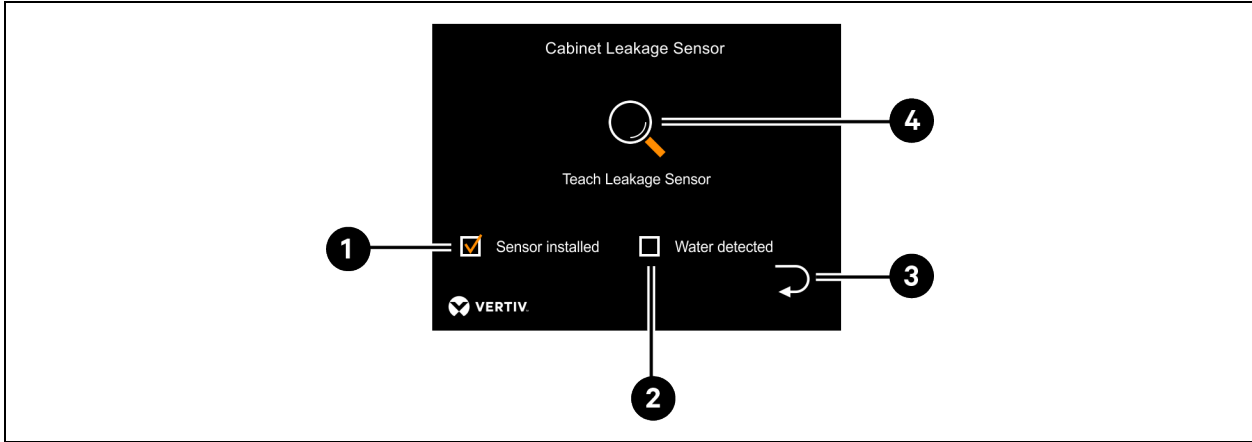

Item	Icon	Description
1	Sensor Installed	Indicates whether a Leak Sensor is taught.
2	Water Detected	Indicates whether a leak has been detected. Only possible if a Leak Sensor is taught.
3	Return Menu	Tap to return to the Sensors Menu.
4	Teaching Sensor	Start teaching of a Leak Sensor, see Figure 7.18 above.

Figure 7.19 Flow/Return Temperature Sensor Sub-menu

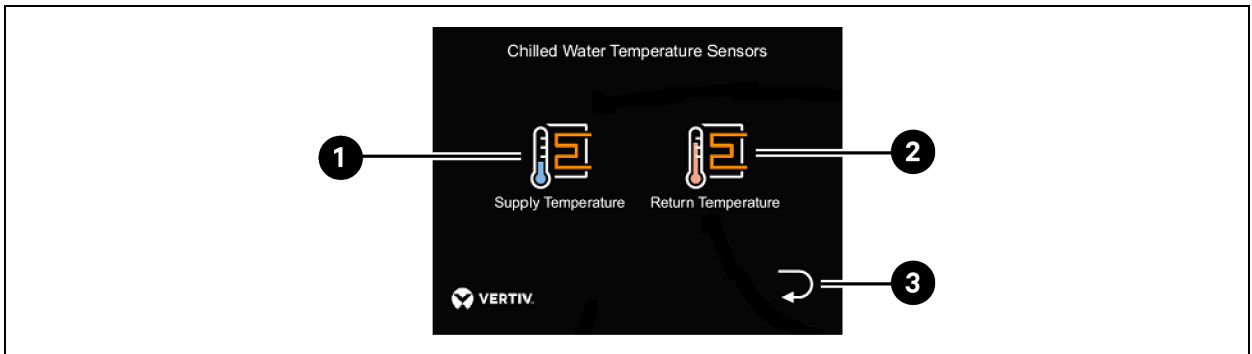

Item	Icon	Description
1	Supply Temperature	Tap to go to the Teach Flow Temperature Sensor Sub-menu.
2	Return Temperature	Tap to go to the Teach Return Temperature Sensor Sub-menu.
3	Return Menu	Tap to return to the Sensors Menu.

Figure 7.20 Flow Temperature Sensor Sub-menu

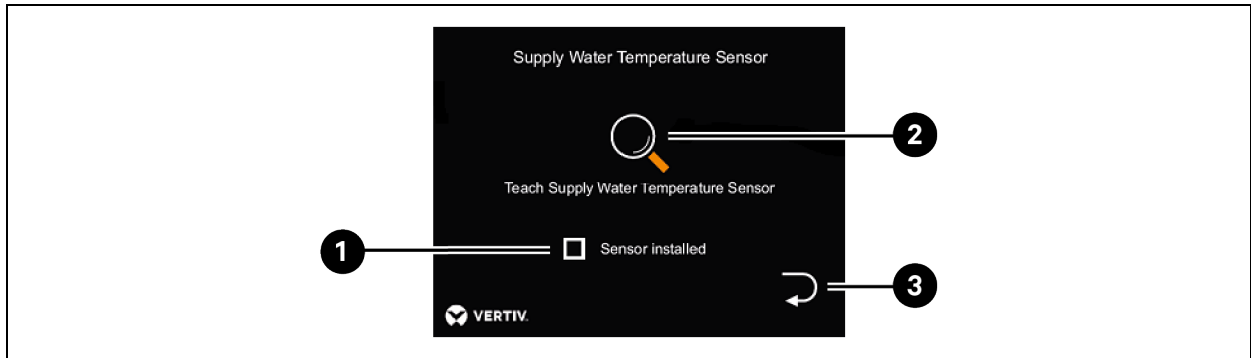

Item	Icon	Description
1	Sensor Installed	A check mark indicates whether a sensor is taught.
2	Teaching Sensor	Start teaching of the Flow Temperature Sensor, see Figure 7.20 above .
3	Return Menu	Tap to return to the Sensors Menu.

Figure 7.21 Return Temperature Sensor Sub-menu

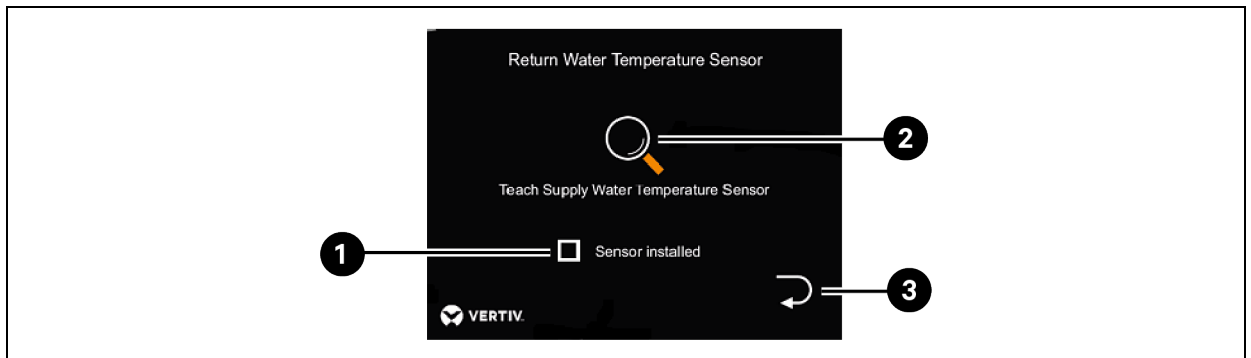

Item	Icon	Description
1	Sensor Installed	A check mark indicates whether a sensor is taught.
2	Teaching Sensor	Start teaching of the Return Temperature Sensor, see Figure 7.21 above .
3	Return Menu	Tap to return to the Sensors menu.

Fan Control Menu

Figure 7.22 Fan Control Sub-menu

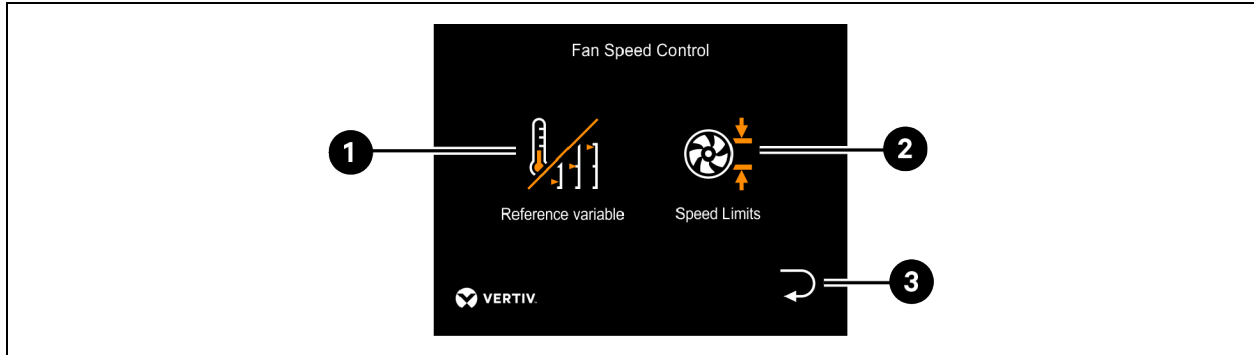

Item	Icon	Description
1	Reference Variable	Tap to go to the Reference Variable Sub-menu.
2	Speed Limits	Tap to go to the Speed Limits Sub-menu.
3	Return Menu	Tap to return to the Settings Menu.

NOTE: If no temperature sensor is installed in the server, an error is displayed when temperature control is selected.

Figure 7.23 Reference Variable Sub-menu

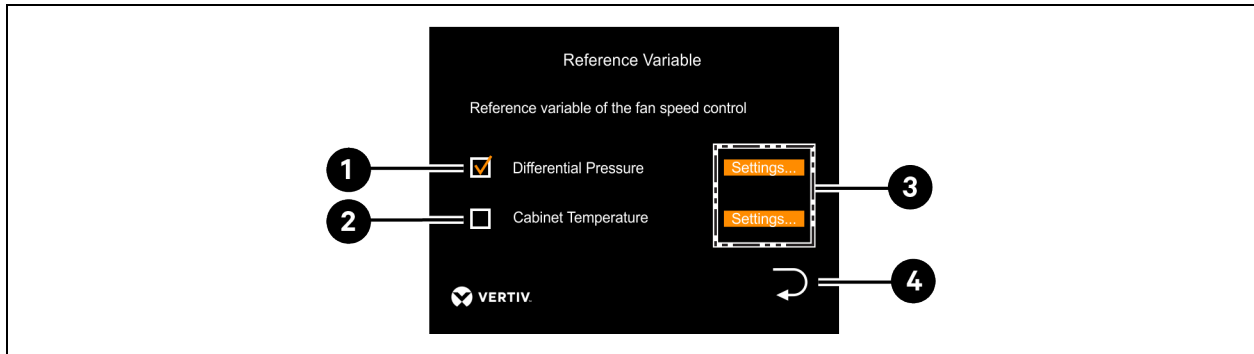

Item	Icon	Description
1	Differential Pressure Control	Tap to go to the Differential Pressure Control Sub-menu.
2	Cabinet Temperature	Tap to go to the Server Temperature Control Sub-menu.
3	Settings Tab	Tap on Settings to go to the respective Sub-menu: <ul style="list-style-type: none"> Differential Pressure Control Server Temperature Control
4	Return Menu	Tap to return to the Fan Control Menu.

NOTE: Determination of the reference variable used to control the fan speed.

Figure 7.24 Differential Pressure Control Sub-menu

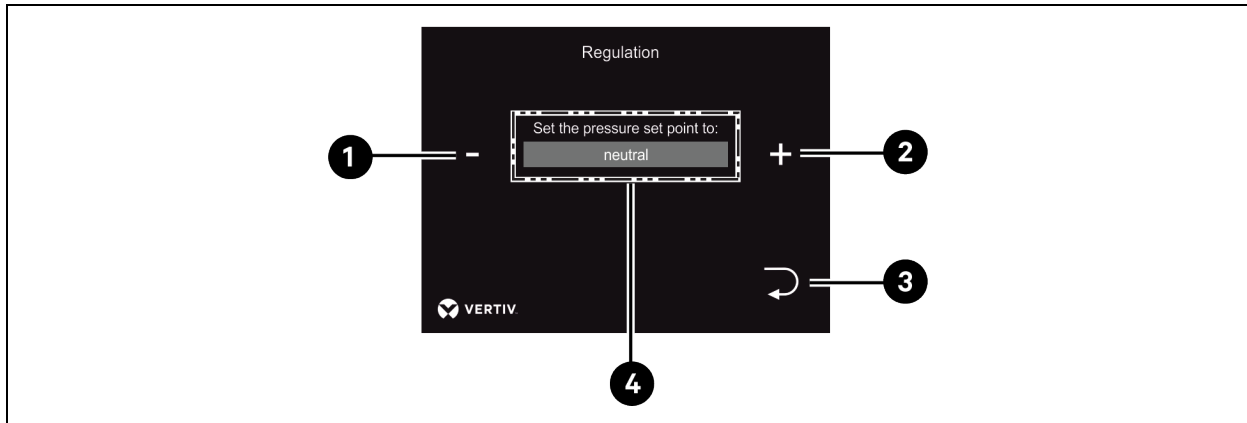

Item	Icon	Description
1	Minus (-)	Lower Level Selection of the Differential Pressure Set-point: <ul style="list-style-type: none"> • Low Overpressure • Neutral • Low Negative Pressure
2	Plus (+)	Higher Level Selection of the Differential Pressure Set-point: <ul style="list-style-type: none"> • Low Overpressure • Neutral • Low Negative Pressure
3	Return Menu	Tap to return to the Reference Variable Sub-menu.

Figure 7.25 Server Temperature Control Sub-menu

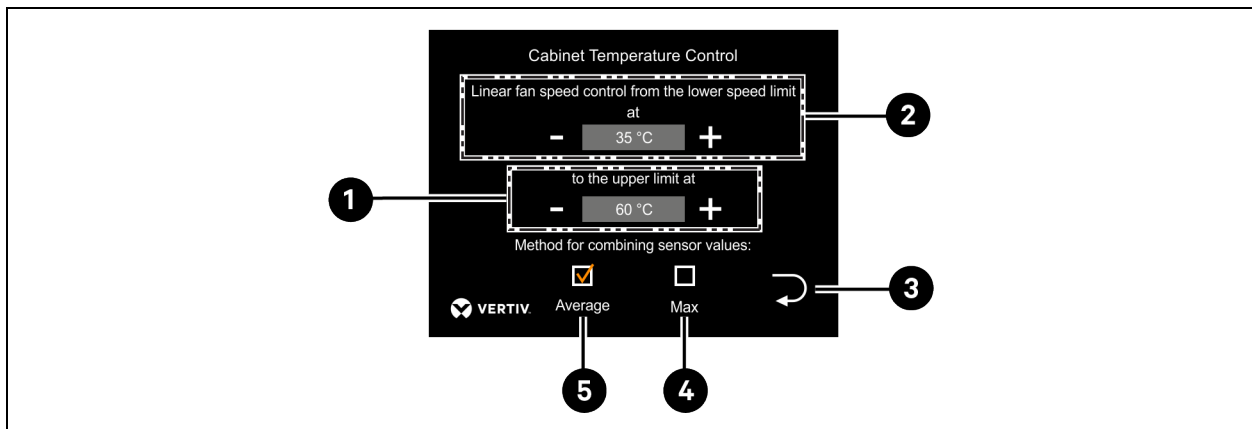

Item	Icon	Description
1	Cabinet Temperature (Upper Limit)	Setting of the upper temperature of the control. At this temperature the fan rotates at the upper speed limit.
2	Cabinet Temperature (Lower Limit)	Setting of the lower temperature of the control. At this temperature the fan rotates at the lower speed limit.
3	Return Menu	Back to the Reference Variable Menu.
4	Maximum Value	Select if the Highest value of all Server Temperature Sensors is used for the control.
5	Average Value	Select if the Average value of all Server Temperature Sensors is used for the control.

NOTE: Between the two temperature thresholds the speed is controlled in a linear fashion.

Figure 7.26 Server Speed Limits Sub-menu

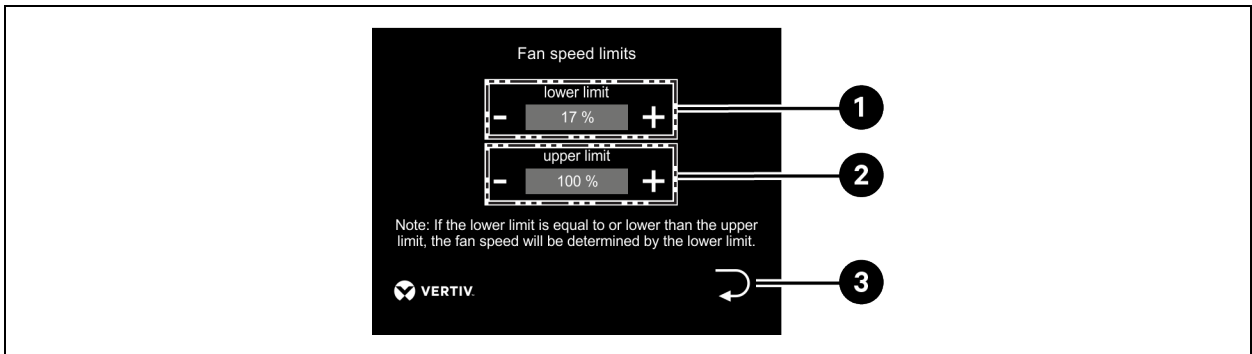

Item	Icon	Description
1	Fan Speed Limits (Lower Limit)	Setting of the lowest fan speed that can be achieved by differential pressure or temperature control.
2	Fan Speed Limits (Upper Limit)	Setting of the highest fan speed that can be achieved by differential pressure or temperature control.
3	Return Menu	Tap to return to the fan control.

NOTE: The starting speed and the speed in the event of an error are not affected by setting of the fan speeds.

Return Flow Temperature Controller Menu Settings

NOTE: These settings can be made independently of the presence of the return temperature controller.

Figure 7.27 Return Temperature Controller Sub-menu

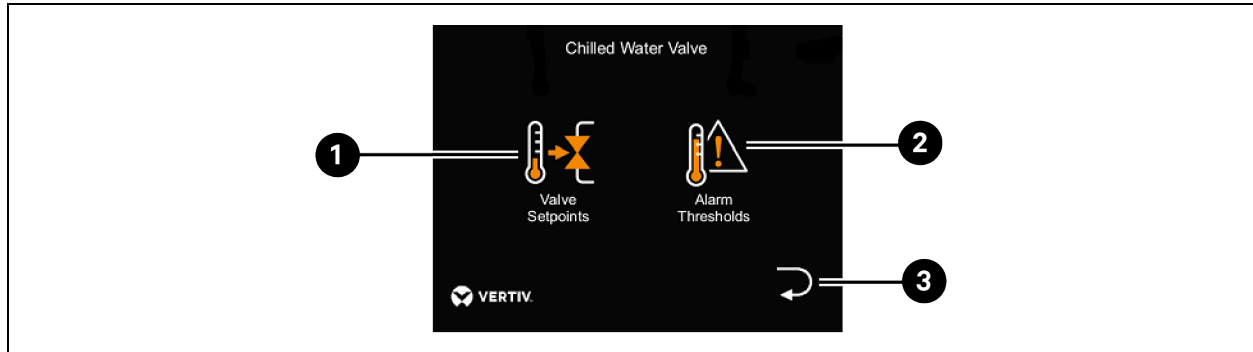

Item	Icon	Description
1	Valve Set-points	Tap to set the set-points of the return flow temperature control.
2	Alarm Thresholds	Tap to set the alarm thresholds for the return temperature of the Vertiv™ Liebert® DCD.
3	Return Menu	Tap to return to the Settings menu.

Figure 7.28 Set-point Temperature of the Return Temperature Control Sub-menu

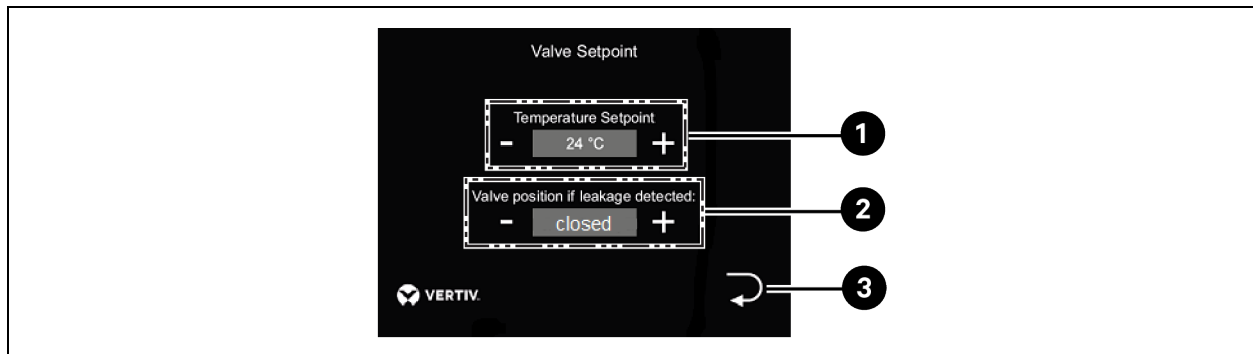

Item	Icon	Description
1	Temperature Set-point	Setting of the Return Set-point Temperature.
2	Valve Position	Selection of behaviour in the event of a leak (leak sensor required): <ul style="list-style-type: none"> • Closed • Neutral • Open.
3	Return Menu	Tap to return to the Return Temperature Controller Menu.

Figure 7.29 Alarm Thresholds of the Return Temperature Sub-menu

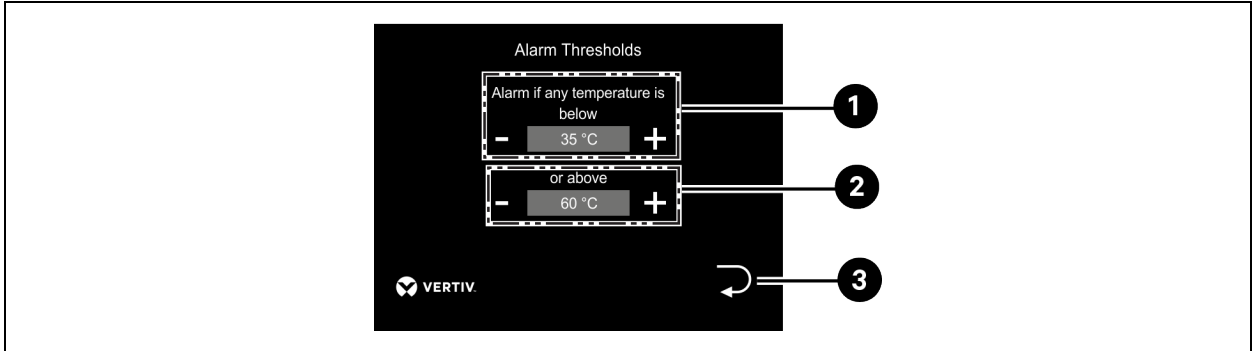

Item	Icon	Description
1	Return Temperature (Lower Limit)	If this threshold is not met, an alarm will be triggered.
2	Return Temperature (Upper Limit)	If this threshold is exceeded, an alarm will be triggered.
3	Return Menu	Tap to return to the Return Temperature Controller.

7.1.3 Set-up Menu

Figure 7.30 Set-up Menu

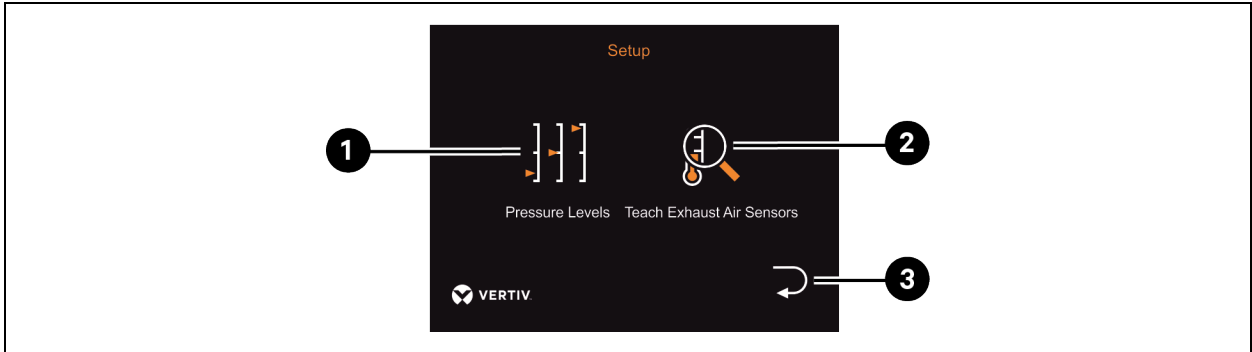

Item	Icon	Description
1	Pressure Levels	Tap to go to the Pressure Levels Sub-menu.
2	Teaching Sensor	Tap to go to the Teach Exhaust Air Sensors in the Vertiv™ Liebert® DCD35/50 Sub-menu.
3	Return Menu	Tap to go to the Settings Menu.

NOTE: The exhaust air sensors are supplied taught and therefore do not need to be taught during commissioning.

Figure 7.31 Teach Exhaust Air Sensors in the Vertiv™ Liebert® DCD35/50 Sub-menu

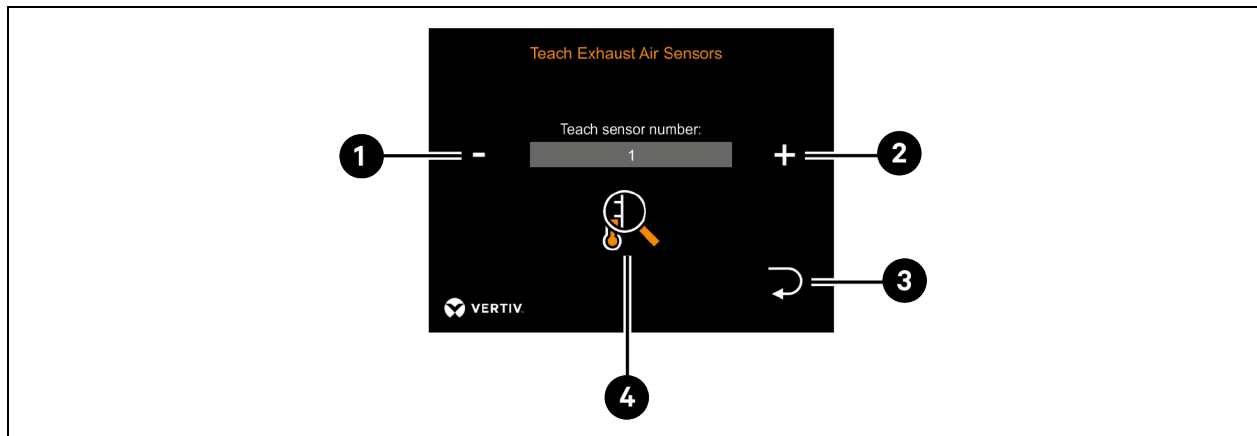

Item	Icon	Description
1	Minus (-)	Selection of the sensor number 1-4 Decrease the sensor number.
2	Plus (+)	Selection of the sensor number 1-4 Increase the sensor number.
3	Return Menu	Tap to return to the Settings Menu.
4	Teaching Sensor	Start teaching of the selected sensor number See Teaching Sensors on the next page .

NOTE: For repair purposes, the internal sensors in the fan module can be taught in this Sub-menu.

Figure 7.32 Pressure Levels Sub-menu

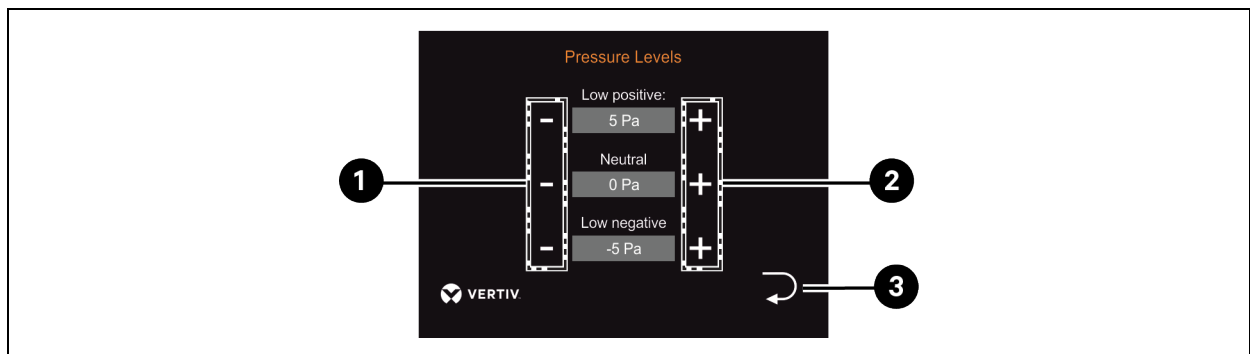

Item	Icon	Description
1	Minus (-)	Setting of the set-point differential pressure for the levels that can be selected by the user: <ul style="list-style-type: none"> Low over pressure Neutral Low negative pressure.
2	Plus (+)	Setting of the set-point differential pressure for the levels that can be selected by the user: <ul style="list-style-type: none"> Low over pressure Neutral Low negative pressure.
3	Return Menu	Tap to return to the Settings Menu.

7.2 Teaching Sensors

NOTICE

The internal temperature sensors installed in the unit (exhaust air sensors) are supplied already taught. The internal sensors therefore do NOT have to be taught during commissioning.

Optional sensors can be connected to the RJ45 connector of the Vertiv™ Liebert® DCDactive. The sensors communicate with the Liebert® DCDactive via a OneWire bus. To use the sensors, they must be taught during commissioning. Temperature sensors and OneWire adapters for door contact switches and leak sensors can be taught-in. Since the various sensors work according to the same principle, the procedure for teaching-in is also identical.

The sensors within the Liebert® DCDactive also work according to the same principle. For repair purposes, the service technician can also teach these sensors via the Set-up menu.

NOTICE

When teaching-in a sensor, only one sensor may be connected at a time. Otherwise the teaching process will fail. Since the sensor circuits of the server cabinet sensors and the internal sensors in the Vertiv™ Liebert® DCD35/50 Active are separate, this only applies to the affected sensor circuit in each case.

Once a sensor has been correctly taught, it is stored by the Liebert® DCD35/50 Active. As soon as an already taught sensor is connected, it is evaluated by the unit. It takes up to maximum of 30 seconds to recognize the connection of a new sensor. In order to teach several sensors one after the other, a sensor that has already been taught can be disconnected without hesitation and reconnected later. A sensor which has already been taught can be disconnected from the unit for approx. one minute before an error message is generated.

NOTE: A sensor that has already been taught-in cannot be taught-in again under a different sensor number or a different function. It must first be deleted from the number or function you no longer want. Furthermore, the type of sensor must match the function (i.e., a OneWire adapter cannot be taught as a temperature sensor).

NOTICE

Since the temperature sensors and OneWire adapters are externally very similar, it is recommended that the sensors are first taught individually directly at the unit's RJ45 connection and then marked with the sensor number or function (door contact or leak). The sensors can then be installed and connected in the server cabinet.

To teach a temperature sensor, the following steps must be carried out in the specified order. The teaching procedure is the same for both sensor circuits and is therefore described here using screen examples for the server cabinet sensors.

- On the affected sensor circuit, all but the one sensor to be taught must be disconnected.

Figure 7.33

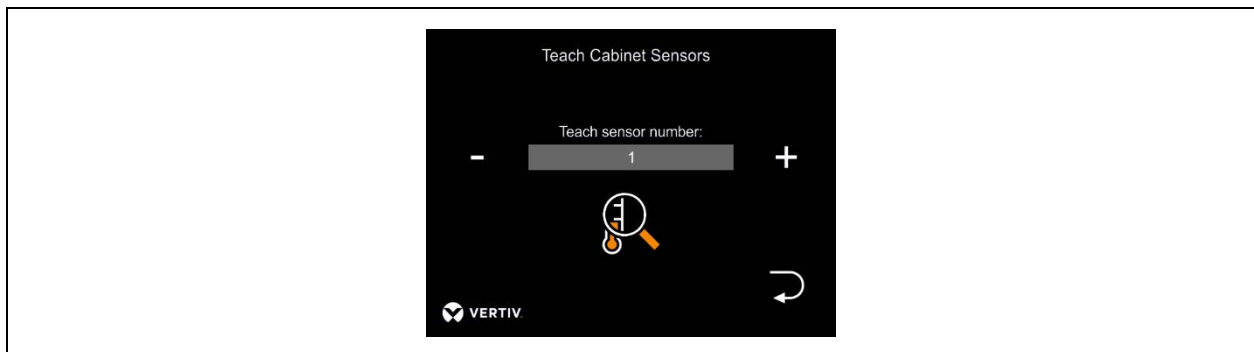

- In the "Teach sensor" menu, select the sensor number that the new sensor is to be allocated (numbering from top to bottom according to the fan positions simplifies the later localisation of the sensor).
- No numbering is necessary when teaching-in the flow and return temperature sensors.
- Tap on the magnifying glass icon for the teaching process.

Additional Notes:

- To delete a sensor that has already been taught, start the teaching process for the sensor number without a connected sensor.
- New teaching for overwriting.

Figure 7.34

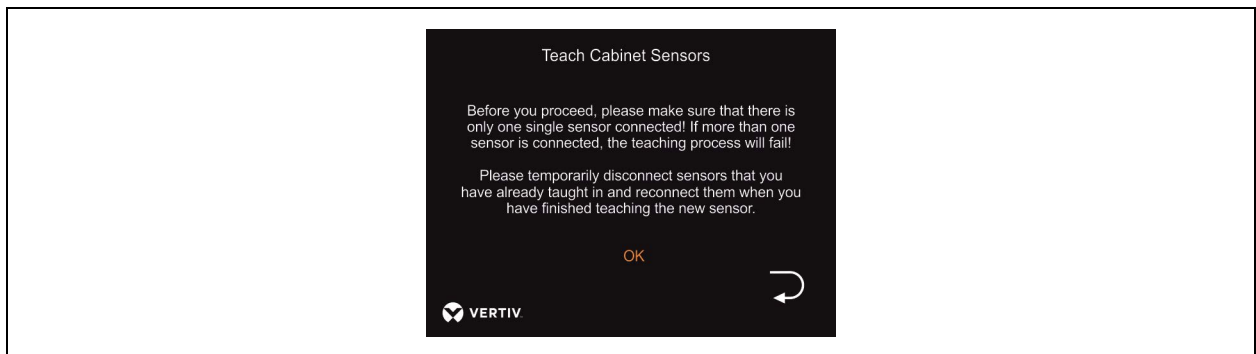

- Before starting the teaching process, a message appears again.
- OK starts the teaching process.
- Cancel by using the back arrow.

Figure 7.35

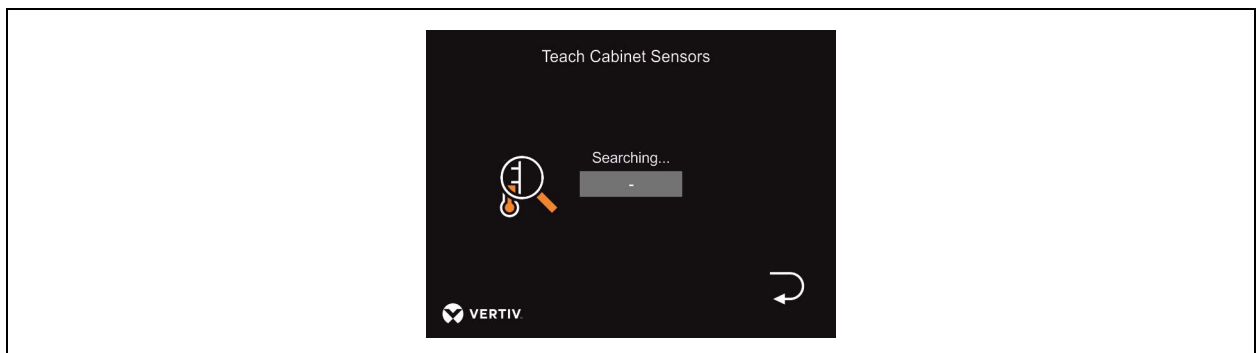

- During the search operation, "-" is displayed.
- The process takes a few seconds.
- Cancel by using the back arrow.

Figure 7.36

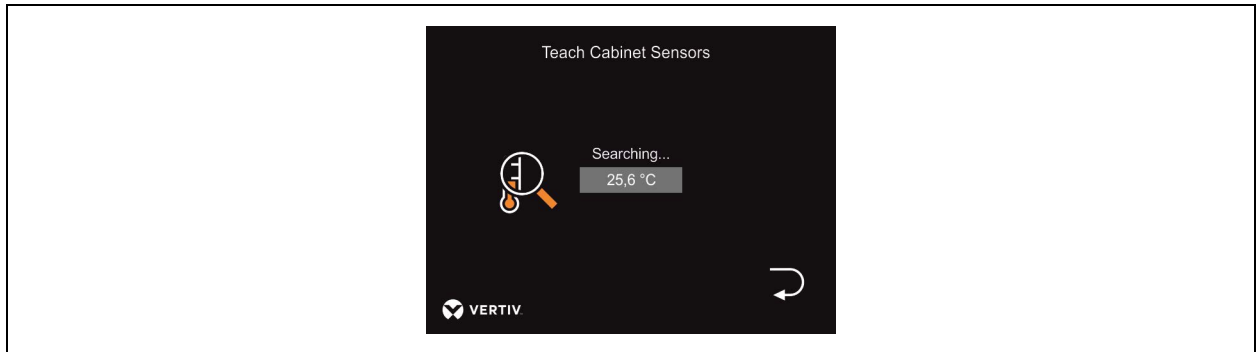

- If the sensor was successfully taught and saved, its temperature is displayed.
- The back arrow can be used to return to the sensor selection and the next sensor can be taught starting with step 1.
- When all sensors have been taught, the sensors disconnected for the teaching-in process can be reconnected.

To teach a OneWire adapter for a door contact switch or leak sensor, the following steps must be carried out in the specified order (screen examples show door contact switches).

- On the affected sensor circuit, all but the one sensor to be taught must be disconnected.

Figure 7.37

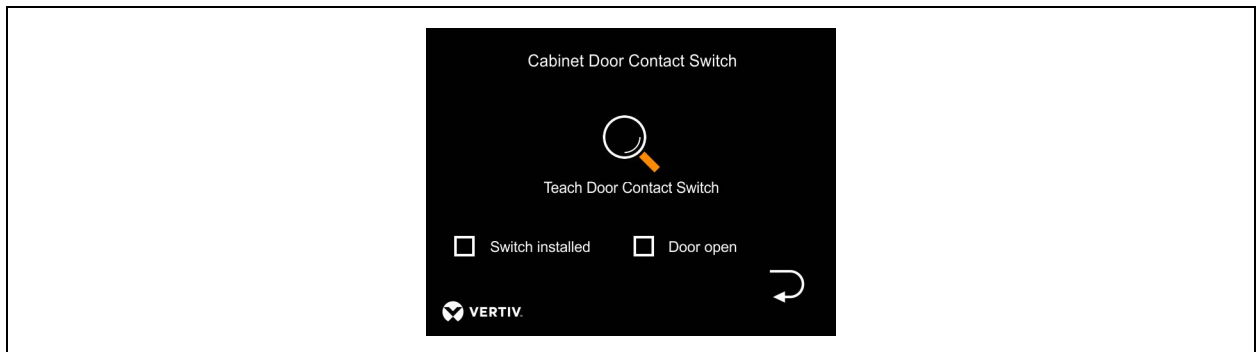

- Tap on the magnifying glass icon to continue with the teaching process.

Additional Notes:

- To delete a sensor that has already been taught, start the teaching process without a connected sensor.
- New teaching for overwriting.

Figure 7.38

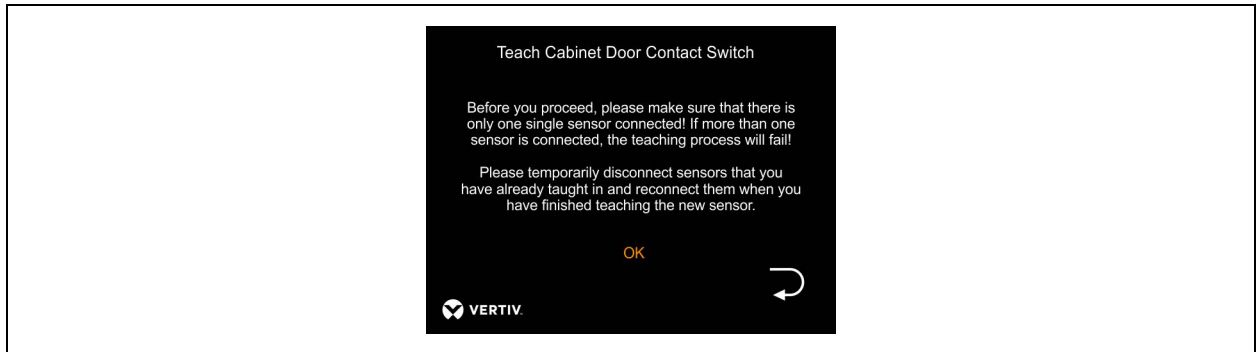

- Before starting the teaching process, a message appears again.
- OK starts the teaching process.
- Cancel by using the back arrow.

Figure 7.39

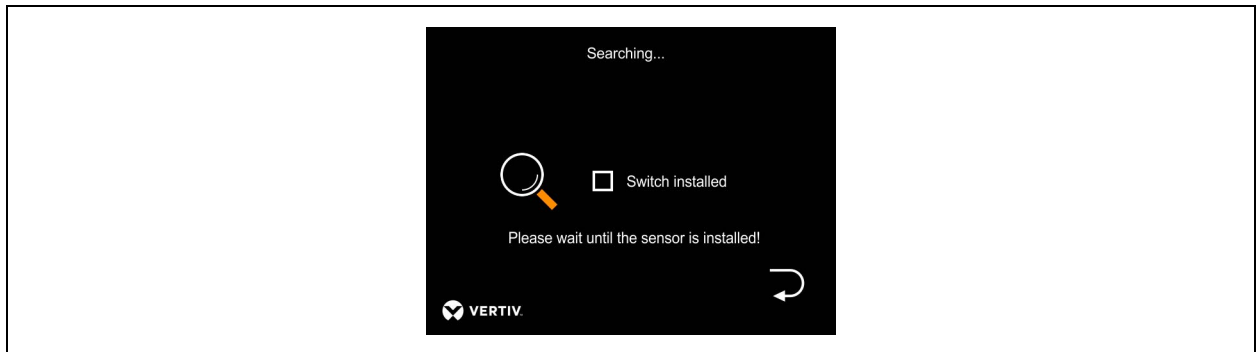

- The process takes a few seconds
- Cancel by using the back arrow.

Figure 7.40

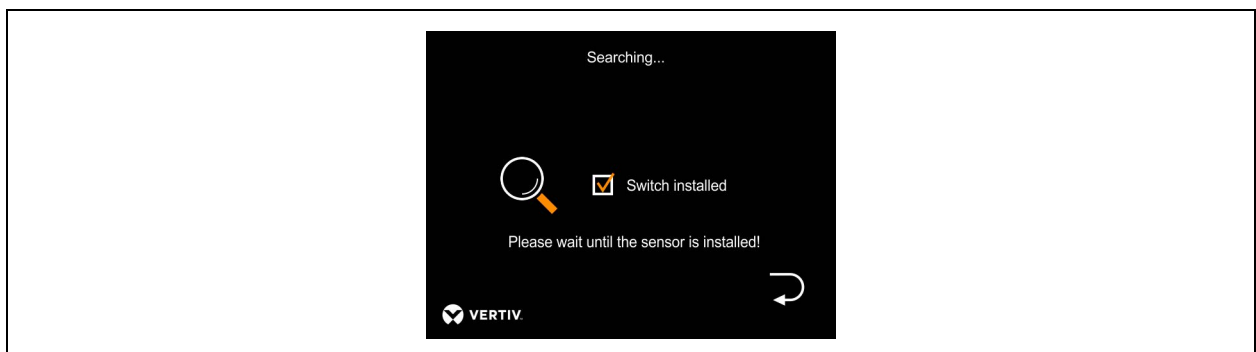

- When the sensor has been taught, the check mark appears.
- When all sensors have been taught, the sensors disconnected for the teaching-in process can be reconnected.

This page intentionally left blank

8 MODBUS TCP/IP Specification

8.1 Connection Settings

Define following parameters to use Modbus TCP interface:

- IP Address of the interface
- IP Gateway Address of the interface
- Enable or Disable DHCP (be sure you know the IP given to the interface from the DHCP-Server)
- Modbus ID

The configuration software "Modbus configuration DCDActive" allows you to set these parameters over a network connection. The Modbus interface's settings are password-protected. Once the parameters are changed, the device must be rebooted in order to enable the new values. When you utilise the configuration program, Modbus communication remains possible.

After the first start the following parameters are adjusted:

- IP: 192.168.1.35
- Gateway: 192.168.1.1
- DHCP off
- Modbus ID 1

NOTICE

For the first 30 seconds after powering the device the default values are active, so you are able to set new values during this period. This helps if you have forgotten the IP address. You can also activate the default values manually (see "[Activate Default Values](#) on the next page").

The device does not respond to a Modbus request within this period.

Please make sure that you remember the new IP address for Modbus connection and further adjustments. To adjust the parameters, you need start the program "Modbus configuration DCDActive".

Figure 8.1 Modbus Configuration

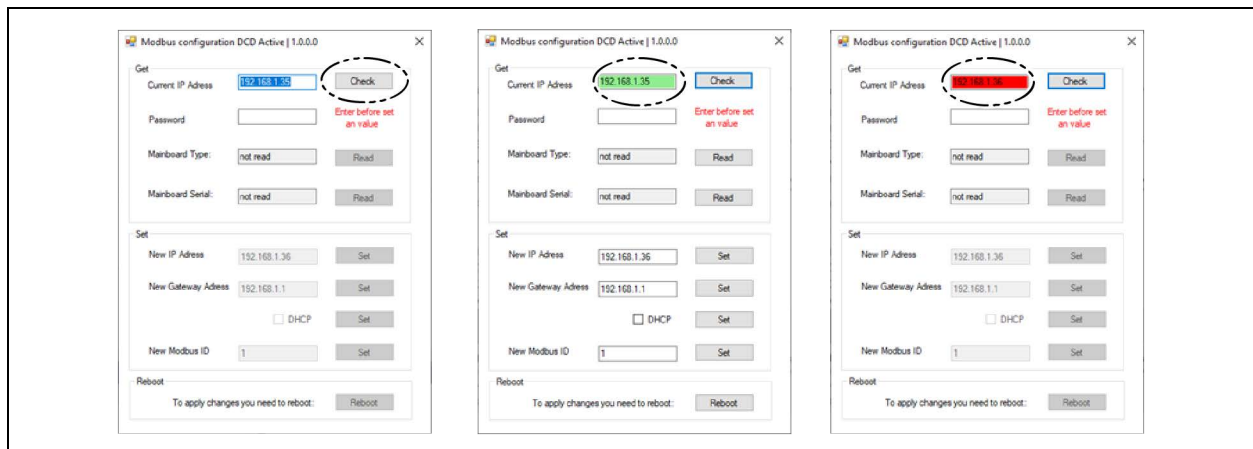

1. Enter the IP address of the device you need to adjust.
2. To make sure the interface is reachable, press the [Check]-Button. The IP address turns green and the [Set]-Button and [Read]-Button become active if the interface is reachable. The IP address will turn red if this is not done.
3. Enter the password 94424 to set the parameters else you will get "InternalServerError". Reading Type and Serial is possible without a password.
4. For setting parameters you need the password 94424 otherwise you will get an "InternalServerError". Reading Type and serial is possible without a password.

NOTE: The password cannot be changed by the user.

5. In order to be sure that you have the right device you can read the device and serial number and double-check these.
6. Once the parameters are set, you can set the interface settings. For each setting there is a separate [Set]-Button.
7. If it is successful a small OK-Message is displayed. If there is a problem with the interface or you have entered the wrong password an error message is displayed.

Figure 8.2 Modbus Configuration



8. After changing parameters please reboot the interface with the [REBOOT]-Button to enable the new adjusted values. Rebooting is only necessary, if you changed all the needed parameters.

8.2 Activate Default Values

If you do not remember the given IP address you have two ways to resolve this:

- For the first 30 seconds after powering the device the default values are active, so you have the chance to set new values during this period.
- OR
- Activate the default values manually.

Refer below steps to activate the default values:

1. Remove the *cover hood* from the Vertiv™ Liebert® DCD.
2. Remove the *small cover* on the top.

Figure 8.3 Cover Hood



3. Press the [CONNECT]-Button on the Modbus gateway for 3 seconds when power up the device.
4. The [STATUS]-LED on the Modbus gateway turns to orange if the interface enters the configuration mode:

Figure 8.4

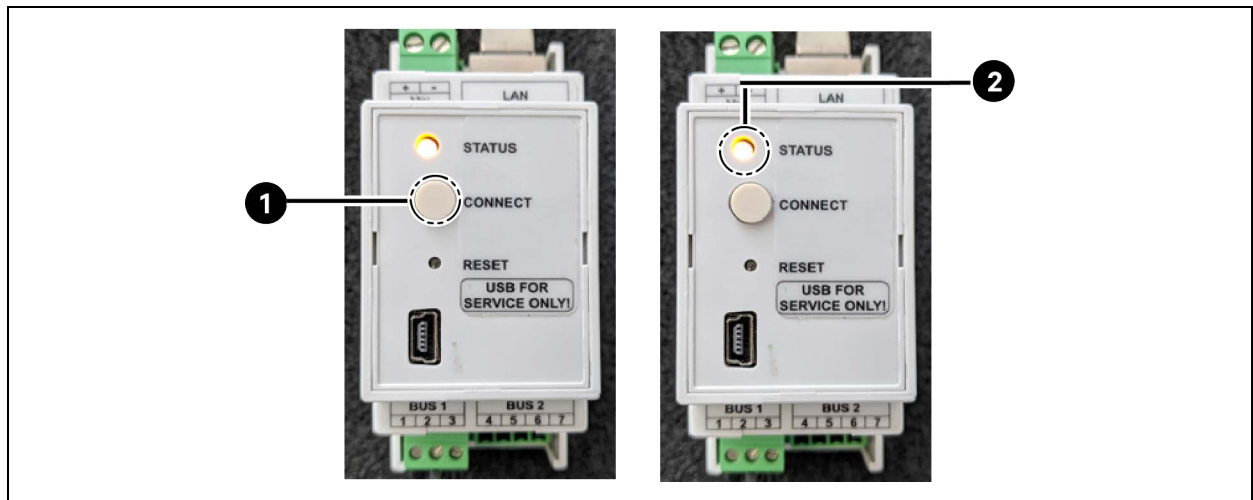

Item	Description
1	CONNECT Button
2	STATUS LED

5. After that the default values are active:
 - IP: 192.168.1.35
 - Gateway: 192.168.1.1
 - DHCP off
 - Modbus ID 1

NOTE: These values are not saved and are only temporarily set. If you have not set any new parameters, the old values are active after the next reboot.

NOTE: The [Status]-LED indicates the states of the Modbus gateway:

Table 8.1 LED Status

LED Status	Description
Orange	<ul style="list-style-type: none"> Default settings are active. No Modbus response. 30 s after powering the device.
Red	<ul style="list-style-type: none"> No Modbus primary connected.
Green	<ul style="list-style-type: none"> Modbus primary connected.
Orange-Blinking	<ul style="list-style-type: none"> Modbus request received.

8.3 Data Points

This section contains the Modbus TCP data points for Vertiv™ Liebert® DCDactive. Some data points are read-only, others can be read and written. Please refer to **Table 8.2** on page 66 .

NOTICE

Some values are only present if the corresponding sensor or actor is not connect to the Liebert® DCDactive. If a value (e.g., a temperature) is not present, the corresponding Modbus registers read as 0xFFFF (hex).

NOTE: For teaching, only one sensor has to be connected. After teaching you must re-connect all other sensors.

Table 8.2 Readable Data Points

Register Type	Address	Length	Description	Example	Unit	Data Type
Input Register (4)	0	10	Identity including serial number	SDZ0006E22F123456789	-	2 char / reg (sw)
Input Register (4)	74	4	Operating Hours (years, days, hours, minutes)	00 0123 59	-	16 bit int
Input Register (4)	82	2	Exhaust temperature	24,6	°C / K	32 bit float (sw)
Input Register (4)	86	2	Exhaust temperature 1	24,9	°C / K	32 bit float (sw)
Input Register (4)	90	2	Exhaust temperature 2	24,3	°C / K	32 bit float (sw)
Input Register (4)	94	2	Exhaust temperature 3	24,7	°C / K	32 bit float (sw)
Input Register (4)	98	2	Exhaust temperature 4	24,5	°C / K	32 bit float (sw)
Input Register (4)	102	2	Cabinet temperature	27,5	°C / K	32 bit float (sw)
Input Register (4)	106	2	Cabinet temperature 1	27,3	°C / K	32 bit float (sw)

Table 8.2 Readable Data Points (continued)

Register Type	Address	Length	Description	Example	Unit	Data Type
Input Register (4)	110	2	Cabinet temperature 2	27,7	°C / K	32 bit float (sw)
Input Register (4)	114	2	Cabinet temperature 3	27,4	°C / K	32 bit float (sw)
Input Register (4)	118	2	Cabinet temperature 4	27,5	°C / K	32 bit float (sw)
Input Register (4)	122	2	Cool water valve temperature	15,1	°C / K	32 bit float (sw)
Input Register (4)	126	2	Cool water valve temperature set-point	15,0	°C / K	32 bit float (sw)
Input Register (4)	130	2	Cool water supply temperature	13,0	°C / K	32 bit float (sw)
Input Register (4)	134	2	Cool water return temperature	17,1	°C / K	32 bit float (sw)
Input Register (4)	138	2	Differential pressure	2,9	Pa	32 bit float (sw)
Input Register (4)	142	1	Set-point for pressure control: <ul style="list-style-type: none"> • 0 - Slight negative pressure • 1 - Neutral (0 Pa) • 2 - Slight overpressure 	1	-	16 bit int
Input Register (4)	146	1	Fan speed 1	840	rpm	16 bit int
Input Register (4)	150	1	Fan speed 2	900	rpm	16 bit int
Input Register (4)	154	1	Fan speed 3	1080	rpm	16 bit int
Input Register (4)	158	1	Fan speed 4	840	rpm	16 bit int
Input Register (4)	162	1	Valve position	20	%	16 bit int
Input Register (4)	166	2	Low alarm threshold for exhaust temperature	15,0	°C / K	32 bit float (sw)
Input Register (4)	170	2	High alarm threshold for exhaust temperature	35,0	°C / K	32 bit float (sw)
Input Register (4)	174	2	Low alarm threshold for cabinet temperature	15,0	°C / K	32 bit float (sw)
Input Register (4)	178	2	High alarm threshold for cabinet temperature	35,0	°C / K	32 bit float (sw)
Input Register (4)	182	2	Low alarm threshold for cool water temperature	10,0	°C / K	32 bit float (sw)

Table 8.2 Readable Data Points (continued)

Register Type	Address	Length	Description	Example	Unit	Data Type
Input Register (4)	186	2	High alarm threshold for cool water temperature	30,0	°C / K	32 bit float (sw)
Input Register (4)	190	2	High value for temperature regulation curve	34,0	°C / K	32 bit float (sw)
Input Register (4)	194	2	Low value for temperature regulation curve	22,5	°C / K	32 bit float (sw)
Input Register (4)	198	2	Fan speed limit low	17	%	16 bit int
Input Register (4)	202	2	Fan speed limit high	100	%	16 bit int
Input Register (4)	206	2	Status door switch: <ul style="list-style-type: none"> • 0-Not installed, 1-Installed • 0-Closed, 1-Open 	1 0		16 bit int
Input Register (4)	210	2	Status leakage detection: <ul style="list-style-type: none"> • 0-Not installed, 1-Installed • 0-No water, 1-Water detect) 	1 0		16 bit int
Input Register (4)	214	1	Status cool water valve: <ul style="list-style-type: none"> • 0-Not installed, 1-Installed 	1		16 bit int
Input Register (4)	218	1	DCD Type: <ul style="list-style-type: none"> • 35 – DCD35 • 50 – DCD50 	35		16 bit int
Input Register (4)	222	1	Temperature unit (C, F)	C		char
Input Register (4)	226	1	Valve setting for leakage detection: <ul style="list-style-type: none"> • 0-Closed • 1-Neutral • 2-Open 	0		16 bit int
Input Register (4)	230	1	Reference value for regulation: <ul style="list-style-type: none"> • 0 – Cabinet temperature • 1 – Differential pressure 	0		16 bit int
Input Register (4)	234	1	Temperature for regulation: <ul style="list-style-type: none"> • 0 - Highest • 1 - Average 	0		16 bit int

8.4 Writeable Data Points

Table 8.3 Writeable Data Points

Register Type	Address	Length	Description	Example	Unit	Data Type
Write Multiple Register (16)	126	2	Cool water valve temperature Set-point	15,0	°C / K	32 bit float (sw)
Write Multiple Register (16)	142	1	Set-point for pressure control: <ul style="list-style-type: none"> • 0 - Slight negative pressure • 1 - Neutral (0 Pa) • 2 - Slight overpressure 	1	-	16 bit int
Write Multiple Register (16)	166	2	Low alarm threshold for exhaust temperature	15,0	°C / K	32 bit float (sw)
Write Multiple Register (16)	170	2	High alarm threshold for exhaust temperature	35,0	°C / K	32 bit float (sw)
Write Multiple Register (16)	174	2	Low alarm threshold for cabinet temperature	15,0	°C / K	32 bit float (sw)
Write Multiple Register (16)	178	2	High alarm threshold for cabinet temperature	35,0	°C / K	32 bit float (sw)
Write Multiple Register (16)	182	2	Low alarm threshold for cool water temperature	10,0	°C / K	32 bit float (sw)
Write Multiple Register (16)	186	2	High alarm threshold for cool water temperature	30,0	°C / K	32 bit float (sw)
Write Multiple Register (16)	190	2	High value for temperature regulation curve	34,0	°C / K	32 bit float (sw)
Write Multiple Register (16)	194	2	Low value for temperature regulation curve	22,5	°C / K	32 bit float (sw)
Write Multiple Register (16)	198	2	Fan speed limit low	17	%	16 bit int
Write Multiple Register (16)	202	2	Fan speed limit high	100	%	16 bit int
Write Multiple Register (16)	222	1	Temperature unit (C, F)	C		char
Write Multiple Register (16)	226	1	Valve setting for leakage detection: <ul style="list-style-type: none"> • 0-Closed • 1-Neutral • 2-Open 	0		16 bit int
Write Multiple Register (16)	230	1	Reference value for regulation: <ul style="list-style-type: none"> • 0 - Cabinet temperature • 1 - Differential pressure 	0		16 bit int
Write Multiple Register (16)	234	1	Temperature for regulation: <ul style="list-style-type: none"> • 0 - Highest • 1 - Average 	0		16 bit int

This page intentionally left blank

9 Water Flow Modulating Valve

The return temperature controller is a pre-assembled unit consisting of a 2-way control ball valve, an attached actuator with spring return and an electronic control box with connected temperature sensor. The electrical connection is made with a cold-unit connector. The volume flow of the medium is adjusted with the control ball valve via the actuator so that the desired return temperature is set. The control action is such that the volume flow is increased if the measured temperature is above the set-point.

The temperature set-point can be set on the unit display of the Vertiv™ Liebert® DCDactive or via the Modbus TCP/IP interface. The current medium temperature and the position of the control ball valve can be called up on the Liebert® DCDactive display or via Modbus TCP/IP. The operating status of the unit is indicated by a LED in the control box behind the clear housing cover. As an option, the operating status can be picked up and forwarded to a signalling contact.

After correct connection and switching on the voltage, the Liebert® DCDactive automatically recognises the controller and starts to control the medium temperature. If the bus connection between the Liebert® DCDactive and controller is disconnected during operation, the controller moves the valve to the open position after a short time. Due to the actuator's spring return, the open position is reliably approached even in the event of voltage loss or a cable break.

9.1 Connections

Table 9.1

Connection	Designation	Description
X1	Mains	Supply voltage connection (provided).
X2	Bus	Connection for the Liebert® DCDactive.
X3	Signalling contact	Connection for external evaluation of the signalling contact (optional).

Figure 9.1 Side View with Designation of the Connections and Flow Direction Arrows

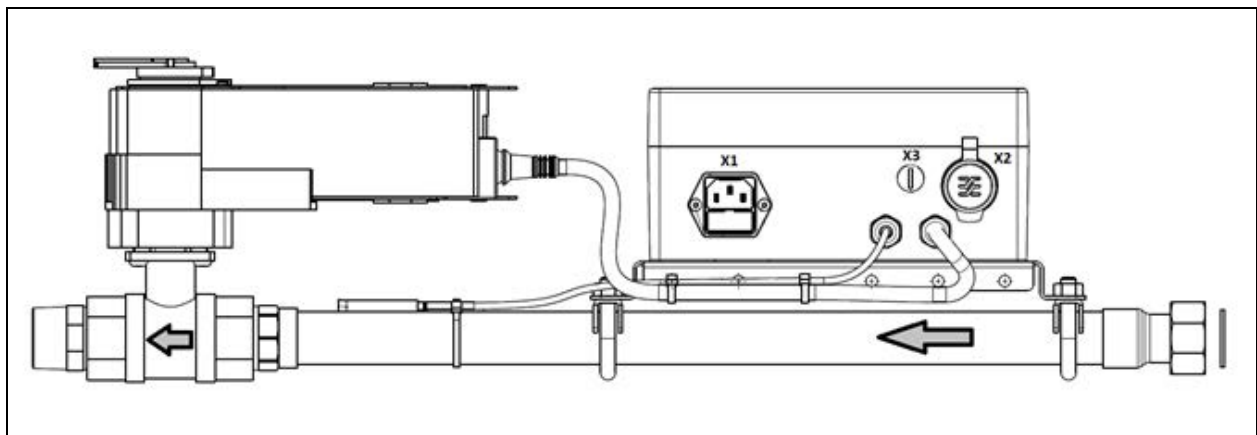

Figure 9.1 above shows the Side View with Designation of the Connections and Flow Direction Arrows of the Medium from the Inlet (Union Nut) to the Outlet (External Thread).

9.2 Technical Data

Table 9.2 Technical Data

Parameters	Description
Supply Voltage Connection	
Operating voltage	85-264 Vac, 47-63 Hz
Supply voltage	Max. 8 W
Fuse	2 AT (type 5 x 20, in the C14 built-in plug connection)
Connection	C14 (cold-unit connector)
Signalling Contact	
Type	Relay, change-over contact, potential-free, internal terminal bar
Contact	16 Adc @ 30 Vdc, 0.3 Adc @ 110 Vdc, 16 Aac @ 250 Vac
Dielectric strength	4 kVac (contact - coil)
Control	
Control range	5-40°C (+40 to +104°F)
Accuracy (static)	± 0.5 K
Actuator	
Torque	At least 10 Nm (7.37 ft-lbf)
Duration	90 s / 90°(emergency control function < 20 s / 90°)
Emergency control function	Spring return
Control Ball Valve	
Type	2-way ball
Kvs value	6.3 m³/h (27.7 gpm)
Pressure range	Max. 1600 kPa (232 psi)
Differential pressure	Max. 350 kPa (50.8 psi)
Medium	Cold & warm water glycol up to max. 50% vol.
Medium temperature	-10 to +120°C (+14 to +248F)
Housing material	Nickel-plated brass
Characteristic line	Equal percentage
Angle of rotation	90°; (15-90)°
Mechanical Data	
Dimensions (L x W x H)	620 x 130 x 170 mm (24.41 x 5.12 x 6.69 in)
Weight	Approx. 4.5 kg (9.92 lb)
Dimensions of electronics (L x W x H)	200 x 120 x 91 mm (7.87 x 4.72 x 3.58 in)
Protection class	IP40
Degree of pollution	2
Input assembly	IG union nut RG 1"

Table 9.2 Technical Data (continued)

Parameters	Description
Output assembly	AG R 1"
Top/bottom installation distance	100 mm (3.94 in)
Lateral installation distance	50 mm (1.97 in)
Environmental Conditions	
Operating temperature	-25 to +40°C (-13 to +104°F)
Storage temperature	-40 to +80°C (-40 to +176°F)
Ambient humidity	0 - 95 %, no condensation

9.3 Installation Instructions

NOTICE

The ball valve can be installed vertically or horizontally (all sides). It is not permitted to install the ball valve suspended, i.e. with the stem pointing downwards.

Figure 9.2 Permissible Mounting Positions

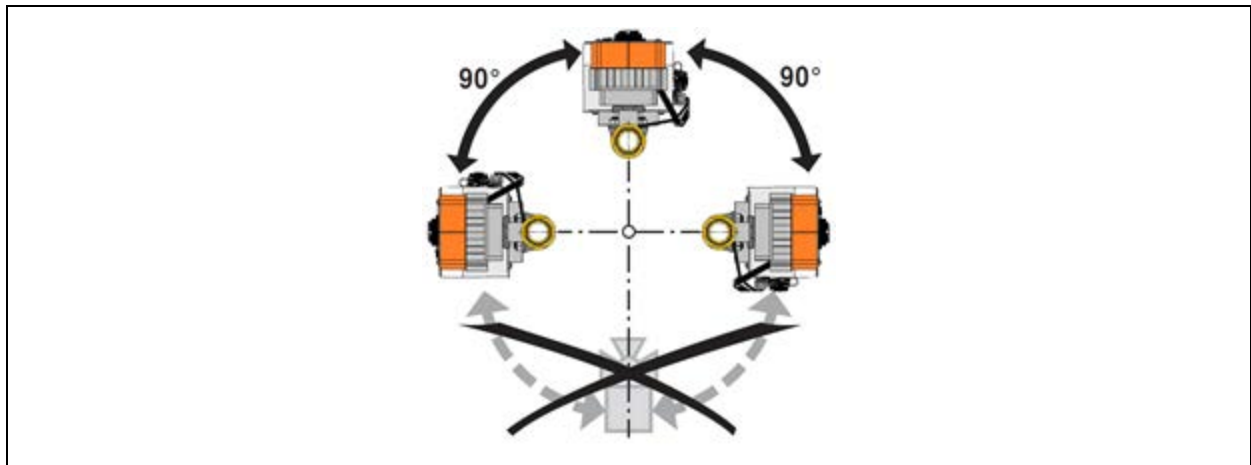

9.4 Dimensions

Figure 9.3 Dimensions

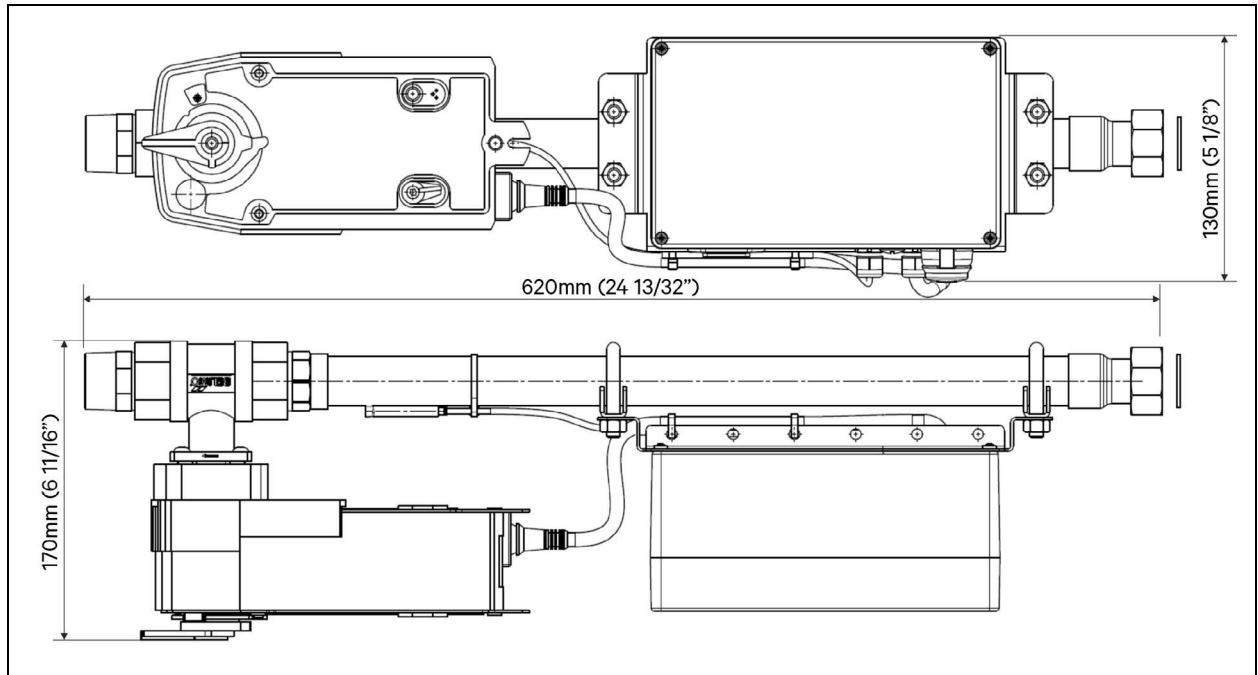

10 Spare Parts List

Table 10.1 Spare Parts List

Order Number	Description	
08.014.581.0	Fan Liebert® DCD 35 Active Module	
08.015.581.0	Fan Liebert® DCD 50 Active Module	
08.014.582.0	Power Supply Liebert® DCDactive	

Table 10.1 Spare Parts List (continued)

Order Number	Description	Image
08.014.583.0	Internal Temperature-Sensor Liebert® DC Dactive	 <p>A black cable with a metal probe at one end and three colored wires (red, yellow, blue) at the other, coiled on a light blue background.</p>
SN-T	Cabinet Temperature Sensor Liebert® DC Dactive	 <p>A black, rectangular plastic sensor module with a handle on top and a connector on the side, shown in a 3D perspective view.</p>
08.014.584.0	Connecting cable Liebert® DC Dactive C14-Wieland	 <p>A grey cable with two black connectors, one of which is a C14 connector, coiled on a light blue background.</p>

Table 10.1 Spare Parts List (continued)

Order Number	Description	
08.014.585.0	Controller Liebert® DCD 35 Active	 A black printed circuit board (PCB) with various electronic components. It features two long green terminal blocks on the left and right sides, a central microcontroller chip, and several other integrated circuits and passive components. A small black component is visible near the top right corner.
08.014.585.5	Controller Liebert® DCD 50 Active	 A black printed circuit board (PCB) similar to the one above, but with a different component configuration. It features two long green terminal blocks on the left and right sides, a central microcontroller chip, and several other integrated circuits and passive components. A small black component is visible near the top right corner.
08.014.586.0	Pressure sensor hose Liebert® DCDactive	 A blue, flexible, circular hose or cable, likely made of plastic or rubber, used for connecting a pressure sensor.

Table 10.1 Spare Parts List (continued)



Order Number	Description	
08.014.587.0	TFT-Display Liebert® DCD 35 Active	
08.014.587.5	TFT-Display Liebert® DCD 50 Active	
08.014.588.0	A/B Transfer Switch 110V Liebert® DCDactive	
08.014.589.0	A/B Transfer Switch 230V Liebert® DCDactive	

Table 10.1 Spare Parts List (continued)

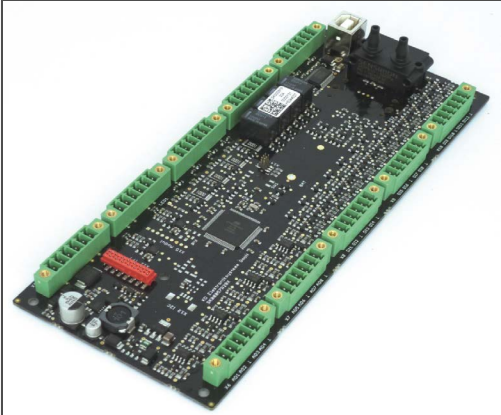
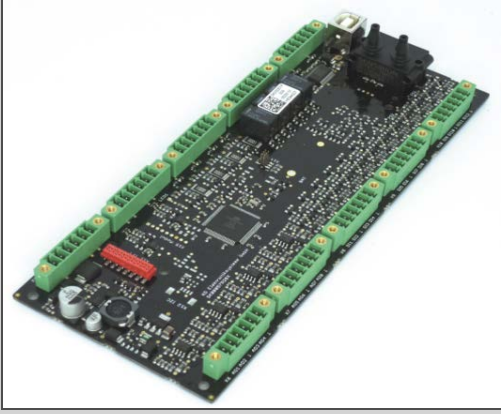
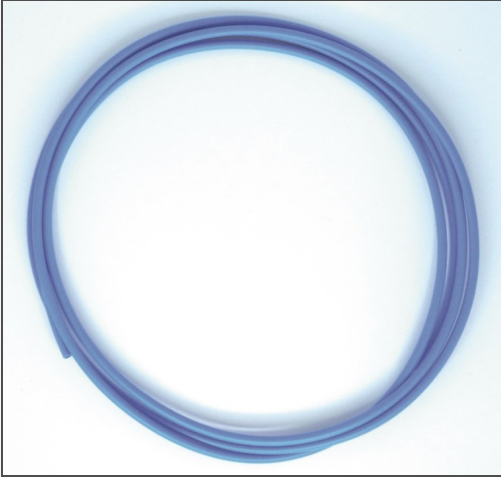
Order Number	Description	
08.014.580.8	Cover Panel Liebert® DCD35 Active RAL7021 (1)	
08.014.580.1	Cover Panel Liebert® DCD35 Active RAL7035 (2)	
08.015.580.8	Cover Panel Liebert® DCD50 Active RAL7021 (1)	
08.015.580.1	Cover Panel Liebert® DCD50 Active RAL7035 (2)	
08.014.592.0	Gateway ModBus TCP/IP Liebert® DCDActive	

This page intentionally left blank

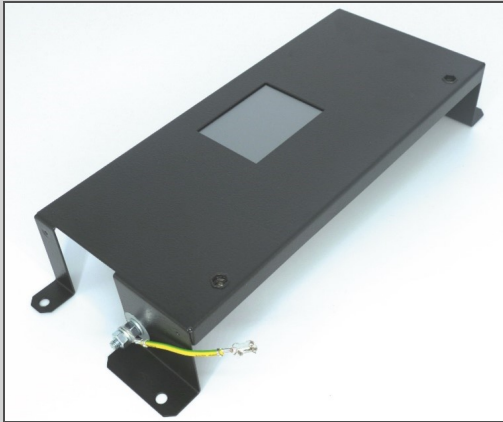
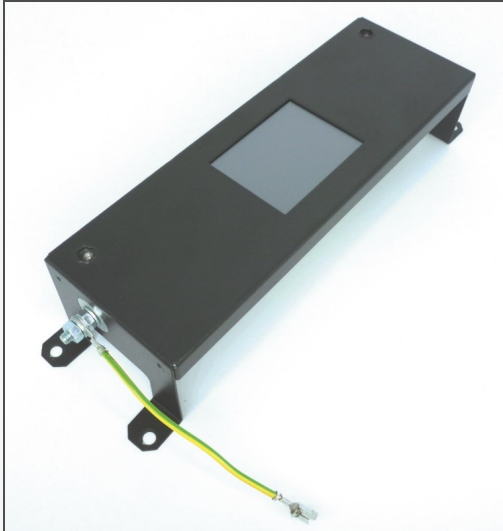
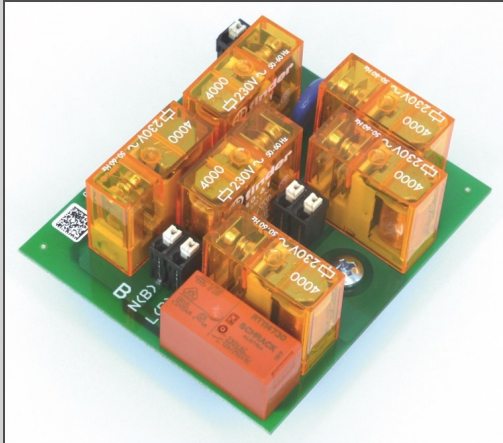
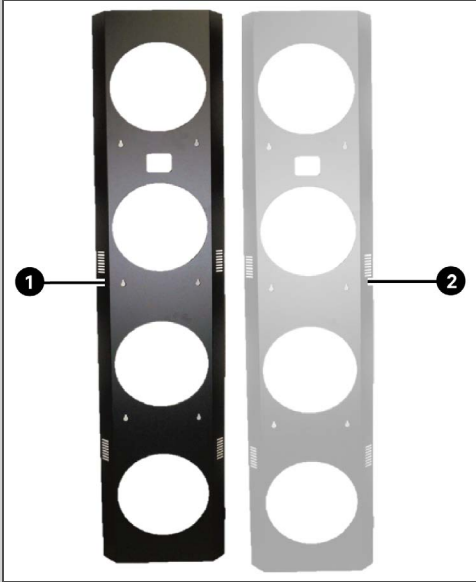
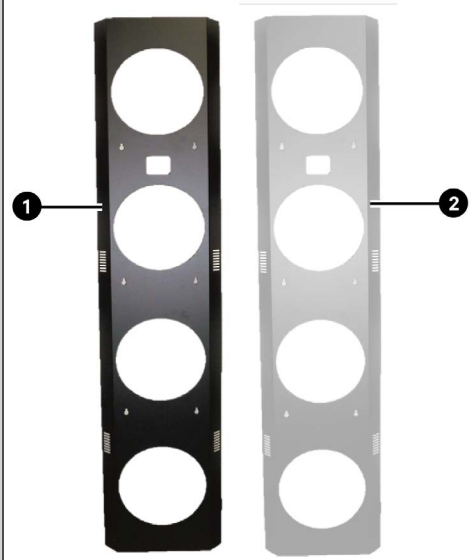
Connect with Vertiv on Social Media



<https://www.facebook.com/vertiv/>



<https://www.instagram.com/vertiv/>



<https://www.linkedin.com/company/vertiv/>



<https://www.twitter.com/Vertiv/>



Vertiv.com | Vertiv Headquarters, 505 N. Cleveland Ave., Westerville, OH 43082, USA

© 2024 Vertiv Group Corp. All rights reserved. Vertiv™ and the Vertiv logo are trademarks or registered trademarks of Vertiv Group Corp. All other names and logos referred to are trade names, trademarks or registered trademarks of their respective owners. While every precaution has been taken to ensure accuracy and completeness here, Vertiv Group Corp. assumes no responsibility, and disclaims all liability, for damages resulting from use of this information or for any errors or omissions.

SL-70835_REVB_02-24