



# DC/DC Converter Module

## User Manual

Specification Number: 1C48241500

Model Number: C48/24-1500

The information contained in this document is subject to change without notice and may not be suitable for all applications. While every precaution has been taken to ensure the accuracy and completeness of this document, Vertiv assumes no responsibility and disclaims all liability for damages resulting from use of this information or for any errors or omissions. Refer to other local practices or building codes as applicable for the correct methods, tools, and materials to be used in performing procedures not specifically described in this document.

The products covered by this instruction manual are manufactured and/or sold by Vertiv. This document is the property of Vertiv and contains confidential and proprietary information owned by Vertiv. Any copying, use or disclosure of it without the written permission of Vertiv is strictly prohibited.

Names of companies and products are trademarks or registered trademarks of the respective companies. Any questions regarding usage of trademark names should be directed to the original manufacturer.

### **Technical Support Site**

If you encounter any installation or operational issues with your product, check the pertinent section of this manual to see if the issue can be resolved by following outlined procedures.

Visit <https://www.vertiv.com/en-us/support/> for additional assistance.

## TABLE OF CONTENTS

<b>Admonishments Used in this Document</b> .....	<b>iv</b>
<b>Important Safety Instructions</b> .....	<b>v</b>
Safety Admonishments Definitions.....	v
Safety and Regulatory Statements.....	v
Déclarations de Sécurité et de Réglementation.....	v
<b>1 Introduction</b> .....	<b>1</b>
1.1 Overview.....	1
1.2 Specifications.....	1
<b>2 Operation</b> .....	<b>5</b>
2.1 Local Indicators .....	5
2.2 Converter High Voltage Shutdown and Lockout Restart.....	5
2.3 Converter Current Limit.....	5
2.4 Installing Converter Modules.....	6
<b>3 Troubleshooting and Repair</b> .....	<b>7</b>
3.1 Troubleshooting.....	7
3.2 Replacement Procedures.....	8

## Admonishments Used in this Document



**DANGER!** Warns of a hazard the reader *will* be exposed to that will *likely* result in death or serious injury if not avoided. (ANSI, OSHA)



**WARNING!** Warns of a potential hazard the reader *may* be exposed to that *could* result in death or serious injury if not avoided. This admonition is not used for situations that pose a risk only to equipment, software, data, or service. (ANSI)



**CAUTION!** Warns of a potential hazard the reader *may* be exposed to that *could* result in minor or moderate injury if not avoided. (ANSI, OSHA) This admonition is not used for situations that pose a risk only to equipment, data, or service, even if such use appears to be permitted in some of the applicable standards. (OSHA)



**ALERT!** Alerts the reader to an action that *must be avoided* in order to protect equipment, software, data, or service. (ISO)



**ALERT!** Alerts the reader to an action that *must be performed* in order to prevent equipment damage, software corruption, data loss, or service interruption. (ISO)



**FIRE SAFETY!** Informs the reader of fire safety information, reminders, precautions, or policies, or of the locations of fire-fighting and fire-safety equipment. (ISO)



**SAFETY!** Informs the reader of general safety information, reminders, precautions, or policies not related to a particular source of hazard or to fire safety. (ISO, ANSI, OSHA)

# **Important Safety Instructions**

## **Safety Admonishments Definitions**

Definitions of the safety admonishments used in this document are listed under “Admonishments Used in this Document” on page iv.

## **Safety and Regulatory Statements**

Refer to Section 4154 (provided with your customer documentation) for Safety and Regulatory Statements.

## **Déclarations de Sécurité et de Réglementation**

Reportez-vous à la Section 4154 (fourni avec les documents de votre client) pour les déclarations de sécurité et de réglementation.

This page intentionally left blank.

# 1 Introduction

## 1.1 Overview

The Vertiv™ C48/24-1500 is a compact DC/DC converter which offers efficient power conversion. It operates from a nominal -48 VDC source to provide nominal +24 VDC load power.

## 1.2 Specifications

### 1.2.1 DC Output Ratings

- Voltage: Nominal +24 volts DC, negative ground. Output voltage is adjustable from 24 to 28 volts DC via the associated controller.
- Nameplate Rating: 24 to 28 VDC, 1500W.
- Regulation:
  - a) Output Voltage Tolerance:  $< \pm 0.2\%$  when the load is 50% and the temperature is from +15 to +35°C;  $< \pm 0.5\%$  when the load is 50% and the temperature is from -5 to +55°C;  $< \pm 1\%$  when the load is 50% and the temperature is from -20 to +55°C.
  - b) Temperature Regulation:  $< \pm 0.02\%$  when the load is 50% at -48 VDC and temperature range is from -10°C to +55°C.
  - c) Dynamic Response: The dynamic response time at rated input and output voltage is  $\leq 200\mu\text{s}$  and overshoot  $\leq 5\%$  for load changes at 50%-25%-50% and 50%-75%-50%.
  - d) The output voltage is accurate at half load. At half load, the error of output voltage is  $\leq \pm 100\text{mV}$ . Static regulation will give other voltage depending on load. The default value at half load is 27 VDC.
- Filtering:
  - a) Peak-peak voltage is  $\leq 250\text{mV}$  at 1-100MHz and normal output voltage.
  - b) Psophemetic noise voltage is  $\leq 2\text{mV}$  between 5-100% of the maximum load (output voltage  $> 24$  VDC).
  - c) Wideband noise is  $< 20\text{mV rms}$  between 25HZ-20kHz (test according to ETS300132).
  - d) Output noise according to Telcordia GR-947-CORE:  $< 38$  dBrnC (between 5-100% of the maximum load, output voltage  $> 24$  VDC).
- Ripple Attenuation: Ripple attenuation is better than +24dB, input to output and  $f < 360\text{Hz}$ .

### 1.2.2 DC Input Ratings

- Voltage: Nominal -48 volts DC.
- Nameplate Rating: -41 to -58.5 VDC, 39.5A max.
- Inrush Current: The peak value of the inrush current does not exceed 2 times the maximum steady-state peak value.
- Input Regulation:  $\leq \pm 0.1\%$  when the load is 100% at -42 to -58.5 VDC input and temperature is +25°C.
- Temperature Coefficient:  $\leq \pm 0.02\%/^{\circ}\text{C}$  over the specified operating temperature range.
- Typical Input Data: When equipped with one DC-DC converter.
  - a) See Table 1.1.

- b) Maximum Current: Input current is 39.5 amperes at -41.0 volts DC input and full load.

**Table 1.1 Typical Input Data**

Input Voltage	Percent of Full Load	Input Current (Amps)	Efficiency (%)	Typical Heat Dissipation (BTU/Hr)
42 VDC	0	0.125	--	18.02
	25	9.388	95.661	58.28
	50	18.803	95.416	122.84
	75	28.714	94.217	235.77
	100	38.888	92.835	394.06
48 VDC	0	0.122	--	20.02
	25	8.218	95.516	60.33
	50	16.431	95.336	125.12
	75	25.055	94.181	237.34
	100	33.887	92.800	396.04
58 VDC	0	0.105	--	20.93
	25	6.811	95.286	63.55
	50	13.601	95.141	130.57
	75	20.713	94.049	243.05
	100	27.987	92.689	402.69



**NOTE!** The output voltage of the DC-DC converter is initially adjusted to 24 volts DC at 50% load and 48 volts DC input.

### 1.2.3 Environmental Ratings

- Operation Temperature Range: -40°C to +80°C (-40°F to +176°F), -20°C to +55°C (-4°F to +131°F) with full performance.
- Storage Ambient Temperature Range: -40°C to +70°C (-40°F to +158°F).
- Humidity: This converter is capable of operating in an ambient relative humidity range of 0 to 90%, non-condensing.
- Altitude: The maximum operating ambient temperature should be derated by 3°C per 1000 feet at an elevation of 6,000 feet.
- Ventilation Requirements: The converter is fan cooled and utilizes front to back forced ventilation.
- Audible Noise: With a single converter installed and operating, the audible noise measured in front of converter at a 0.6m distance from a horizontal line from the middle of converter does not exceed 50 dBA with a temperature of 25°C.
- Over Voltage Category: II.
- Power Distribution System: TN/TT/IT.



**NOTE!** The converter is recommended to be used in an environment with Pollution of Degree 2 or less. Pollution Degree 2 applies where there is only non-conductive pollution that might temporarily become conductive due to occasional condensation (such as the office environment).

### 1.2.4 Compliance Information

- Safety Compliance: This unit meets the requirements of UL 60950-1, Standard for Information Technology Equipment, and is UL Recognized as a power supply for use in Telephone, Electronic Data Processing or Information Processing Equipment.



- EMC: This unit meets EN300 386 V1.51, Class A, other than Telecom centers.
- EFT: This unit meets EN61000-4-4, EFT will be fulfilled for DC terminals at 4KV (CM) with criteria B and signal line at 1KV (CM) with criteria B.
- ESD: This unit meets EN61000-4-2; requirements are 6KV contact and 8KV air for criteria B and 8KV/15KV for criteria C.
- Radiated Electrical Fields: This unit meets EN61000-4-3. 10V/m in the frequency range 80MHZ-1GHz and 1.4-2GHz with criteria A will be fulfilled.
- Power Frequency Magnetic Field: This unit meets EN61000-4-8. 30A/m magnetic field at 50Hz will be fulfilled for criteria A.
- Radiated Emission: For electrical field, meets EN55022 Class A between 150KHZ-30MHZ. For a standalone converter the levels are 6db below the class A limits.
- Climatic Environment:
  - a) Transportation: Meets ETS 300 019-1-2, Class 2.3.
  - b) Storage and Handling: Meets ETS 300 019-1-1, Class 1.2.
  - c) Operation: Meets ETS 300 019-1-3, Class 3.2.
  - d) Transportation, Storage and Handling, Operation: Meets Telcordia GR-63-Core, Chapter 4.
- GR-3108 Class 2 Compliant

## 1.2.5 Standard Features

- Type of Power Conversion Circuit: High Frequency.
- Input Voltage Protection:
  - a) Fusing: A non-user replaceable fuse is located in the positive input lead of each DC-DC converter.
  - b) High and Low Input Voltage Inhibit: The converter shuts down at low or high input voltage.
    1. Low Voltage Disable Point: -40.0 VDC  $\pm$ 0.5 VDC; hysteretic at least 3 VDC for restart.
    2. High Voltage Disable Point: 59.5 VDC  $\pm$ 0.5 VDC; hysteretic at least 2 VDC for start.
- Output Protection:
  - a) Overvoltage Protection: When output voltage goes above a preset value (30.5 $\pm$ 0.5V, not to exceed 31V for more than 150ms), the converter shuts down. Software settable HVSD level (from controller) 27V-30V.
  - b) Power Limit: Output power is limited to 1500W.
  - c) Over Temperature Protection: The operation of a DC-DC converter will automatically shut down and lock out if the internal temperature of the module exceeds a predetermined value. Operation will automatically resume after the over-temperature condition is corrected.
- Series Paralleling Output FET: A series paralleling output FET is provided in each DC-DC converter. This allows the modules to be paralleled for redundancy.
- Hot Swappable: The converter is designed to be plug-and-play. The converter can be inserted or removed from a live DC power system with no damage. When the converter is plugged into the system, the sub-system output voltage will not be affected.

- **Cooling:** Each converter contains a fan for forced convection cooling.
  - a) **Fan Fault Protection:** The converter shuts down and its alarm indicator (red) flashes if the fan fails. Fan failure is detected and reported to controller. The fan is not field replaceable.
  - b) **Fan Control:** Fan speed is continuously variable. When input voltage is within normal range, the built-in processor adjusts fan speed according to the converter’s output power. For example, a higher output power increases the fan speed.
- **Communication Failure:** The protection indicator (yellow) will flash should communication between the converter and associated system controller fail. The failure information will be reported to the associated system controller and the controller will process the failure accordingly. During a communication failure, the converter output voltage will automatically adjust to 24.00 VDC. The converter will revert to normal operation once normal communication is restored.
- **Monitoring Function:** The converter has a built-in advanced DSP (Digital Signal Processor) that monitors and controls the operation of the converter. The DSP also communicates with the associated system controller in real time through the CAN bus. Table 1.2 lists the different commands and information exchanged between the converter and the controller.
- **External Alarm:** Provided via the associated controller. Refer to the separate Power System documentation for a description of available external alarms.

**Table 1.2 Monitoring Function**

Commands / signals that can be received by the Converter Module from the Controller.	Information gathered by the Controller from the Converter Module.
<ul style="list-style-type: none"> <li>• Turn On/Off</li> <li>• HVSD Reset</li> <li>• Current Limit Adjustment</li> <li>• Voltage Adjustment</li> <li>• Fan Speed Control Enable/Disable</li> <li>• HVSD Threshold</li> </ul>	<ul style="list-style-type: none"> <li>• Output Voltage</li> <li>• Output Current</li> <li>• Current Limit Setting</li> <li>• Temperature</li> <li>• Over Voltage Setting</li> <li>• On/Off Status</li> <li>• Fault Alarms, such as:                             <ul style="list-style-type: none"> <li>HVSD</li> <li>Fan Fail</li> </ul> </li> <li>• EEPROM Failure</li> <li>• Protection Alarms, such as:                             <ul style="list-style-type: none"> <li>Input Voltage Protection</li> <li>High Temperature Protection</li> </ul> </li> <li>• Thermal Derating</li> <li>• Address</li> <li>• Code</li> <li>• Date</li> <li>• Software Version</li> <li>• Hardware Version</li> <li>• Imbalance Output Current</li> </ul>

### 1.2.6 Mechanical Specifications

- **Weight:** 1.13kg (2.49 lbs).
- **Dimensions (H x W x D):** 1.65” (42mm) x 3.33” (84.5mm) x 10.2” (260mm).
- **Local Controls:** None.

- Local Status and Alarm Indicators:
  - a) Power (Green)
  - b) Protection (Yellow)
  - c) Alarm (Red)

## 2 Operation

### 2.1 Local Indicators

Location and Identification: Refer to Figure 2.1.

Description: There are three (3) indicators located on the converter's front panel. The functions of these indicators are as shown in Table 2.1.



**NOTE!** DC voltage must be present at the converter output terminals (from battery or an operating converter) or DC voltage at the input terminals.

### 2.2 Converter High Voltage Shutdown and Lockout Restart

#### **Procedure**

Remove the converter, wait 30 seconds or more (until the LEDs on the converter extinguish), then re-insert the converter.

The converter may also be restarted from the controller. Refer to the controller's documentation.



### 2.3 Converter Current Limit

When setting total converter current limit, the set point to each converter is the total set point divided by the number of converters. For example, if the system contains five converters and the current limit is set to 150 amps then each converter has a current limit set point of 30 amps. If one or more converters are removed or fail it will take several seconds for the individual set points to the remaining converters to be reset. In the example given, if one converter is removed the current limit set point will drop to 120 amps (30 amps times four remaining converters) until the controller can send updated set points to the remaining converters. This takes a couple communication cycles (several seconds) after which each converter would have a new set point of 37.5 amps for a total of 150 amps. The total current limit of the converters should not be set such that the loss of the redundant converters will cause this temporary set point to drop below the actual maximum expected load.

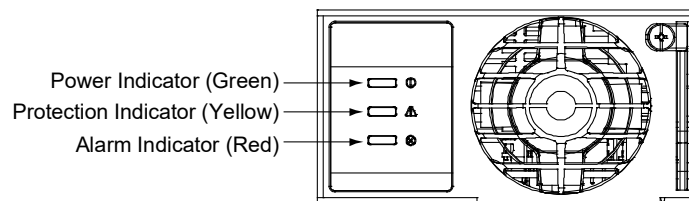
**Figure 2.1 Local Indicator Locations**



**Table 2.1 DC-DC Converter Indicators**

Indicator		Normal State	Alarm State	Alarm Cause
	Power (Green)	On	Off	No input voltage. Internal input fuse open.
			Flashing	The converter is being identified by the controller.
	Protection (Yellow)	Off	On	DC input under/over voltage. Moderate load sharing imbalance. Converter not inserted into the slot completely. Converter over-temperature protection. Converter in ECO Standby Mode when ECO Mode is active in controller.
			Flashing	Loss of communication with the controller (the converter can provide power).
	Alarm (Red)	Off	On	Severe load sharing imbalance. Converter output disabled for any reason, including overvoltage shutdown. Converter addresses contradictory.
			Flashing	Faulty fan (converter shuts down).

## 2.4 Installing Converter Modules

Converters can be inserted or removed with power applied (hot swappable).



**NOTE!** Each converter locks into a module mounting shelf by means of a latch located on the bottom of the module. The latch and converter handle are interactive. Pushing the handle up into the module's front panel causes the latch to extend to the locking position; pulling the handle down out from the module's front panel causes the latch to retract. See Figure 2.2.



**CAUTION!** This converter contains Double pole/Neutral fusing; parts of the equipment that remain energized might represent a hazard during servicing after operation of the fuse.



**WARNING!** To prevent damage to the latching mechanism, ensure the handle is in the open position when installing or removing a converter. NEVER hold the handle in the closed position when installing a converter into a shelf.

### Procedure



**NOTE!** Refer to Figure 2.2 as this procedure is performed.

1. Unpack the module.
2. Place the module into an unoccupied mounting slot without sliding it in completely.
3. Loosen the captive screw on the module's handle. Pull the handle down out from the module's front panel (this will also retract the latch mechanism). See Figure 2.2.
4. Push the module completely into the shelf.
5. Push the handle up into the module's front panel. This will lock the module securely to the shelf. Tighten the captive screw on the handle.
6. Repeat the above steps for each converter being installed in the system.

7. After the converters are physically installed in the mounting shelf(s), they are ready for operation immediately after power is supplied to them.
8. Certain functions (i.e. converter current limit, converter addressing) may require adjustment when adding or replacing a converter. Refer to “Converter Current Limit” on page 5 and the Power System documentation for instructions.

**Figure 2.2 Installing Converter Module**

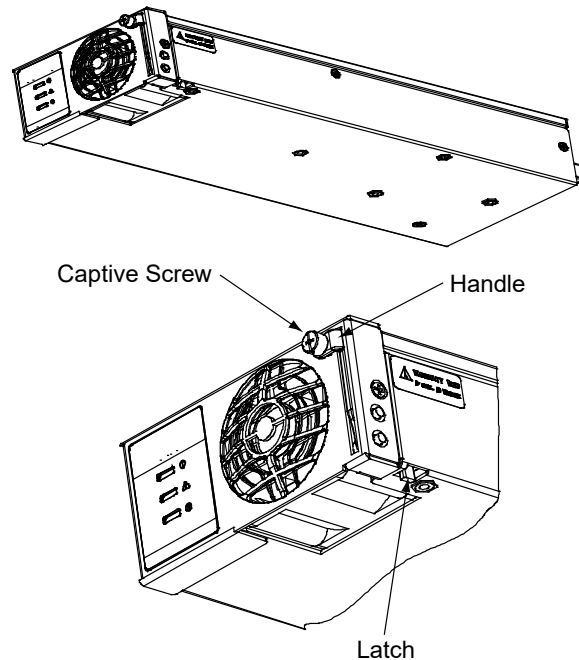

## 3 Troubleshooting and Repair

### 3.1 Troubleshooting

#### 3.1.1 Converter Module Current Sharing Imbalanced

When multiple converters are operating in parallel and the load is greater than 10%, if the current sharing imbalance among them is greater than 2A, check if the converter is properly seated in the shelf.

If the current sharing imbalance still persists following the verification suggested above, replace the converter exhibiting the current imbalance.



#### 3.1.2 Converter Module Fault Symptoms and Troubleshooting

The fault indicators that can be displayed by the converter are as follows.

Refer to Table 3.1 for a list of possible causes and corrective actions.

- Power Indicator (Green) OFF
- Protection Indicator (Yellow) ON
- Protection Indicator (Yellow) Flashing
- Alarm Indicator (Red) ON
- Alarm Indicator (Red) Flashing

**Table 3.1 Converter Module Troubleshooting**

Symptom		Possible Cause(s)	Suggested Action(s)
	Power Indicator (Green) Off	No input voltage.	Make sure there is input voltage.
		Internal input fuse open.	Replace the converter.
	Protection Indicator (Yellow) On	DC input under/over voltage.	Correct the DC input voltage to within the acceptable range.
		Moderate load sharing imbalance.	Check if the converter is properly seated in the shelf. If this does not correct the fault, replace the converter.
		Converter not inserted into the slot completely.	Remove and properly insert the converter.
		Converter over-temperature protection.	Fan rotor blocked: remove any object that may be blocking the fan. Ventilation blocked (inlet or outlet): remove any object that may be blocking the inlet or outlet. Ambient temperature too high or rectifier inlet too close to a heat source: lower the ambient temperature or relocate the heat source.
	Protection Indicator (Yellow) Flashing	Loss of communication with controller (the converter can provide power).	Check the communication cables. Remove and properly insert the converter.
	Alarm Indicator (Red) On	Severe load sharing imbalance. Converter output disabled for any reason, including overvoltage shutdown.	Remove the converter, wait 30 seconds or more (until the LEDs on the converter extinguish), then re-insert the converter. If converter fails to start, shuts down again, or load sharing imbalance persists; replace the converter.
		Converter addresses contradictory.	Replace the converter.
	Alarm Indicator (Red) Flashing	Fan not operating (converter shuts down).	Replace the converter.

## 3.2 Replacement Procedures

### 3.2.1 Converter Module Replacement

Converters can be inserted or removed with power applied (hot swappable).



**NOTE!** Each converter locks into a module mounting shelf by means of a latch located on the bottom of the module. The latch and converter handle are interactive. Pushing the handle up into the module's front panel causes the latch to extend to the locking position; pulling the handle down out from the module's front panel causes the latch to retract. See Figure 2.2.



**DANGER!** Take care when removing a converter that was in operation, as converter surfaces could be very hot.



**WARNING!** To prevent damage to the latching mechanism, ensure the handle is in the open position when installing or removing a converter. NEVER hold the handle in the closed position when installing a converter into a shelf.

#### Procedure



**NOTE!** Refer to Figure 2.2 as this procedure is performed.

1. Performing this procedure may activate external alarms. Do one of the following. If possible, disable these alarms. If these alarms cannot be easily disabled, notify the appropriate personnel to disregard any alarms associated with this system while this procedure is performed.

2. Loosen the captive screw on the module's handle. Pull the handle down out from the module's front panel (this will also retract the latch mechanism). See Figure 2.2.
3. Grasp the handle and pull firmly to remove the module from the shelf.
4. Place the replacement converter into the mounting position without sliding it in completely.
5. Loosen the captive screw on the module's handle. Pull the handle down out from the module's front panel (this will also retract the latch mechanism). See Figure 2.2.
6. Push the module completely into the shelf.
7. Push the handle up into the module's front panel. This will lock the module securely to the shelf. Tighten the captive screw on the handle.
8. Certain functions (i.e. converter current limit, converter addressing) may require adjustment when adding or replacing a converter. Refer to "Converter Current Limit" on page 5 and the Power System documentation for instructions.
9. After the converters are physically installed in the mounting shelf(s), they are ready for operation immediately after power is supplied to them. Verify that the converters are operating normally.
10. Enable the external alarms, or notify appropriate personnel that this procedure is finished.
11. Ensure that there are no local or remote alarms active on the system.

This page intentionally left blank.



## Connect with Vertiv on Social Media



<https://www.facebook.com/vertiv/>



<https://www.instagram.com/vertiv/>



<https://www.linkedin.com/company/vertiv/>



<https://www.twitter.com/vertiv/>



---

Vertiv.com | Vertiv Headquarters, 1050 Dearborn Drive, Columbus, OH, 43085, USA

© 2022 Vertiv Group Corp. All rights reserved. Vertiv™ and the Vertiv logo are trademarks or registered trademarks of Vertiv Group Corp. All other names and logos referred to are trade names, trademarks or registered trademarks of their respective owners. While every precaution has been taken to ensure accuracy and completeness here, Vertiv Group Corp. assumes no responsibility, and disclaims all liability, for damages resulting from use of this information or for any errors or omissions. Specifications, rebates and other promotional offers are subject to change at Vertiv's sole discretion upon notice.