



VERTIV INTELLIGENT RACK PDU

VP8941, VP8641, VP5870V, VP5665V, VP8965, VP8932, VP8930,
VP4551V, VP8959NA3, VP8959EU3 and VP8953

[VertivCo.com/geist](https://www.vertivco.com/geist)

CONTENTS

1. Introduction.....	6
1.1. Welcome	6
2. About this Manual.....	9
2.1. Organization of the Manual.....	9
2.2. Audience Profile	9
2.3. On-line Documentation	9
2.4. Reporting Document Errors	10
2.5. Conventions	10
2.5.1. Software.....	10
2.5.2. Hardware	10
2.5.3. Safety.....	12
2.5.4. Figures.....	13
2.5.5. Tables	13
3. Chapter 1 - Product Specifications.....	14
3.1. Product Specifications	14
3.1.1. Overview.....	14
3.1.2. Environmental.....	15
3.1.2.1. Temperature	15
3.1.2.2. Humidity.....	15
3.1.2.3. Elevation	15
3.1.3. Electrical	15
3.1.3.1. Receptacle Ratings	16
3.1.4. Networking.....	16
3.1.4.1. Ethernet	16
3.1.4.2. Protocols.....	16

3.1.4.3.	User Interfaces	16
3.1.5.	Regulatory Compliance	16
3.1.5.1.	Underwriters Laboratories (UL)	17
3.1.5.2.	CE	17
3.1.5.3.	Federal Communications Commission (FCC)	17
3.1.5.4.	RoHS/WEEE	18
4.	Chapter 2 - Installation	19
4.1.	Pre-Installation	19
4.2.	Installation	20
4.2.1.	Mounting	20
4.2.1.1.	Full Length Brackets	21
4.2.1.2.	Mini "L" Brackets (SLB-4)	22
4.2.1.3.	Vertical Extension Brackets (VCB-1)	23
4.2.1.4.	Toolless Mounting Hardware (11621)	24
4.2.1.5.	Toolless Full Length Brackets (TLFL)	25
4.2.1.6.	Single Side Mount 2 Unit Brackets (TSMX2)	25
4.2.1.7.	Offset/Side Mount Brackets (EZB-1)	26
4.2.1.8.	7" Extension Brackets (XB-7)	27
4.2.1.9.	Flush Mount Brackets (FM)	27
4.2.1.10.	Adjustable Mount Brackets (AM)	28
4.2.1.11.	Panel Mount Brackets (PM)	28
4.2.1.12.	23" Conversion Mounting Brackets (23-RM)	29
4.2.1.13.	Cable Mount Brackets (CMB-1)	29
4.2.1.14.	19" Horizontal/Panel Mount Brackets (7938)	30
4.2.2.	Network Setup	31
5.	Chapter 3 - Setup	36
5.1.	Interchangeable Monitoring Device (IMD-3E)	36
5.2.	Vertiv Mobile App	44
5.3.	Web Interface	55

5.4.	Sensors	56
5.4.1.	Overview	56
5.4.1.1.	Configuration and Operation	58
5.4.2.	Alarms & Warnings	62
5.4.2.1.	Alarms & Warnings Configuration	63
5.4.3.	Logging	67
5.5.	System	69
5.5.1.	Users	69
5.5.2.	Network	74
5.5.3.	Web Server	80
5.5.4.	Reports	82
5.5.5.	LDAP	83
5.5.6.	Display	85
5.5.7.	Time	86
5.5.8.	SSH	86
5.5.9.	Email	87
5.5.10.	SNMP	89
5.5.11.	Syslog	90
5.5.12.	Admin	91
5.5.13.	Locale	92
5.5.14.	Utilities	92
5.6.	Help	94
5.6.1.	Info	94
5.6.2.	Support Site	95
5.7.	Technical Support	96
5.7.1.	Resetting PDU	96
5.7.2.	Service and Maintenance	96
5.7.3.	Using Microsoft Exchange as an SMTP server	96
6.	Chapter 4 - Final Checkout	98

- 6.1. Product-Specific Safety Notices..... 98
 - 6.1.1. General Safety..... 98
 - 6.1.2. Live Circuits Safety..... 98
 - 6.1.3. Equipment Grounding..... 99
 - 6.1.4. Electrostatic Discharge..... 99
 - 6.1.5. Explosive Environment..... 99
 - 6.1.6. Servicing and Adjustments..... 99
 - 6.1.7. Repairs and Modifications..... 99

1. INTRODUCTION

1.1.WELCOME

Notice to Users

Vertiv reserves the right to make changes to this document without notice to any user or reseller of this product. Vertiv also reserves the right to substitute or terminate distribution of this document, with no obligation to notify any person or party of such substitutions or terminations.

Copyrights

© 2018. Vertiv Co. All rights reserved. Vertiv and the Vertiv logo are trademarks or registered trademarks of Vertiv Co.

Trademarks

All Trademarks contained herein are registered to Vertiv Co.

Use and Disclosure Restrictions

The software and documentation contained in this publication are copyrighted materials.

Recovery Act Buy American

Vertiv products adhere to the Buy American provisions of the American Recovery and Reinvestment Act of 2009 (Recovery Act). All Vertiv goods manufactured in our Lincoln, Nebraska, plant have undergone substantial transformation during production.

Trade Agreements Act (TAA)

Vertiv goods manufactured in our Lincoln, Nebraska, plant have undergone substantial transformation during production. These Vertiv products adhere to U.S. Trade Agreements Act and can be supplied for GSA Schedules and other government contracts.

Vertiv Policy on Conflict Minerals

This document details Vertiv's corporate policy regarding the use of conflict minerals. The policy expressed in this document should be considered to cover Vertiv Co.

Section 1502 of the Dodd-Frank Act which was passed by the US Congress in 2010 requires certain companies to annually disclose their use of conflict minerals. Conflict minerals covered under this act include tantalum, tin, tungsten, and gold.

Although Vertiv is not directly subjected to the requirements of the Dodd-Frank Act, Vertiv recognizes that all companies within the electronics manufacturing industry supply chain are impacted by this legislation. Vertiv supports the intent of the law, which is the reduction of violence within the Democratic Republic of the Congo and will take several actions to both advance the goals of the Dodd-Frank Act and to provide exceptional support to our customers.

- Vertiv will work with our direct suppliers to identify purchased components and materials that contain tin, tantalum, tungsten or gold.
- Vertiv will work with our direct suppliers to trace sources of any tin, tantalum, tungsten or gold used in our products back to the smelter.
- Vertiv will document our efforts to trace tin, tantalum, tungsten, and gold minerals back to the smelter and will accurately report the results to our customers.
- Vertiv will continue to monitor industry progress in identifying conflict-free smelters and will adjust corporate policy as the electronics supply chain becomes more fully documented.

Vertiv will not require that our direct suppliers source only conflict-free minerals until an adequate number of smelters has been reliably identified and audited by The Electronic Industry Citizenship Coalition (EICC) and the Global e-Sustainability Initiative (GeSI) to service the electronic industry supply chain. Mandating a conflict-free supply chain before an adequate number of smelters has been identified will prohibit the use of all tin, tantalum, tungsten, and gold originating in the Democratic Republic of the Congo and surrounding countries. This prohibition would cut off the sole income source for many artisanal miners within the region and may result in increased violence within the Democratic Republic of the Congo in direct opposition to the goals of the Dodd-Frank Act. Vertiv will work continuously with our direct suppliers in order to annually increase the percentage of documented conflict-free minerals that are used in our products until all products can be certified as conflict-free.

WEEE Declaration

Vertiv is obligated to finance the cost of the collection, treatment, recovery and environmentally sound disposal of all products sold by Vertiv into the UK market this includes:

- New WEEE (displaying 'the crossed out wheeled bin symbol') that Vertiv has placed onto the market after the 13th August 2005; and
- Historic WEEE (not displaying 'the crossed out wheeled bin symbol'), when Vertiv is supplying new WEEE that is intended to replace the historic WEEE and is of equivalent type or fulfills the same function even if the historic WEEE was manufactured by a third party.

Document Usage

All reasonable efforts have been made to assure the accuracy of this document from any technical or typographical errors or omissions. Vertiv and its affiliates disclaim responsibility for any labor, materials, or costs incurred as a result of usage of this document. Nor shall Vertiv and its affiliates be liable for any damages, inclusive of loss of profits or data, arising from the use of or in connection with this document.

Vertiv reserves the right to make changes to this document without notice to any user or reseller of this product. Vertiv also reserves the right to substitute or terminate distribution of this document, with no obligation to notify any person or party of such substitutions or terminations.

2. ABOUT THIS MANUAL

This document provides an overview of Vertiv product(s), the major topics covered include:

- Copyright, Trademarks, and Disclosure Restrictions.
- Instructions for installing, powering and using the equipment.
- Information that will aid in managing and maintaining the equipment.

2.1. ORGANIZATION OF THE MANUAL

This Vertiv document contains the following product information:

- Product Specifications - This chapter describes the major product characteristics and its functional role within the system. Where appropriate, reference to cabling among product components and to other Vertiv product(s) is provided.
- Installation - This chapter provides installation information for the preparation and use of Vertiv products as well as procedures required to adequately mechanically and electrically attach Vertiv product into supporting systems.
- Setup - This chapter provides instructions on power-up procedures after product installation and configuration of the software and features.
- Final Checkout - Technical Support guidelines and safety information are provided in this chapter.

2.2. AUDIENCE PROFILE

This document is intended for use by authorized technicians experienced with some of similar product types and for personnel requiring guidance for equipment installation, operation, maintenance, and support.

2.3. ON-LINE DOCUMENTATION

Product firmware updates can be found and downloaded from the [Vertiv Support](#) site, under [Firmware Updates](#).

2.4. REPORTING DOCUMENT ERRORS

Should you discover any error or identify a deficiency in this document, please take time to contact us at the following email address:

Vertiv-Documents@vertivco.com

Please be sure to provide us with the document name, part number, and page number(s). Also, please provide us with description of the error or the deficiency for the document. If you would like for us to contact you, please provide us with your name and contact information.

Thank you for your time. We appreciate any comments and feedback you can provide.

2.5. CONVENTIONS

The information contained within this document is established around the framework of various conventions, which are defined as follows:

2.5.1. SOFTWARE











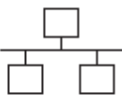

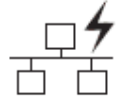

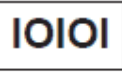

- Release Management: Product name, Version control
 - Product Name: Name of Hardware Platform
 - Version control: V(ersion) Platform #, Major #, Minor #
 - Example: GU v3.0.0

2.5.2. HARDWARE

Product Classification

- Power Distribution Unit
 - Basic
 - Metered only
 - Monitored only
 - Switched only
 - Monitored + Switched
- Environmental Monitoring
 - Standard
 - Wireless
- Cooling
 - Passive
 - Active
- Data Center Infrastructure Management (DCIM)

Figure 1 Overlay Symbology Guide

	Ethernet		Activity / Idle
	Power over Ethernet		Power
	Serial		Amps
	Remote Display		Reboot
	Remote Sensors		Silence
	Uplink		Scroll
	Temp		GU Right
	Sensor Configuration		GU Left
		GU Center	

2.5.3. SAFETY

This document contains varying levels of alerts pertaining to product and user safety. The alerts are visually presented with graphics and text per Vertiv equipment guidelines.

The representations are:



DANGER

INDICATES AN **IMMINENT** HAZARDOUS SITUATION WHICH, IF NOT AVOIDED, WILL RESULT IN **DEATH OR SERIOUS INJURY**.



WARNING

INDICATES A **POTENTIAL** HAZARDOUS SITUATION WHICH, IF NOT AVOIDED, COULD RESULT IN **DEATH OR SERIOUS INJURY**.



CAUTION

INDICATES A **POTENTIAL** HAZARDOUS SITUATION WHICH, IF NOT AVOIDED, COULD RESULT IN **PRODUCT DAMAGE AND MINOR TO MODERATE INJURY**.



NOTE

Provides useful information that is beneficial for operation and usage of this product.

2.5.4. FIGURES

Figures presented in this document are identified and designated as follows:

'Figure:', Chapter # - Image #

Example:

Figure 1-1 Name and/or Title goes here



2.5.5. TABLES

Tables presented in this document are identified and designated as follows:

'Table:', Chapter # - Image #

Example:

Table 1-1 Name and/or Title goes here

Column 1	Column 2	Column 3	Column 4	Column 5
Text	Text	Text	Text	Text
Text	Text	Text	Text	Text
Text	Text	Text	Text	Text
Text	Text	Text	Text	Text

3. CHAPTER 1 - PRODUCT SPECIFICATIONS

3.1. PRODUCT SPECIFICATIONS

3.1.1. OVERVIEW

The Vertiv Upgradeable second generation (GU2) product is a high tier rack level power distribution unit (PDU) with input and output monitoring, outlet level switching, remote network access via an embedded Vertiv API, and with external sensor support via built-in Enhanced Communications (EC) card. The embedded web based Graphical User Interface (GUI) provides access to user product configuration and data logging.

GU2 PDUs are available in a wide range of SKUs to support all standard global input voltages, enterprise and hyperscale rack loads of over 20 kVA, and single-phase and three-phase Delta or Wye building wiring configurations.

Table 1-1 GU2 Families

	Input Power Monitoring	Outlet Level Power Monitoring	Outlet Level Switching
Switched Input Level Monitoring EC	•		•
Outlet Level Monitoring EC	•	•	
Switched Outlet Level Monitoring EC	•	•	•

3.1.2. ENVIRONMENTAL

The operational environmental limits pertaining to Temperature, Humidity and Elevation are as defined below.

3.1.2.1. TEMPERATURE

Table 1-2 Temperature Limits

	Minimum	Maximum
Operating	10°C (50°F)	60°C (140°F) UL Listed Models 50°C (122°F) CE Marked Models
Storage	-25°C (-13°F)	65°C (149°F)

3.1.2.2. HUMIDITY

Table 1-3 Humidity Limits

	Minimum	Maximum
Operating	5%	95% (non-condensing)
Storage	5%	95% (non-condensing)

3.1.2.3. ELEVATION

Table 1-4 Elevation Limits

	Minimum	Maximum
Operating	0 m (0 ft)	3,200 m (10,500 ft)
Storage	0 m (0 ft)	15,240 m (50,000 ft)

3.1.3. ELECTRICAL

Electrical product characteristics and performance are defined below. Also, please see the product nameplate for additional rating limits.

3.1.3.1. RECEPTACLE RATINGS

Table 1-5 Receptacle Ratings

Type	Ratings
NEMA 5-20R	125Vac, 16A
U-Lock Locking IEC-60320 C13	250Vac, 10A (UL & CSA 12A, 250Vac)
U-Lock Locking IEC-60320 C19	250Vac, 16A (UL & CSA 16A, 250Vac)

3.1.4. NETWORKING

The product communications requirements are identified below.

3.1.4.1. ETHERNET

The Ethernet link speed for this product is: 10/100 Mb; full duplex.

3.1.4.2. PROTOCOLS

The communications protocols supported by this product include:
 ARP, IPv4, IPv6, ICMP, ICMPv6, NDP, TCP, UDP, RSTP, STP, DNS, HTTP, HTTPS (TLSv1.2),
 SMTP, SMTPS, DHCP, SNMP (v1/v2c/v3), LDAP, NTP, SSH, and Syslog.

3.1.4.3. USER INTERFACES

This product supports the following user interfaces:

SNMP, JSON-based Web GUI, JSON API, and Command-line interface using SSH.

3.1.5. REGULATORY COMPLIANCE

Vertiv products are regulated for Safety, Emissions, and Environment Impact per the below agencies and policies.

3.1.5.1. UNDERWRITERS LABORATORIES (UL)

UL Standards are used to assess products; test components, materials, systems and performance; and evaluate environmentally sustainable products, renewable energies, food and water products, recycling systems and other innovative technologies.

The UL standards specific to this equipment are listed in the UL Online Certification Library under the file number noted on the device name plate.

3.1.5.2. CE

The placement of the CE mark on a product signifies a manufacturer's declaration that the product complies with the applicable European (EU) health, safety, and environmental protection requirements, including EU legislation and product directives. The CE mark is required for products offered for sale within the European Economic Area (EEA).

The specific regulations, directives, and standards applicable to each product are specified on the Declaration of Conformity.

3.1.5.3. FEDERAL COMMUNICATIONS COMMISSION (FCC)

The Federal Communications Commission (FCC) regulates interstate and international communications by radio, television, wire, satellite, and cable in all 50 states, the District of Columbia and U.S. territories. An independent U.S. government agency overseen by Congress, the commission is the United States' primary authority for communications laws, regulation and technological innovation.

The FCC standards specific to this equipment are:

This Class A device complies with part 15 of the FCC Rules. Operation is subject to the following two conditions:

- (1) This device may not cause harmful interference
- (2) This device must accept any interference received, including interference that may cause undesired operation.

This Class A digital apparatus complies with Canadian ICES-003.

Cet appareil numérique de la classe A est conforme à la norme NMB-003 du Canada.



WARNING

Changes or modifications to this unit not expressly approved by the party responsible for compliance could void the user's authority to operate this equipment.

3.1.5.4. ROHS/WEEE

WEEE stands for Waste from Electrical and Electronic Equipment. WEEE Directive 2002/96/EC mandates the treatment, recovery and recycling of electric and electronic equipment (90% ends up in landfills). All applicable products in the EU market must pass WEEE compliance and carry the "Wheelie Bin" sticker.

RoHS, also known as Lead-Free, stands for Restriction of Hazardous Substances. RoHS, also known as Directive 2002/95/EC, originated in the European Union and restricts the use of six hazardous materials found in electrical and electronic products. All applicable products in the EU market after July 1, 2006 must pass RoHS compliance. RoHS impacts the entire electronics industry and many electrical products as well.

RoHS specifies maximum levels for the following six restricted materials:

- Lead (Pb): < 1000 ppm
- Mercury (Hg): < 100 ppm
- Cadmium (Cd): < 100 ppm
- Hexavalent Chromium: (Cr VI) < 1000 ppm
- Polybrominated Biphenyls (PBB): < 1000 ppm
- Polybrominated Diphenyl Ethers (PBDE): < 1000 ppm
- Bis(2-Ethylhexyl) phthalate (DEHP): < 1000 ppm
- Benzyl butyl phthalate (BBP): < 1000 ppm
- Dibutyl phthalate (DBP): < 1000 ppm
- Diisobutyl phthalate (DIBP): < 1000 ppm

See product label for RoHS/WEEE compliance marks.

4. CHAPTER 2 - INSTALLATION

4.1. PRE-INSTALLATION

- The ambient temperature of the installation location should be not greater than 60°C.



NOTE

Maximum environmental operating temperature is 60°C at full input and output nameplate rating, and with per receptacles max loading of 50% of outlet rating.

- Install the PDU such that the amount of airflow required for safe operation of equipment is not compromised.
- Mount the PDU so that a hazardous condition is not achieved due to uneven mechanical loading.
- Follow nameplate ratings when connecting equipment to the branch circuit. Take into consideration the effect that overloading of the circuits might have on overcurrent protection and supplied wiring.
- The PDU relies on the building installation for protection from overcurrent. A certified overcurrent protection device is required in the building installation. The overcurrent protection device should be sized according to the PDU's nameplate ratings and local/national electrical code.
- Reliable earthing of rack-mount equipment should be maintained. Particular attention should be given to supply connections other than direct connections to the branch circuit. The PDU must be connected to an earthed socket outlet.
- PDU is intended for restricted-access locations. Only qualified service personnel should install and access the PDU.
- For pluggable equipment, install the PDU so the input plug or appliance coupler may be disconnected for service.
- The PDU is intended for indoor use only. Do not install the unit in wet or outdoor environments, and do not install it next to water tanks or plumbing.
- The PDU is intended for use with TN, TT, or IT power supply systems.

4.2. INSTALLATION

4.2.1. MOUNTING

Optional brackets sold separately.

1. Using appropriate hardware, mount unit to rack. (See below examples.)
2. Plug PDU into an appropriately-rated and protected branch-circuit receptacle.
3. Plug in the devices to be powered by the PDU.
4. Turn on each device connected to the PDU. Sequential power-up is recommended to avoid high inrush current.

4.2.1.1. FULL LENGTH BRACKETS

Figure 2-1 Full Length Bracket

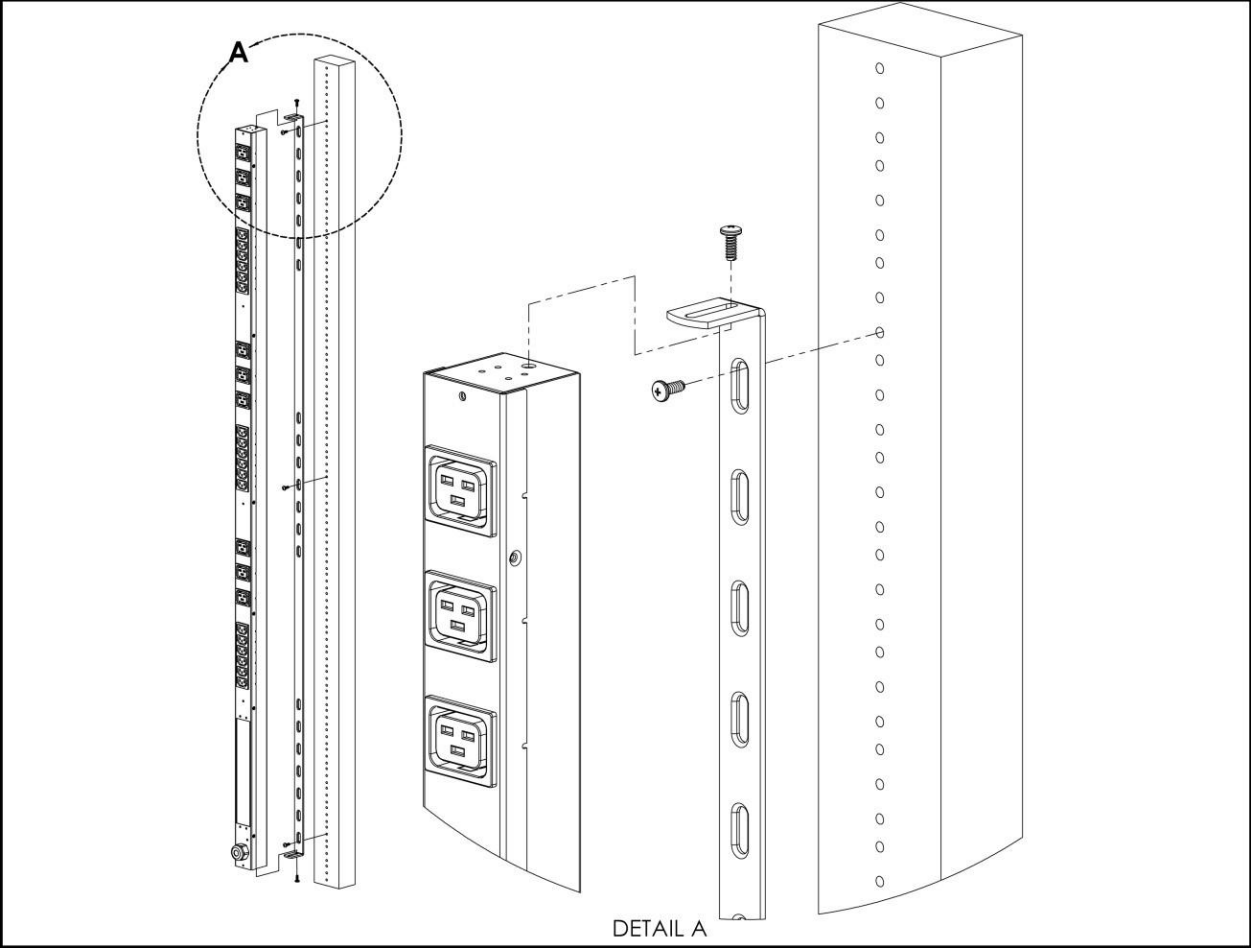

4.2.1.2. MINI "L" BRACKETS (SLB-4)

Figure 2-2 Mini L Brackets

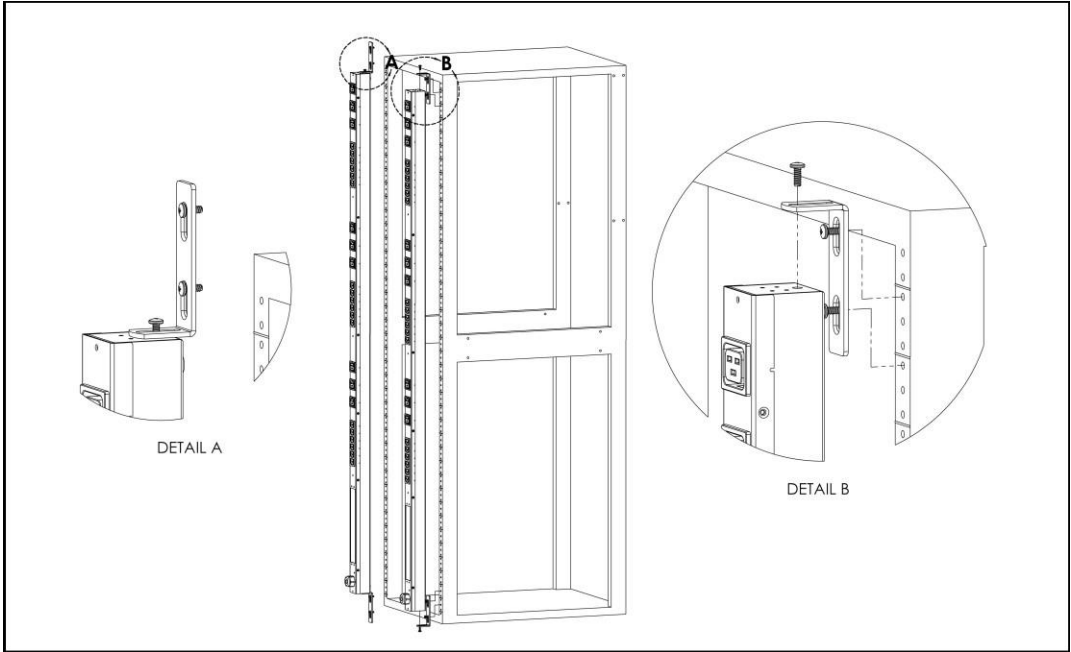

4.2.1.3. VERTICAL EXTENSION BRACKETS (VCB-1)

Figure 2-3 Vertical Extension Brackets

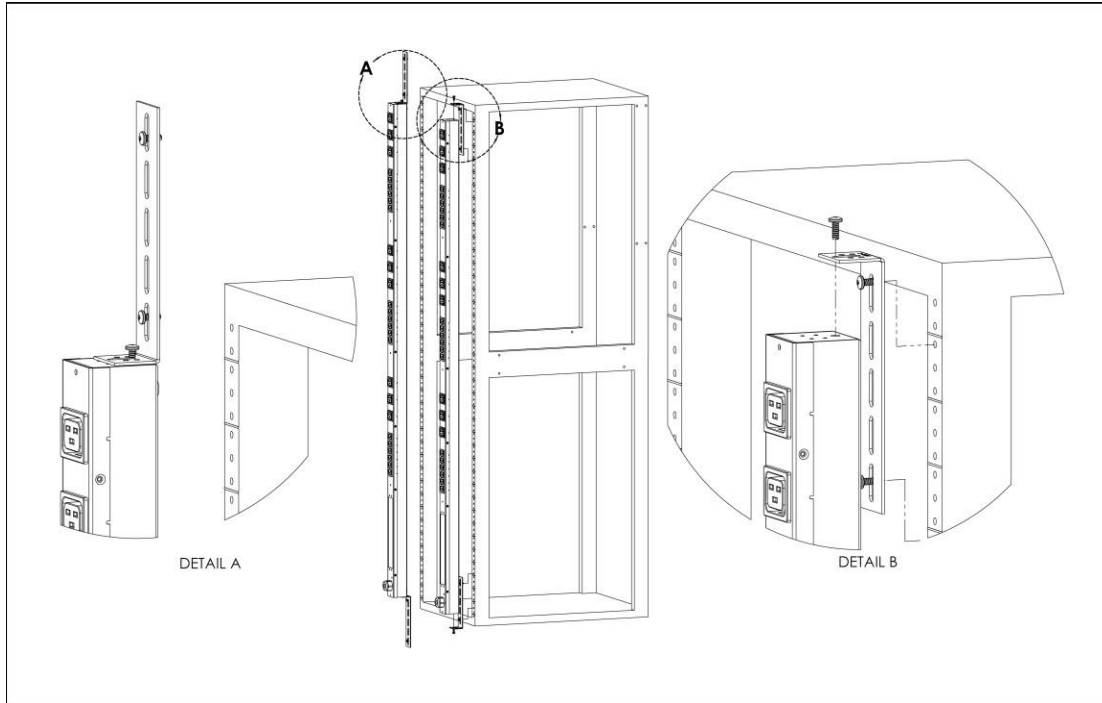

4.2.1.4. TOOLLESS MOUNTING HARDWARE (11621)

Figure 2-4 Toolless Mounting Hardware

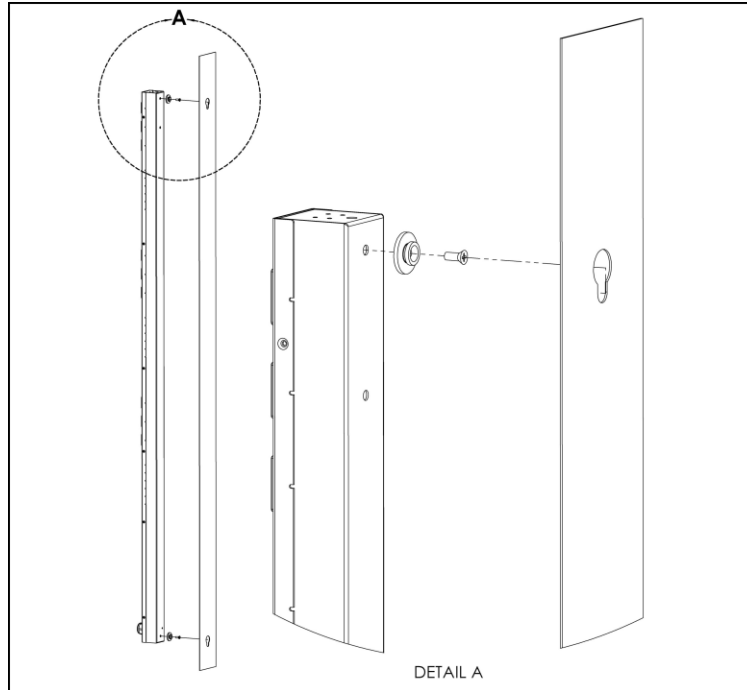

4.2.1.5. TOOLLESS FULL LENGTH BRACKETS (TLFL)

Figure 2-5 Toolless Full Length Brackets

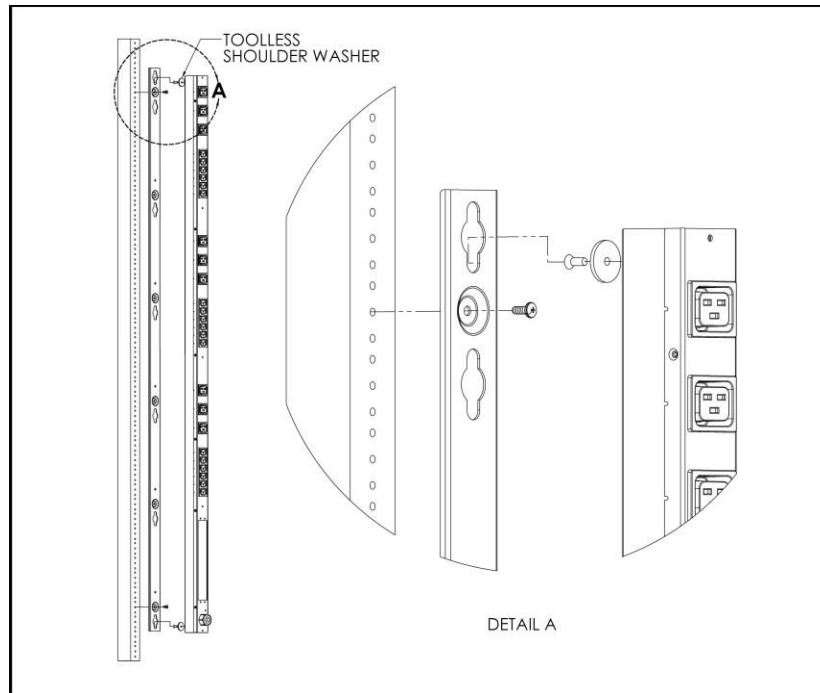

4.2.1.6. SINGLE SIDE MOUNT 2 UNIT BRACKETS (TSMX2)

Figure 2-6 Single Side Mount 2 Units Brackets

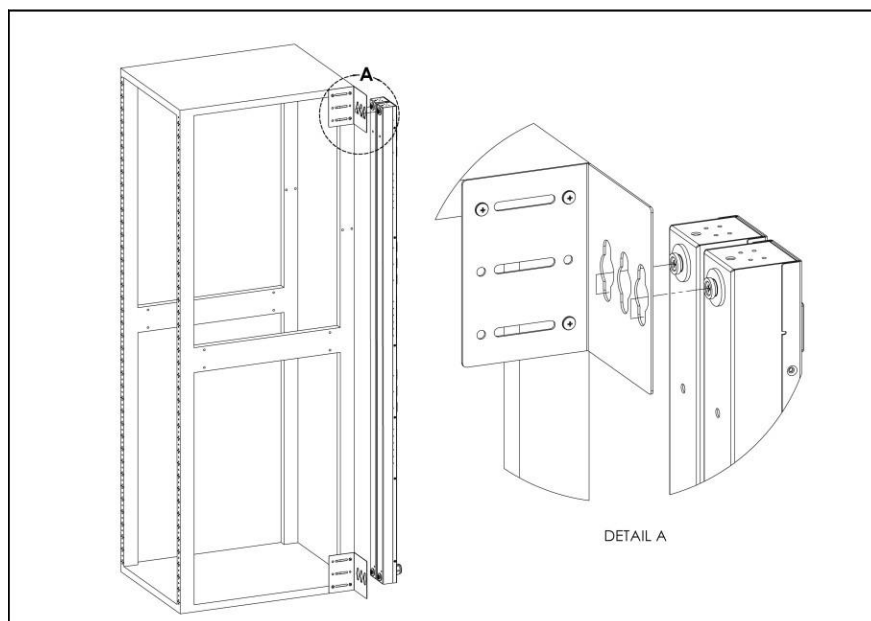

4.2.1.7. OFFSET/SIDE MOUNT BRACKETS (EZB-1)

Figure 2-7 Offset/Side Mount Brackets

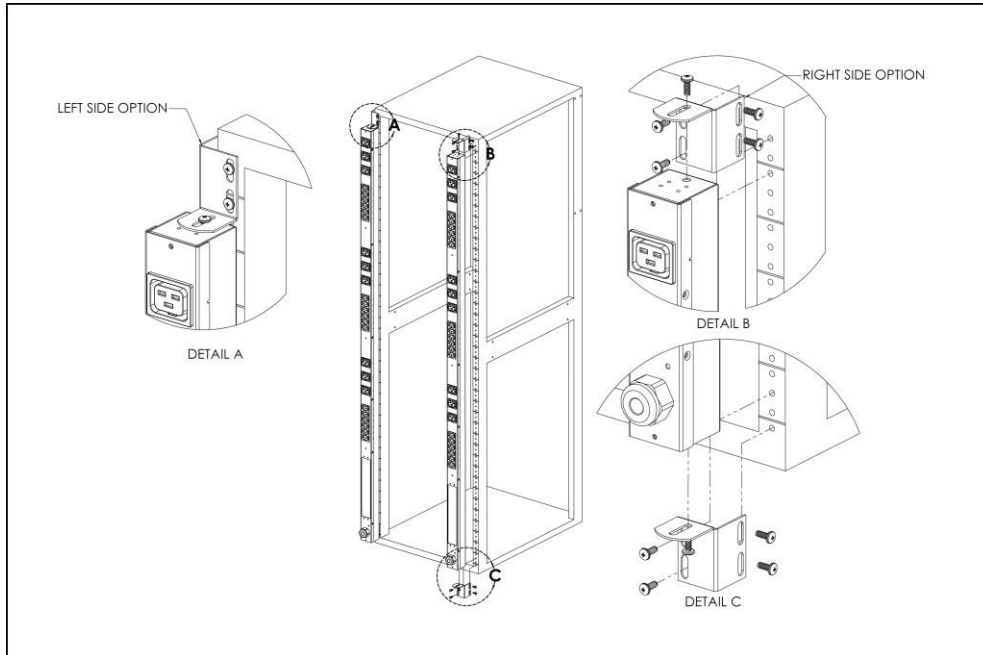

4.2.1.8. 7" EXTENSION BRACKETS (XB-7)

Figure 2-8 7" Extension Brackets

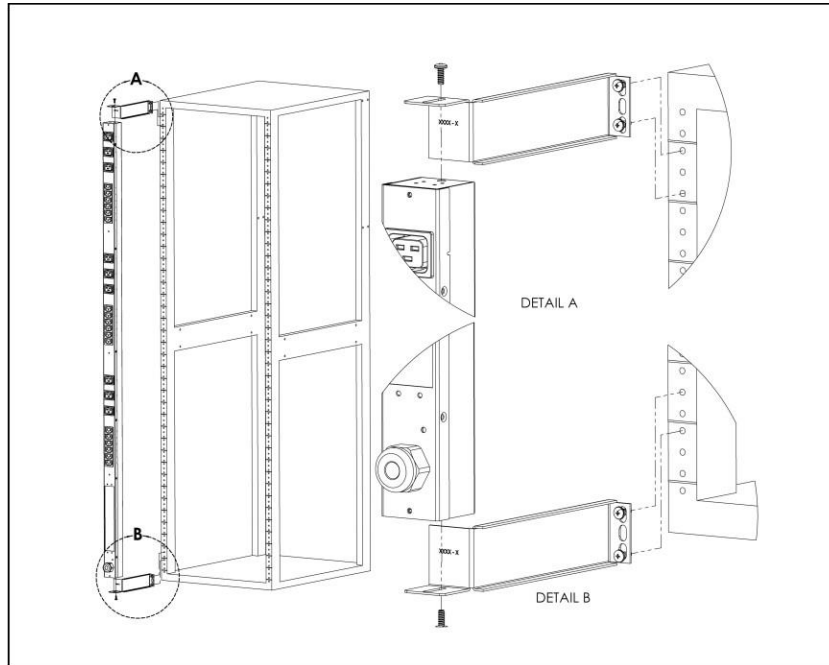

4.2.1.9. FLUSH MOUNT BRACKETS (FM)

Figure 2-9 Flush Mount Brackets

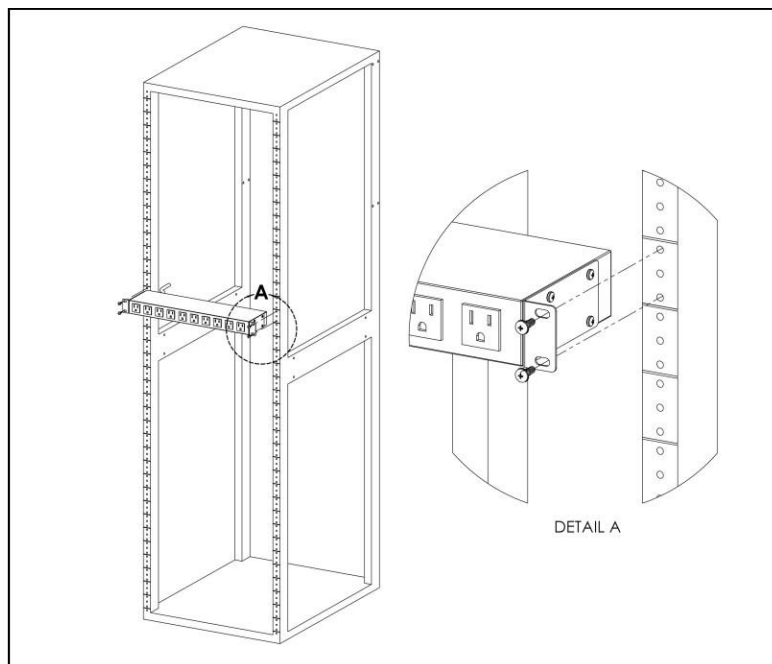

4.2.1.10. ADJUSTABLE MOUNT BRACKETS (AM)

Figure 2-10 Adjustable Mount Brackets

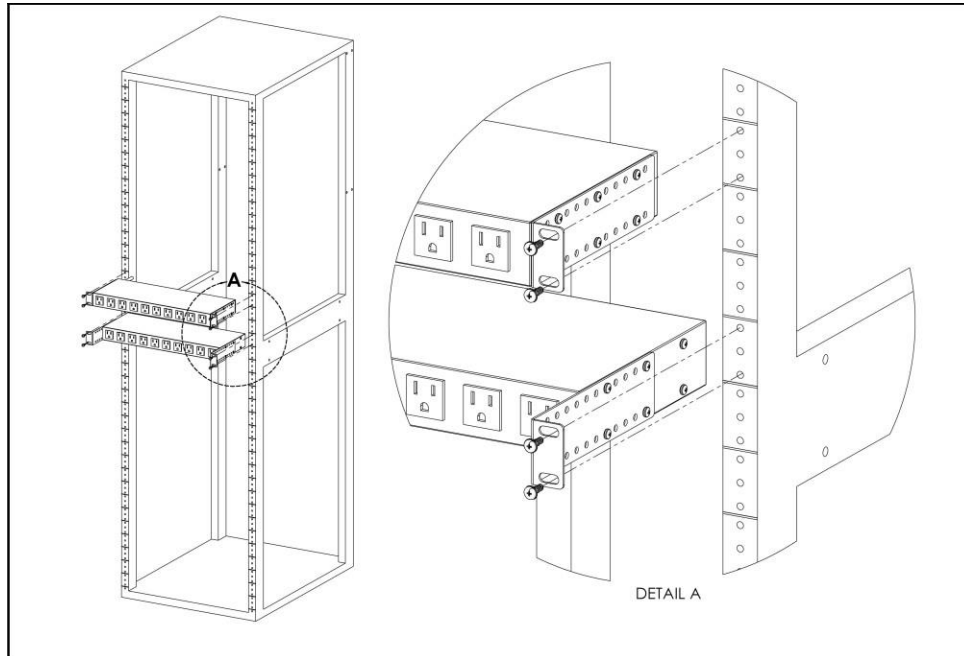

4.2.1.11. PANEL MOUNT BRACKETS (PM)

Figure 2-11 Panel Mount Brackets

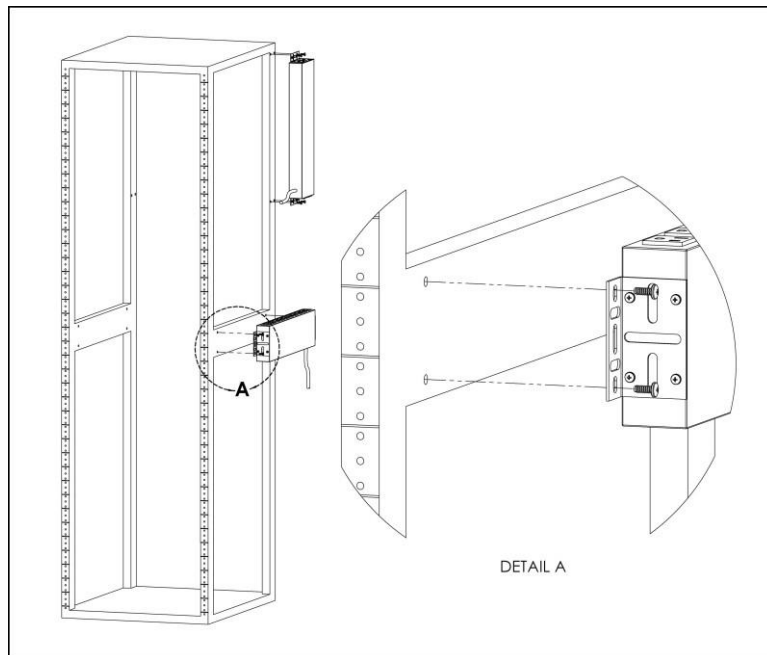

4.2.1.12. 23" CONVERSION MOUNTING BRACKETS (23-RM)

Figure 2-12 23" Conversion Mounting Brackets

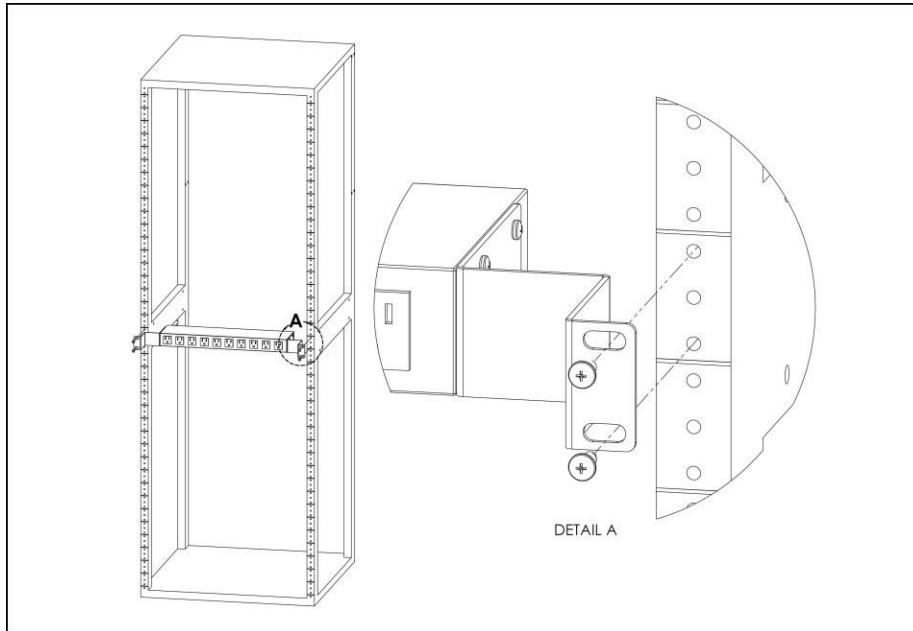

4.2.1.13. 19" HORIZONTAL/PANEL MOUNT BRACKETS (7938)

Figure 2-14 19" Horizontal/Panel Mount Brackets

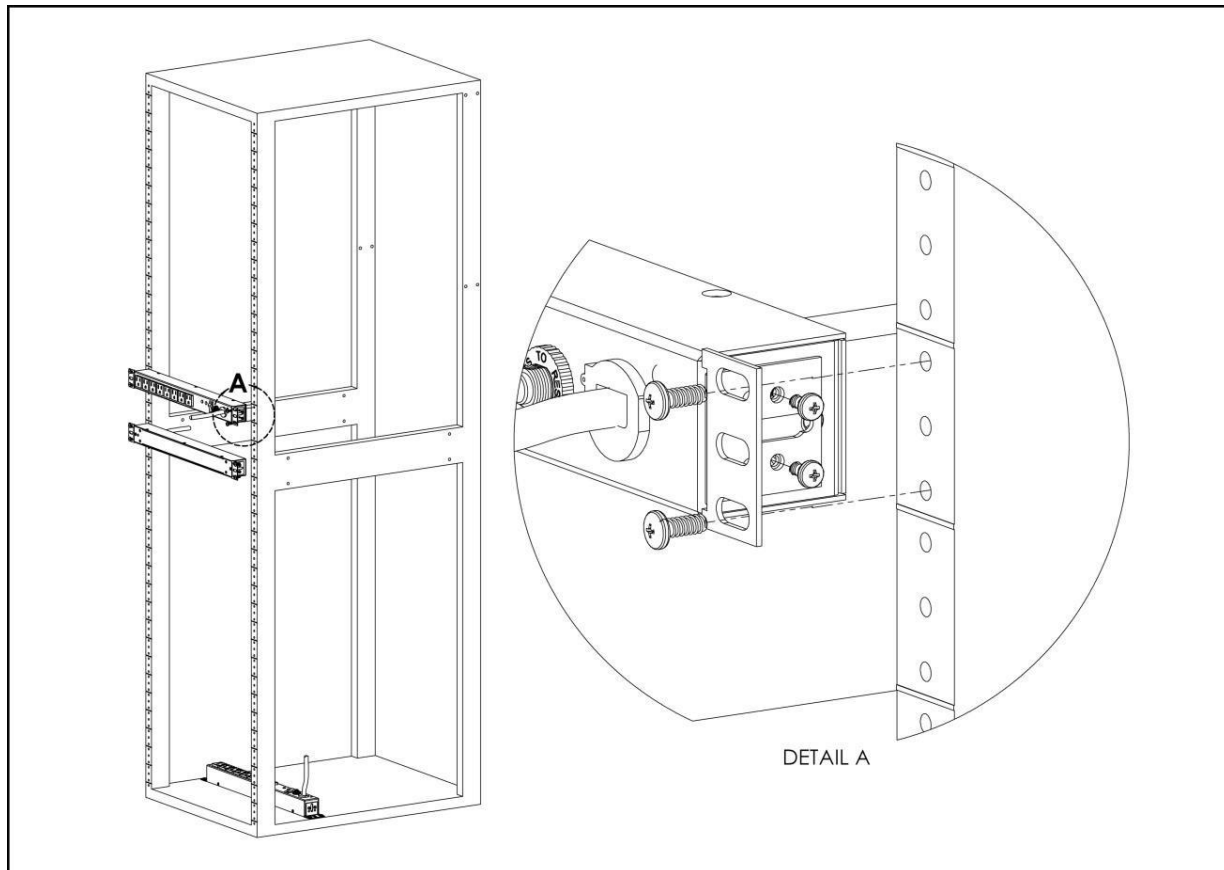

4.2.2. NETWORK SETUP

The Vertiv Upgradeable IMD has a default IP address for initial setup and access. To remove configured IP addresses and restore the unit to its default IP address and reset all user-account information, if the user-assigned address or passwords are lost or forgotten, press and hold the network-reset button located below the Ethernet port number 2 for 5 seconds. Holding the center button of the LED display for 10 seconds will also reset the network and user account information.

The Network page (located under the System Tab) allows you to assign the network properties manually, or use DHCP to connect to your network. Access to the unit requires the IP address to be known. Use of a static IP or a reserved DHCP is recommended. The default address is shown on the front of the unit:

Table 2-1 Default IP Address

IP Address:	192.168.123.123
Subnet Mask:	255.255.255.0
Gateway:	192.168.123.1

To access the unit for the first time, you will need to temporarily change your computer's network settings to match the 192.168.123. xxx subnet. To set up the unit, connect it to your computer's Ethernet port, then follow the appropriate instructions for your computer's operating system.

Windows

· **Windows 2000 / XP / Server 2003:**

Click the **Start** button, choose **Settings**, then **Network Connections**.

· **Windows 7 / Server 2008:**

Click the **Start** button, then choose **Control Panel >> Adjust Your Computer's Settings >> View Network Status and Tasks >> Change Adapter Settings**.

(Alternatively, on some Windows 7 machines, this may be **Start**, then **Settings >> Control Panel >> Network and Sharing Center >> Change Adapter Settings**.)

· **Windows 8 / Server 2012:**

Move the mouse cursor to the bottom or top right corner of the screen, click the **Settings** icon, then select **Control Panel**. Change the view type from **Category** to **Large** or **Small Icons** if necessary, then select **Network and Sharing Center**, then **Change Adapter Settings**.

Windows 10:

Click the **Start** button, then choose **Network & Internet**, then click **Change adapter options**.

Locate the entry under **LAN or High-Speed Internet** or **Local Area Connection** which corresponds to the network card (NIC).



NOTE

Most computers will have a single Ethernet NIC installed, but a WiFi or 3G adapter will also show as a NIC in this list, so be sure to choose the correct entry.

Double-click on the network adapter's entry in the **Network Connections** list to open its status dialog box, then click the **Properties** button to open the **Local Properties** window.

Figure 2-15 Local Area Connection Properties

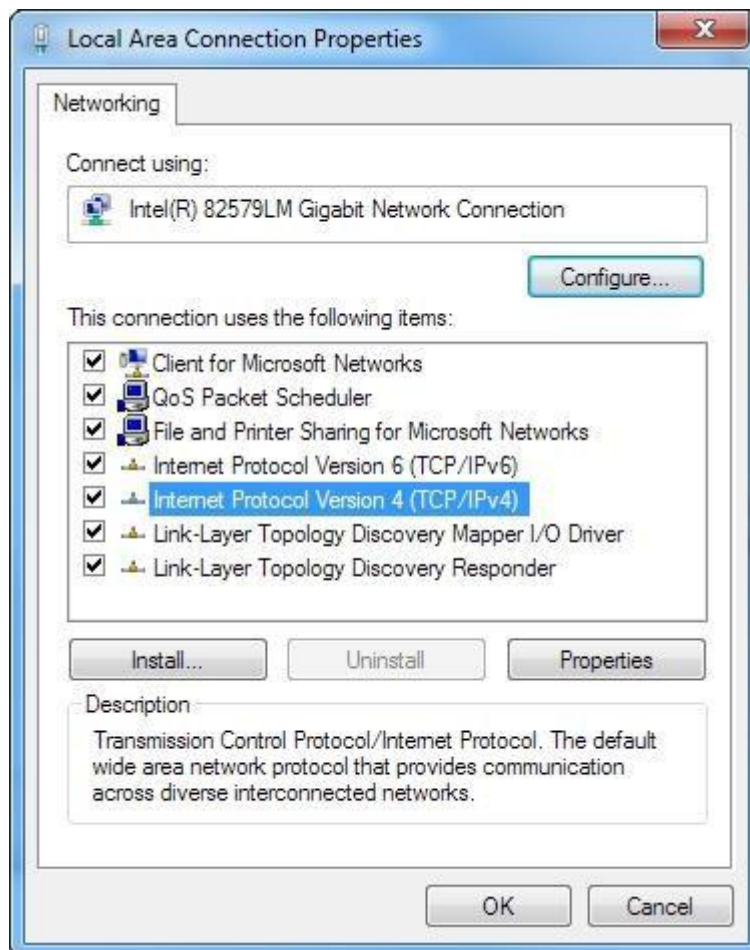

Find the entry titled "**Internet Protocol Version 4 (TCP/IPv4)**" in the list, then click the **Properties** button to open the **Internet Protocol Properties** window. If you see more than one TCP/IP entry, as in the example above, the computer may be configured for IPv6 support as well as IPv4; make sure to select the entry for the IPv4 protocol. Write down the current NIC card settings so you can restore them to normal after you have completed the setup procedure.

Figure 2-16 Internet Protocol Version 4

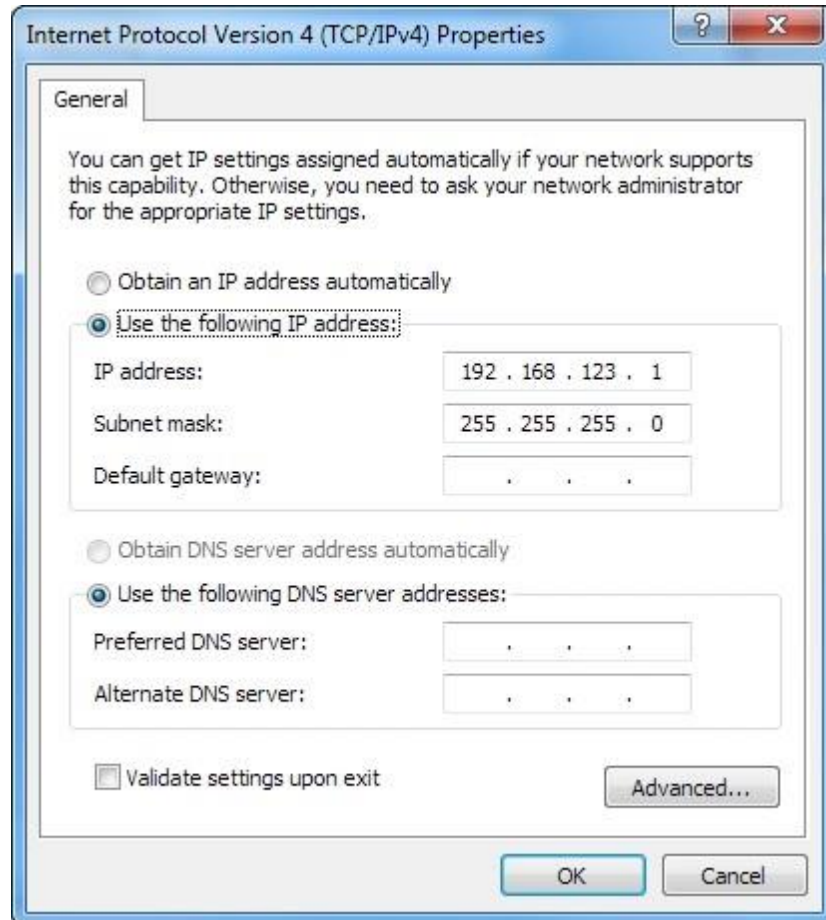

Choose the **Use the following IP address** option, then set **IP address** to 192.168.123.1 and **Subnet Mask** to 255.255.255.0. For this initial setup, **Default Gateway** and the **DNS Server** entries can be left blank. Select **OK**, then **OK** again to close both the **Internet Protocol Properties** and **Local Properties** windows.

Once the NIC settings are configured properly, you should be able to access the unit by typing <http://192.168.123.123> into the address bar of your web browser. If you are setting up the unit for the first time, or if the unit has been reset back to factory defaults via the network-reset button, the unit will require you to create an Admin account and password before you can proceed.

Once you have created an Admin account and have logged into it, the unit's default **Sensors** page should come up by default. Navigate to the **System** tab, then the **Network** page to configure the device's network properties. The unit's IP Address, Subnet Mask, Gateway, and DNS settings can either be assigned manually, or acquired via DHCP.

Note that the new settings will take effect when the **Save** button is clicked. The browser will no longer be able to reload the web page from the 192.168.123.123 address and will probably display a "page not found" or "host unavailable" message. This behavior is normal. Once you have finished configuring the unit's IP address, simply repeat the steps above, and change the computer's Ethernet NIC card settings back to the ones you wrote down prior to changing them, to restore its normal network and internet settings.

Mac

Click the **System Preferences** icon on the Dock, and choose **Network**.

Figure 2-17 Mac System Preferences

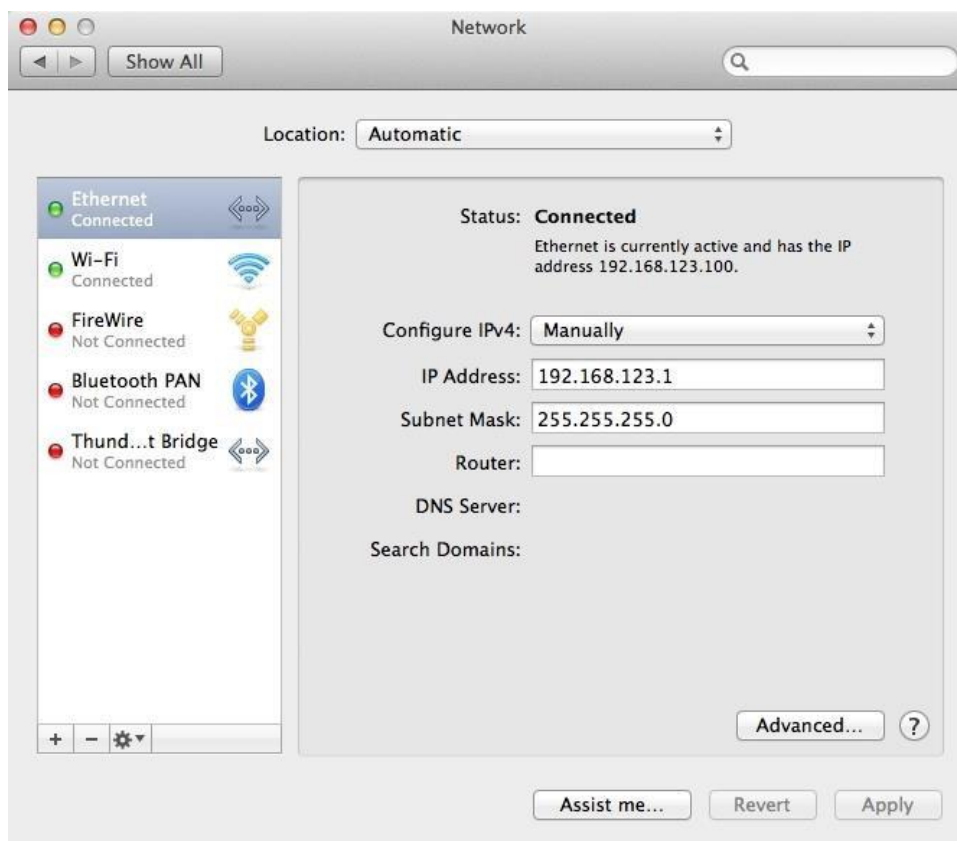

Be sure **Ethernet** is highlighted on the left side of the NIC window. In most cases, there will be one Ethernet entry on a Mac. Write down the current settings so you can restore them to normal after you have completed the setup procedure.

Select **Manually** from the **Configure IPv4** drop-down list, then set **IP Address** to 192.168.123.1 and **Subnet Mask** to 255.255.255.0. (The **Router** and **DNS Server** settings can be left blank for this initial setup.) Click **Apply** when finished.

Once the NIC settings are configured properly, you should be able to access the unit by typing `http://192.168.123.123` into the address bar of your web browser. If you are setting up the unit for the first time, or if the unit has been reset back to factory defaults via the network-reset button, the unit will require you to create an Admin account and password before you can proceed.

Once you have created the Admin account and logged into it, the unit's default **Sensors** page should come up by default. Navigate to the **System** tab, then the **Network** page to configure the device's network properties. The unit's IP Address, Subnet Mask, Gateway, and DNS settings can either be assigned manually, or acquired via DHCP.

The new settings will take effect when the **Save** button is clicked, so the browser will no longer be able to reload the web page from the 192.168.123.123 address and will probably display a "page not found" or "host unavailable" message. This behavior is normal. Once you have finished configuring the unit's IP address, simply repeat the steps above, and change the computer's Ethernet NIC card settings back to the ones you wrote down prior to changing them, to restore its normal network and internet settings.

5. CHAPTER 3 - SETUP

5.1. INTERCHANGEABLE MONITORING DEVICE (IMD-3E)

The Interchangeable Monitoring Device (IMD) is the controller for the GU2 line of power products. The IMD can be replaced and upgraded to allow data-centers to future-proof their locations.

Figure 3-1 IMD-3E Module

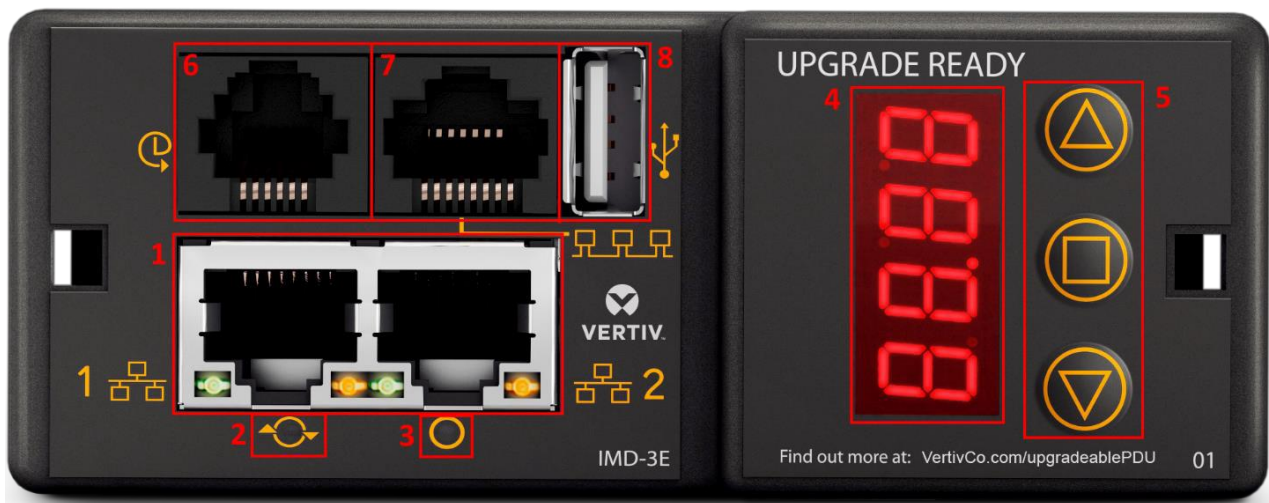

1. **Dual Ethernet Ports:** The Dual Ethernet ports act as a 2-port Ethernet switch, allowing for multiple devices to be daisy-chained.
2. **Hard-Reboot Button:** Pressing the hard-reboot button reboots the IMD. This acts as a power-cycle for the IMD, and does not change or remove any user information. Initiating a hard-reboot **will not** affect power to any equipment connected to the PDU output receptacles.
3. **Network-Reset Button:** Holding the network-reset button for 5 seconds during normal operation will restore the network, HTTP, user account and LDAP settings to their factory defaults.
4. **Local Display:** The local display will display the phase, line, and circuit current values (in Amperes).

5. **Display Buttons:** There are three buttons near the IMD display; a back button, a forward button, and a center button. The functions of these buttons are as follows:

Back Button  Decrement to the previous channel.

Holding this button for 3 seconds initiates a [configuration backup](#). The display will show a "bcup" message while the backup is being generated and will then go back to normal operation.

Forward Button  Increment to the next channel.

Holding this button for 3 seconds initiates a [configuration restore](#). The display will show a "rest" message followed by a "conf" message and then a 3 second countdown. Once the countdown expires, a "8888" message is displayed and the backup will be applied. If the button is released at any time during this sequence, the restore is aborted. The display will then go back to normal operation.

Center Button  Toggle between scrolling and static display modes.

Holding this button for 3 seconds initiates a parameter reset sequence. This sequence consists of a "rset" message, followed by a "dflt" message and then a 3 second countdown. Once the countdown expires, a "8888" message is displayed and the network, http, user accounts, and LDAP information is reset to default values. If the button is released at any time during this sequence, the reset is aborted.



Flip the display 180 degrees. Both buttons must be pressed at the same time.



Display the unit's primary IPv4 address. Both buttons must be pressed at the same time.



x 3

Enable VLC* mode by pressing the center button three times within 2 seconds. Pressing the button while VLC mode is active will return the unit to the standard Current display.

*See VLC section of manual for more information on this feature.

	<p>NOTE</p> <p>Display Button functionality may vary based on unit configuration.</p>
--	--

6. **Remote Sensor Port** : RJ12 port for connecting a Vertiv plug-and-play remote digital sensors (sold separately). Each digital sensor has a unique serial number and is automatically discovered. GU2 PDUs support up to 16 sensors. The optional Vertiv A2D Converter can be added to support analog sensing.

7. **Proprietary Connectivity** : RJ45 port for future expansion.

8. **USB Port** : USB Port used to upload firmware, backup/restore device configuration, or expanded logging capacity via USB storage device. Provides up to 500mA power capacity for USB connected devices.

	<p>NOTE</p> <p>GU2 PDUs support the use of USB MSC devices such as thumb drives or external hard drives. USB Storage Devices must be formatted as FAT32.</p>
--	---

Rapid Spanning Tree Protocol (RSTP)

GU2 devices include two Ethernet ports which work together as an internal Ethernet bridge. One of these ports can be used to connect the IMD to an existing network, or both ports can be used at the same time to connect one IMD to another in a daisy-chain configuration.

When both network interfaces are connected, the IMD implements a network bridging protocol called Rapid Spanning Tree Protocol (RSTP). RSTP is an IEEE standard that is implemented by all managed bridges. Using RSTP, bridges in the network exchange information to find redundant paths, or loops.

When a loop is detected, the bridges in the network work together to temporarily disable the redundant paths. This allows the network to avoid broadcast storms caused by the loops. In addition, RSTP regularly checks for changes in the network topology. When a connection is lost, RSTP allows the bridges to quickly switch to a redundant path.

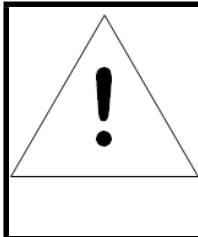
	<p>NOTE</p> <p>RSTP protocol imposes a limit of 40 links between bridges, including IMDs.</p>
---	--

Visible Light Communication (VLC)

The VLC feature on Vertiv Upgradeable PDUs allows the user to unobtrusively upload product information into a database management system via the embedded LED display. This product feature provides new opportunities to monitor and enable larger amounts of PDU power data to be obtained via the unit's display, and all without physically connecting to the PDU.

Using a smart device, such as a smart phone or tablet with the Vertiv Mobile app installed, it is possible to capture data from the LED display when running in VLC mode, which can be enabled/disabled easily by using the display buttons on the device, or using the GUI on monitored units.

By default, the Vertiv Upgradeable LED display will provide the Current (Amps) per input and circuit/breaker. By enabling the VLC feature, the LED Display will scroll through a set of alpha-numeric characters. Utilizing the Vertiv Mobile app the user can scan the LED display and retrieve additional power metrics which include Volts, Amps, Watts, Volt-Amps and Kilowatt Hours.

Before VLC, the power data was only available on network connected PDUs by viewing the GUI, or using external software to collect and display the data. The VLC feature provides this data on local metered only devices, as well as on monitored units without the need to connect them to the network.

**NOTE**

To Enable VLC – Press the center square  **button** three times in under 2 seconds as shown in the IMD section - Please see the Interchangeable Monitoring Device and/or Display section for addition information regarding how to enable/disable VLC mode.

**NOTE**

With the release of firmware version 3.3.0, Vertiv has added support for the VLC feature to all standard Metered and Monitored Vertiv Upgradeable products, as well as a significant majority of its engineered-to-order range. Certain custom models of Vertiv Upgradeable PDUs may not have VLC support within the Vertiv Mobile application. If your custom product is not supported by the Vertiv Mobile app it will be noted in the product specification sheet. Please contact your sales representative if you would like assistance with this.

Latest firmware updates can be found at <http://www.vertivco.com/Firmware-Support>.

**NOTE**

Vertiv Mobile app currently available via the App Store for iOS devices. Android version is available in the Play Store.

Removal

The IMD is designed to be field replaceable by **qualified service personnel only**. The IMD module is hot-swappable, meaning it is designed to be replaceable while the PDU is still connected to AC power.

	<p>NOTE</p> <p>Be sure to have the new IMD module ready for installation immediately after removal of the old IMD.</p>
---	---

1. Remove disposable ESD wrist strap from package, remove adhesive backing and attach to PDU, put wrist strap on arm.
2. Insert Vertiv IMD Removal Tool as shown. Be sure to press tool in level and press in until tool is flush with face of IMD. Some older versions may require overlays to be removed prior to inserting tool.
3. Carefully pull tool and IMD straight out about 2 inches. Remove tool from IMD.

	<p>CAUTION</p> <p>IMD is still connected internally. DO NOT pull IMD more than 2 inches (50mm) from chassis.</p>
---	--

4. Gently unplug the connector from the IMD.

Figure 3-3 IMD Removal Steps

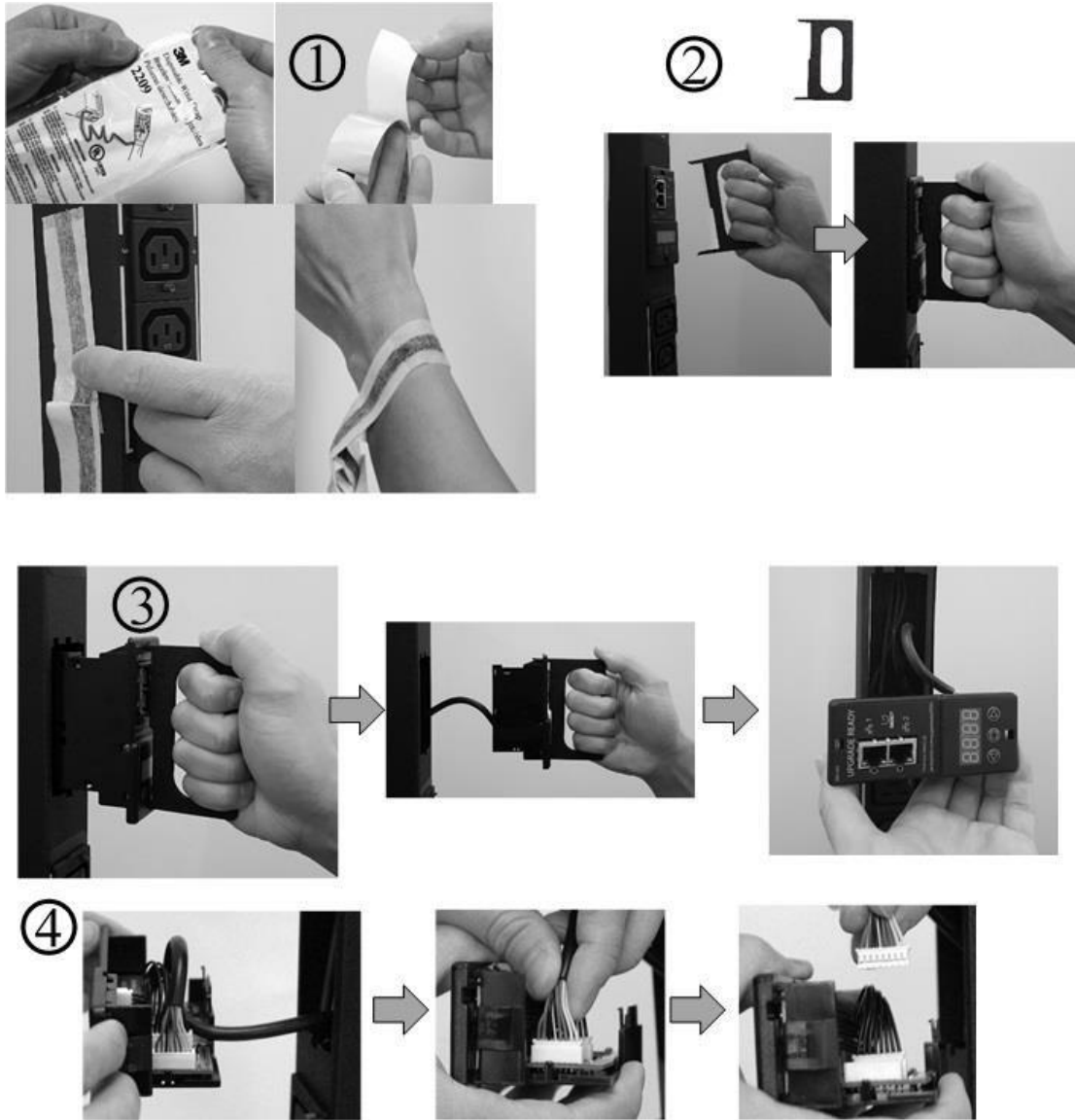

Installation

1. Connect the cable to the replacement IMD module.
2. Tuck the excess cable back into the PDU, and slide the IMD straight in.
3. Press with both thumbs until the IMD snaps into place.

Figure 3-4 IMD Installation Steps

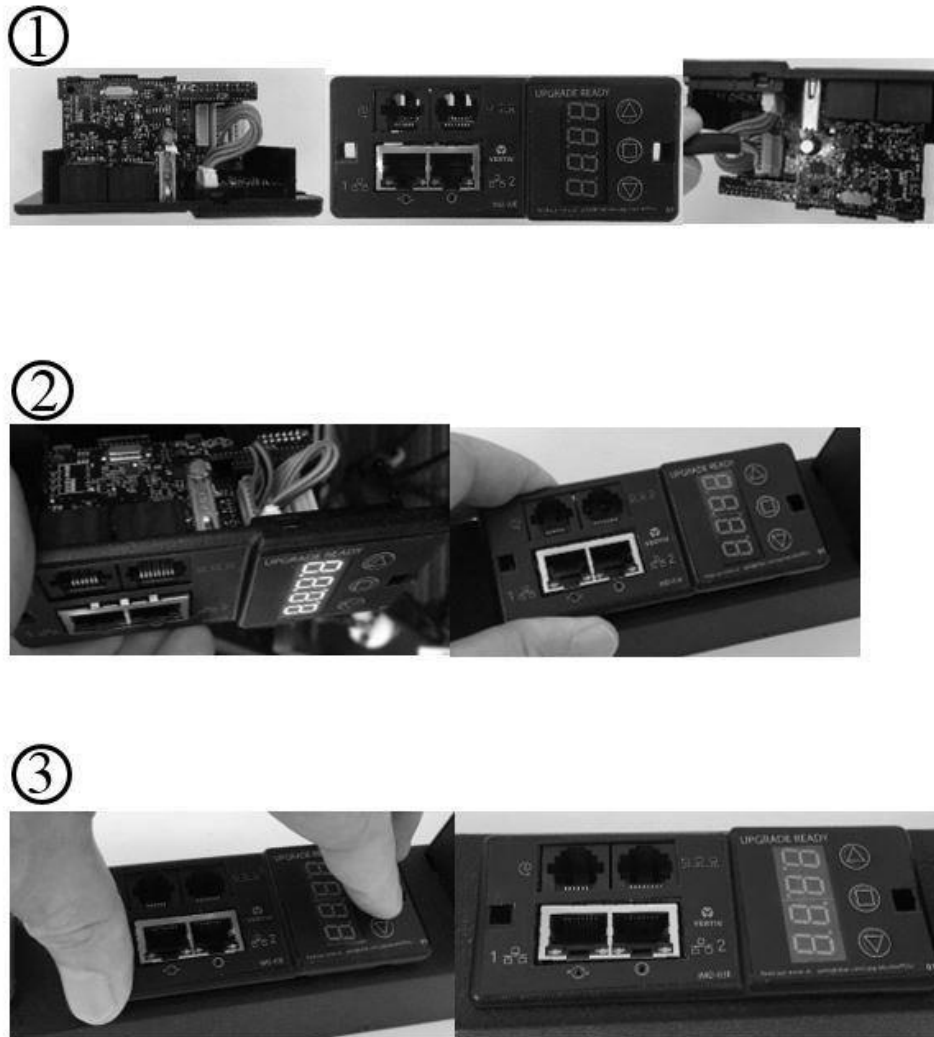

5.2. VERTIV MOBILE APP

Vertiv Mobile App

The Home screen allows the user to initiate a device scan or export data via .csv file.

Figure 3-5 Mobile App Home Screen

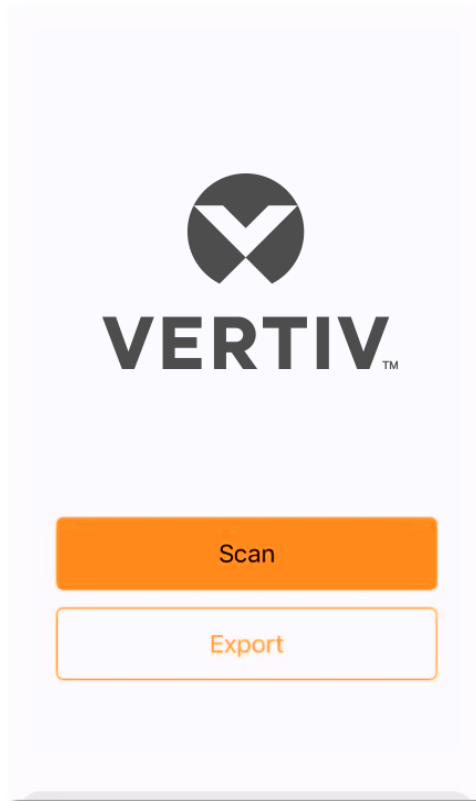

- **Scan:** Turns on scan mode to allow the app to capture VLC data from Vertiv Upgradeable PDU.
- **Export:** Pressing the export button will launch the smart device's email app and attach the Database .csv file to be emailed to desired recipients.

Scanning a PDU

Pressing the **Scan** button on the **Home** screen will load the Vertiv Mobile app scanning engine.

Figure 3-6 Mobile App Scanning Screen

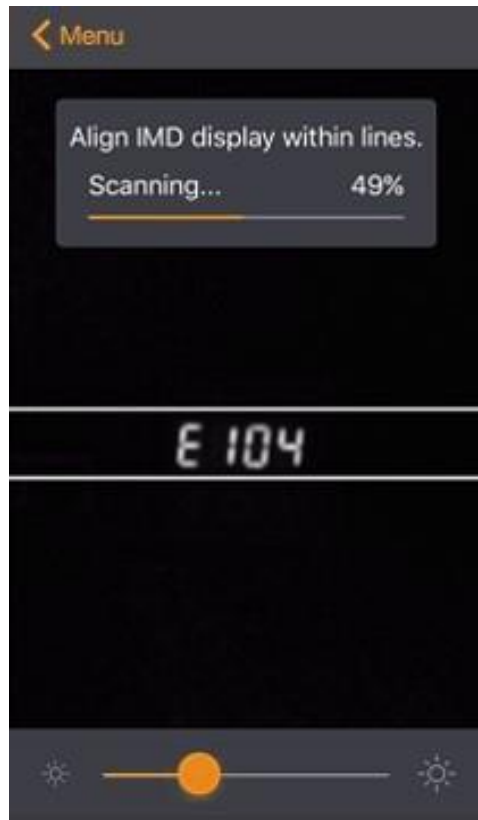

To scan the PDU, position the smart device so that the characters on the LED display are between the lines on the screen.

- The LED characters should be clear and in-focus. If the characters appear too bright or too dark, the exposure setting can be adjusted by using the sliding bar at the bottom of the screen.
- The app will begin to capture data as soon as it can see the LED characters inside the horizontal lines. Scan progress is displayed as a percentage. If the scan percentage is increasing slowly, or resetting, the device is having trouble reading the data properly. In this case, try re-positioning the device to improve results.
- After the scan reaches 100% the app will load the **Readings** page.

	<p>NOTE</p> <p>When a device is scanned for the first time, the Vertiv Mobile app will recognize the serial number as being new and ask if it should be added to the database as shown below. If added to the database, all future scanned data will be added to the device serial number record.</p>
---	--

Figure 3-7 Mobile App New Device Screen



Scanning tips:

The VLC feature relies upon light for its communication. If the lighting around the display or the lighting going through the lens of the smart device is not optimal then the OCR (Optical Character Recognition) will struggle to capture the data. When looking at the smart device screen during capture, you can see if the characters of the LED display are in focus and bright, if they are blurred, with a surrounding glow or are faint then the VLC capture will fail to work quickly and may be unable to scan at all.

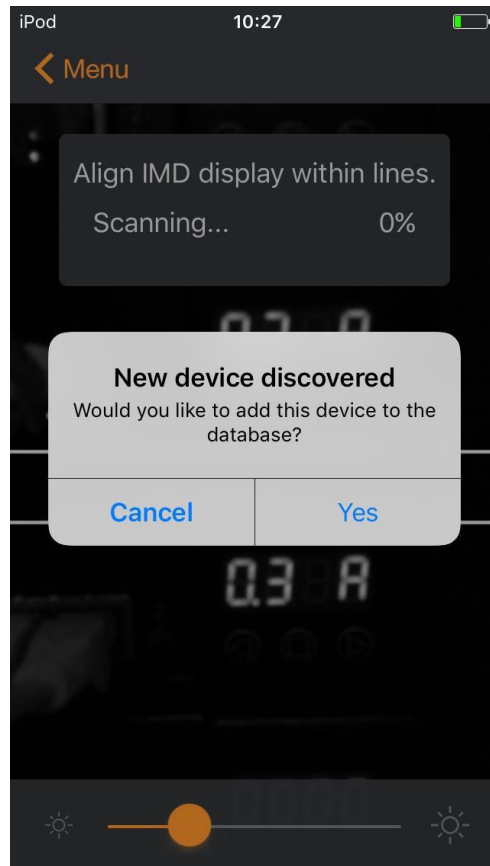
Proper capture methods:

Figure 3-8 Mobile App Capture Screen

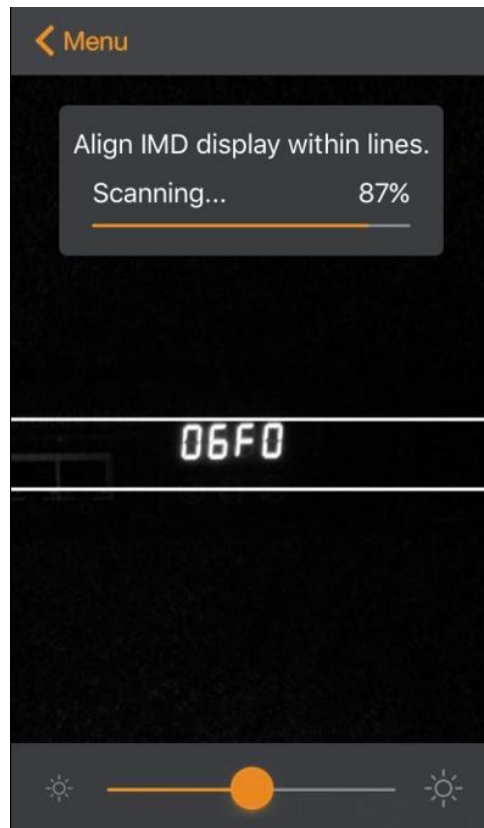

- High Contrast between LED display and background
- No glow around LED display characters
- LED display characters between horizontal guidelines

Improper capture methods:

Figure 3-9 Mobile App Capture Misalignment

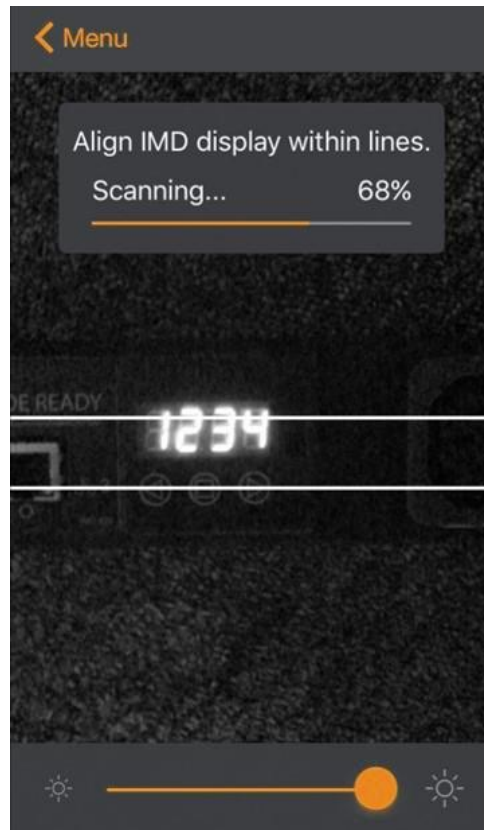

- Blurry image
- Over-exposed image
- Glow around LED display characters
- LED display characters not between horizontal guidelines

Failure modes & Error messages:

The Vertiv Mobile App will retry a scan 2 times if the scan cannot be completed. The scan can fail due to the smart device being unable to correctly capture all the VLC data correctly. If the app cannot properly capture the data, it will retry twice, or display one of the following messages:

Figure 3-10 Mobile App Scan Fail

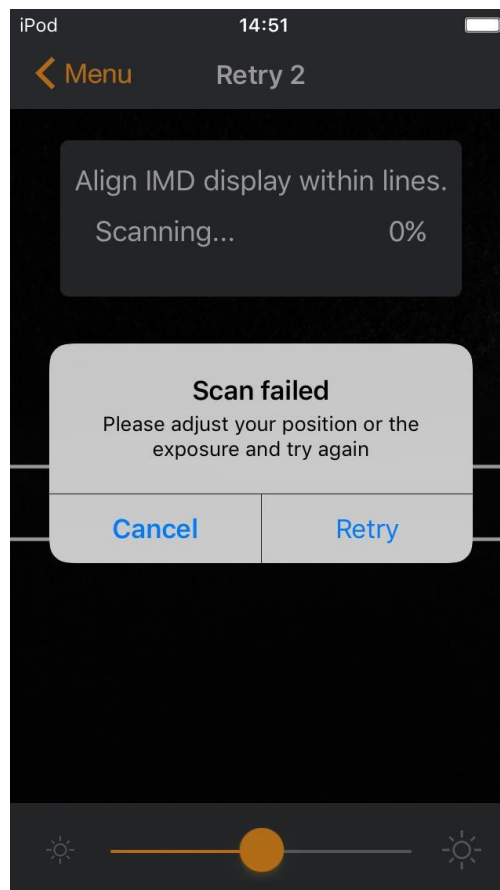

- Scan failed: Incorrect set configuration
- Scan failed: Incorrect data sequence
- Scan failed: Please adjust your position or the exposure and try again

Press cancel to return to the **Home** screen, or retry to return to the **Scan** page

Readings

The **Readings** page displays scan results for each PDU scanned using VLC.

Figure 3-11 Mobile App Readings Screen

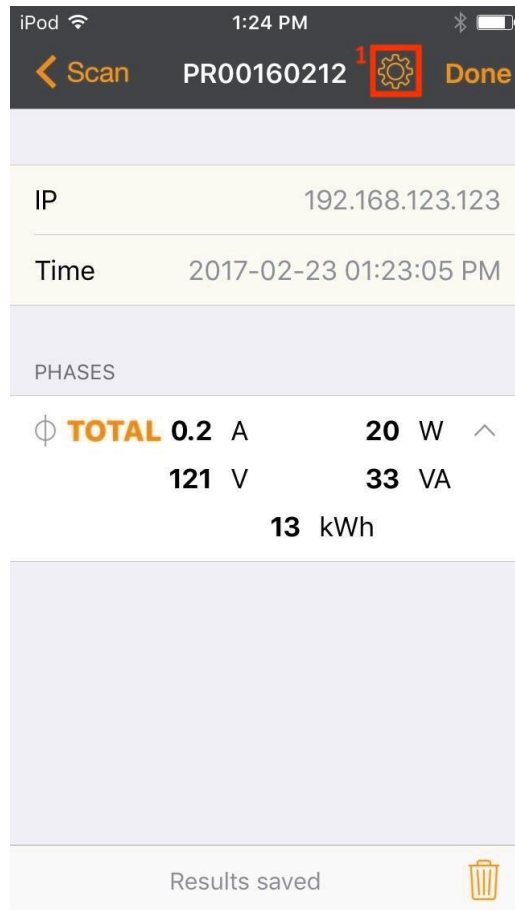

1. Pressing the Settings  button will enable the user to customized the data that is displayed in the scan results.



NOTE

The unit serial number is displayed in the title bar of the **Readings** page. This serial number will match the serial number located on the surface of the PDU.

Figure 3-12 Mobile App Settings Screen

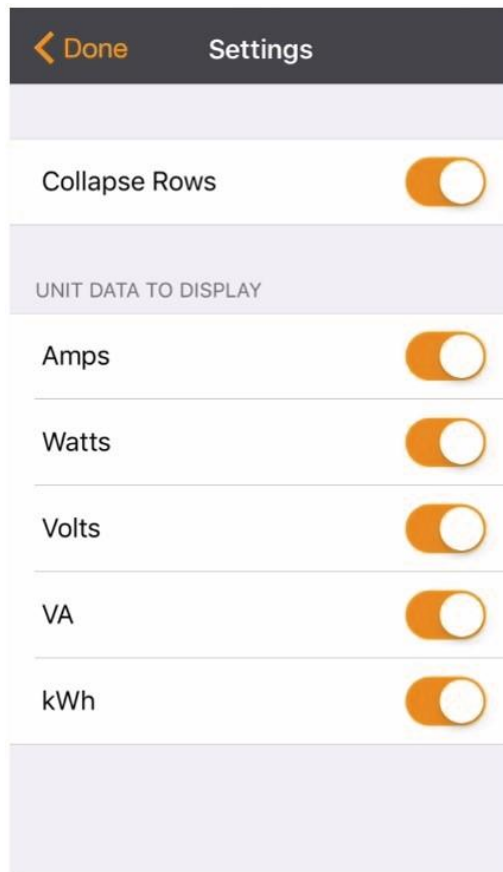

- **Collapse Rows:** Allows user to collapse or expand the **Readings** page to help properly display data on smart devices with smaller screens.
- **Unit Data to Display:** Selects which data is shown on the **Readings** page. All data is stored within the database regardless of settings here. These settings are global and will apply to any scanned unit.

Export

The **Export** button on the **Home** screen will open the smart device's default email app to send the database of scanned devices in .csv format to the desired recipients.

Figure 3-13 Mobile App Export Screen

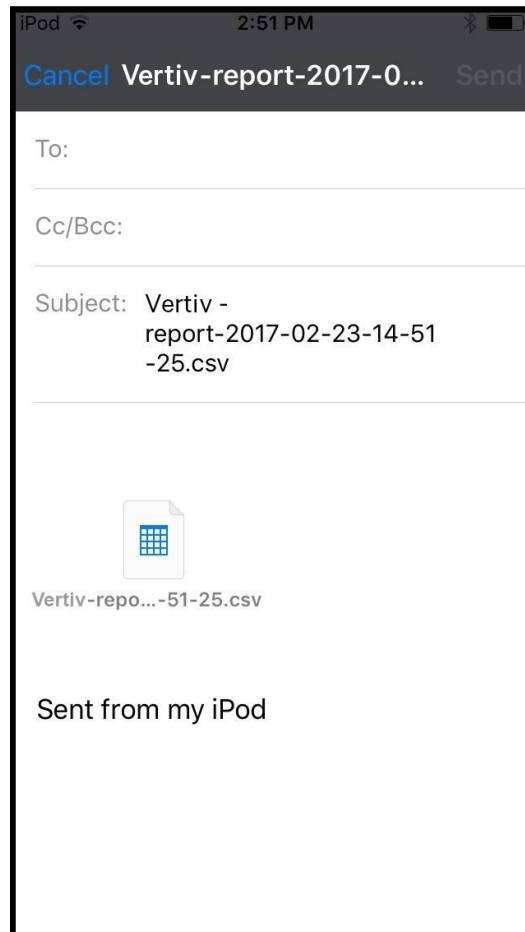

NOTE

An email app must be properly configured on the smart device to utilize the Export function. The Vertiv Mobile app does not directly support email functionality. Vertiv cannot troubleshoot email errors as this would be an issue with either the device, or email service being used.

Each PDU you scan adds a new entry to the database, there is no limit to the number of individual PDU's that can be added but the database has a limit of 10 scans per PDU. Additional scans of the unit will overwrite the oldest data for that unit.

The **.csv** data output organizes data first by serial number and then by date & time. You can further organize the data by using the 'Filter' option in Excel.

The data structure is split into two sections:

1. PDU configuration data includes:

- Serial Number
- Frame Definition
- Date/Time stamp
- IPv4 address

2. Power Data includes:

- Power Readings
- Totals

Table 3-1 CSV Data

PDU Configuration Data			
Serial#	FrameDef	YYYY-MM-DD-HH-MM-SS	IP Add
Products unique serial number. This is the same serial number present on the units label.	Part of the VLC configuration data and used for debugging.	Timestamp of when the scan occurred.	The IPv4 address of the unit. Locally Metered units will show Null IP address.

Power Data				
1 Volts	1 Amps	1 Watts	1 VA	1 kWh
Input Phase for Single Phase units. Phase A or Phase AB if 3 Phase	Phase Amperes	Phase Real Power	Phase Apparent Power	Phase Kilowatt-Hours
2 Volts	2 Amps	2 Watts	2 VA	2 kWh
Phase B or Phase BC if 3 Phase	Phase Amperes	Phase Real Power	Phase Apparent Power	Phase Kilowatt-Hours
3 Volts	3 Amps	3 Watts	3 VA	3 kWh
Phase C or Phase AC if 3 Phase	Phase Amperes	Phase Real Power	Phase Apparent Power	Phase Kilowatt-Hours

Some GU models have Dual Inputs with Monitoring or Dual Inline Monitoring, these units can have up to three additional Power readings				
4 Volts	4 Amps	4 Watts	4 VA	4 kWh
Secondary Input Phase for Single Phase units. Phase A or Phase AB if 3 Phase	Phase Amperes	Phase Real Power	Phase Apparent Power	Phase Kilowatt-Hours
5 Volts	5 Amps	5 Watts	5 VA	5 kWh
Secondary Phase B or Phase BC if 3 Phase	Phase Amperes	Phase Real Power	Phase Apparent Power	Phase Kilowatt-Hours
6 Volts	6 Amps	6 Watts	6 VA	6 kWh
Secondary Phase C or Phase AC if 3 Phase	Phase Amperes	Phase Real Power	Phase Apparent Power	Phase Kilowatt-Hours

Breakers / Circuits					
Breaker 1	Breaker 2	Breaker 3	Breaker 4	Breaker 5	Breaker 6
Breaker / Circuit 1 Amps	Breaker / Circuit 2 Amps	Breaker / Circuit 3 Amps	Breaker / Circuit 4 Amps	Breaker / Circuit 5 Amps	Breaker / Circuit 6 Amps

Total(s)		
Total Watts (Real Power)	Total VA (Apparent Power)	Total kWh
The total of Watts shown in sections 1-6	The total of VA shown in sections 1-6	The total kWh shown in sections 1-6

	<p>NOTE</p> <p>The above table is an outline of data that is present in the database .csv file as is not representative of the actual format of the .csv file. Data stored will vary based on product configuration.</p>
---	---

5.3.WEB INTERFACE

The Vertiv Upgradeable Monitored units come with an embedded web interface. The unit is accessible via a standard, unencrypted HTTP connection, or via an encrypted HTTPS (TLS) connection.



NOTE

An administrator account (username and password) must be created when logging onto the device for the first time.

5.4. SENSORS

5.4.1. OVERVIEW

The Sensors Overview page displays the PDU's data. Vertiv Upgradeable PDUs measure power, voltage, current and energy. Readings on the Overview page are provided in real-time for all of the unit's measurements.

Figure 3-14 GU2 Overview Page

State	Label	Energy (kWh)	Real Power (W)	Apparent Power (VA)	Power Factor (%)	Voltage (VRMS)	Voltage Min (VRMS)	Voltage Max (VRMS)	Peak Voltage (V)	Current (ARMS)	Current Min (ARMS)	Current Max (ARMS)	Peak Current (A)
	Phase A	11.64	5	9	52	126.2	122.0	128.5	185.5	0.07	0.06	0.08	0.80

State	Label	Current (ARMS)	Current Min (ARMS)	Current Max (ARMS)	Peak Current (A)
	Circuit 1	0.00	0.00	0.00	0.00

State	Label	Energy (kWh)	Real Power (W)	Apparent Power (VA)	Power Factor (%)	Voltage (VRMS)	Voltage Min (VRMS)	Voltage Max (VRMS)	Peak Voltage (V)	Current (ARMS)	Current Min (ARMS)	Current Max (ARMS)	Peak Current (A)
✗	Outlet 1	0.000	0	0	10	0.0	0.0	123.7	175.3	0.00	0.00	0.00	0.00
✓	Outlet 2	0.000	0	0	10	121.9	0.0	124.1	178.8	0.00	0.00	0.00	0.00
✓	Outlet 3	0.000	0	0	10	121.9	0.0	124.2	178.9	0.00	0.00	0.00	0.00
✓	Outlet 4	0.000	0	0	10	122.0	0.0	124.2	179.0	0.00	0.00	0.00	0.00
✓	Outlet 5	0.000	0	0	10	122.0	0.0	124.3	179.0	0.00	0.00	0.00	0.00
✓	Outlet 6	0.000	0	0	10	121.9	0.0	124.1	178.8	0.00	0.00	0.00	0.00

1. Vertiv Logo

- Clicking on this logo from any page will reload the Sensor Overview page.

2. Sensors, System, and Help Tabs

- Mouse over to show sub-menus:

Table 3-2 Sensors, System, and Help Tabs

Sensors	System			Help
Overview	Users	Display	Syslog	Info
Alarms & Warnings	Network	Time	Admin	Support Site
Logging	Web Server	SSH	Locale	
	Reports	Email	Utilities	
	LDAP	SNMP		

3. Log In / Log Out

- Click to log in or log out of the unit. Note that both user-name and password are case sensitive; prohibited characters are: \$&`:<>[] { } "+%@/ ; =?^|~',

4. Alarms and Warnings

- Indicates the number of Alarms and Warnings currently occurring, if any.

5. Device Label

- Displays the user-assigned label of this unit (see "Configuration and Operation")

6. Device ID

- Unique product identification. May be required for technical support.

7. Total and Individual Phase or Line Monitor

- Displays AC current, voltage, and power statistics for each individual phase, phase pair, and for the total of all phases combined.

8. Circuit Current

- Displays AC current draw for each Circuit/Breaker on the PDU.

9. Outlet

- Displays AC current, voltage and power statistics for each circuit and outlet. (Outlet Level Power Monitoring and Switched Outlet Level Monitoring Only)
- Displays outlet status. (Switched and Switched Outlet Level Monitoring Only)



NOTE

Groupings for Total, Phase, Circuit and Outlet Monitoring will vary depending on the PDU's configuration and wiring.

5.4.1.1. CONFIGURATION AND OPERATION



Configuration Icon



Operation Icon



NOTE

Only users with control or admin level authorizations have access to these settings.

Device, Phase and Circuit Configuration:

1. Click the desired Configuration icon to change the device's **Label**. **Name** is the PDU's factory name or model, and cannot be changed.
2. Once done, click **Save**.

Figure 3-15 Device, Phase and Circuit Configuration Page

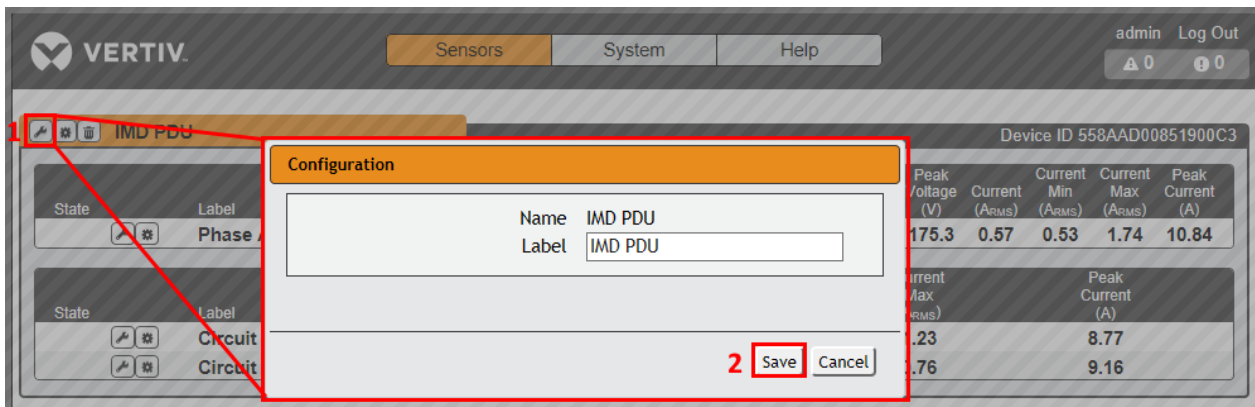

Outlet Configuration:

1. Click the desired Outlet Configuration icon.

Figure 3-16 Outlet Configuration Page

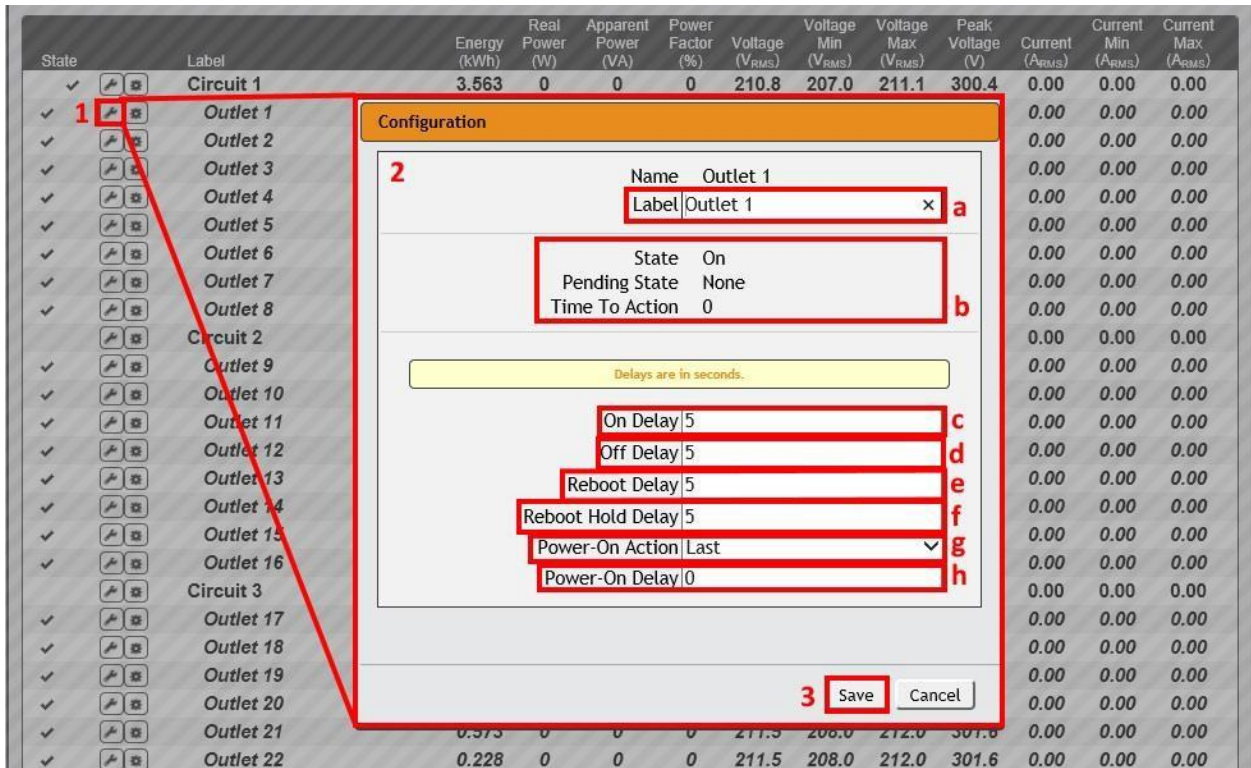

2. Configuration pop-up box will appear.
 - a. Use the text box to change the outlet's **Label**.
 - b. The outlet's state is described by three descriptors:
 - **State** describes the outlet's current state (On/Off).
 - **Pending State** describes the state the outlet is currently transitioning to, if it is in the process of switching.
 - **Time To Action** describes the time left before the pending action will take place. This is adjusted using **Delays**.
 - c. **On Delay** is the time, in seconds, the unit waits before switching an outlet on. d.
 - Off Delay** is the time, in seconds, the unit waits before switching an outlet off. e.
 - Reboot Delay** is the time, in seconds, the unit waits before rebooting an outlet.
 - f. **Reboot Hold Delay** is the time, in seconds, the unit waits after switching the outlet off, before switching an outlet back on during a reboot.
 - g. **Power-On Action** describes the state the outlet will start at power-on (On, Off or Last).
 - h. **Power-On Delay** is the time, in seconds, the unit waits after power-on before performing the power-on action for the outlet.

3. Click the **Save** button if any settings are changed.

Device Operation:

1. Click the Operation icon.

Figure 3-17 Device Operation Page

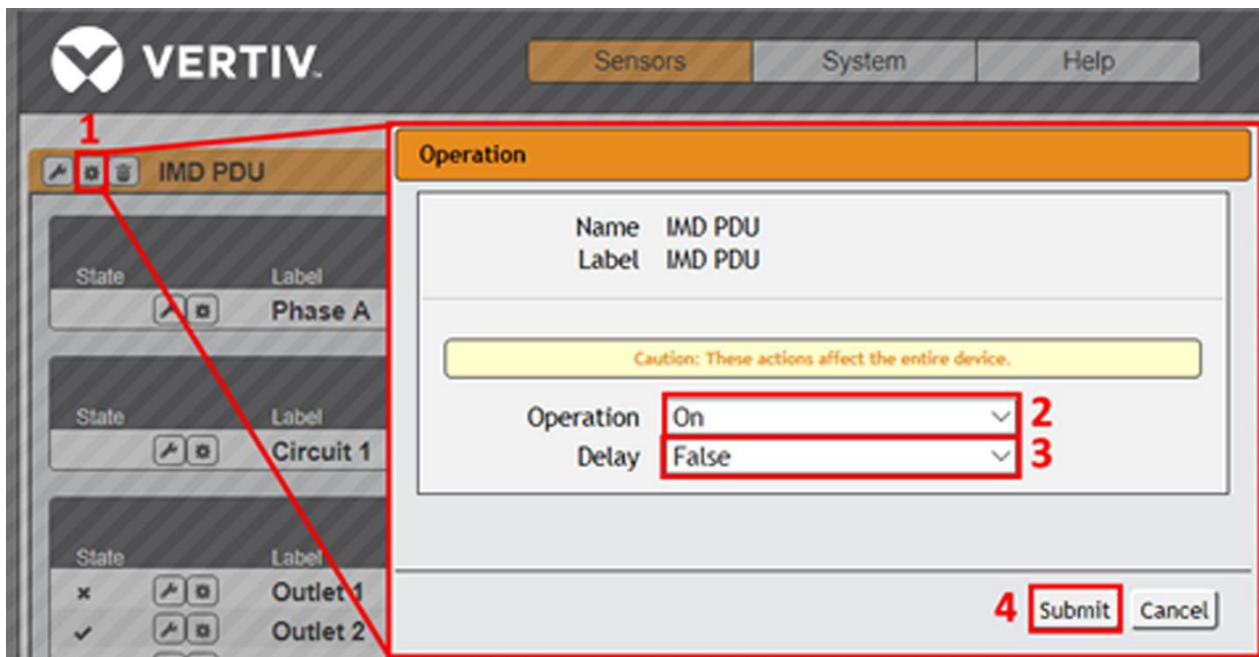

2. Select the operation you wish to perform:

- **On/Off** turns on/off all outlets.
- For outlets currently on, **Reboot** cycles the outlets off, then back on after the reboot hold delay. For outlets currently off, **Reboot** turns the outlets on.
- **Cancel** will cancel the current operation if it has not been completed yet.
- **Reset Energy** will reset the total Energy measured in kWh.
- **Reset Min Max Values** resets all Min and Max values for Current and Voltage measurements.
- **Restore Defaults** will restore device settings to their factory default. This includes Labels, Delays and Power-On Actions for the device.



CAUTION

These actions affect the entire device.

3. For operations involving the state of the outlets, setting **Delay** to True will use the current **Delay** configuration for each outlet when performing the selected operation.
4. Select **Submit** to issue the action.

	NOTE
Power-on action delays reference the time since the unit was plugged in, not the time since it fully booted. They may execute before the unit fully boots.	

Circuit Operation:

1. Click the Operation icon. For Circuit operation only the Reset Min Max Values operation is available.
2. Click the **Submit** button to reset the Min Max Values of the Circuit.

Figure 3-18 Circuit Operation Page



Outlet Operation:

1. Click the desired Outlet Operation icon.

Figure 3-19 Outlet Operation Page

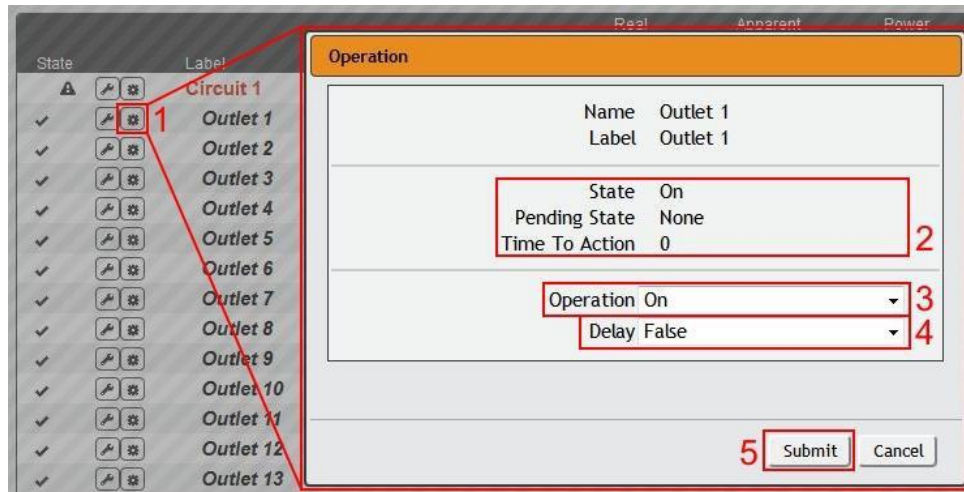

2. The outlet's state is described by three descriptors:
 - **State** describes the outlet's current state (On/Off).
 - **Pending State** describes the state the outlet is currently transitioning to, if it is in the process of switching.
 - **Time To Action** describes the time left before the pending action will take place. This is adjusted using **Delays**.
3. Select the operation you wish to perform:
 - **On/Off** turns on/off the selected outlet.
 - For an outlet currently on, **Reboot** cycles the outlet off, then back on after the reboot hold delay. For an outlet currently off, **Reboot** turns the outlet on.
 - **Cancel** will cancel the current operation if it has not been completed yet.
 - **Reset Energy** will reset the total Energy measured in kWh for the selected outlet.
 - **Reset Min Max Values** will reset Min and Max values for Voltage and Current
4. For operations involving the state of the outlet, setting **Delay** to True will use the current **Delay** configuration for each outlet when performing the selected operation. Delays are configured in "Outlet Configuration".
5. Select **Submit** to issue the action.

5.4.2. ALARMS & WARNINGS

The Alarms & Warnings page allows users to establish alarm or warning conditions (hereafter referred to as "Events") for each power, circuit and outlet readings. Events are triggered when a measurement exceeds a user-defined threshold, either going above the threshold ("high-trip") or below it ("low-trip").

Events are displayed in different sections, based on the device or measurement the Event is associated with. Each Event can have one or more Actions to be taken when the Event occurs.

Figure 3-20 Alarms & Warnings Page

Alarms & Warnings										
State				Label	Trigger	Severity	Type	Value	Valid Time	Notify
1 !	2 +	3 ✎	4 ☑	IMD PDU Phase A	Voltage	Alarm	High	115	—	[0]

1. **State:** Shows the status of each Event.

- Empty: No alert condition.
- ! : This symbol indicates that this particular "Warning" Event has been tripped. A tripped Warning Event displays in orange.
- ⚠ : This symbol indicates that this particular "Alarm" Event has been tripped. A tripped Alarm Event displays in red.
- ✓ : This symbol will indicate that this Event has not yet been acknowledged by a user after being tripped. It will remain this way until the condition being measured by this Event returns to normal (i.e. ceases to exceed the trigger threshold for this Event.) or the user has clicked the button to acknowledge the Event.

2. **Configuration:** Add/Delete/Modify Alarms & Warnings.

- + : Add new Alarms & Warnings.
- ✎ : Modify existing Alarms & Warnings.
- 🗑 : Delete existing Alarms & Warnings.

3. **Notification:** Notify user of tripped Events, and request acknowledgment.

- Empty: If the ☑ is not present, it means that no alert condition is present or the Event has been acknowledged.
- ☑ : Acknowledge button. When a Warning or Alarm Event has occurred; the user can click on this symbol to acknowledge the Event and stop the unit from sending any more notifications about it.



NOTE

Clicking this symbol does not clear the Warning or Alarm Event, it just stops the notifications from repeating and removes it from the active Event list.

4. The actual conditions for the various Alarms & Warnings settings are shown here.

5.4.2.1. ALARMS & WARNINGS CONFIGURATION

To add a new Alarm or Warning Event:

1. Click the Add/Modify Alarms & Warnings button:

 Figure 3-21 Add/Modify Alarms & Warnings Page

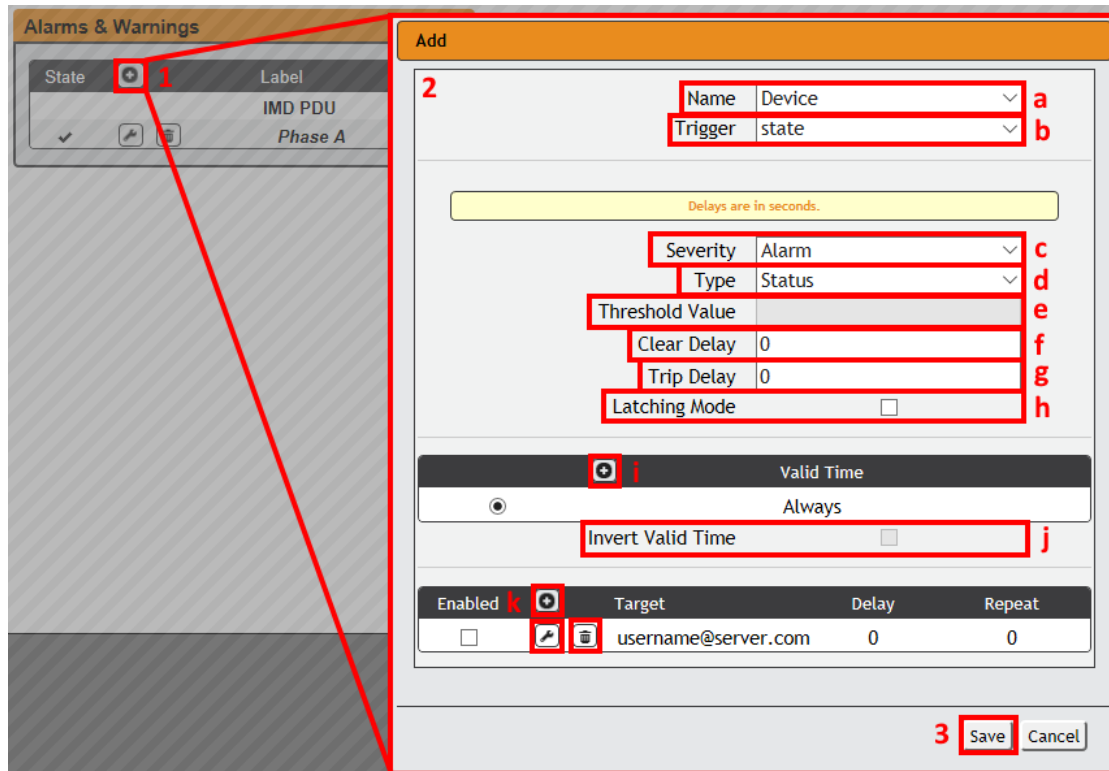

2. Set the desired conditions for this Event as follows:
 - a. Select the **Name** of the phase or circuit you wish to set an Event on.
 - b. Select the measurement (current, voltage, etc.) you want to **Trigger** the Event.
 - c. Set the **Severity** level ("Warning", or "Alarm") for this Event.
 - d. Select the threshold **Type**, "Status" (trips if device status changes), "high" (trips if the measurement goes above the threshold) or "low" (trips if the measurement goes below the threshold).
 - e. Type in the desired **Threshold Value** (any number between -999.0 ~ 999.0 is valid).
 - f. Type in the desired **Clear Delay** time in seconds. Any value other than "0" means that once this Event is tripped, the measurement must return to normal for this many seconds before the Event will clear and reset. Clear Delay can be up to 14400 seconds (4 hours).
 - g. Type in the desired **Trip Delay** time in seconds. Any value other than "0" means that the measurement must exceed the threshold for this many seconds before the Event will be tripped. Trip Delay can be up to 14400 seconds (4 hours).
 - h. **Latching Mode**: If enabled, this Event and its associated Actions remain active until the Event is acknowledged, even if the measurement subsequently returns to normal.
 - i. **Valid Time** decides when an Alarm notification can be sent. **Valid Time** is set by clicking the Add/Modify icon and setting the days and time ranges notifications will be sent. Then clicking **Save**.

	<h2 style="margin: 0;">NOTE</h2> <p style="margin: 0;">Only one valid time can be selected per alarm.</p>
---	---

Figure 3-22 Add Event Time



- j. The **Invert Valid Time** check box inverts the selected **Valid Time** setting.
- k. To determine where the alert notifications will be sent to when this particular Alarm or Warning Event occurs, click the Add icon to create a new Action, then select the desired options from the drop-down menu:

Figure 3-23 Add New Action

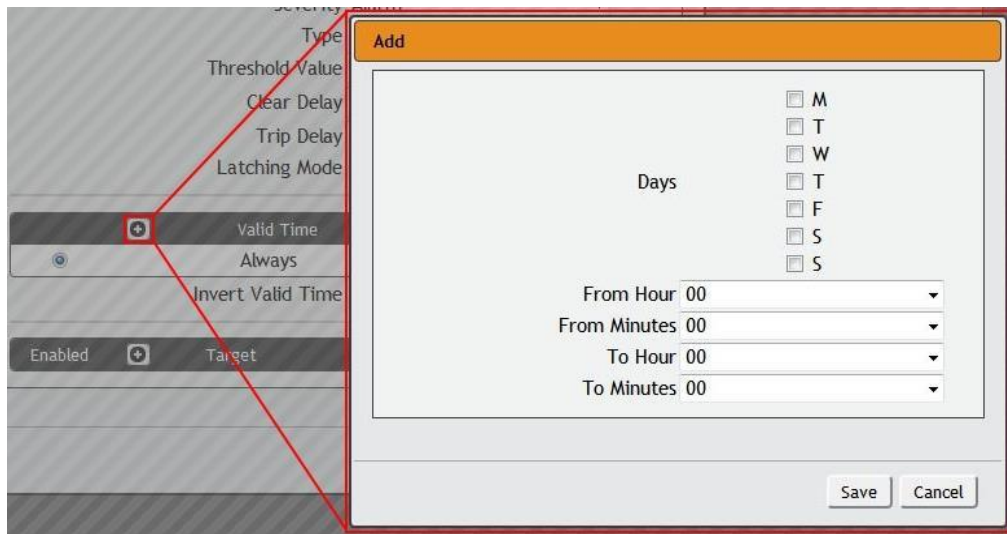
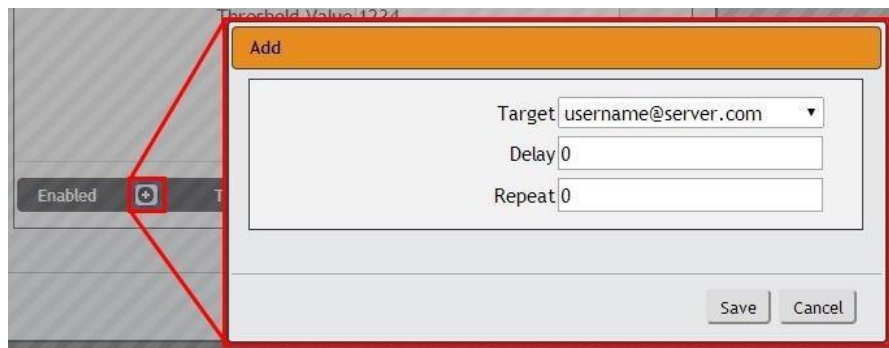

- **Target** is the e-mail address or SNMP manager to which notifications should be sent when the Event is tripped. Other options, such as "buzzer", may be available depending on your Vertiv PDU.
- **Delay** determines how long this Event must remain tripped before this Action's first notification is sent. (Note that this is different from the Trip Delay, above; Trip Delay determines how long the threshold value has to be exceeded before the Event itself is tripped.) **Delay** can be up to 14400 seconds (4 hours). A **Delay** of 0 will send the notification immediately.
- **Repeat** determines whether multiple notifications will be sent for this Event Action. **Repeat** notifications are sent at the specified intervals until the Event is acknowledged, or until the Event is cleared and reset. The **Repeat** interval can be up to 14400 seconds (4 hours). A **Repeat** of 0 disables this feature, and only one notification will be sent.

Then, click **Save** to save this notification Action.

If required, multiple Actions can be set for an Alarm or Warning; to add multiple Actions click the Add icon again and set each one as desired. Each alert can have up to 32 Actions associated with it.

To change an existing notification Action, click the Modify icon next to the Action you wish to change, then modify its settings as above.

Figure 3-24 Modify Action

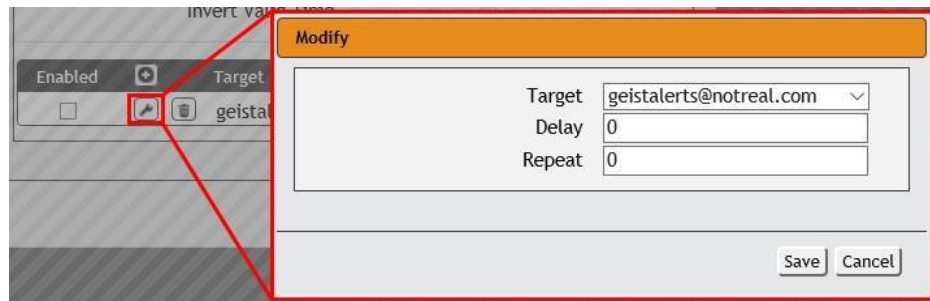

Once an Action has been added, each Action has its own checkbox in the "enabled" column at the far left. The default is unchecked (disabled) when you first add each Action; set the checkbox to enable it. (This allows you to selectively turn different Actions on and off for testing.)

To remove a notification Action entirely, click the Delete icon to remove the Action from the list, then click **Delete** to confirm:

Figure 3-25 Delete Action

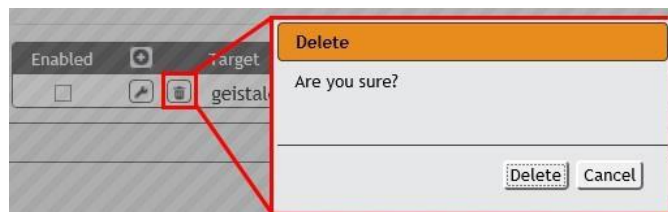

3. When finished, click **Save** to save this Alarm or Warning event.

To change an existing Alarm or Warning Event:

Click the Modify icon next to the Alarm or Warning Event you wish to change, then modify its settings as above.

To delete an existing Alarm or Warning Event:

Click the Delete icon next to the Alarm or Warning Event you wish to change, then click **Delete** to confirm.

5.4.3. LOGGING

The Logging page allows the user to access the historical data recorded by the PDU by selecting the desired sensors and time range to be logged.

Figure 3-26 Logging Page

The screenshot displays the 'Logging' page for an IMD PDU. It is divided into three main sections:

- Data Log Section:** Contains options to download the data log in JSON or CSV format. A warning states: 'Warning: Changing the interval clears the log.' Below this is a 'Log Interval (minutes)' input field set to 15, with a 'Save' button. At the bottom is a 'Clear the Log' button.
- Logging Section:** Features a 'Click a measurement value to select or deselect.' warning and a 'Save' button.
- IMD PDU Section:** Shows the device ID 'C436AD00851900C3' and three data tables.

State	Label	Energy (kWh)	Real Power (W)	Apparent Power (VA)	Power Factor (%)	Voltage (V _{RMS})	Voltage Min (V _{RMS})	Voltage Max (V _{RMS})	Peak Voltage (V)	Current (A _{RMS})	Current Min (A _{RMS})	Current Max (A _{RMS})	Peak Current (A)
▲	Phase A	11.649	5	9	52	126.2	122.0	128.5	185.5	0.07	0.06	0.08	0.80

State	Label	Current (A _{RMS})	Current Min (A _{RMS})	Current Max (A _{RMS})	Peak Current (A)
	Circuit 1	0.00	0.00	0.00	0.00

State	Label	Energy (kWh)	Real Power (W)	Apparent Power (VA)	Power Factor (%)	Voltage (V _{RMS})	Voltage Min (V _{RMS})	Voltage Max (V _{RMS})	Peak Voltage (V)	Current (A _{RMS})	Current Min (A _{RMS})	Current Max (A _{RMS})	Peak Current (A)
×	Outlet 1	0.000	0	0	10	0.0	0.0	123.7	175.3	0.00	0.00	0.00	0.00
✓	Outlet 2	0.000	0	0	10	121.9	0.0	124.1	178.8	0.00	0.00	0.00	0.00
✓	Outlet 3	0.000	0	0	10	121.9	0.0	124.2	178.9	0.00	0.00	0.00	0.00
✓	Outlet 4	0.000	0	0	10	122.0	0.0	124.2	179.0	0.00	0.00	0.00	0.00
✓	Outlet 5	0.000	0	0	10	122.1	0.0	124.3	179.0	0.00	0.00	0.00	0.00
✓	Outlet 6	0.000	0	0	10	121.9	0.0	124.1	178.8	0.00	0.00	0.00	0.00

1. Data Log Download

- Clicking on the **JSON** link will download the data log in JSON format.

- Clicking on the **CSV** link will download the data log in .csv format for use in spreadsheet software such as Microsoft Excel.

2. Log Interval

- Change the frequency at which data is written to the log file. The logging interval can be 1-600 minutes with the default setting being 15 minutes.



NOTE

Changing the log interval will result in the data log being cleared. Please download existing log data prior to changing log interval.

3. Clear Log Data

- Click on the Clear the Log button to delete log file.

4. Logging

- Click measurement value to select or deselect desired logging parameters. All measurements are selected by default.
- Press Save button to save changes



NOTE

Maximum loggable time frame is determined by number of measurements being logged and the interval at which data is written to the log file.

5.5.SYSTEM

5.5.1. USERS

The Users page in the System menu allows you to manage or restrict access to the unit's features by creating accounts for different users.

Figure 3-27 User Account Page

User Accounts				
	Username	Admin	Control	Enabled
1	guest			✓
2	Vertiv	✓	✓	✓
3	VertivDemo		✓	✓

There are three buttons available on the User Accounts page:

1. Add New User Account
2. Modify User's Account
3. Delete User's Account



NOTE

Only an Administrator-level account can Add, Modify, or Delete users. Control-level and View-Only accounts can change their own passwords via the Modify button, but cannot Add or Delete accounts, or Modify other accounts. The Guest account cannot Add, Delete, or Modify any account, not even itself.

To Add a user Account:

1. Click the Add User icon.

Figure 3-28 Add User Account Page

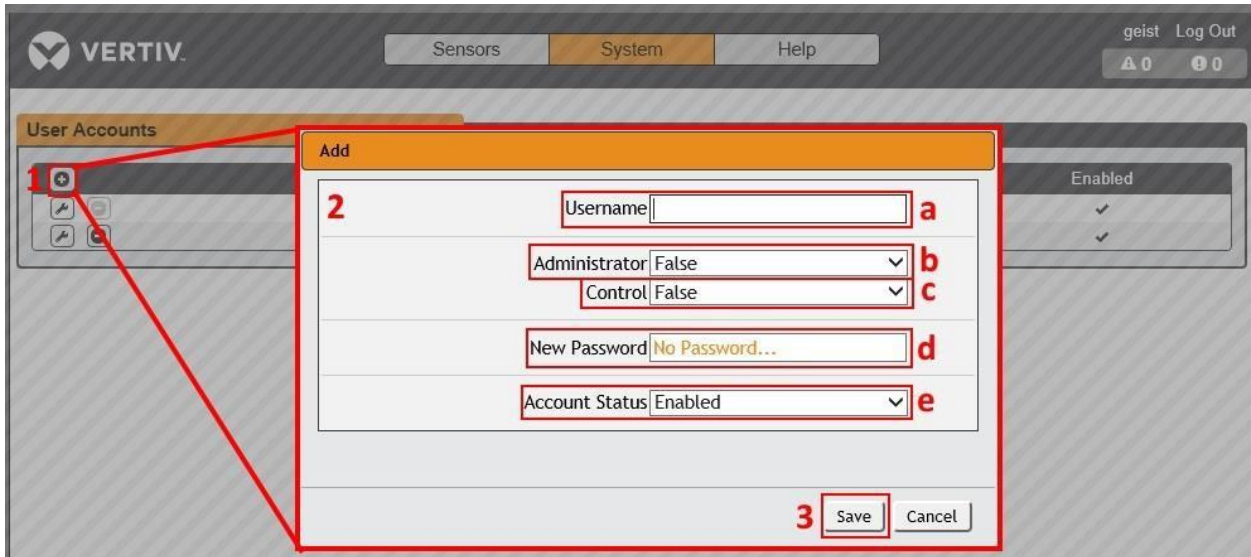

2. Create the account information as follows:

- a. **Username:** the name of this account. Must be 1 to 32 characters in length. The first character must be 'a'-'z'. Subsequent characters must be 'a'-'z', '0'-'9', '-' or '_'
- b. **Administrator:** if set to True, this account has Administrator-level access to the unit, and can change any setting.
- c. **Control:** if set to True, this account has Control-level access. Setting Administrator to True will automatically set Control to True as well. Setting this to False makes the account a View-Only account.
- d. **New Password:** account passwords may be up to 24 characters long, are case-sensitive, and may not contain spaces.



NOTE

Strong passwords typically contain at least 8 characters with a mix of Alpha (lower and upper case), numeric, and special characters.

- e. **Account Status:** set the account to Enabled or Disabled. Disabling an account prevents it from being used to log in, but does not delete it from the account list.

3. Click the **Save** button when finished.

Account Types:

- **Administrator:** Administrator accounts (accounts with both Administrator and Control authority set to True, as above) have full control over all available functions and settings on the device, including the ability to modify System settings and add, modify, or delete other users' accounts.

- **Control:** Control accounts (accounts with only Control set to True) have control over all settings pertaining to the device's sensors. They can add, modify, or delete Alarms & Warning Events and notification Actions, and can change the names or labels of the device and its sensors. Control accounts cannot, however, modify System settings or make changes to other users' accounts.
- **View:** If both Administrator and Control are set to False, the account is a View-Only account. The only changes a View-Only account is permitted to make are changing their own account's password, and changing the preferred language for their own account. View-Only accounts cannot change any device or system settings.
- **Guest:** Anyone who brings up the unit's web page without logging in will automatically be viewing the unit as Guest. By default, the Guest account is a View-Only account, and cannot make changes to any settings, although the Administrator can elevate the Guest account to Control-level access if desired, allowing anyone to make changes to names, labels, alarm events, and notifications without logging in. The Guest account cannot be deleted but can be disabled to require login for viewing system status.



NOTE

Once a user has logged in to their account, they can change their password or language preference by clicking their username, shown next to the Log Out hyperlink at the top right-hand corner of the web page.

To Modify a user Account:

1. Click the Modify User icon.

Figure 3-29 Modify User Page

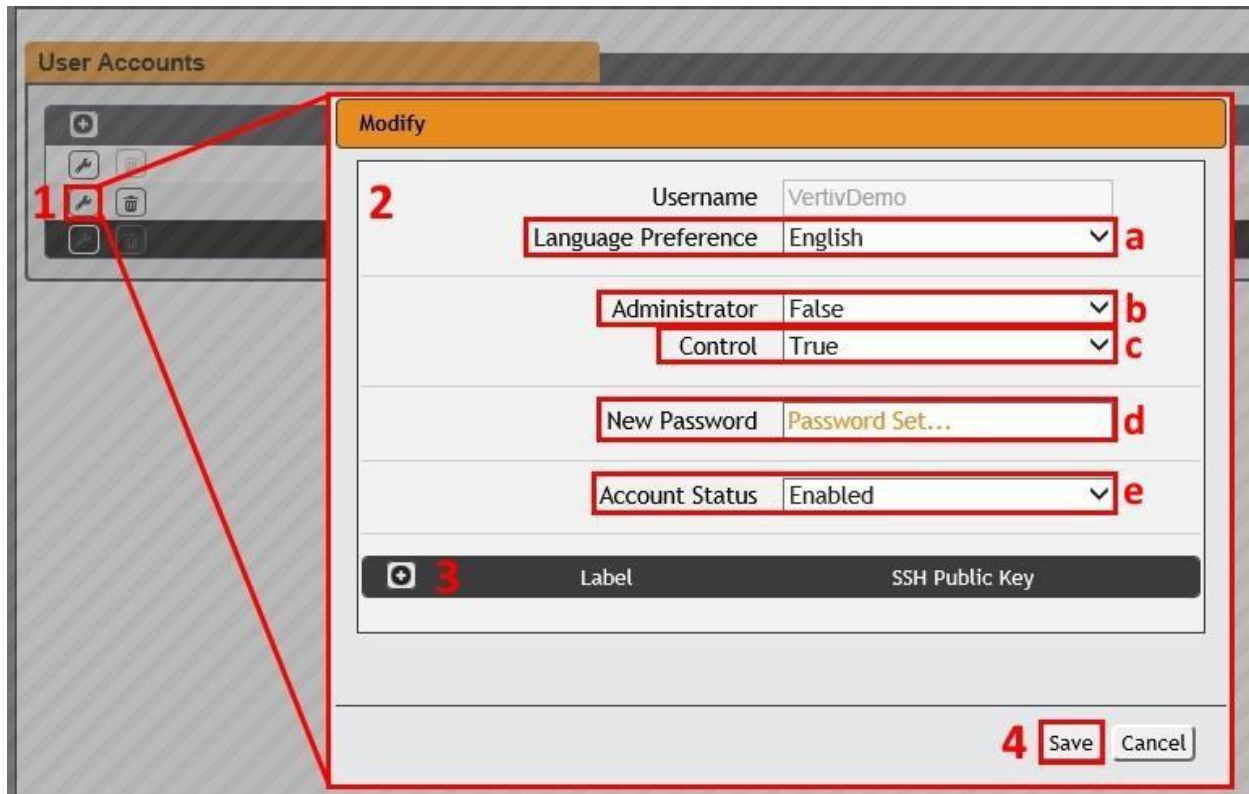

2. Modify the account information as follows:

- Language preference:** Change the default language for this user. Options are English, French, Spanish, German, Portuguese, Japanese, Chinese and Korean.
- Administrator:** if set to True, this account has Administrator-level access to the unit, and can change any setting. This option can only be modified by an Administrator level account.
- Control:** if set to True, this account has Control-level access. Setting Administrator to True will automatically set Control to True as well. Setting this to False makes the account a View-Only account. This option can only be modified by an Administrator level account.
- New Password:** account passwords may be up to 24 characters long, are case-sensitive, and may not contain spaces.



NOTE

Strong passwords typically contain at least 8 characters with a mix of Alpha (lower and upper case), numeric, and special characters.

- e. **Account Status:** set the account to Enabled or Disabled. Disabling an account prevents it from being used to log in, but does not delete it from the account list. This option can only be modified by an Administrator level account.
3. Click the add icon to add a user specific SSH Public Key
 - a. Enter **Label** and **SSH Public Key** information
 - b. Click **Save** button when finished.

Figure 3-30 Add Icon

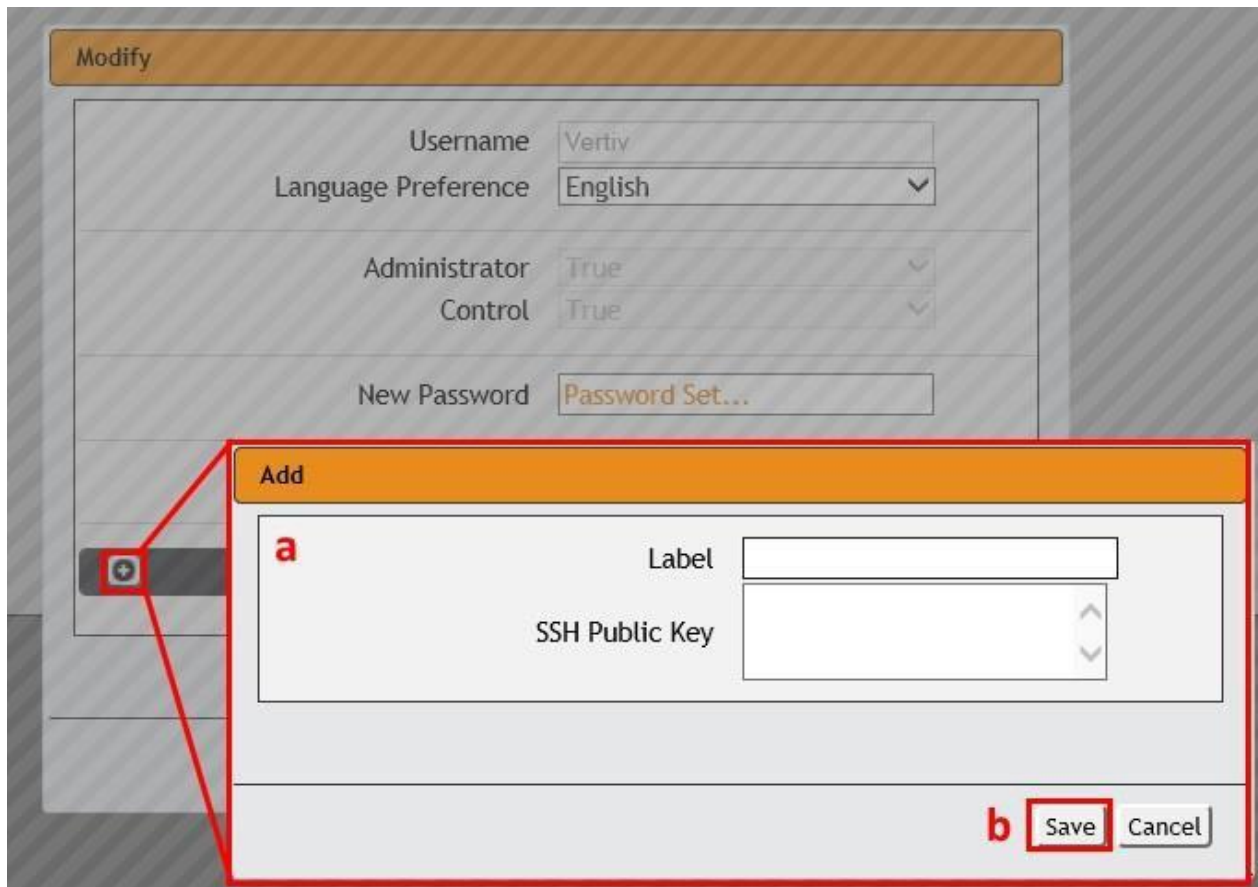

4. Click the **Save** button when finished.

5.5.2. NETWORK

The Unit's network configuration is set on the network tab of the System Menu. Settings pertaining to the unit's network connection are:

Figure 3-31 Network Configuration Page

Hostname

Hostname

Interfaces

Label	MAC Address	DHCP	Link state	Uptime
Bridge 0	00:19:85:00:ad:36	Disabled	Up	1907170

IP Address	Prefix
192.168.123.123	24
10.0.250.62	24
fe80::219:85ff:fe00:ad36	64

Ports

Label	Interface	RSTP Role	STP State	Link state	Uptime	Enabled
Port 0	Bridge 0	Unknown	Forwarding	Up	1907170	Enabled
Port 1	Bridge 0	Unknown	Disabled	Down	1977658	Enabled

Routes

Destination	Prefix	Gateway	Interface
default	0	10.0.250.1	all

DNS

DNS Server Address
8.8.8.8
8.8.4.4

RSTP

Enable

Mode

Max Hops

Hello Time

Max Age

Forward Delay

- **Hostname:** The Hostname may be used as a method for device identification on the network.
- **Interfaces:** This section is used to configure the IP address of the PDU, enable/disable DHCP and to view Link State and Uptime. The device will support up to 8 user configured IP address entries.
- **Ports:** Used to view and/or modify Ethernet port settings and RSTP status of each port on PDU.
- **Routes:** Displays configured routes and is where you will set your Gateway address for the PDU. Default routes are distinguished by a "destination" of "0.0.0.0" or "::", with a Prefix of "0" and Interface of "all". Only one default route can exist for IPv4 and one for IPv6.
- **DNS:** Allows the unit to resolve host names for email, NTP, and SNMP servers.
- **RSTP:** This section is used to Enable/Disable RSTP and/or modify RSTP settings

Figure 3-32 Editing Interfaces Parameters

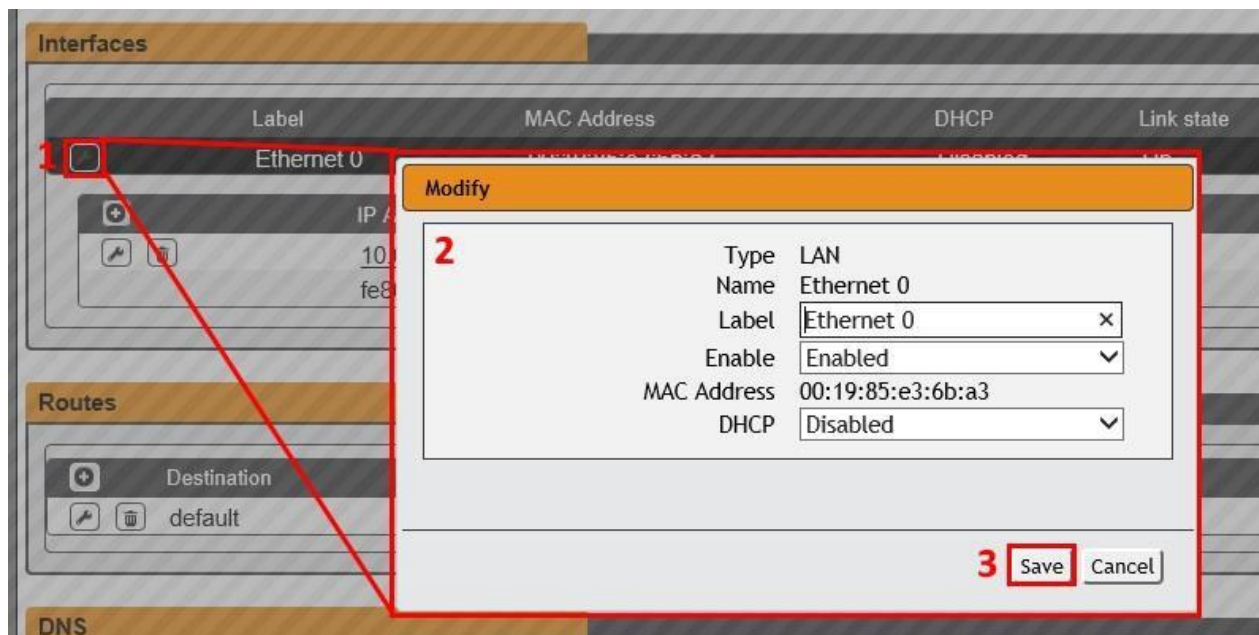

To edit the **Interfaces** parameters:

1. Click the **Modify** icon
2. Modify desired fields which include:
 - a. **Label** - Change the desired name of the selected interface.
 - b. **Enable** - Enable/Disable the selected interface. Please note that if only one interface is available/configured, disabling the interface will restrict access to the device requiring a network reset.
 - c. **DHCP** - Enable/Disable DHCP on the selected interface. DHCP is enabled by default and will be disabled if a static IP address is configured.
3. Click the **Save** button



NOTE

Any changes you make to the Network Interface settings will take effect once the Save button is clicked! If you have changed the IP address it will appear as if the unit is no longer responding because the browser will not be able to reload the web page. Just stop or close the browser window, then type the new IP address into the browser's address bar, and the unit will be accessible.

Figure 3-33 Add New IP Address

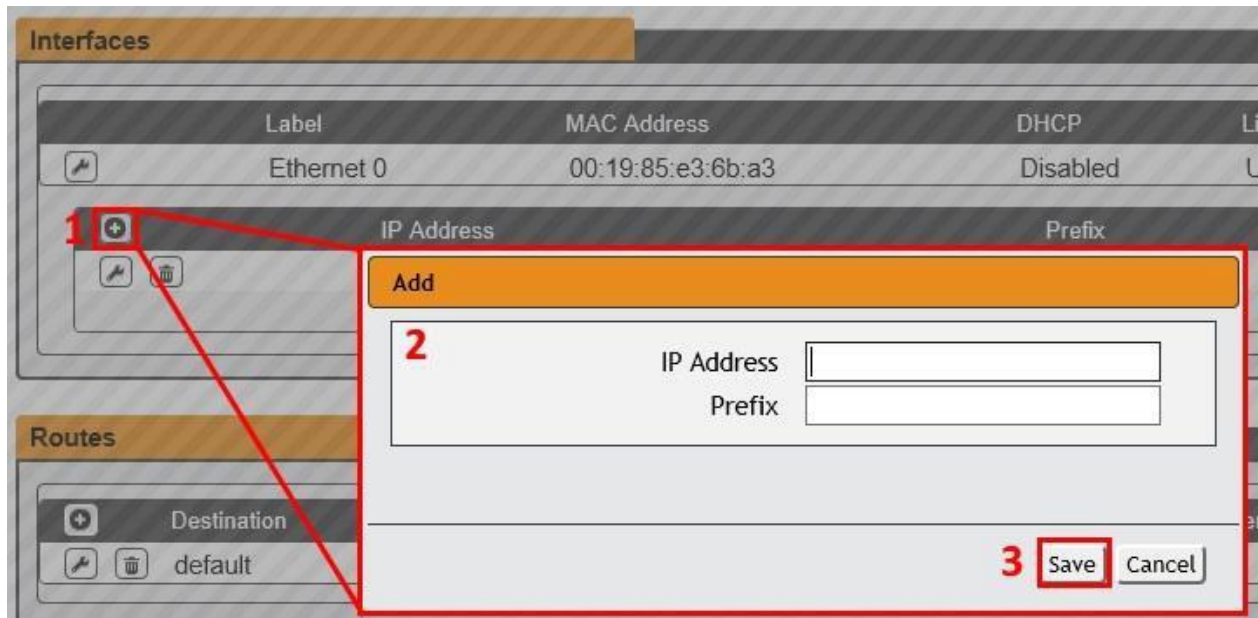

To add a new IP Address:

1. Click the **Add** icon.
2. Enter the IPv4 or IPv6 Address and Prefix/Subnet Mask into appropriate fields. Up to 8 IP addresses can be statically assigned.
3. Click the **Save** button.

Figure 3-34 Modify Existing IP Address

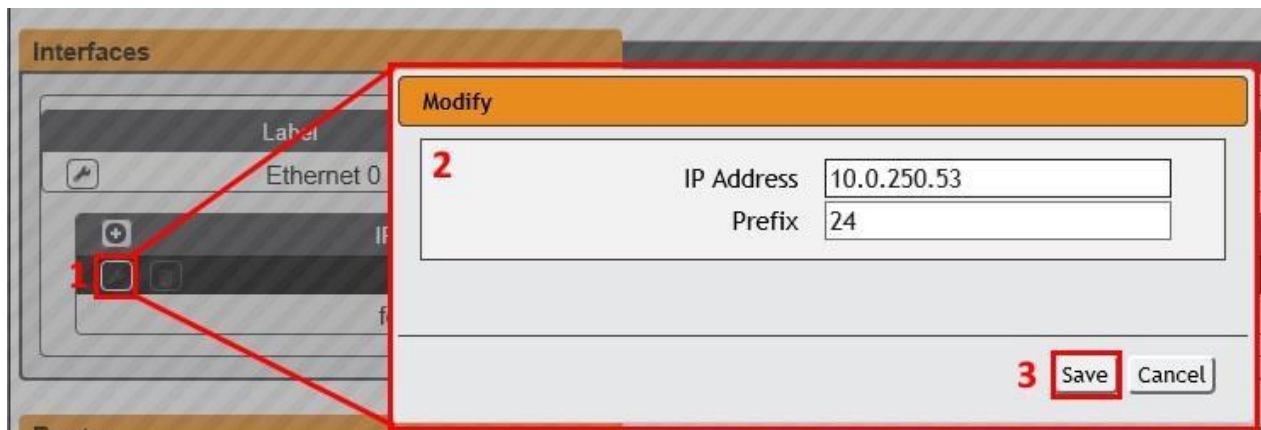

To modify an existing IP Address:

1. Click the **Modify** icon.
2. Edit the IP Address and Prefix/Subnet Mask fields as needed.
3. Click the **Save** button.

Figure 3-35 Modify Port Settings

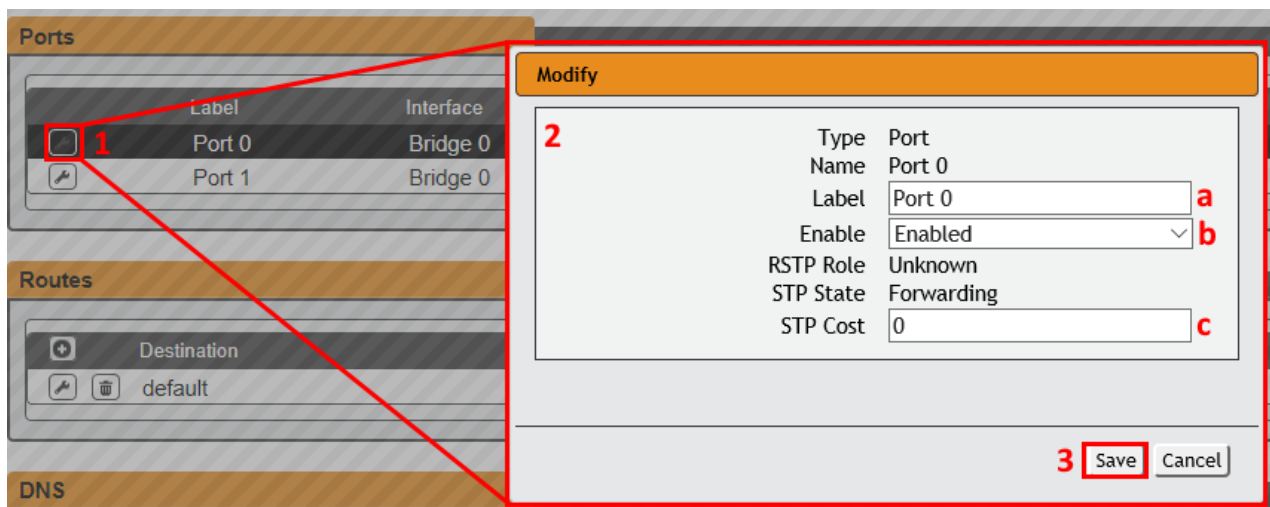

To add a new Route:

1. Click the **Modify** icon.
2. Enter the appropriate information
 - a. Change port label if desired
 - b. Enable/Disable port
 - c. Assign STP cost. This designates this interface's contribution to the root path cost, when it serves as the root port.
3. Click the **Save** button.

Figure 3-36 Add a New Route

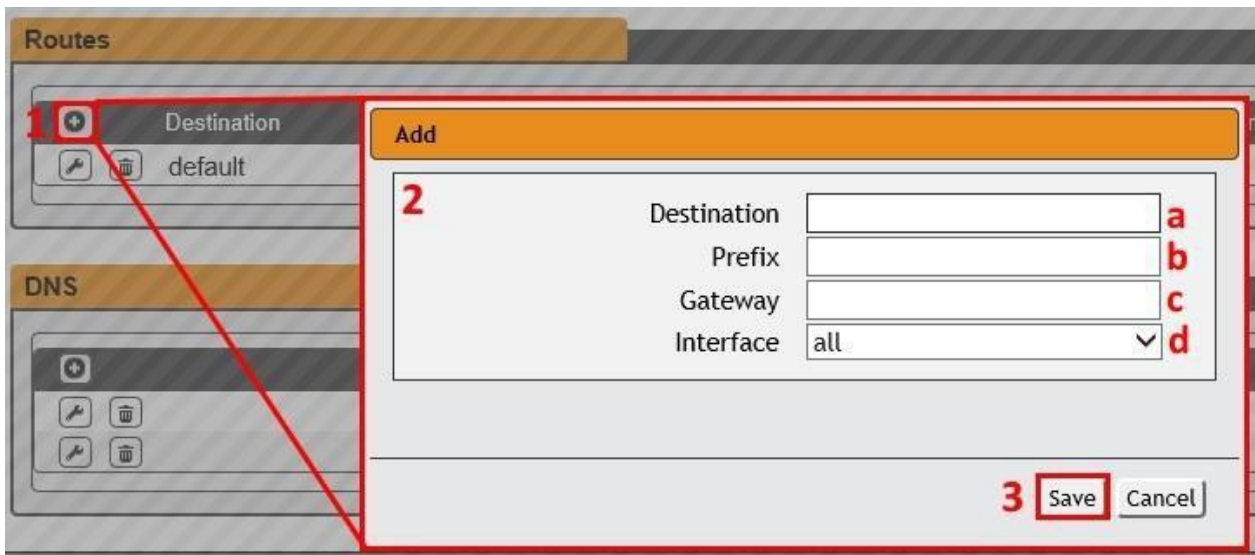

To add a new Route:

1. Click the **Add** icon.
2. Enter the appropriate information
 - a. Destination IP address for desired route
 - b. Enter Prefix for desired route
 - c. Enter Gateway IP address
 - d. Select Interface that route applies to
3. Click the **Save** button.

Figure 3-37 Modify an Existing Route

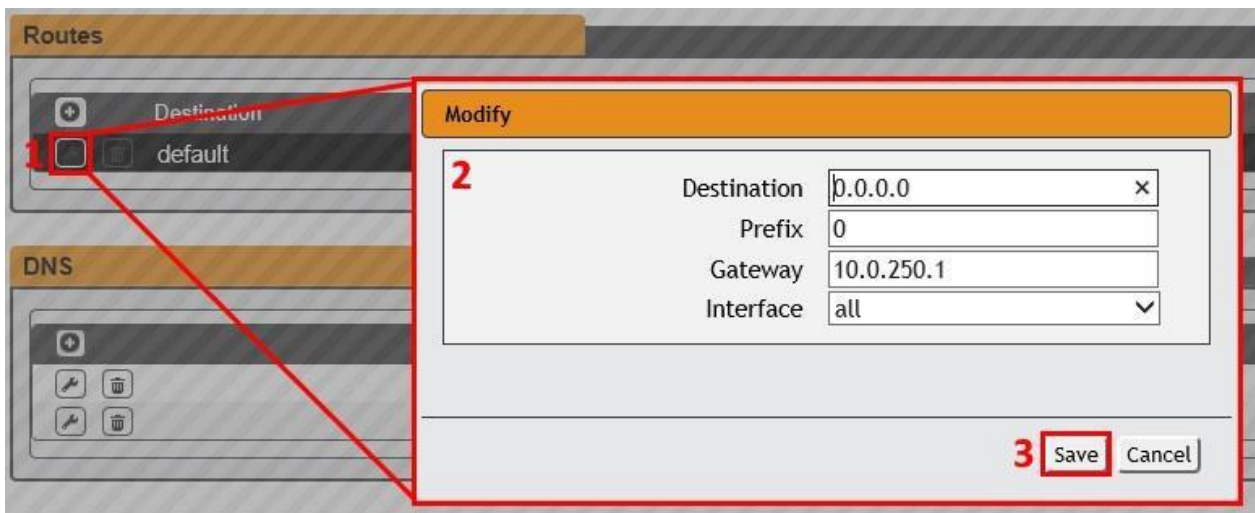

To modify an existing Route:

1. Click the **Modify** icon
2. Edit the desired fields
3. Click the **Save** button

Figure 3-38 Add a New DNS Server Address

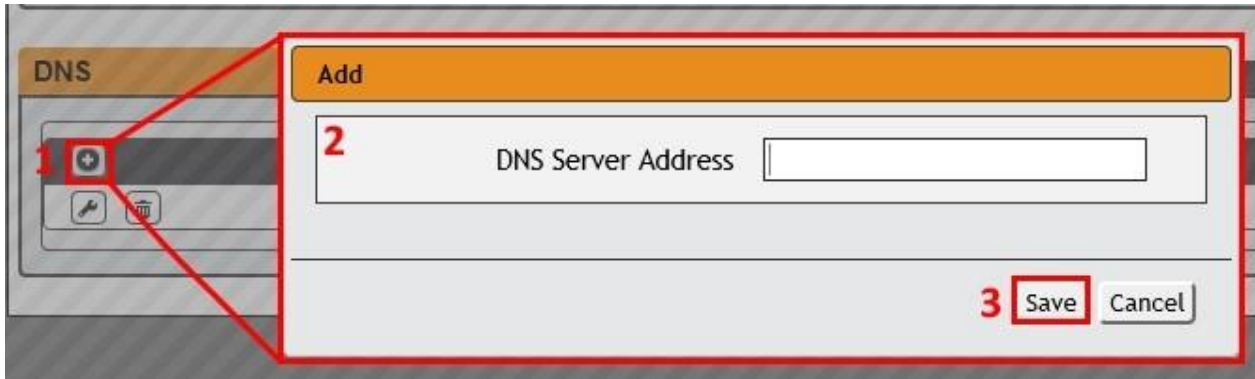

To add a new DNS Server Address:

1. Click the **Add** icon.
2. Enter the IP of the desired DNS server. Up to two DNS servers can be added.
3. Click the **Save** button.

Figure 3-39 Modify an Existing DNS Server IP Address

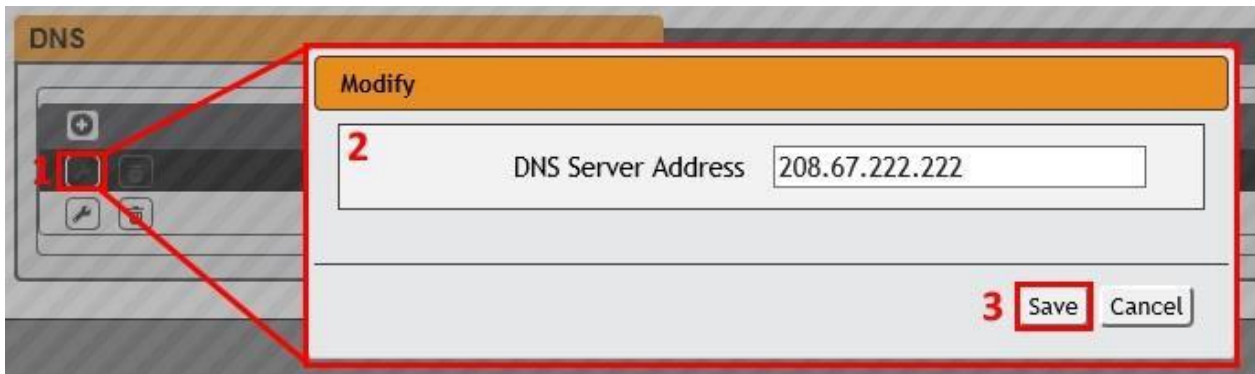

To modify an existing DNS Server Address:

1. Click the **Modify** icon
2. Edit the DNS Server Address field as required
3. Click the **Save** button

Figure 3-40 RSTP Information

Use the RSTP section to Enable/Disable the RSTP Protocol, as well as make changes to RSTP settings.

Enable: Enable or Disable RSTP protocol

Mode: mode can be either "stp" or "rstp". RSTP mode supports falling back to STP when necessary.

Max Hops: The maximum number of bridge traversals of the information transmitted by this interface, when it serves as the root bridge. Used when "mode" is set to "rstp".

Hello Time: The interval, in seconds, between periodic transmissions of configuration messages by designated ports.

Max Age: The maximum age, in seconds, of the information transmitted by this interface, when it serves as the root bridge. Used when "mode" is set to "stp". Should be at least $2 * (\text{helloTime} + 1 \text{ second})$.

Forward Delay: The delay, in seconds, used by bridges to transition the root bridge and designated ports into forwarding mode. Should be at least $(\text{maxAge} / 2) + 1 \text{ second}$.

Click **Save** button after desired changes are made.

5.5.3. WEB SERVER

The unit's Web Server configuration page can be used to update Web Server information and upload self-signed SSL certificates.

Figure 3-41 Web Server Configuration Page

- **HTTP Interface:** Enables/disables access via HTTP. HTTPS interface will always be enabled. Available options are: Enabled or Disabled. It is not possible to disable the web interface completely.

- **HTTP/HTTPS Server Port:** Allows you to change the TCP ports which the HTTP and HTTPS services listen to for incoming connections. The defaults are port 80 for HTTP and 443 for HTTPS.

Figure 3-42 SSL Certificate Configuration Page



SSL Certificate

SSL Certificate File Browse...

Password

Submit

- **SSL Certificate:** Allows you to upload your own signed SSL Certificate file to replace the default one. The certificate can be either self-signed or signed from a Certification Authority. Certificate must meet the following parameters:

Certificate must be in either PEM or PFX (PKCS12) format

- **PEM Format**

1. The public certificate and private key must reside in the same file
2. The certificate must follow standard x.509
3. The private key must be generated with the RSA algorithm and in PEM format
4. The PEM RSA private key may be password secured.

- **PFX Format**

Support is also available for the PKCS12 standard (.pfx) which is a binary encrypted combination of a PEM public certificate and its PEM private key. When generating a PFX certificate you will be prompted for an optional password.

5.5.4. REPORTS



The **Reports** page allows the user to schedule the device to send recurring status reports.



NOTE

SMTP email must be set-up on the device via the Email page.

Figure 3-43 Reports Page

Reports				
	Days	Start Time	Interval (hours)	Targets
 	M-W-F--	00:00	12	[1]

To Add or Modify a scheduled report:

1. Click the **Add** or **Modify** icon.

Figure 3-44 Add or Modify Report Schedule

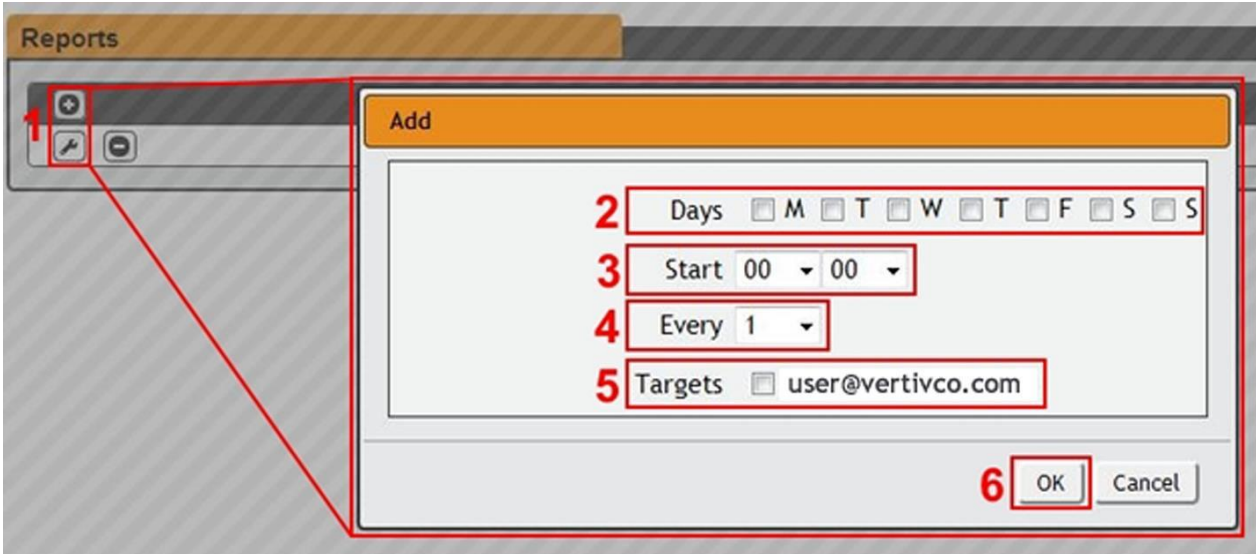

2. Select the **Days** the report is to be sent.
3. Select the time of the day to **Start** sending reports.
4. Set the interval (in hours).

5. Select the **Target** email address for the reports to be sent.
6. Click **OK** to save changes.

To Delete a scheduled Report:

1. Click on the **Delete** icon next to the report to delete.
2. Click the **OK** button on the pop-up window to confirm.

5.5.5. LDAP

The Lightweight Directory Access Protocol (LDAP) can be setup through this menu.

Figure 3-45 LDAP Menu

Enable	Enabled
LDAP Server Address	host
LDAP Server Port	389
LDAP Mode	Active Directory
Security Type	None
Bind DN	
Bind Password	No Password...
Base DN	
User Filter	(objectClass=posixAccount)
"uid" Mapping	uid
"uidNumber" Mapping	uidNumber
Group Filter	(objectClass=posixGroup)
"gid" Mapping	gidNumber
"memberUid" Mapping	memberOf
Enabled Group	enabled
Control Group	control
Admin Group	admin

Save

- **Enable:** Enabling or Disabling LDAP.
- **LDAP Server Address:** Specify the host address for LDAP. The "HOST" can be an IPv4 address, an IPv6 address in brackets (ie. [2001:0DB8:AC10:FE01::]), or a host name.
- **LDAP Server Port:** Used to set the LDAP port number. The default port for LDAP is 389.
- **LDAP Mode:** Available LDAP modes are Active Directory or OpenLDAP.

- **Bind Password:** Password used to bind to the directory server.
- **Base DN:** DN to use for the search base.

The remaining fields come from the NIS schema, defined in RFC2307. They are used to authenticate users in LDAP. Leaving them blank will use the default value as shown in the picture above.

- **User Filter:** LDAP filter for selecting users.
- **"uid" Mapping:** Name of the server attribute that corresponds to the "uid" attribute in the schema.
- **"uidNumber" Mapping:** Name of the server attribute that corresponds to the "uidNumber" attribute in the schema.
- **Group Filter:** LDAP filter for selecting groups.
- **"gid" Mapping:** Name of the server attribute that corresponds to the "gid" attribute in the schema.
- **"memberUid" Mapping:** Name of the server attribute that corresponds to the "memberUid" attribute in the schema.
- **Enabled Group:** Users in this group will have access to unit and permissions based on **Control Group** and **Admin Group** settings.
- **Control Group:** Users in this group have "control" privileges as described in the **Users** section of this manual.
- **Admin Group:** Users in this group have "admin" privileges as described in the **Users** section of this manual. LDAP users do not count toward minimum number of required admin users.

5.5.6. DISPLAY

The unit's local display settings can be changed via the Display tab of the System menu.

Figure 3-46 Display Mode

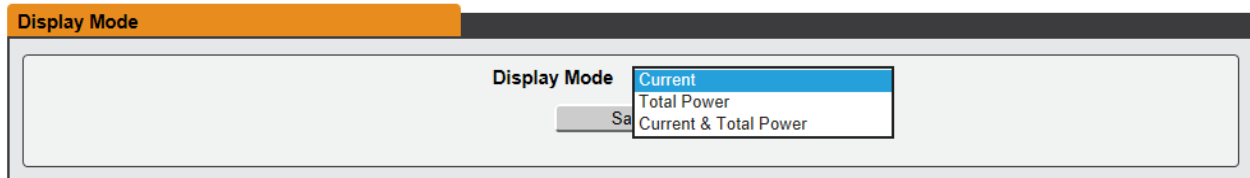

The **Display Mode** section allows the user to configure what measurements are scrolling on the local display.

1. **Current** mode will scroll all current measurements in Amps for Total, Phases and Circuits on the local display.
2. **Total Power** mode will display the Total Power in kilo-watts on the local display.
 - a. <10kW will be displayed as n.nn
 - b. ≥10kW will be displayed as nn.n
3. **Current & Total Power** mode will display both Current in Amps and Total Power as indicated above.
4. Click the **Save** button after making **Display Mode** selection.

Figure 3-47 VLC Mode

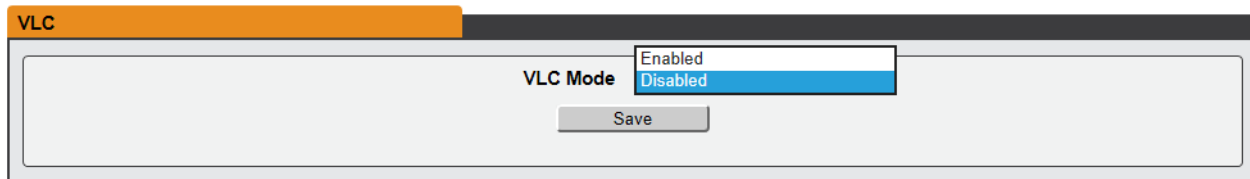

The **VLC Mode** section allows the user to configure what measurements are scrolling on the local display.

1. Select **Enable** to turn on VLC mode. Refer to the Interchangeable Monitoring Device section for more information on VLC.
2. Select **Disable** to turn off VLC mode and return to the currently configured **Display Mode**.

NOTE: VLC can also be Enabled/Disabled by using a button press sequence on the local display. VLC Mode cannot be permanently disabled.

5.5.7. TIME

The unit's time and date are set on this page.

Figure 3-48 Time Configuration Page

Time

Mode NTP

Date-Time (YYYY-MM-DD hh:mm:ss) 2014-09-17 08:50:20

Time Zone America/Chicago

Primary NTP Server 0.pool.ntp.org

Alternate NTP Server 1.pool.ntp.org

Save

There are two mode available: **Network Time Protocol (NTP)** and **Manual**.

1. NTP synchronizes the unit's time and date to the specified time zone using listed NTP Servers. NTP servers can be reconfigured.
2. In Manual mode, the date and time must be typed as indicated on the left of the field.

5.5.8. SSH

The SSH menu allows you to configure settings for SSH access to the device.

Figure 3-49 SSH Configuration Page

SSH

SSH Access Enabled

Port 22

Save

- **SSH Access:** Enables/disables access via SSH.
- **SSH Port:** Allows you to change the port which the SSH service listen to for incoming connections. The default is port 22.

5.5.9. EMAIL

The unit is capable of sending email notifications to up to ten email addresses when an Alarm or Warning Event occurs.

Figure 3-50 Email Configuration Page



Target email addresses can be configured as follows:

Figure 3-51 Email Target Address Page



Legend of icons/buttons:

1. Add new target email address.
2. Modify existing target email address.
3. Delete existing target email address.
4. Send test email.

To send emails, the unit must be configured to access the mail server, as follows:

- **SMTP Server:** The name or IP address of a suitable SMTP or ESMTP server.

- **Port:** The TCP port which the SMTP Server uses to provide mail services. Typical values would be port 25 for an unencrypted connection, or 465 and 587 for a TLS/SSL-encrypted connection, but these may vary depending on the mail server's configuration.
- **Enable SSL:** If Enabled, the unit will attempt to connect to the server using a fully-encrypted TLS/SSL connection. When this setting is enabled only fully-encrypted sessions are supported; the "StartTLS" method, where the session starts out as unencrypted and then switches to encrypted partway through the session, is not supported. If using a service that utilizes StartTLS, such as Office365, please leave this option Disabled.
- **"From" Email Address:** The address which the unit's emails should appear to come from. Many hosted email services, such as Gmail, will require this to be the email account of a valid user.
- **Username and Password:** The login credentials for the email server. If your server does not require authentication (open relay), these can be left blank.

Microsoft Exchange servers will have to be set to allow SMTP relay from the IP address of the unit. In addition, the Exchange server will need to be set to allow "Basic Authentication", so that the unit will be able to log in with the AUTH LOGIN method of sending its login credentials. Other methods, such as AUTH PLAIN, AUTH MD5, etc. are not supported.

Figure 3-52 Email Target Configuration Page

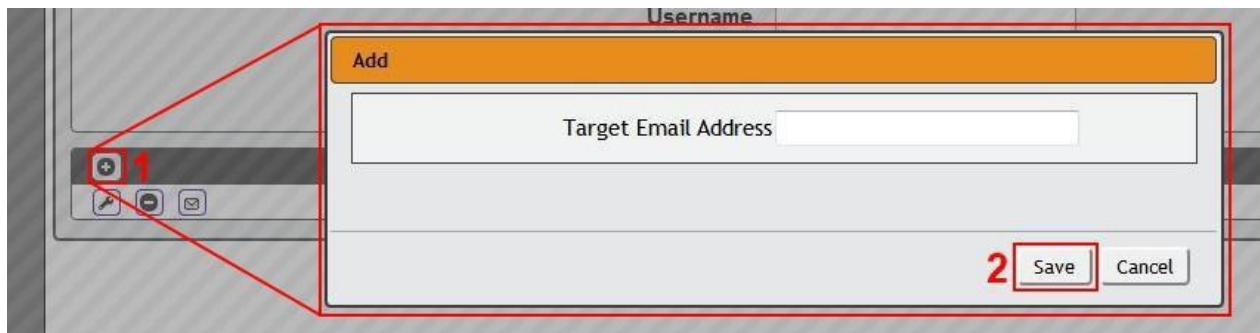

To Add or Modify a Target Email address:

1. Click on the Add or Modify icon.
2. Type email address and then click **Save**.

To Delete a Target Email address:

1. Click on the Delete icon next to the address you wish to delete.
2. Click the **Delete** button on the pop-up window to confirm.

To send a test email:

1. Click on the Test Email icon next to the address you wish to test.
2. A pop-up window will indicate that the test email is being sent. Click **OK** to dismiss the pop-up.

5.5.10. SNMP

Simple Network Management Protocol (SNMP) can be used to monitor the unit's measurements and status, if desired. SNMP v1, v2c and v3 are supported. In addition, alarm traps can be sent to up to two IP addresses.

Figure 3-53 SNMP Configuration Page

The screenshot shows the SNMP configuration interface. At the top, there is a link to "Download the MIB ZIP". Below this, there are two dropdown menus: "SNMP-V1/V2c Service" and "SNMP-V3 Service", both set to "Enabled". A "Port" field is set to "161". A "Save" button is located at the bottom of the configuration area.

The **SNMP-V1/V2c Service** and **SNMP-V3 Service** can be enabled or disabled independently as desired. The service will normally listen for data-read requests (a.k.a. "GET requests") on **Port 161**, which is the usual default for SNMP services; this can also be changed if desired.

The Management Information Base (MIB) can be downloaded from the unit, if needed, via the MIB link at the top of the web page. Clicking this link will download a .ZIP archive containing both the MIB file itself, and a CSV-formatted spreadsheet describing the available OIDs in a human-readable form to assist you in setting up your SNMP manager to read data from the unit.

Figure 3-54 SNMP Users Configuration Page

The screenshot shows the "Users" configuration page with a table listing various SNMP user types and their settings.

Type	Name	Authentication	Privacy
V1/V2c Read Community	public	—	—
V1/V2c Write Community	private	—	—
V1/V2c Trap Community	private	—	—
V3 Read		None	None
V3 Read/Write		None	None
V3 Trap		None	None

The **Users** section allows you to configure the various Read, Write, and Trap communities for SNMP services. You can also configure the authentication types and encryption methods used for the SNMP v3 if desired. Click the Modify icon to change settings.

Figure 3-55 SNMP Traps Configuration Page

The screenshot shows the "Traps" configuration page with a table header for defining trap configurations.

	Host	Port	Version
--	------	------	---------

Traps allow you to define the trap destination IP address, the trap port number and the type of SNMP trap to be used.

Figure 3-56 SNMP Traps/Types IP Configuration Page



To configure a trap destination:

1. Locate the **Traps** section of the SNMP page, and click on the Add icon.
2. Enter the IP Address which the trap should be sent to in the **Host** field, change the **Port** number if required, select the trap **Version** to be used (v1, v2c, or v3), and click **Save**.

A test trap may be sent by clicking on the Test icon next to the Host IP address. Trap settings can also be updated/changed by clicking the Modify icon next to the Host IP address.

5.5.11. SYSLOG

Syslog data can be captured remotely but must first be setup and enabled via the Syslog page.



NOTE

This function is primarily only useful for diagnostic purposes, and should normally be left Disabled unless advised to enable it by Vertiv technical support for troubleshooting a specific issue.

Figure 3-57 Syslog Configuration Page

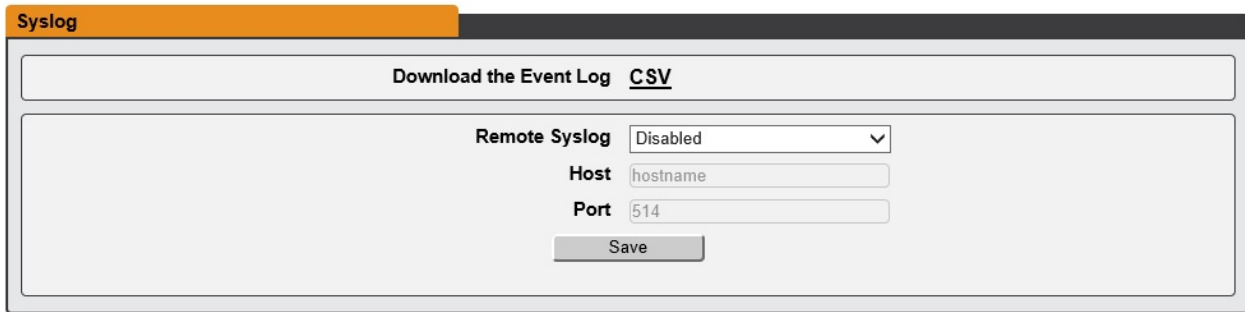

Event log data can be downloaded by clicking on the **CSV** link at that top of the page. The event log will show system events such as user logins, configuration changes, service status, etc. The event log does not contain measurement data captured by the PDU as that data is located in the Data Log which can be found in the Sensors -> Logging page on the GUI.

5.5.12. ADMIN

The Admin page allows the administrator of the device to save their contact information along with the device description and location. Once the info is saved by an administrator, other (non-administrator) users can view the information. Also, the System Label can be modified on this page. This label is typically shown in the title bar of the web browser's window, and/or on the browser tab(s) currently viewing the device.



NOTE

This information is strictly for the users' and administrator's convenience. The unit will not attempt to send emails to the "Administrator Email" address and this address cannot be chosen as the Target of an Event Action when configuring an Alarm or Warning Event.

Figure 3-58 Admin Configuration Page

Admin

Description

Location

Administrator Name

Administrator Email

Administrator Telephone

Save

System Label

Save

5.5.13. LOCALE

The Locale page sets the default Language and Temperature Units for the device. These settings will become the default viewing options for the device, although individual users can change these options for their own accounts. The Guest account will only be able to view the device with the options set here.

Figure 3-59 Locale Configuration Page

Locale

Default Language

Temperature Units

Save

5.5.14. UTILITIES

The Utilities page in the System menu provides the ability to backup/restore configuration, restore defaults, reboot the communication system, perform firmware updates and enable factory access.

Figure 3-60 Configuration backup and Restore Page

Configuration Backup and Restore

Download Configuration Backup File [BIN](#)

Backup File

Restore

The Configuration Backup and Restore section allows the user to backup the PDU configuration file for future use in the case that the device is reset to defaults for any reason.

To download the current configuration click on the **BIN** link and save the file to an easily accessible location such as the local computer or a shared network folder.

To restore a device configuration, click the Browse button and locate the appropriate configuration file and then click the Restore button.

Figure 3-61 Restore Default Page

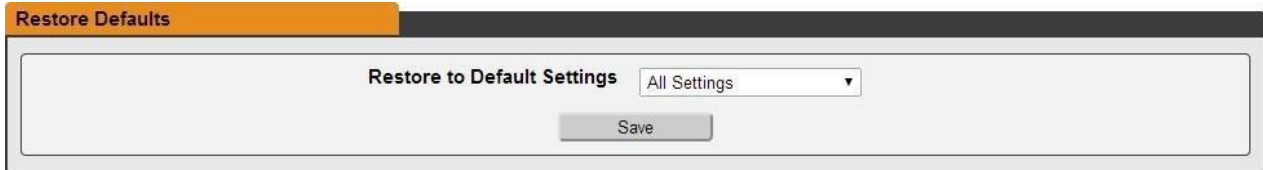

The Restore Defaults section allows the user to restore the unit's settings to the factory defaults. There are two options:

- **All Settings:** erases all of the unit's settings, including all Network and User Accounts settings, effectively reverting the entire unit back to its original out-of-the-box state.
- **All Non-Network Settings:** erases all settings except the Network and User Accounts.

Figure 3-62 Reboot Page



The Reboot section allows the user to perform a system reboot. This function will not affect power delivery to connected equipment.

Figure 3-63 Firmware Update Page

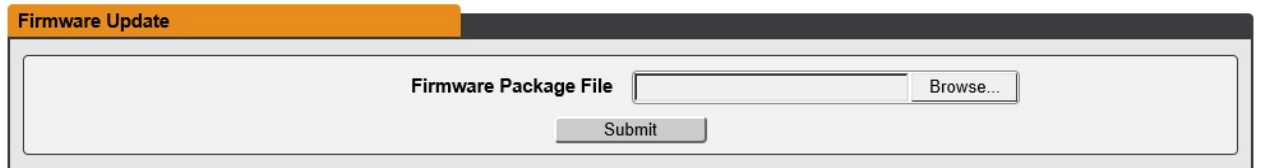

Use the Firmware Update section to load firmware updates into the unit. Firmware updates, when available, can be found on the Vertiv website: <http://www.vertivco.com/Firmware-Support>.

You can also subscribe to a mailing list, to be notified of when firmware updates become available.

Firmware updates will typically come in a .ZIP archive file containing several files including the firmware package itself, a copy of the SNMP MIB, a "readme" text file explaining how to install the firmware, and various other support files as needed. Be sure to un-ZIP the archive and follow the included instructions. Firmware updates will not affect power delivery to connected equipment.

Figure 3-64 Factory Access Page

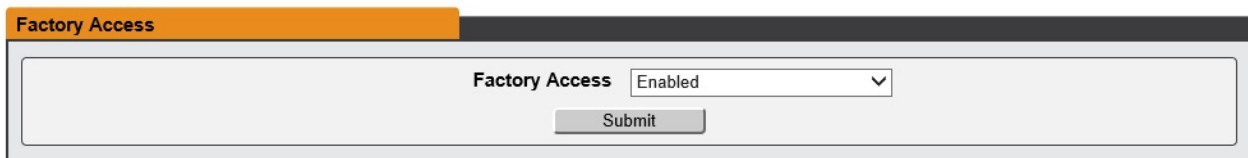

Factory Access

Factory Access Enabled

Submit

- **Factory Access:** Enabling Factory Access mode allows Vertiv support technicians access to more in-depth diagnostic information. It is recommended that this option be set to Disabled unless a Vertiv support member instructs you to enable it.

5.6.HELP

5.6.1. INFO

The Info Page displays the unit's current configuration information, including the device name and ID, the type of IMD installed, the unit's current firmware versions, and network information. Manufacturer support information is also here.

Figure 3-65 Info Page

Info	
Device Name	Vertiv IMD PDU
Serial Number	DEVUNIT6
Model Number	NO PART NUMBER LOADED
Part Number	—
Device Type	I-03
Version	5.2.2
GUI Version	1.4.0
MAC Address	00:19:85:00:ad:36
Hostname	R00198500ad36
Lifetime Energy (kWh)	11.733
Manufacturer	Vertiv
Manufacturer Site	VertivCo.com/geist
Support Site	VertivCo.com/support
Support Email	support@VertivCo.com
Support Telephone	1-800-432-3219

5.6.2. SUPPORT SITE

Technical support can be found at <http://www.vertivco.com/support>

Phone Support

- 1.800.432.3219

5.7. TECHNICAL SUPPORT

5.7.1. RESETTING PDU

Should the PDU lose communication, the following reset/reboot buttons are available to help with troubleshooting:

1. **Network-Reset Button** (○): Located under the Ethernet port, users will need to use a small pin or paper clip to contact this button. Holding the Network-Reset button for 5 seconds during normal operation will restore the default IP address and reset the user accounts.
2. **Hard-Reboot Button** (↻): Pressing the Hard-Reboot button reboots the monitoring device. This acts as a power-cycle for the device, and does not change or remove any user information.



NOTE

This will NOT affect power to the connected devices.

5.7.2. SERVICE AND MAINTENANCE

- No service or maintenance is required.
- There are no serviceable parts inside the PDU.



WARNING

Do not attempt to open the PDU or the warranty will be void.

5.7.3. USING MICROSOFT EXCHANGE AS AN SMTP SERVER

If your facility uses a Microsoft Exchange email server, it can be used by the Vertiv Upgradeable PDU to send Alarm and Warning notification emails if desired. However, the Exchange server may need to be configured to allow SMTP connections from the unit first, as later version of Exchange often have SMTP services or basic authentication disabled by default. If you encounter difficulties in getting your IMD PDU to send emails through your Exchange server, the following notes may be helpful in resolving the problem.

**NOTE**

These suggestions only apply if you are using your own, physical Exchange server! Microsoft's hosted "Office365" service utilizes a Start-TLS connection and can be setup using the standard "Office365" email server settings in the email configuration menu.

First, since the Vertiv Upgradeable PDU cannot use IMAP or Microsoft's proprietary MAPI/RPC Exchange/Outlook protocols to send messages, you will need to enable SMTP by setting up an "SMTP Send Connector" in the Exchange server. More information on setting up an SMTP Send Connector in Exchange can be found at this Microsoft TechNet article: <http://technet.microsoft.com/en-us/library/aa997285.aspx>

Next: Your Exchange server may also need to be configured to allow messages to be "relayed" from the monitoring unit. Typically, this will involve turning on the "**Reroute incoming SMTP mail**" option in the Exchange server's **Routing** properties, then adding the PDU's IP address as a domain which is permitted to relay mail through the Exchange server. More information about enabling and configuring SMTP relaying in Exchange can be found at this Microsoft TechNet article: <http://technet.microsoft.com/en-us/library/dd277329.aspx>

The SMTP "AUTH PLAIN" and "AUTH LOGIN" authentication methods (also known as "Basic Authentication") for logging in to the server are often no longer enabled by default in Exchange; only Microsoft's proprietary NTLM authentication method is enabled. The AUTH LOGIN method which the IMD PDU requires can be re-enabled as follows:

1. In the Exchange console under **server configuration**, select **hub transport**.
2. Right-click the client server, and select **properties**.
3. Select the **authentication** tab.
4. Check the **Basic Authentication** checkbox.
5. Uncheck the **Offer Basic only after TLS** checkbox.
6. Apply or save these changes, and exit. Note that you may need to restart the Exchange service after making these changes.

Finally, once you have enabled SMTP, relaying, and the AUTH LOGIN Basic Authentication method, you may also need to create a user account specifically for the PDU to log into. If you have already created an account prior to enabling the SMTP Send Connector, or you are trying to use an already-existing account created for another user, and the PDU still cannot seem to connect to the Exchange server, the account probably did not properly inherit the new permissions when you enabled them as above. This tends to happen more often on Exchange servers that have been upgraded since the account(s) you are trying to use were first created, but can sometimes happen with accounts when new connectors and plug-ins are added regardless of the Exchange version. Delete the user account, then create a new one for the monitoring unit to use, and the new account should inherit the SMTP authentication and mail-relaying permissions correctly.

If none of the above suggestions succeed in allowing your Vertiv Upgradeable PDU to send mail through your Exchange server, then you may need to contact Microsoft's technical support for further assistance in configuring your Exchange server to allow SMTP emails to be sent from a 3rd-party, non-Windows device through your network.

6. CHAPTER 4 - FINAL CHECKOUT

6.1. PRODUCT-SPECIFIC SAFETY NOTICES

The specific procedural safety precautions relating to this product are stated below.

6.1.1. GENERAL SAFETY

Safety is a serious matter and all precautions should be taken to guarantee a safe work and operational environment. General safety precautions must be observed during all aspects of operation, service, and repair of equipment described in this document. Failure to comply with the safety warnings, procedures and guidelines as presented in this document is in violation of the safety standards of design, manufacture, and intended use of this equipment.

You are responsible for following the safety guidelines and warnings presented in this document for this equipment. Individuals using or maintaining Vertiv product(s) are expected to follow all the noted warnings and safety precautions necessary for safe operation of the equipment in your environment. Vertiv assumes no liability for failure to comply with these requirements.

6.1.2. LIVE CIRCUITS SAFETY



DANGER

HAZARDOUS VOLTAGE, CURRENT, AND ENERGY LEVELS ARE PRESENT IN THIS PRODUCT. POWER SWITCHED CIRCUITS CAN HAVE HAZARDOUS VOLTAGES PRESENT EVEN WHEN THE SWITCH IS IN THE OFF POSITION. DO NOT OPERATE THE PRODUCT WITH ANY COVER PLATE REMOVED. ALWAYS MAKE SURE THAT PRODUCT IS FULLY ENCLOSED PRIOR TO USE.

Operating personnel must:

- Not remove equipment covers. Only Vertiv Authorized Service Personnel or other qualified maintenance personnel may remove equipment covers for internal sub-assembly, or component replacement, or any internal adjustment.
- Not replace any equipment component with power applied to the line cord. Under certain conditions, dangerous voltages may exist even with the input power cable disconnected. Any exceptions for 'Hot-Swap' modules will be specifically noted in this product document.
- Always disconnect input power and discharge circuits before touching any sub-assembly of circuit component.

6.1.3. EQUIPMENT GROUNDING

To minimize shock hazard, the equipment chassis and enclosure must be connected to an electrical earth ground. The input power cable must be either plugged into an industry electrical code compatible receptacle or wired directly into an electrical code compatible interface. The equipment earth ground wire (typically green) must be firmly connected to the facility electrical safety ground. The mating electrical interface to this equipment must comply with International Electromechanical Commission (IEC) standards.

6.1.4. ELECTROSTATIC DISCHARGE

Vertiv strongly recommends that anti-static precautions be taken when installing, removing, or working on and around static sensitivity equipment. Industry approved anti-static devices such as wrist and heel straps, in conjunction with conductive foam pads, should be available and implemented only after verifying that they are in good working condition.

Electronic components such as memory modules, circuit boards, and LED displays, are sensitive to Electro-Static Discharge (ESD). Handling of such components should be done only after proper anti-static workspace conditions have been established. Any static producing packing materials such as plastic, Styrofoam, and some cardboards, should be removed and discarded in a timely manner.

6.1.5. EXPLOSIVE ENVIRONMENT

Do not operate this equipment in the presence of flammable gases or fumes. Operation of any electrical equipment in such an environment constitutes a definite safety hazard.

6.1.6. SERVICING AND ADJUSTMENTS

Do not attempt to service this equipment, there are no field serviceable parts or sub-assemblies. Any adjustments should be made by authorized service personnel only.

6.1.7. REPAIRS AND MODIFICATIONS

Because of the danger of electrocution and/or severe health hazard, do not install substitute parts or perform any unauthorized modifications of this equipment. It is best to contact Vertiv for Warranty and Repair Service to ensure that safety features are maintained.



**Thank You For
Purchasing Your Vertiv
Product**

VertivCo.com/geist