



Liebert® ITA2 30 kVA UPS

User Manual

The information contained in this document is subject to change without notice and may not be suitable for all applications. While every precaution has been taken to ensure the accuracy and completeness of this document, Vertiv assumes no responsibility and disclaims all liability for damages result from use of this information or for any errors or omissions.

Refer to local regulations and building codes relating to the application, installation, and operation of this product. The consulting engineer, installer, and/or end user is responsible for compliance with all applicable laws and regulations relation to the application, installation, and operation of this product.

The products covered by this instruction manual are manufactured and/or sold by Vertiv. This document is the property of Vertiv and contains confidential and proprietary information owned by Vertiv. Any copying, use, or disclosure of it without the written permission of Vertiv is strictly prohibited.

Names of companies and products are trademarks or registered trademarks of the respective companies. Any questions regarding usage of trademark names should be directed to the original manufacturer.

Technical Support Site

If you encounter any installation or operational issues with your product, check the pertinent section of this manual to see if the issue can be resolved by following outlined procedures.

Visit <https://www.vertiv.com/en-us/support/> for additional assistance.

TABLE OF CONTENTS

1 Important Safety Information	1
2 Product Introduction	5
2.1 Features	5
2.2 Model Configurations	6
2.3 Appearance and Components	6
2.3.1 Appearance	6
2.3.2 Components	7
2.4 Operating Principle	9
2.5 UPS State and Operation Mode	9
2.5.1 Normal Mode	10
2.5.2 Bypass Mode	11
2.5.3 Battery Mode	12
2.5.4 ECO Mode (for Single UPS with External Battery Only)	12
2.5.5 Fault State	13
2.5.6 Maintenance Bypass Mode	13
2.6 Specifications	14
3 Single UPS Installation and Commissioning	17
3.1 Unpacking Instructions	17
3.2 UPS Movement	18
3.3 Installation Preparation	19
3.3.1 Location	19
3.3.2 Environmental Requirement	19
3.3.3 Installation Tools	21
3.4 External Protective Devices	22
3.4.1 Rectifier and Bypass Input	22
3.4.2 Battery Input	22
3.4.3 UPS Output	22
3.5 Mechanical Installation	23
3.5.1 Tower Installation	23
3.5.2 Rack Installation	25
3.6 Connecting Power Cables	30
3.6.1 Connecting Input/Output Cables	32
3.6.2 Connecting Battery Cables	34
3.7 Single UPS Commissioning	40
3.7.1 Check Before Startup	40
3.7.2 Startup Interface	41
3.7.3 Normal Mode Startup	41
3.7.4 Battery Mode Startup	43

4 Parallel UPS Installation and Commissioning	45
4.1 Features	45
4.2 Requirements	45
4.3 Mechanical Installation	46
4.4 Connecting Power Cables	47
4.4.1 Connecting I/O Cables	47
4.4.2 Connecting Parallel Cables	49
4.4.3 Connecting Battery Cables	49
4.5 Commissioning Parallel System	52
4.5.1 Check Before Startup	52
4.5.2 Parallel System Parameters Setting	53
4.5.3 Power on Commissioning for Parallel System	53
4.6 Installation and Commissioning for Dual Bus System	55
4.6.1 Introduction	55
4.6.2 Installing External Protective Device	55
4.6.3 Connecting Power Cables	55
4.6.4 Connecting LBS Cables	56
4.6.5 Setting Parameters of LBS	57
5 Operation and Display Panel	59
5.1 Introduction	59
5.1.1 LED Indicators	60
5.1.2 Audible Alarm (Buzzer)	60
5.1.3 LCD and Functional Keys	61
5.1.4 Initial Startup Guidance	62
5.2 LCD Menu Structure	66
5.3 LCD Screen Types	66
5.3.1 Start Screen	66
5.3.2 Flow Screen	67
5.3.3 Main Menu Screen	68
5.3.4 Submenu Screen	68
5.3.5 Default Screen	74
5.4 Prompt Window	75
5.5 UPS Alarm Message List	76
6 UPS Operation Instructions	81
6.1 UPS Startup	81
6.2 Transfer Procedures between Operation Modes	81
6.2.1 Transfer from Normal Mode to Battery Mode	81
6.2.2 Transfer from Inverter Mode to Bypass Mode	82
6.2.3 Transfer from Bypass Mode to Inverter Mode	84
6.2.4 Transfer from Inverter Mode to Maintenance Bypass Mode	86

6.2.5 Transfer from Maintenance Bypass Mode to Inverter Mode	88
6.2.6 Adding a Single Unit in Parallel System	88
6.3 UPS Complete Shutdown	88
6.4 REPO	89
6.5 Auto Restart	89
6.6 Language Selection	90
6.7 Changing Current Date and Time	92
6.8 Setting Password	94
7 Communication	99
7.1 Installing Intelligent Card	99
7.1.1 Intelligent Card Port	99
7.1.2 Intelligent Card Option	100
7.2 Connection Cables for Dry Contact Port	101
7.3 Connecting USB Communication Cables	102
7.4 Connecting Serial Port Communication Cable	103
7.5 Connecting Control Port	103
7.6 Connecting Built-in Ethernet Port	103
8 Maintenance	105
8.1 Fan Maintenance	105
8.2 Battery Maintenance	105
8.3 Cleaning UPS	106
8.4 Checking the UPS Operating Status	106
8.5 Checking UPS Functions	106
9 Options	107
9.1 Options	107
9.2 POD	107
9.3 Communication Cables	110
9.4 Guide Rail	110
9.5 Dual Bus Parts	110
9.6 Communication Options and Temperature and Humidity Sensor	111
9.7 Battery Module	112
9.7.1 List of Battery Module Options	112
9.7.2 Appearance of VRLA Battery Module	113
9.7.3 Appearance of Lithium-ion Battery Module	114
9.7.4 Backup Time of Single UPS Standard Battery Module	116
Appendices	117
Appendix A: LCD Parameters Setting	117
Appendix B: Glossary	120
Appendix C: Hazardous Substances and Content	121
Appendix D: Dimension	122

This page intentionally left blank

1 Important Safety Information

Personnel Safety

1. This product must be installed and commissioned by professional engineers of the manufacturer or its authorized agent. Failure to observe this could result in product malfunction or personnel safety risk.
2. Take the time to read this product manual and the safety precaution thoroughly before installing and commissioning this product. Failure to observe this could result in product malfunction or personnel safety risk.
3. This product is not intended for life support equipment applications.
4. Never dispose of the battery of this product in a fire, as it may explode and jeopardize personnel safety when exposed to flame.

Product Safety

1. If this product will be stored or remains de-energized for a long period, it must be placed in a dry and clean environment within specified temperature range.
2. This product should be used in an appropriate operating environment. For details, refer to the section on the environmental requirement in this manual.
3. This product is not designed for application in an environment:
 - Where the temperature and relative humidity are outside the specifications
 - Subject to vibrations or shocks
 - Where conductive dust, corrosive gases, salts, or flammable gases are present
 - Near heat sources or strong electromagnetic interferences

NOTE: Always observe the following safety symbols!



WARNING! Risk of electric shock. Can cause equipment damage, injury, or death. Observe all cautions and warnings in this manual. Failure to do so may result in serious injury or death. Refer all UPS and battery service to properly trained and qualified service personnel. Do not attempt to service this product yourself. Opening or removing the cover may expose you to lethal voltages within this unit even when it is apparently not operating, and the input wiring is disconnected from the electrical source. Never work alone.



CAUTION: Risk of electric shock. Can cause equipment damage, injury, or death.

IMPORTANT! Used to advise the user to carefully read and observe this unit though it may not cause damage. This manual contains the information concerning the installation and operation of Vertiv™ Liebert® ITA2 30 kVA UPS (hereinafter referred to as UPS). Read this manual carefully prior to installation. To reduce the chance of accident, read the safety precautions very carefully before operation. The 'Caution, Note, Warning' in this user manual and on the product do not represent all the safety points to be observed, and are only supplement to various safety points. Therefore, the installation and operation personnel must receive strict training and master the correct operations and all the safety points before operation. When operating Vertiv products, the operation personnel must observe the safety rules in the industry, the general safety points, and special safety instructions provided by Vertiv.



WARNING! The UPS must be installed, commissioned and serviced by engineers designated by Vertiv or by Vertiv representative. Failure to observe this could result in personnel safety risk, UPS malfunction and invalidation of warranty. The UPS has been designed for commercial and industrial use only. Additional measures to control/reduce the radio interference must be taken for residential use as this is a Class C2 UPS product.



WARNING! Backfeed Protection: Before operating the circuit, isolate the UPS first and then check the dangerous voltage between the ports, and earth.



WARNING! When the UPS is operating, do not touch directly or through any wet object to avoid risk of shock due to high voltage.

Conformity and Standards

The UPS complies with 2014/35/EU (LVD), 2014/30/EU (EMC), 2011/65/EU (RoHS) and the following product standards for UPS:

- IEC/EN 62040-1/AS 62040-1: General and safety requirements for UPS
- IEC/EN 62040-2/AS 62040-2: Class C2 compliant
- IEC/EN 62040-3/AS 62040-3 (VFI SS 111): Performance requirements and test methods

The UPS installation should follow the above instructions and use the accessories specified by manufacturer.

Notes to the CE and UKCA Declarations of Conformity

This product conforms to the following European directives and UK Regulations:

2014/35/EU

Directive of the council for adapting the legal regulations of member states on electrical equipment for use within specific voltage limits.

Electrical Equipment (Safety) Regulations: 2016

Regulations implemented according to EU Directive (2014/35/EU) on electrical equipment designed for use within specific voltage limits approved on the GB market.

2014/30/EU

Directive of the council for adapting the legal regulations of member states on electromagnetic compatibility.

Electromagnetic Compatibility Regulations: 2016

Regulations concerning the aspects of electromagnetic compatibility approved on the GB market.

Conformity is established through compliance with the following standards:

- IEC/EN/BS 62040-1:2008+A1:2013
- IEC/EN/BS 62040-2:2018

Additional information regarding adherence to these directives and regulations is included in the appendices NSR and EMC to the Declarations of Conformity. If needed, the Declarations of Conformity can be requested by Vertiv.

2011/65/EU

Directive of the council for adapting the legal regulations of member states on the restriction of the use of certain hazardous substances that can be used in the manufacture of electrical and electronic equipment.

The Restriction of the Use of Certain Hazardous Substances in Electrical and Electronic Equipment Regulations 2012.

The restriction of the use of certain hazardous substances that can be used in the manufacture of electrical and electronic equipment approved on the GB market.



CAUTION: When the UPS is operating, some parts have high voltage, therefore, contacting them directly or through moist objects will result in fatal risk.



WARNING! Before moving or rewiring the UPS, disconnect mains input power and the battery and make sure that the UPS is completely shut down to avoid electric shock due to high voltage. Liquid or other irrelevant external objects are prohibited inside the UPS. In case of a fire, use a dry chemical fire extinguisher or heptafluoropropane gas fire extinguishing system. Do not use a foam fire extinguisher to extinguish the fire, it will cause electric shock. The output neutral line of the UPS is from the input, after the neutral line is suspended by the upstream protection devices, the output neutral line will be unconnected. To prevent the radio frequency of output cables from disturbing other electric equipment, it is recommended to use the UPS output cable with the length less than 10 m. When used in light industrial environment, it is recommended to add nickel-zinc magnetic ring to the output cable and battery cable to reduce electromagnetic emission.



WARNING! High leakage current. Grounding is essential before connecting the input power (AC mains and battery included). Earth leakage current (ranges from 3.5 mA to 100 mA). Transient and steady-state earth leakage currents, which may occur when starting the equipment, should be considered when selecting instantaneous residual current circuit breaker (RCCB) or residual current detector (RCD). Note that the earth leakage current of the UPS will be carried by RCCB or RCD. This equipment must be earthed in accordance with the local electrical codes.



WARNING! When selecting the UPS system upstream distribution protection equipment, ensure that it complies with the local electric regulations. The specified upstream breakers are required to obtain the conditional short-circuit current rating, I_{cc} at 10 kA symmetrical RMS. The specified upstream breakers should comply with an IEC 60947 series standard.



WARNING! Battery high voltage. All the physical service and maintenance of the battery are performed by the trained technicians.

Operation on the battery will result in electric shock and high short-circuit current, therefore, before operating the battery, the following should be observed:

1. Remove the watches, rings and other metal objects.
2. Use the tools with insulation handle.
3. Wear/use proper PPE (rubber gloves and shoes).
4. Avoid placing the tools and metal objects on the battery surface.
5. Disconnect the charge power supply before connecting or disconnecting the battery terminals.
6. Check whether the battery is earthed accidentally, if yes, please disconnect the earthing. Contacting any earth battery parts will result in electric shock. Therefore, make sure that the battery is not earthed during installation and maintenance.
7. Follow battery related precautions provided by the manufacturer the details of the precautions to be observed when working on, or in the vicinity of the batteries. Always follow these precautions implicitly at all times.
8. Pay attention to the recommendations concerning local environmental conditions and the provision of protective clothing, first aid and fire-fighting facilities.

User Serviceable Components

1. The UPS contains no user-serviceable parts. Do not remove the cover. Removing the cover may result in electric shock and will invalidate any implied warranty.
2. All equipment maintenance and servicing procedures involving internal access requires the use of a tool and should be carried out only by trained personnel. There are no user-serviceable parts behind covers requiring a tool for removal.
3. The UPS meets the safety requirements completely in operator access area. Only service personnel can contact with the hazardous voltage inside the UPS. However, the risk of contacting these voltages is minimized because the components with hazardous voltage may be contacted only by using a tool to remove the protective cover. No risk will exist if you follow the general norms and in accordance with the procedures recommended in this manual on equipment operation.

The Manual describes the following devices:

Product	Model
30 kVA	ITA-30k00AL3302P00

2 Product Introduction

The Vertiv™ Liebert® ITA2 30 kVA UPS (UPS for short) is an intelligent online UPS system with sine wave output developed by Vertiv Tech Co., Ltd. The UPS offers reliable and high-quality AC power to the precision instrument.

The UPS can be installed using two methods depending on the end user requirement. The UPS supplies AC power to small scale computer centers, network, communication system, automatic control system and precision instrument.

This chapter introduces the features, model configurations, appearance and components, operating principle, UPS state and operation mode, and specifications of the UPS.

2.1 Features

The UPS features include:

- Output power factor is 1, which enhances the UPS load capacity.
- On-line double conversion efficiency is up to 96.5% and ECO efficiency is up to 99%, that provides more efficient end user experience.
- Decreased product size by 30% as compared to previous generation occupies little space, and makes it easy to handle and assemble simple handling and assembly.
- 3U thickness. Tower installation and rack installation are optional to meet different installation requirements
- Capable of parallel connection to achieve up to 3+1 parallel redundant power.
- High-frequency double conversion topology structure, with high input power factor, wide input voltage range, and output immune to grid interference, makes adaptable to areas with unstable mains supply.
- Full digital control platform and hardware design platform, makes the UPS adaptable to worse unstable mains supply and load impact.
- Support 32, 34, 36, 38, 40 block batteries, the long backup model has a built-in large power charger with 13 A charging capacity to provide fast charging.
- Innovative design of the layout and the whole process greatly promote the reliability of the UPS; pass 1000h high temperature humidity durability experiment test.
- Operation and display panel with colorful LCD show the UPS operation state and operating parameters. The LCD display will change according to the layout of the model.
- Capable of ECO power supply mode and smart sleep mode, which helps to save energy to the maximum extent.

2.2 Model Configurations

The model configurations are shown in **Table 2.1** below.

Table 2.1 Model configurations

Model		Type	Description
30 kVA	Long backup model	ITA-30k00AL3302P00	For single UPS system, 1+1 parallel system and above, the external battery cabinet with large capacity is recommended

Model	Input	Output	Description
30 kVA	Three phase	Three phase	Common input configuration (default), split bypass configuration

2.3 Appearance and Components

2.3.1 Appearance

The general appearance of the UPS is shown in **Figure 2.1** below.

Figure 2.1 Appearance of UPS



2.3.2 Components

Front Panel

As shown in **Figure 2.2** below, the front panel of the UPS has ventilation holes, operation and display panel, LED indicators and functional keys.

Figure 2.2 UPS Front Panel

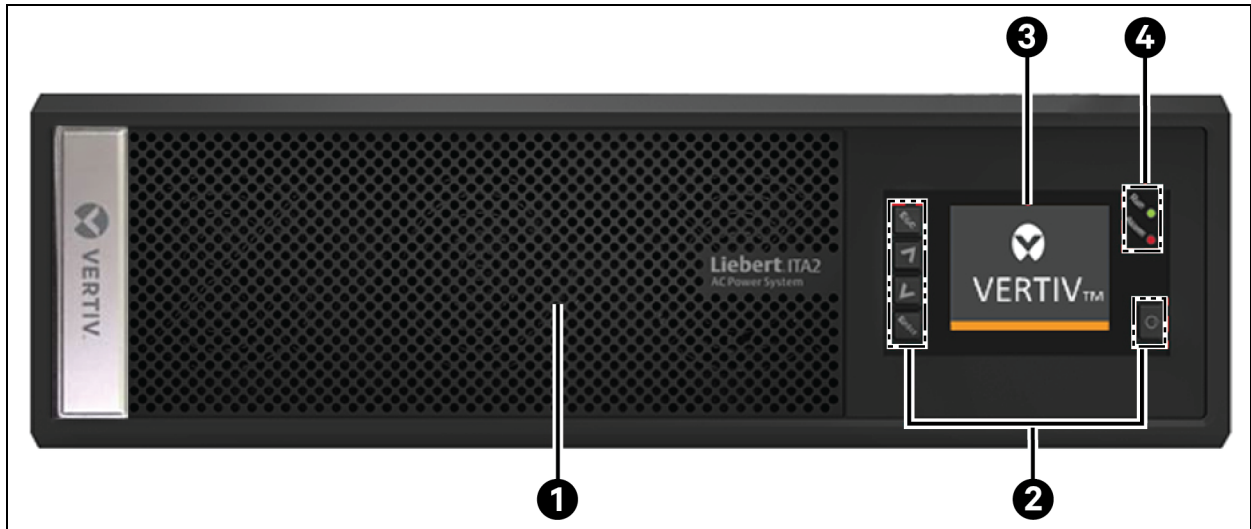

Item	Description
1	Ventilation holes
2	Functional keys
3	Operation and display panel
4	LED indicators

Rear Panel

As shown in **Figure 2.3** below, the rear panel of the UPS has parallel/LBS ports, dry contact port, I/O terminal block, battery terminal block, Intellislot port, Ethernet port, USB port, RS232 port, REPO port and multifunction port. The SIC card in the Intellislot port is optional, purchase it, if required.

Figure 2.3 UPS Rear Panel

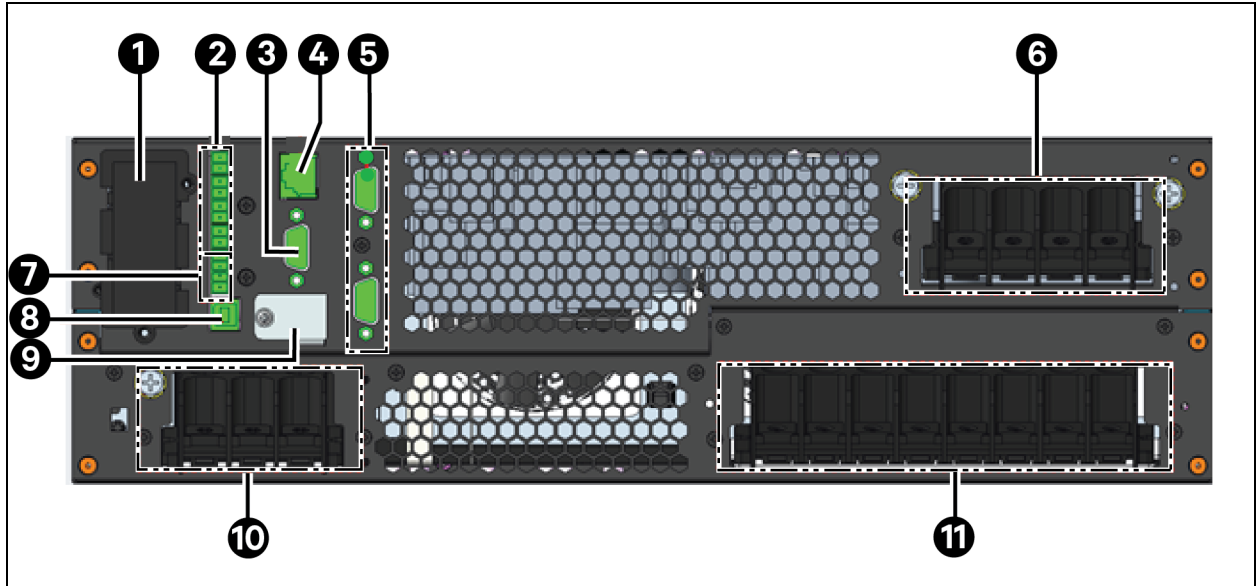

Item	Description
1	Intellislot port
2	Dry contact port
3	RS232 port
4	Ethernet port
5	Parallel/LBS port
6	AC output port
7	REPO port
8	USB port
9	Multifunction port
10	Battery input port
11	AC input port

NOTE: Non-authorized personnel are prohibited from opening the UPS chassis cover.

2.4 Operating Principle

The operating principle of the UPS is shown in **Figure 2.4** below.

Figure 2.4 UPS Operating Principle

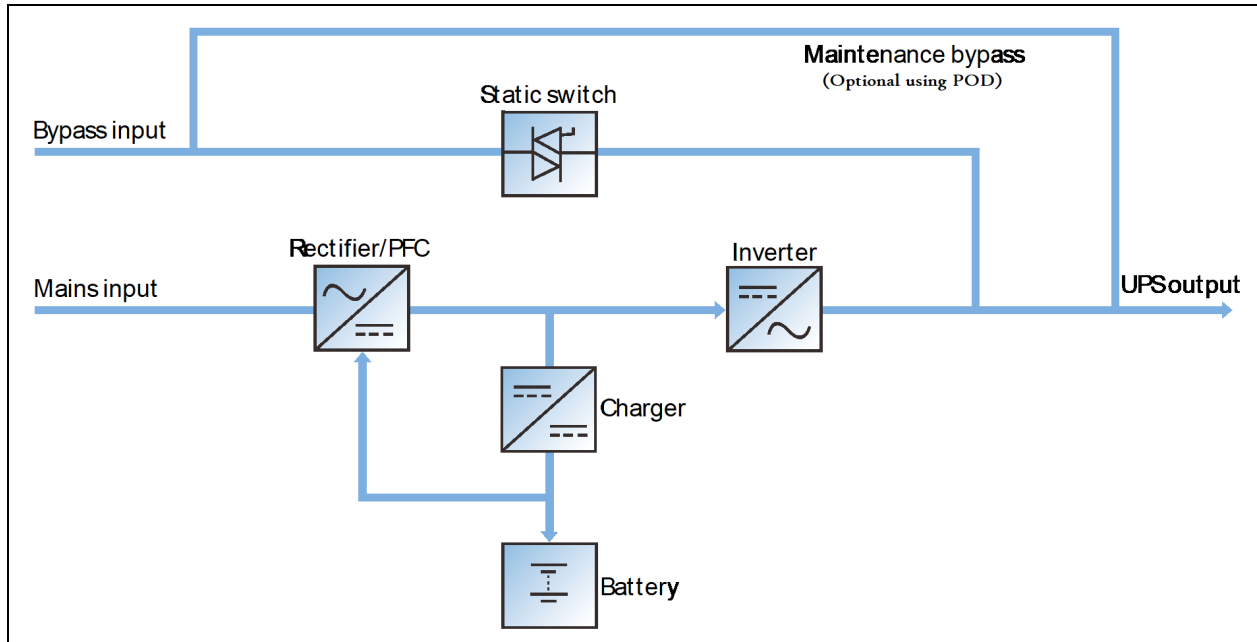

1. The UPS is composed of mains input (main and bypass), rectifier/PFC, charger, inverter, bypass, battery, DSP controller, and output.
2. When the mains input is normal, the rectifier will start, and the charger will charge the battery string. Before turning ON the UPS, the output voltage is bypass voltage, and the mains supplies power to the load through the bypass. After turning ON the UPS, the electronic transfer switch connects the inverter output to the load, and the mains supplies DC power to the inverter through the rectifier/PFC circuit. The inverter then converts DC power into pure sine wave AC power, and supplies the AC power to the load through the electronic transfer switch.
3. When the mains input is abnormal, the rectifier/PFC circuit boosts the battery voltage and supplies it to the inverter. The inverter then converts it into pure sine wave AC power, and supplies the AC power to the load through the electronic transfer switch.
4. After the mains returns to normal state, the UPS will automatically transfer from Battery mode to Normal mode, the mains supplies DC power to the inverter through the rectifier/PFC circuit, and then the electronic transfer switch supplies AC power to the load.

2.5 UPS State and Operation Mode

For the LED indicators introduced in this section, refer to [LED Indicators](#) on page 60.

The UPS state and operation mode include: Normal mode, Bypass mode, Battery mode, ECO mode, Fault state and Maintenance Bypass mode. The operation schematic diagrams of Normal mode, Bypass mode, Battery mode and Maintenance Bypass mode are shown in **Figure 2.5** on the next page to **Figure 2.8** on page 13.

NOTE: Only when the UPS output power distribution unit (POD) is configured, the Maintenance Bypass mode is valid.

2.5.1 Normal Mode

When the mains input is normal, the load is supplied with voltage-stabilizing and frequency-stabilizing power by the mains after processing of the rectifier and the inverter, and meanwhile, the charger is charging the battery. The operation mode is Normal mode.

In Normal mode, the run indicator (green) is on, the alarm indicator is off, and the buzzer is silent.

Figure 2.5 Normal Mode

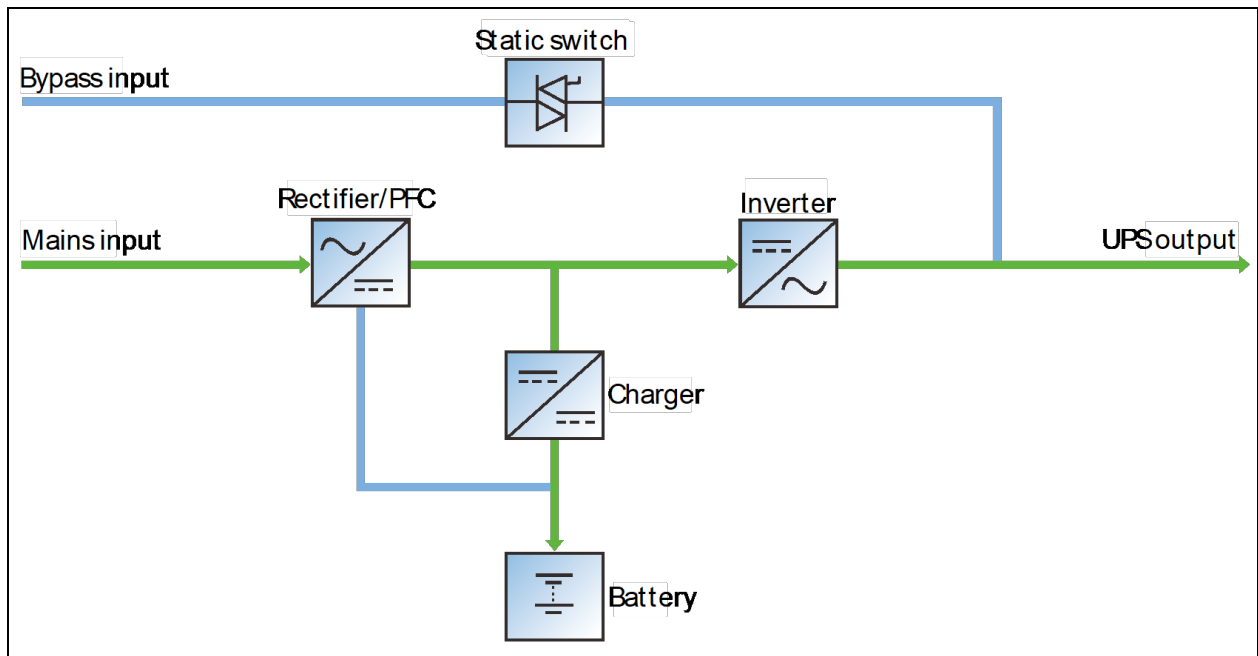

2.5.2 Bypass Mode

If the overload overtime, inverter or rectifier fails during the UPS operation in Normal mode, the UPS will transfer to Bypass mode, that is, the load is powered by the bypass source, which comes directly from the mains input. If the rectifier is normal, the internal charger will charge the battery.

In Bypass mode, the run indicator (green) is on, alarm indicator (yellow) is on, and the buzzer beeps every second. The 'Current' page in LCD will display 'On Bypass'.

Figure 2.6 Bypass Mode

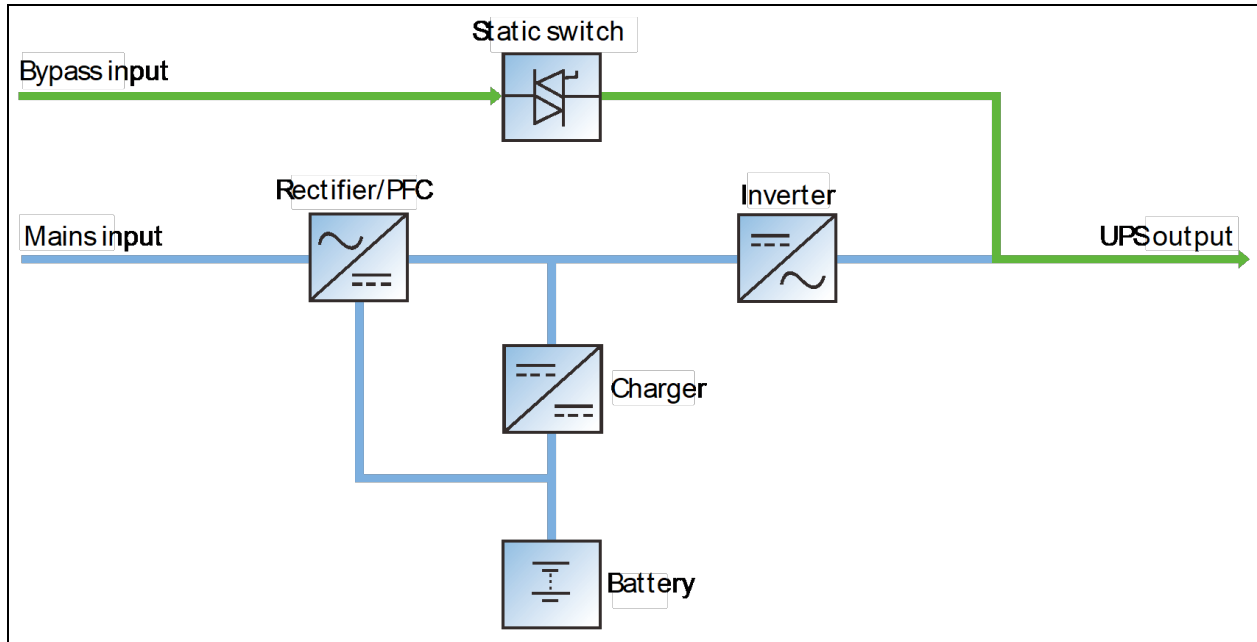

NOTE: In case of mains failure or mains voltage out of range in Bypass mode, the UPS will shut down and stop the output.

2.5.3 Battery Mode

Upon mains failure or voltage out of range, the rectifier and internal charger will stop, and the battery will supply power to the load through the inverter. In Battery mode, the run indicator (green) is on, alarm indicator (yellow) is on, and the buzzer beeps every second. The 'Current' page in LCD will display 'On Battery'.

Figure 2.7 Battery Mode

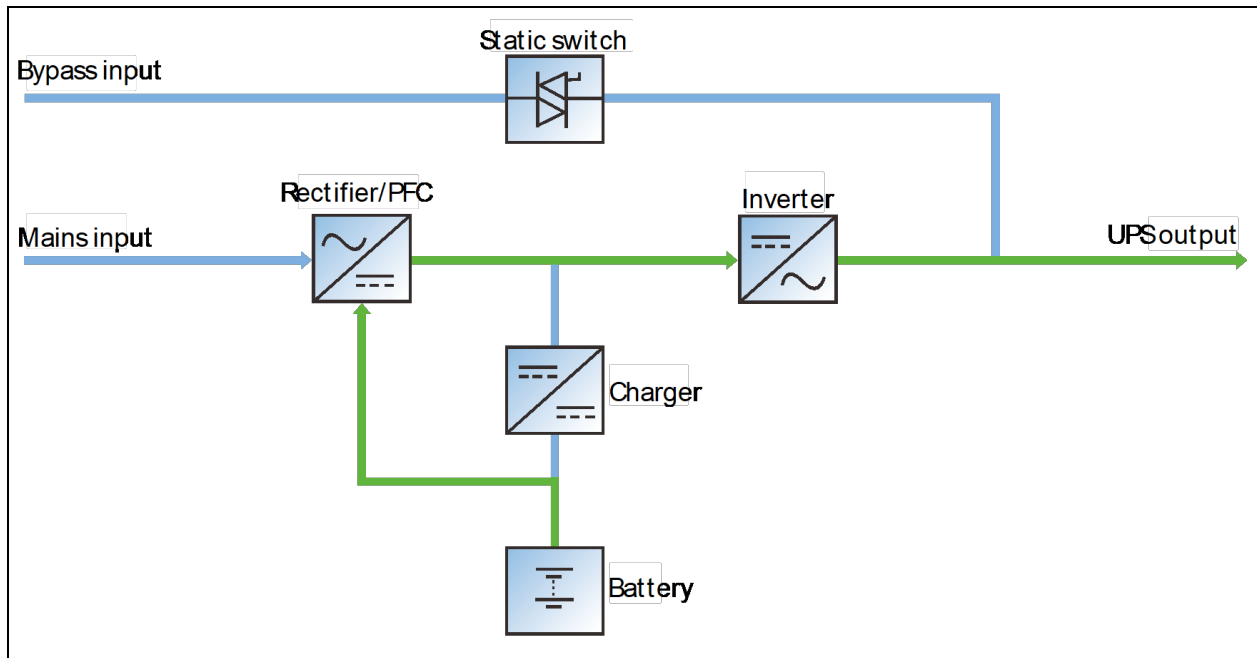

NOTE: Usually the battery has been fully charged before delivering to the customer. However, transportation and storage will inevitably cause some capacity loss. Therefore, it is advised to charge the battery for eight hours before putting the UPS into operation for the first time, to ensure the adequate backup time for battery.

NOTE: The battery cold start function can also be used to start the UPS from the Battery (charged) mode upon mains failure. Therefore, the battery power can be used independently for improving the system availability to some extent.

2.5.4 ECO Mode (for Single UPS with External Battery Only)

In ECO mode, the load is powered by bypass when the bypass voltage is normal, and the load is powered by inverter when the bypass voltage is abnormal. ECO mode is also called as an energy-saving operation mode. For power equipment insensitive to power grid quality, use the ECO mode for power supply through bypass to reduce the power loss.

NOTE: In ECO mode, if the bypass fails or abnormal bypass voltage appears when the output is not overloaded, the UPS will transfer to Normal mode. However, if the bypass failure or abnormal bypass voltage appears when the output is overloaded, the UPS will not transfer to Normal mode, but shut down the bypass.

NOTE: In ECO mode, the efficiency of the UPS is up to 99%.

2.5.5 Fault State

In Normal mode, the UPS will transfer to Bypass mode if the inverter failure or UPS over-temperature appears. In Battery mode (with no bypass mains), the UPS will shut down and stop the output if the inverter failure or UPS over-temperature appears. In UPS Fault state, the alarm indicator (red) will be solid on, the buzzer will keep beeping, and the corresponding fault information will be displayed on LCD.

2.5.6 Maintenance Bypass Mode

If maintenance or repair for UPS is required, switch the load to the Maintenance Bypass through maintenance bypass MCB, to ensure that the power to the load is not interrupted during maintenance and repair of UPS. The maintenance bypass MCB is located on the front panel of the POD, and the capacity meets the requirements of 1+1 load capacities. For more information on POD, see Vertiv™ Liebert® ITA2 30 kVA UPS Power Output Distribution Unit User Manual.

Figure 2.8 Maintenance Bypass Mode

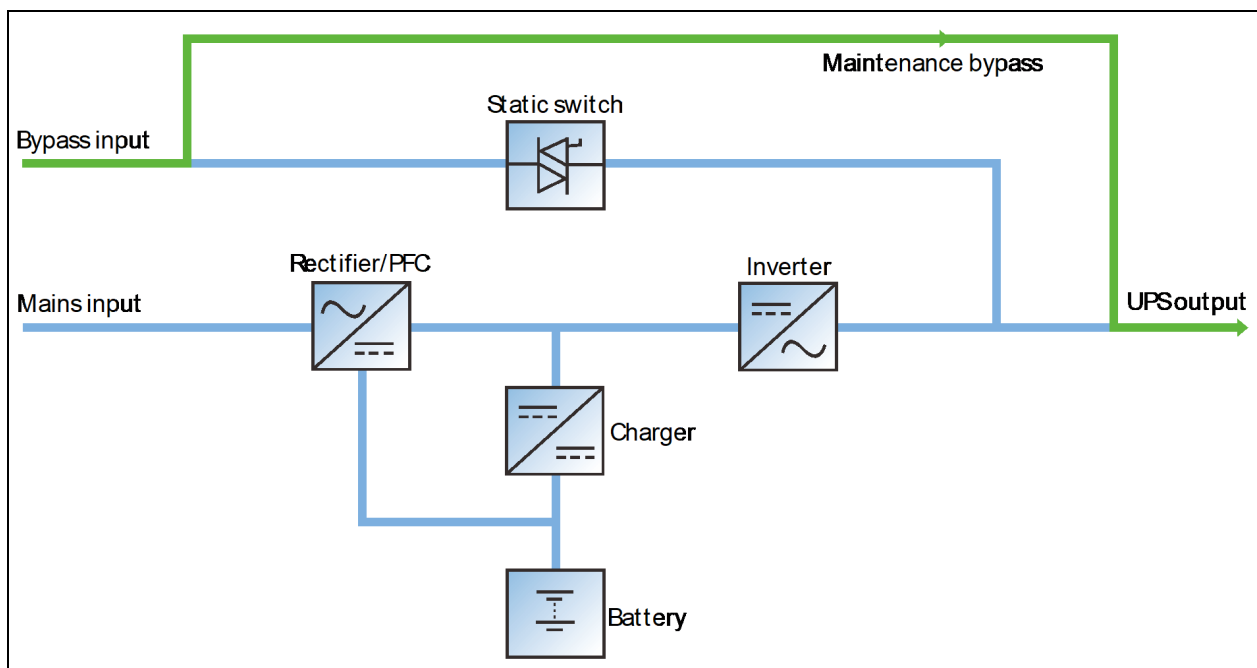

NOTE: When the UPS has malfunctions and can not working normally, contact the nearest Vertiv branch office or local service center. It is prohibited to repair the UPS by yourself, otherwise the personnel injury and damage to the equipment will occur.

2.6 Specifications

The specifications for Vertiv™ Liebert® ITA2 30 kVA UPS are listed in **Table 2.2** below.

Table 2.2 Specifications

Item		Specifications
Input	Rated voltage	380/400/415 VAC (Line voltage)
	Voltage range	176 VAC to 288 VAC, at full load
		100 VAC to 176 VAC, linear derating 100 VAC, at half load
	Rated frequency	50 Hz/60 Hz
	Frequency range	40 Hz to 70 Hz
Power factor	≥0.99, at full load; ≥0.98, at half load	
Bypass	Rated voltage	380/400/415 VAC (Line voltage)
	Rated frequency	50 Hz/60 Hz
	Overload capacity	At: 110% to 125%, 10 minutes; 125% to 160%, 5 minutes; 160% to 210%, 5 seconds
	Bypass voltage	Upper limit: +10%, +15% or +20%; default: +20% Lower limit: -10%, -20%, -30% or -40%; default: -40%
	Bypass frequency range	±5 Hz, ±10 Hz
Output	Rated power	30 kW
	Voltage	380/400/415 VAC (three phase output)
	Frequency synchronization range	Rated frequency ±3 Hz. Configurable range: ±0.5 Hz to ±5 Hz
	Frequency track rate	0.5 Hz/s. Configurable range: 0.2/0.5/1 Hz/s (single UPS), 0.2 Hz/s (parallel system)
	Rated power factor	1
	Crest factor	3:1
	Voltage harmonic distortion	<2% (linear load); <5% (non-linear load)
	Dynamic response recovery time	40 milliseconds
	Overload capacity	At 25 °C (77 °F): 105% to 125%, 10 minutes; 125% to 150%, 1 minute; 150% to 200%, 5 seconds; >200%, 200 milliseconds
	Mains efficiency	up to 96.5%
Battery	Type	Sealed, lead-acid, maintenance-free battery
	Cell No.	32, 34, 36, 38, 40; 32 by default
	Rated voltage	384 VDC to 480 VDC
	Charge current	≤13 A

Table 2.2 Specifications (continued)

Item		Specifications
Transfer time	Mains← → Battery	0 millisecond
	Inverter← → Bypass	Synchronous transfer: 0 millisecond Asynchronous transfer (default): ≤20 milliseconds Or 40, 60, 80, 100 and 120 milliseconds are available
Noise		<60 dB
Panel display mode		Colorful LCD
Safety		IEC/EN62040-1
EMC	Conduction emission	IEC/EN/BS62040-2
	Harmonic current	IEC/EN/BS 61000-3-12
Surge protection		IEC/EN-61000-4-5, endurance level X (6 kV) (live line to earth), level 4 (4 kV) (during live lines); ANSI C62.41, 6kV/20hms
Protection level		IP20
Ambient condition	Operating temperature	50 °C (122 °F) (0 to 40 °C (32 °F to 104 °F) no derating, 0.8 will be derated when above 50 °C (122 °F))
	Storage temperature	+ (battery excluded); -25 °C (-13 °F) + (battery included)
	Relative humidity	5% RH to 95% RH, non-condensing
	Altitude	≤3000 m (9842.52 ft.); derating when higher than 3000 m (9842.52 ft.)
Dimensions W x D x H mm (in.)	With front panel and junction box	430 x 600 x 130 (16.93 x 23.62 x 5.12)
Weight kg (lbs.)	Net weight	23.5 (51.81)
	Gross weight	44.5 (98.1)

This page intentionally left blank

3 Single UPS Installation and Commissioning

This chapter gives information about the installation and commissioning of the single UPS, as each site has its peculiarity, so install the UPS according to the actual conditions of the site.



WARNING! The UPS should be installed by a qualified engineer only according to the information contained in this chapter. If any problem is found, contact to the Vertiv authorized service center immediately. The UPS should not be powered on without approval of the commissioning engineer. For other equipment which is not mentioned in this manual, the detailed information about mechanical installation and electrical installation are delivered with the equipment.

NOTE: 3 phase 5 line for power input. The UPS can be connected to 3 phase 5 line (A, B, C, N, PE) TN, TT and IT AC power distribution system (IEC60364-3).

3.1 Unpacking Instructions

The UPS is delivered in the wooden box and has to be unpacked on the site. See below for unpacking instructions:

1. Remove the *side panels and top cover*.
Use a *hammer or straight screwdriver* to straighten the connection hook that connects the side panels to the top cover, see **Figure 3.1** below.

Figure 3.1 Straightening the Hook



2. Dismantle the cover *plate of the cardboard box*, and remove the *UPS*, as shown in **Figure 3.2** below.

Figure 3.2 Unpacking Cardboard Box

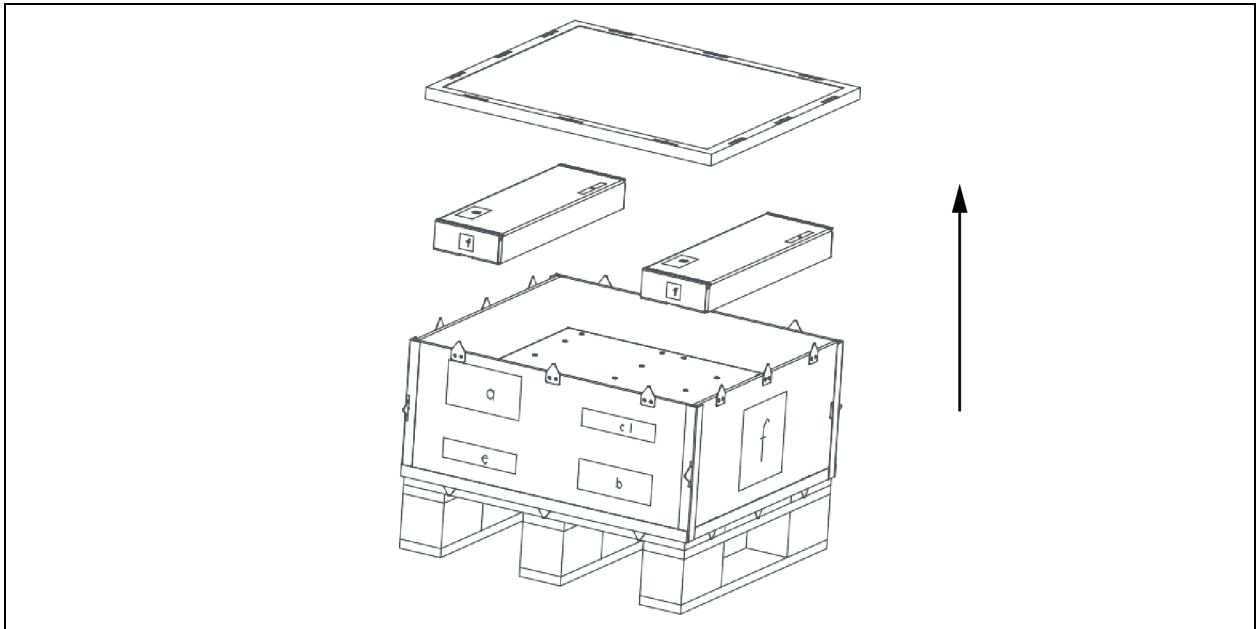

Check the following items:

1. Visually inspect the *UPS and battery* for any transportation damage. In case of any damage, notify the carrier immediately.
2. Check the *accessories and models* against the delivery list. If any problem is found, notify the dealer immediately.

NOTE: In case of damages to the package such as (dirty battery terminal, terminal erosion, rust, or enclosure crack, deformation or liquid leakage) replace it with a new battery. Otherwise, battery capacity reduction, electric leakage or fire may be caused.

3.2 UPS Movement



WARNING! Do not move the UPS through the brackets.

Move the UPS cabinet manually or with the forklift.

NOTE: The battery is very heavy. Use proper method to move and lift the battery, so to prevent any damage to human beings or to the battery terminal. Severe damage to the battery may cause fire.

3.3 Installation Preparation

3.3.1 Location

For extended life of the UPS, the location of installation should meet the following criteria:

- Convenient wiring
- Adequate operator access area
- Good ventilation to meet the heat dissipation requirements
- Free from corrosive gases, (such as sulfur dioxide)
- Free from excessive moisture or heat source
- Free from excessive dust
- Compliance with fire-fighting requirements
- Operating temperature compliant with the specifications
- Operating temperature is in compliance with the specifications

3.3.2 Environmental Requirement

UPS Room

The UPS is designed for indoor installation, which should be installed in a clean and well ventilated environment, ensuring ambient temperature within the specifications.

The internal fans provide forced air cooling for the UPS. Cool air enters the UPS through the ventilation holes on the front panel, and exhausts the hot air through the back ventilation holes. Maintain at least 200 mm (7.87 inch) clearances between the front, rear of the UPS and the wall or adjacent equipment see **Figure 3.3** on the next page, to avoid obstructing the UPS ventilation and heat dissipation. Failure to maintain the minimum distance may lead to raise the internal temperature that will ultimately shorten the UPS life.

NOTE: Increase in the temperature or inappropriate ventilation will raise the internal temperature leading to shortening of UPS shelf life.

If necessary, air conditioning is recommended to control the temperature and humidity around the UPS unit. An air filter should be used in a dusty environment where the UPS is to be operated.

Space Reserved

Figure 3.3 Installation Clearances (Top View of Rack Installation)

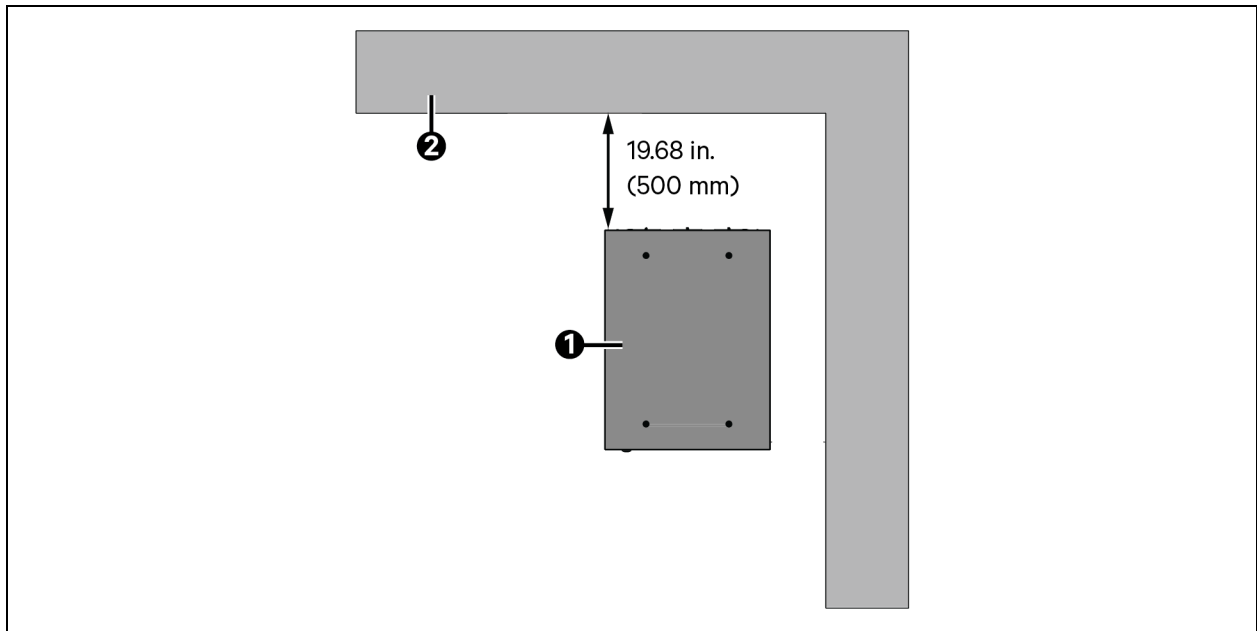

Item	Description
1	Cabinet
2	Wall

NOTE: The UPS should be installed only on the concrete surface or other non-flammable surfaces. As shown in **Figure 3.3** above, the ideal clearance between the rear panel of the cabinet and the wall is 500 mm (19.69 inch). See **Figure 3.3** above. But a minimum of 200 mm (7.87 inch) is must for maintenance clearance should be 200 mm (7.87 inch), it needs to be considered according to the actual situation for the sake of maintenance convenience.

Battery Room

A small amount of hydrogen and oxygen will be generated during the battery charging, therefore, ensure that the fresh air ventilation of battery installation environment meets the EN50272-2001 requirements.

The battery ambient temperature should keep constant, as it is the main factor to affect the battery capacity and life. The battery standard operating temperature is 20 °C (68 °F), operation above this temperature will shorten the battery life, and operation below this temperature will reduce the battery capacity. If the average operation temperature of the battery rises from 20 °C to 30 °C (68 °F to 86 °F), the battery life will be reduced by 50%, if the operation temperature of the battery exceeds 40 °C (104 °F), the battery life will be decreased exponentially. In general, the allowed ambient temperature of the battery is 15 °C to 25 °C (59 °F to 77 °F). The battery should be kept away from heat and ventilation holes.

When the UPS uses an external battery, install a battery protective device (such as fuse or circuit breaker) in areas near the battery, and use the shortest wiring distance for the connection between the protective device and the battery.

Storage Environment

If the UPS is not installed immediately, Vertiv recommends using plastic bags to prevent dust and other corrosive substances from entering the UPS, and the UPS must be stored indoor to protect from the excessive moisture or over-temperature environment. The recommended storage temperature is 20 °C to 25 °C (68 °F to 77 °F), and the storage humidity is 45% to 70% RH. The battery requires dry environment and low temperature, well-ventilated environment for storage.





















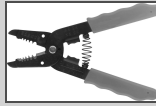

WARNING! Battery Hazards: During the battery storage, the battery must be periodically charged according to the battery instructions. While charging the battery, connect the UPS to the mains temporarily to charge and activate the battery.

3.3.3 Installation Tools

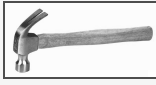

WARNING! For the sake of safety, the installation tools under live operation must be insulated. The recommended tools should be used, see Table 3.1 below for reference only, follow the actual requirement for on-site installation and connection.

Table 3.1 Tools

Name	Tool	Name	Tool	Name	Tool	Name	Tool
Electric hand drill		Adjustable wrench		Electrician knife		Cable tie	
Slotted screwdriver		Cross head screwdriver		Insulating tape		Insulating gloves	
Stepladder		Forklift		Crimping plier		Heat shrinkable tube	
Drill		Wire cutting plier		Insulated torque wrench		Torque screwdriver	
Claw hammer		Diagonal cutting plier		Multimeter		Clip-on ammeter	
Insulating shoes			Antistatic gloves				

3.4 External Protective Devices

The circuit breakers or other protective devices must be installed at the external of the UPS. This section provides general guidance for qualified installation engineer. The qualified installation engineer should be aware of the local wiring regulations and other related information.

3.4.1 Rectifier and Bypass Input

Overcurrent

The appropriate overcurrent protective device should be installed on the mains input power distribution, and the current capacity of power cable and the system overload requirements should be considered in installation, see **Table 3.2** on page 30. For thermomagnetic circuit breakers, see **Table 3.4** on page 31.

Split Bypass

When the system uses split bypass, separate protective devices should be installed for the mains and bypass at the mains input power distribution.

Main/Bypass Backfeed Protection

The UPS has main/bypass backfeed protection function.



WARNING! The same neutral line must be used for the rectifier and bypass input power. For IT power grid system, the 4 pole protective device for 3 phase UPS must be installed at the UPS external I/O power distribution while the 2 pole protective device for 1 phase UPS must be installed at the UPS external I/O power distribution.

Earth Leakage Current



WARNING! The earth leakage current fed by the RFI filter in the UPS, ranges from 3.5 mA to 100 mA. Since earth leakage current is high which can cause false tripping of the circuit breaker. Therefore, we do not recommend to use the MCB with leakage current protection at upstream.

3.4.2 Battery Input

For the ease of UPS installation, the battery is generally installed on the specially designed battery rack or in the battery room. The external battery cabinet should provide DC compatible circuit breakers to provide the overcurrent protection for the UPS and its batteries, the protective device specification is shown in **Table 3.4** on page 31. This circuit breaker should be located as close as possible to the battery connecting terminal, and keep the wiring distance minimum between the power and signal cables connected to the UPS.

3.4.3 UPS Output

The protective device must be installed for the UPS output power distribution. The protective device specification is shown in **Table 3.4** on page 31.

3.5 Mechanical Installation

Two installation modes are available:

1. Tower installation
2. Rack installation

Select an appropriate installation mode according to the actual conditions.

3.5.1 Tower Installation

1. Take out the *support bases* from the accessories, assemble two support bases and a support base extension (accessory) together through the fastenings, as shown in **Figure 3.4** below, and put them onto the flat installation table.

Figure 3.4 Connecting the Support Base with Support Base Extension

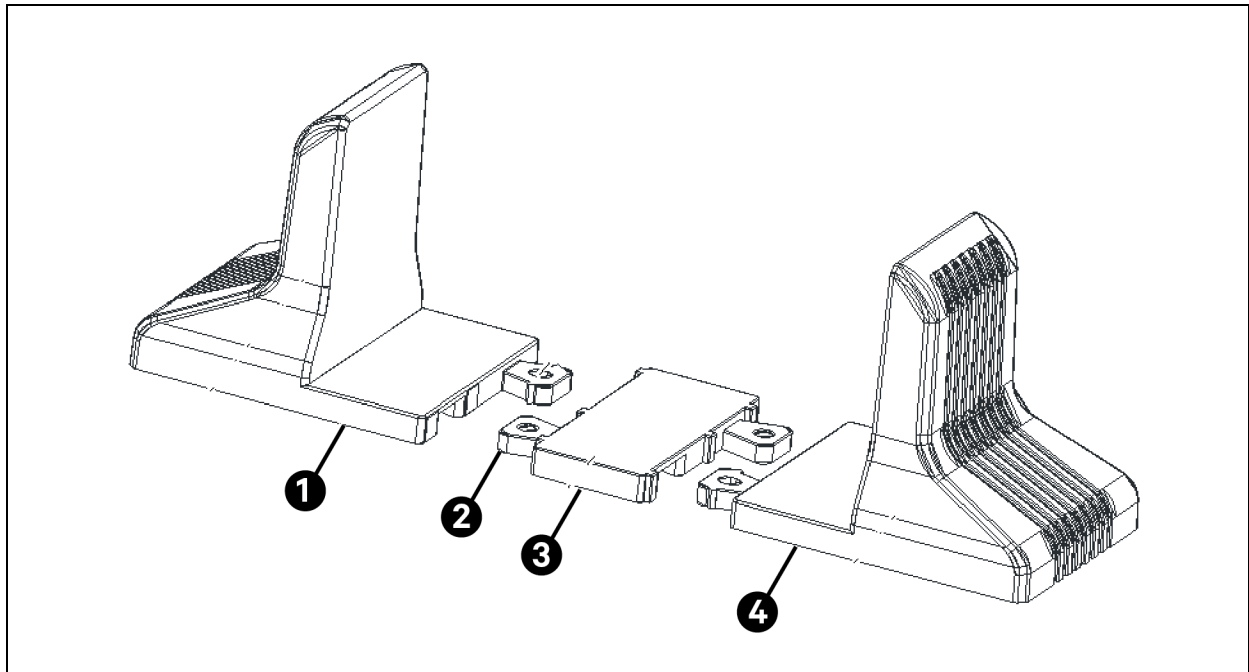

Item	Description
1	Support Base
2	Fastening
3	Support Base Extension
4	Support Base

- Place the UPS on the support bases and support base extensions, as shown in **Figure 3.5** below.

Figure 3.5 UPS Installation Complete

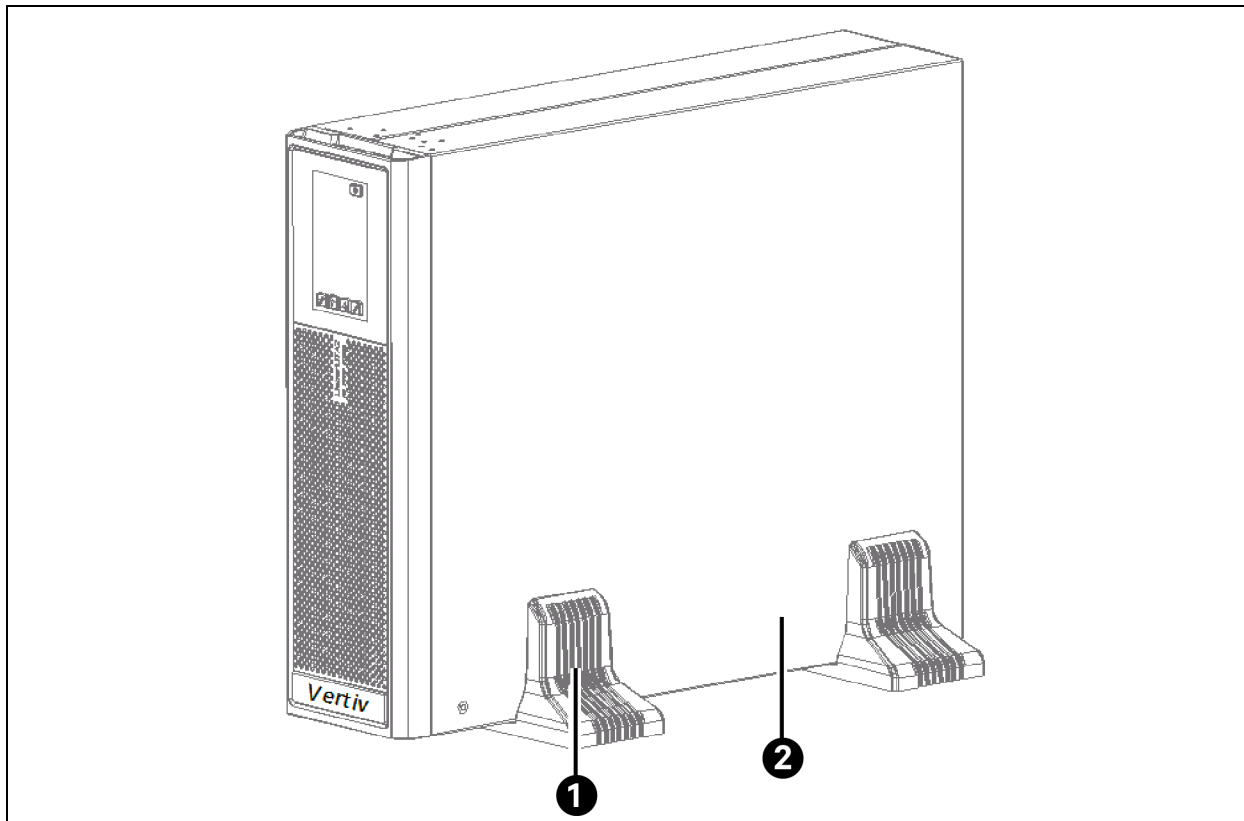

Item	Description
1	Support Base
2	UPS

3.5.2 Rack Installation

Installation procedures for UPS

1. Use *eight M4 × 10 screws* to secure two brackets (accessories) respectively on both sides of the UPS front panel, as shown in **Figure 3.6** below.

Figure 3.6 Installing Brackets

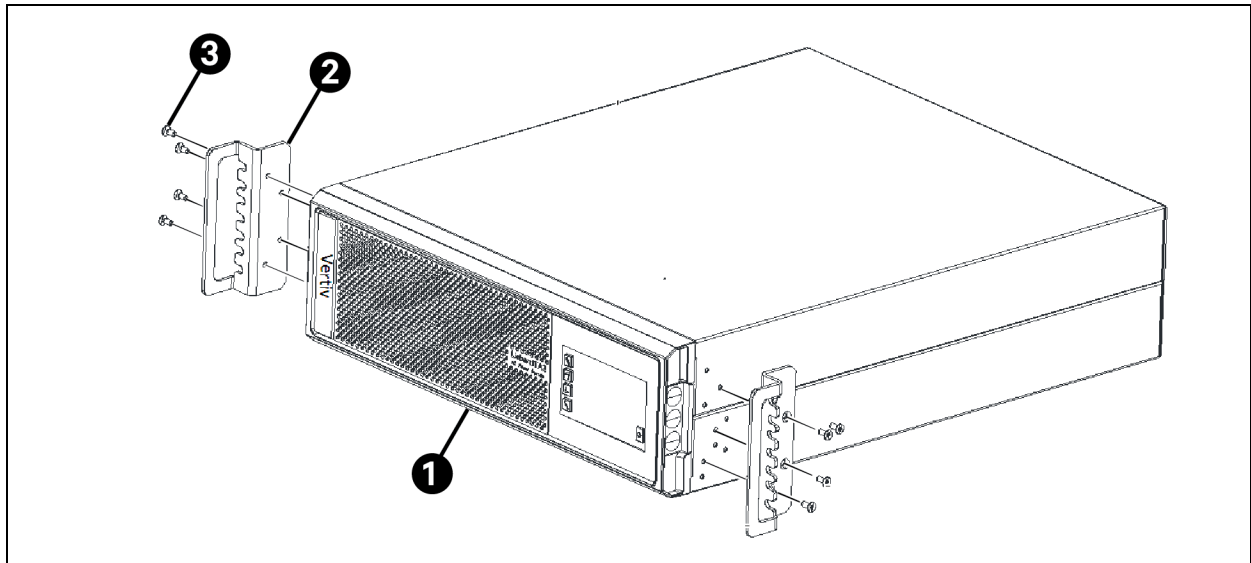

Item	Description
1	UPS
2	Bracket (2 Pcs)
3	Screw (8 Pcs)

NOTE: Do not move the UPS through the brackets.

2. Install the *guide rails*.
Use guide rails while choosing Vertiv™ Liebert® ITA2 30 kVA UPS series UPS and its options, and opt for the rack installation.

The installation procedure for the guide rails is as follows:

- a. Take out the *guide rails* (one left guide rail and one right guide rail), guide rail screws and panel screws from the package, Identify the left guide rail and right guide rail according to **Figure 3.7** below, and confirm its retractable function respectively.

Figure 3.7 Appearance of the Guide Rail

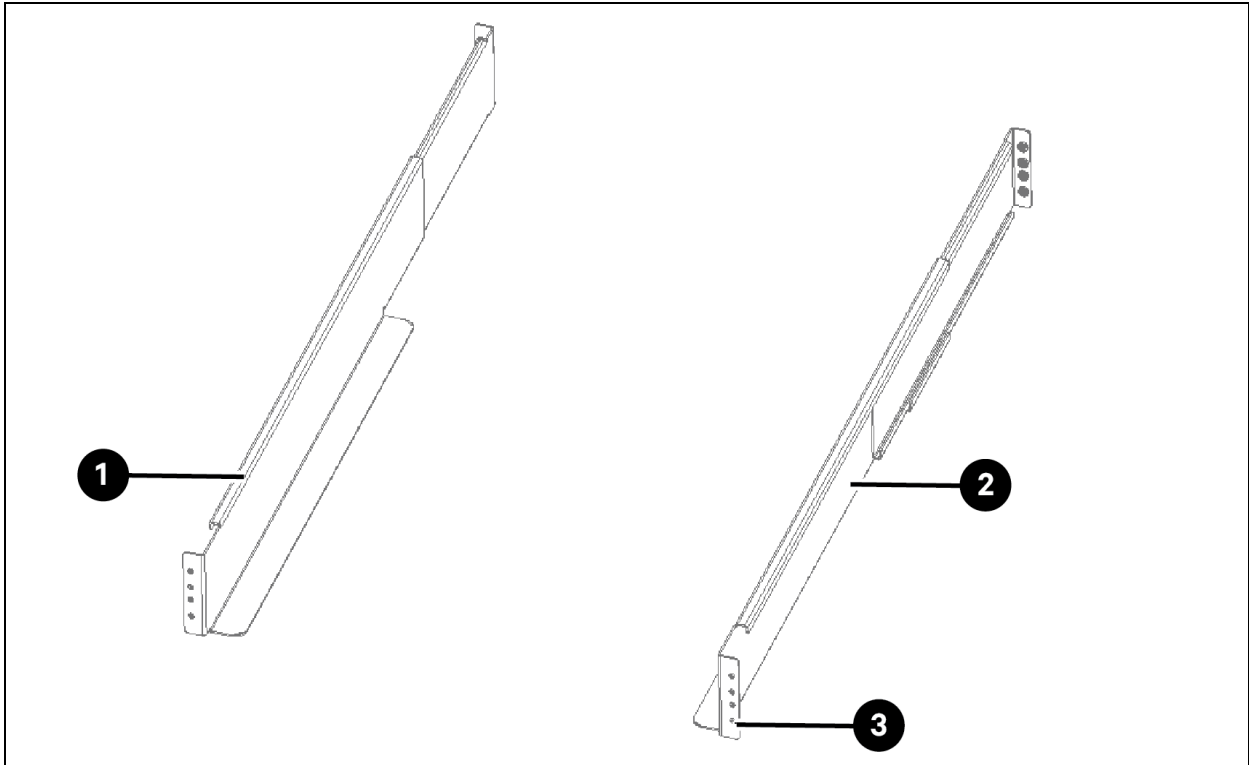

Item	Description
1	Left Guide Rail
2	Right Guide Rail
3	Installation Hole (4 Pcs)

The guide rail screw is shown in **Figure 3.8** below.

Figure 3.8 Appearance of the Guide Rail Screw

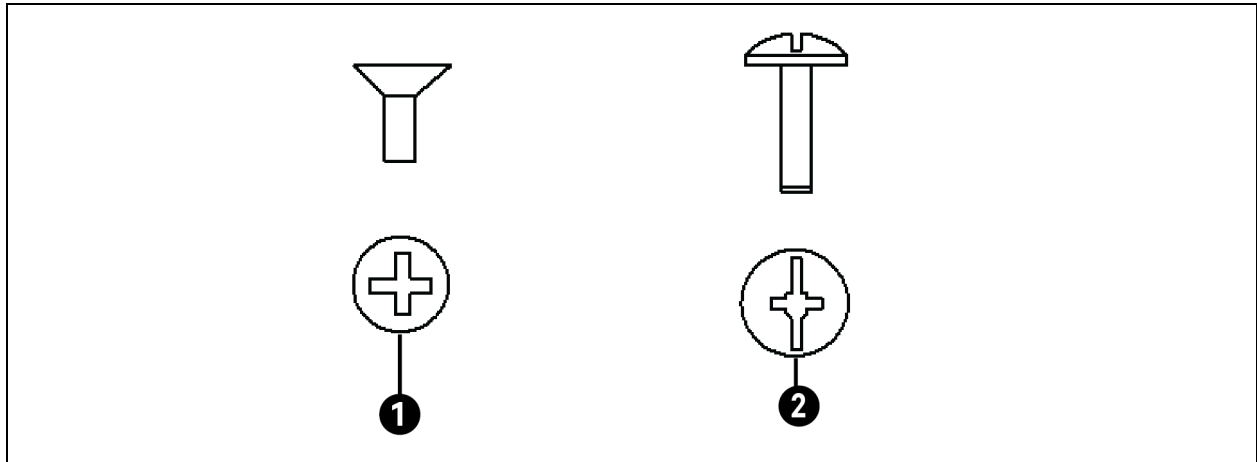

Item	Description
1	Guide Rail Screw
2	Panel Screw

- b. Adjust the *length of the guide rail* according to the dimensions of the rack.

- c. Align the *installation holes* of the guide rail with the square holes of the rack, fix the guide rail onto the rack through the guide rail screws (totally eight), each left guide rail and right guide rail need four guide rail screws, as shown in **Figure 3.9** below.

Figure 3.9 Installing the Guide Rail

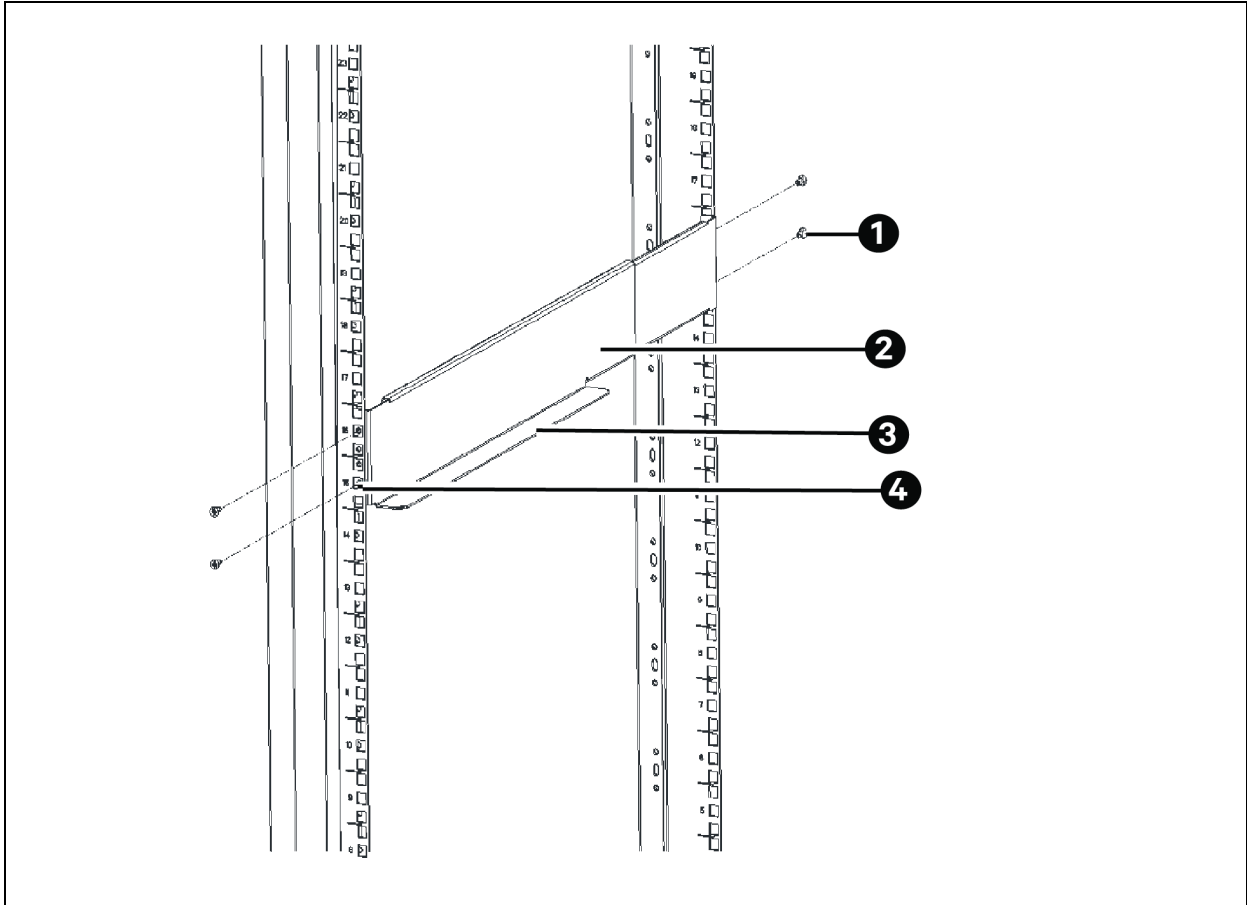

Item	Description
1	Guide Rail Screw (4 Pcs)
2	Guide Rail
3	Guide Rail Holder
4	Square Hole

NOTE: The guide rail holder must be close to the front of the rack.

NOTE: Any end of one guide rail has four installation holes see **Figure 3.7** on page 26, do not use the two installation holes in the middle when fixing the guide rail. It is recommended to use the top and bottom installation hole (from top to bottom, installation hole 1 and installation hole 4).

The guide rail installation is finished, as shown in **Figure 3.10** below.

Figure 3.10 Guide Rail Installation Completed

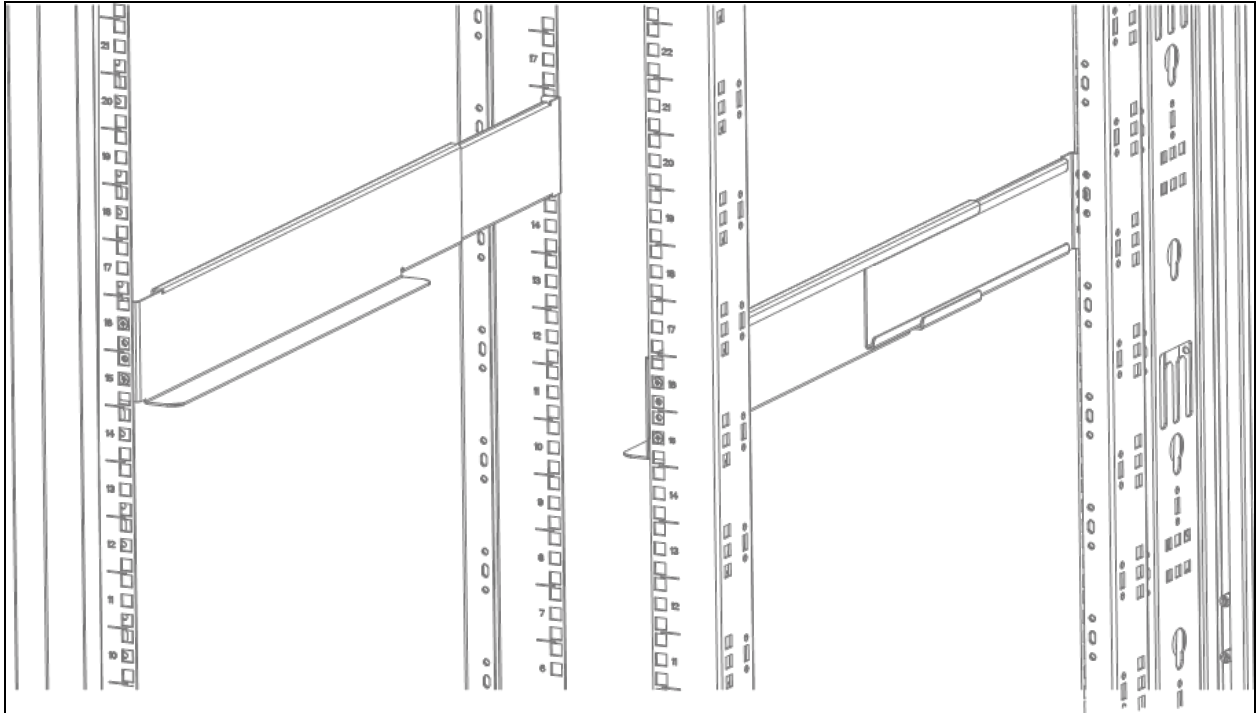

- Place the UPS on the guide rails in the rack, and push it completely into the rack. Use four M6 × 16 screws to fix the UPS in the rack through the brackets, as shown in **Figure 3.11** below.

Figure 3.11 Installing the UPS

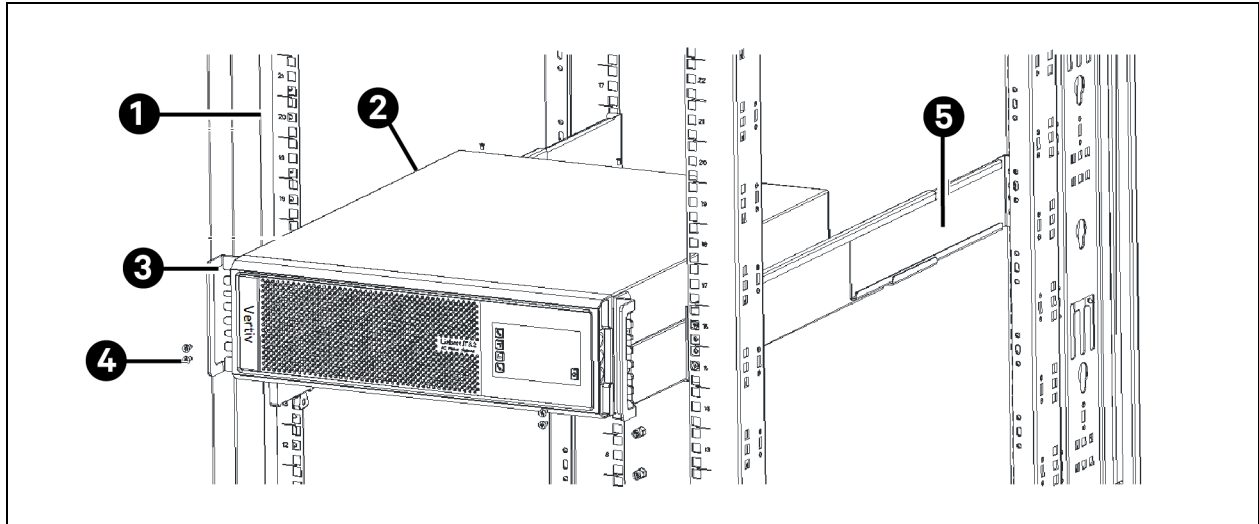

Item	Description
1	Rack
2	UPS
3	Bracket
4	Screw (4 pcs)
5	Guide Rail

3.6 Connecting Power Cables

Input/Output cables and battery cables are required for connection. When connecting the cables, follow the local wiring regulations, consider the environment condition into account, and refer to Table 3B of IEC60950-1.

The maximum current in different operating modes is listed in **Table 3.2** below, the recommended minimum cable CSA is listed in **Table 3.3** on the facing page. Select the appropriate cables according to **Table 3.2** below and **Table 3.3** on the facing page.

Table 3.2 Max. Steady State AC and DC Current

UPS Rated Power (kVA)	Rated Current (A)						
	Maximum Input Phase Current ^{1,2}			Maximum Output Phase Current ²			Maximum Battery Discharging Current (A)
	220 V	230 V	240 V	220 V	230 V	240 V	
30 kVA	62	59	57	45	43	42	86

NOTE: When the battery cables are selected, the maximum allowable voltage drop is 4 VDC according to the current value shown in this table. Do not ring the cables to avoid increasing the electromagnetic interference (EMI).

NOTE: The input mains current of the rectifier and the bypass.

NOTE: Nonlinear load (switch mode power) affects the neutral cable design of the output and the bypass. The neutral cable current may exceed the rated phase current, up to 1.732 times as large as the rated current.

Table 3.3 Single UPS Cable CSA [Unit: mm², Ambient Temperature: 25 °C (77 °F)]

Model	Input	Output	Bypass	Neutral cable	PE	Battery	Battery PE
30 kVA	16	10	10	16	16	25	25

CSA (Unit: mm ²)	Terminal Type
4	OT4-6
6	OT6-6
10	RNBS8-6
16	RNBS14-6
25	RNBS22-6

The recommended Input/Output MCB capability of the UPS is listed in **Table 3.4** below; select the MCBs according to your requirements.

NOTE: The UPS is high leakage current equipment, it is not recommended to use the MCB with leakage current protection.

NOTE: The specified upstream breakers below are required to obtain the conditional short-circuit current rating, ICC at 10 kA symmetrical RMS. The specified upstream breakers should comply with an IEC 60947 series standard.

Table 3.4 UPS I/O MCB Selection

Model	Input Interface	Recommended Capability of Input External MCB	Battery MCB	Output Interface	Recommended Capability of Output External MCB
30 kVA	Terminal block	80 A/C (mains) 63 A/C (bypass)	100 A	Terminal block	63 A/C

NOTE: The 3-in 3-out bypass MCB is used to connect the bypass input upon split-bypass configuration. The main MCB can be used only upon common input configuration.

NOTE: The battery CB should use the 250 VDC or above.

NOTE: The output short circuit current: IRMS = 410.85 A Ipeak = 830 A to 1000 A, duration time: 162 milliseconds.

3.6.1 Connecting Input/Output Cables

The power cables of the UPS should be connected through the I/O terminal block located on the UPS rear panel. As shown in Figure 3.12 below.

Figure 3.12 Terminals Layout of the I/O Terminal Block

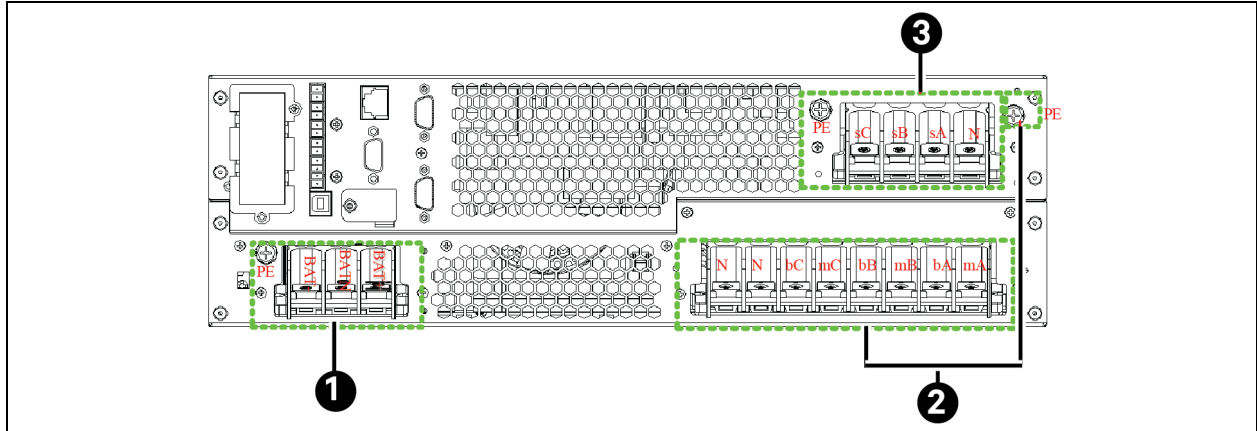

Item	Description
1	Battery terminals
2	Input terminals (mains and bypass)
3	Output terminals

Notes to Figure:

- **Output terminals:** sA, sB, sC; Output PE terminal: PE; Common N:N
- **Input terminals:** Mains input terminals: mA, mB, mC; Bypass input terminals: bA, bB, bC; Common N:N; Input PE Terminals: PE
- **Battery terminals:** BAT+, BATN, BAT-; Battery PE Terminal: PE
- The Shorting copper bar of the 3-in 3-out (common input) is linked before delivery.

NOTE: After the power cables connection, the protective cover board of the Input/Output terminal block must be reinstalled to avoid electric shock.

NOTE: The aperture of the wire guard ring on the junction box needs to be cut according to the size of the wire diameter, to meet the IP20 requirements.

NOTE: The recommended specification of the waterproof cable gland for the junction box is M50 x 1.5, and the outer diameter of the nut should be ≤55 mm (2.17 inch).

Power Distribution Mode

There are two modes for UPS power distribution: using the single power output distribution unit (POD, optional) provided by Vertiv, self-distribution.

According to user's requirements, the I/O cable connections are divided into two types: 3-in 3-out, common input configuration (factory default), 3-n 3-out, split-bypass configuration.

Shorting Copper Bar of 30 kVA

Figure 3.13 Bypass Shorting Copper Bar (2 Pin Copper Bar)

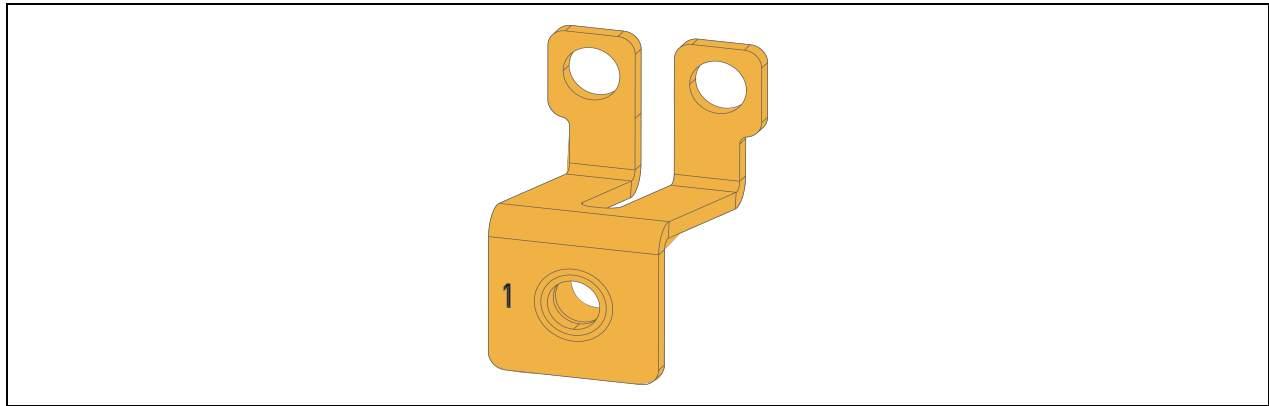

The I/O cable connection procedures of the self-distribution for the four types are as follows:

1. 3-in 3-out, common input configuration as shown in **Figure 3.14** below.
 - a. Before delivery, short connect mA and bA, mB and bB, mC and bC of the I/O terminal block of the UPS using the three shorting copper bars 1 respectively.
 - b. Connect the mains input live wires (L1, L2, L3) to the three shorting copper bars 1, and connect input N line and input PE line respectively to the I/O terminal block (N and PE terminals) of the UPS.
 - c. Connect the standard output live wires (phase-A, phase-B and phase-C) respectively to the output terminals sA, sB and sC. Connect the output N line and output PE line respectively to the output terminals N and PE. As shown in **Figure 3.14** below.
 - d. As shown in **Figure 3.14** below, guide the battery positive cable, battery N cable and battery negative cable through the cable hole of the junction box, then respectively connect them to BAT+, BAT N, BAT-, and PE, then fasten the fixing screws.

Figure 3.14 Wiring Diagram (3-in 3-Out, Common Input Configuration)

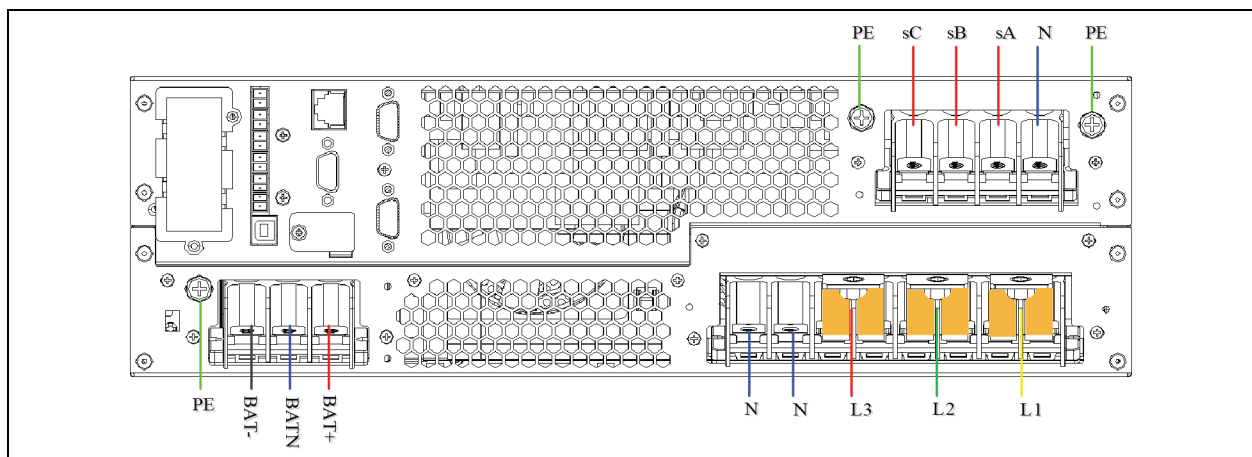

2. 3-in 3-out, split-bypass configuration as shown in **Figure 3.15** on the next page
 - a. Remove the three shorting copper bars 1 installed before delivery.

- b. Connect the input live wires (phase-A, phase-B and phase-C), input N line and input PE line respectively to the I/O terminal block (mA, mB, mC, N and PE terminals) of the UPS. Connect the bypass input live wires (phase-A, phase-B, phase-C and N) respectively to the input terminals bA, bB, bC, and N.
- c. Connect the standard output live wires (phase-A, phase-B and phase-C) respectively to the output terminals sA, sB and sC. Connect the output N line and output PE line respectively to the output terminals N and PE. As shown in **Figure 3.15** below.
- d. As shown in **Figure 3.15** below, lead the battery positive cable, battery N cable and battery negative cable through the cable hole of the junction box, then respectively connect them to BAT+, BAT N, BAT- and PE, then fasten the fixing screws.

Figure 3.15 Wiring Diagram (3-in 3-out, Split-Bypass Configuration)

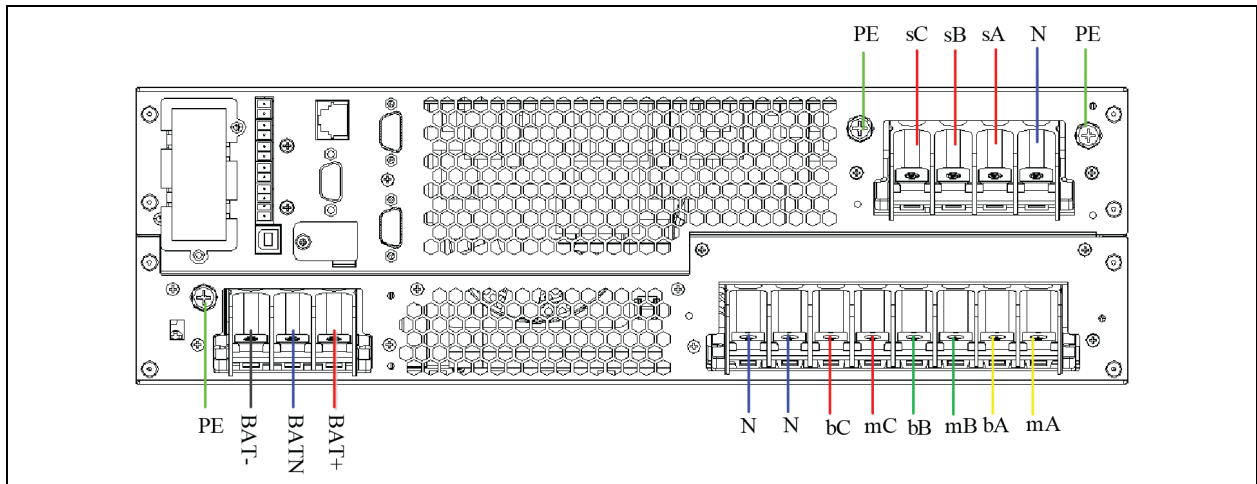

WARNING! Before commissioning UPS, check the safety insulation of wiring cable.

3.6.2 Connecting Battery Cables

Work cautiously with the batteries associated with the UPS. When all the blocks are connected, the battery string voltage can be up to 432 VDC. This is potentially lethal. Follow the precautions for high voltage operation. Only qualified personnel are allowed to install and maintain the battery. To ensure safety, the external batteries are to be installed inside a lockable cabinet or in a purpose-designed, dedicated battery room, so that they are only accessible to qualified service personnel.

1. All the battery cabinets or battery racks must be connected and properly grounded.
2. When multiple batteries are used, they should be connected in series and then in parallel. Before loading and power-up, it must be detected that the total voltage of the batteries is as specified. The negative and positive poles of the batteries must be connected to the negative and positive battery terminals of the UPS according to the labels on the battery and UPS.



WARNING! Risk of equipment damage. Can cause injury or death. Do not reverse the polarity of the battery cables. It may cause explosion and fire that may result in battery and UPS damage or even human injury.

3. Connect the BCB terminal first when connecting the cable between the BCB terminal and battery.
4. The bending radius of the cable should be larger than 10D, wherein D is the outer diameter of the cable.

NOTE: Do not pull the battery cable or the cable terminal, when the battery cable is connected.

NOTE: Do not cross the battery cables during the connection, and do not tie the battery cables together.

NOTE: Before connecting the battery cables, confirm that the actual battery cell number and capacity are consistent with the parameter settings on the LCD menus. Incorrect settings can cause overcharging of the battery.

NOTE: Do not reverse the polarity of the battery cables.

NOTE: Before replacing the battery module and connecting the battery cables, disconnect the DC battery MCB, power off the UPS completely, and put isolation tapes on the terminals.

NOTE: It is recommended that the battery cable should not be longer than 3 meters. Otherwise, need to increase the corresponding restraint measures.

Installing Battery insulating Plate

The battery terminals need insulating plates to guarantee the sufficient insulation distance between the battery external cables connection, then avoid the faults like arcing, short circuit occur.

Installation steps are as follows:

Figure 3.16 Installing Battery Insulating Plates

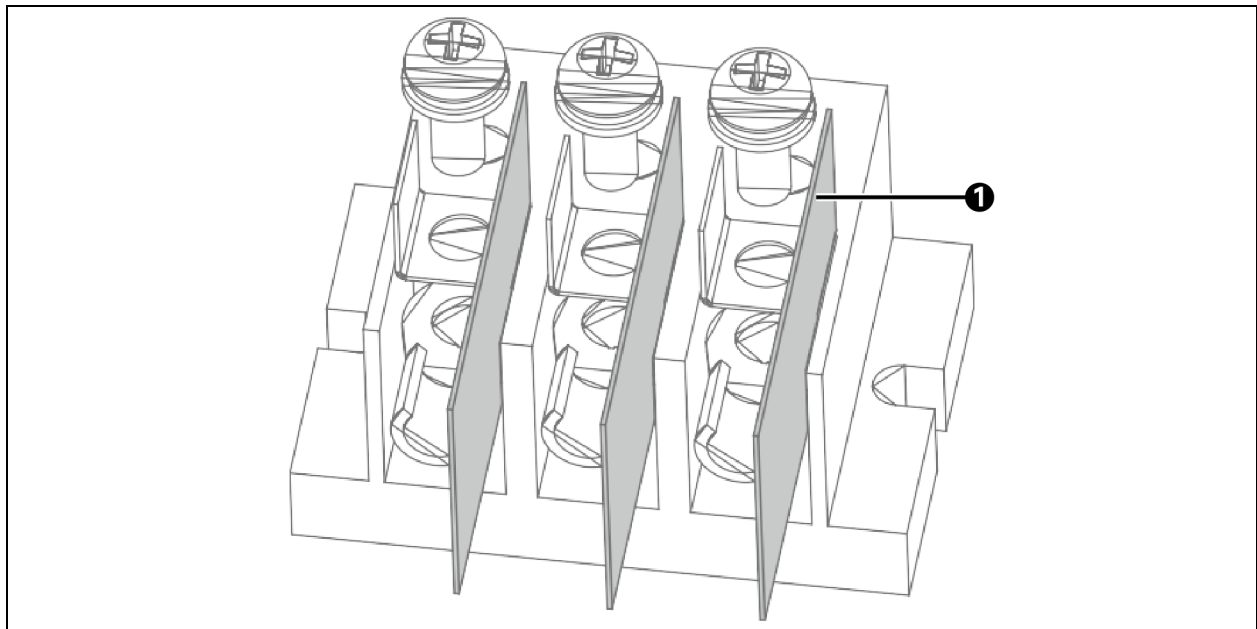

Item	Description
1	Battery insulating plate

1. First crimp the user external cable on the battery terminals, **Figure 3.16** above shows the OT terminals.
2. Crimp the battery insulating plates, and use the screws to fasten the OT terminals and insulating plates together onto the terminal block.

Installing Battery

1. Before installation, inspect the appearance and accessories of the battery, and carefully read this manual and the user manual provided by the battery manufacturer.
2. Maintain at least 10 mm (0.39 inch) clearances between the front, rear, side panels of the battery and the wall or adjacent equipment to keep well ventilated.
3. Maintain some clearances between the top of the battery and the upper baffle for the ease of monitoring and maintenance of the battery.
4. Install the batteries from the bottom to the top to prevent too high center of gravity. Place the battery well to avoid shaking and impact.

Connecting External Battery String

The default battery number of the UPS is 32-block (16-block for positive and 16-block for negative). The external battery string connection principle diagrams of the self-distribution are shown in **Figure 3.20** on page 41. The required battery backup time (i.e., the time for battery to supply load upon mains failure) is subject to the ampere hour value of the battery. Sometimes, it is necessary to connect several strings of battery in parallel.

When several strings of battery are paralleled to increase the battery backup time, disconnecting device should be equipped, so that the maintenance operation on a certain battery string does not affect the normal operation of other battery strings.

One DC battery MCB must be added between the battery strings and the UPS. See **Figure 3.17** on the facing page. The voltage of the battery string is DC high voltage, the capacity of the MCB and output cables is listed in **Table 3.4** on page 31.



WARNING! The battery connecting terminal should not be subject to any force, such as the pulling force or twisting force of the cable, to avoid damage to the internal connection of the battery. Severe damage to the battery may cause fire. The battery should be firmly and reliably connected. After the connection is completed, the screw connections between all the terminals and the batteries should be calibrated. The requirements on torque specified in the specifications or user manual provided by the battery manufacturer should be satisfied. The connections between all the wiring terminals and the batteries should be inspected and tightened at least once a year. Otherwise it may cause fire. Batteries of different types, names or newness should not be used together. Otherwise, the battery inconsistency will cause frequent over-discharge or under-charge of certain battery. At last, the battery will have premature failure, and the entire string of battery will have insufficient backup time.

Figure 3.17 Battery String Connection Principle Diagram

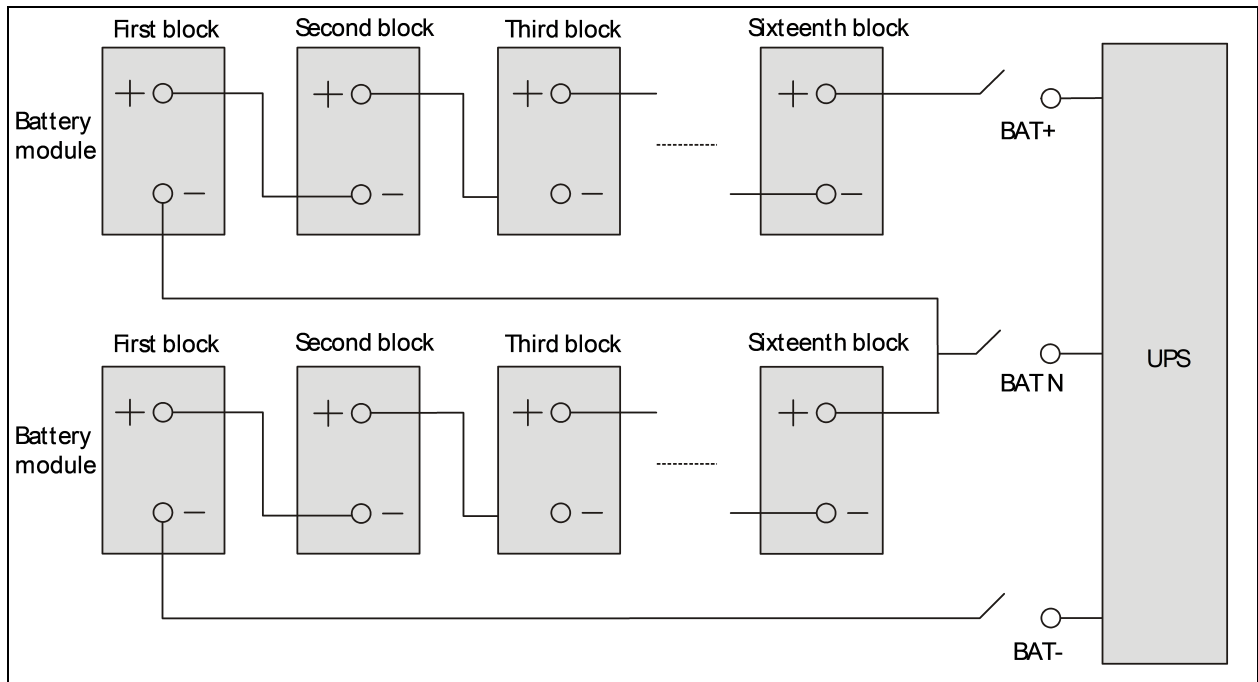

Battery Module Cable Connections

Figure 3.18 Cable Connections between UPS and 3U Battery Module

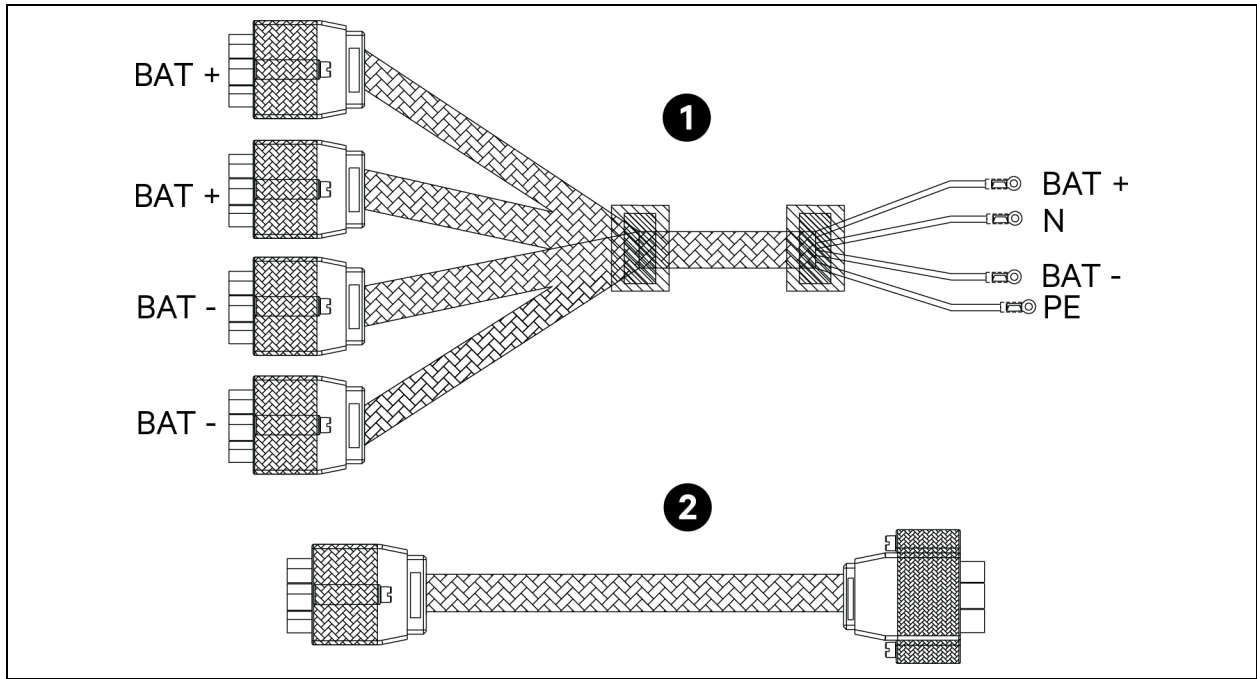

Item	Description
1	The connection cable between the UPS and the battery module is of model ITA-40k00BCI01L1.
2	Parallel cable between battery modules, used to expand the number of battery modules, model is ITA2-BCI0020k02L1.

- When a 30 kVA UPS is connected to four battery modules, the connection cable ITA-40k00BCI01L1 needs to be selected. The battery module cable is shown in **Figure 3.19** on the facing page. The BAT+, BAT-, BAT N and PE ends of the cable are connected to the corresponding terminals of the UPS, while the other ends (2 BAT+, 2 BAT-) are respectively connected to the interface A of the battery module. One end of the battery module network cable is connected to the control network port corresponding to the UPS, and the other end is connected to the network port of interface A of the battery module.
- When expanding the battery module, the connection cable ITA2-BCI0020k02L1 needs to be selected. The battery module cable is shown in **Figure 3.19** on the facing page. The interface A end of the cable is connected to the corresponding interface A of the first group of battery modules, and the other end interface B is connected to the interface B of the second group of battery modules. One end of the battery module network cable is connected to the network port of interface A of the first group of battery modules, and the other end is connected to the network port of interface B of the second group of battery modules.

Connect the ITA2 30 kVA 400 V UPS to a System of 4-Group Battery Modules (8 Battery Modules):

Figure 3.19 Schematic Diagram of the Connection between UPS and Eight 3U Battery Modules

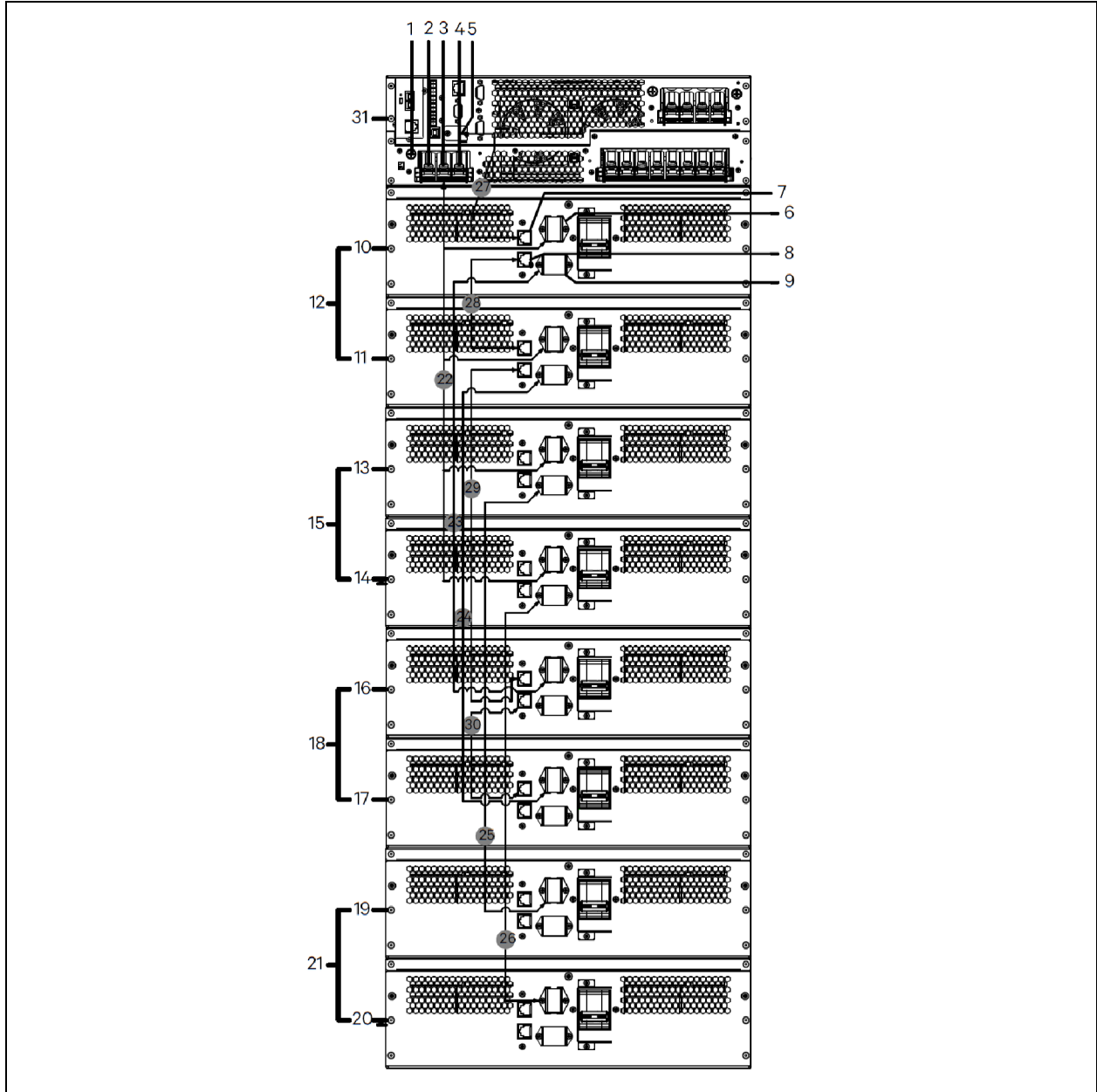

Item	Description	Item	Description
1	PE screw	14	Battery module 4
2	BAT -	15	Battery string 2 (BAT -)
3	BAT N	16	Battery module 5

Item	Description	Item	Description
4	BAT+	17	Battery module 6
5	COM port (RJ-45)	18	Battery string 3 (Parallel BAT+)
6	Battery module interface A	19	Battery module 7
7	Network port of battery module interface A	20	Battery module 8
8	Net port of battery module interface B	21	Battery string 4 (Parallel BAT-)
9	Battery module interface B	22	Cables connection between UPS and battery module, ITA-40k00BCI01L1
10	Battery module 1	23 to 26	Parallel cables between battery modules, ITA2-BCI0020k02L1
11	Battery module 2	27 to 30	Network cable of battery module
12	Battery string 1 (BAT+)	31	UPS
13	Battery module 3		

3.7 Single UPS Commissioning

3.7.1 Check Before Startup

1. Check and confirm that the power distribution mode of the UPS and the POD (if configured) is correct, that the connection of the power cables and signal cables is correct and there is no short circuit.
2. Check that the battery installation and the cable connection are correct, that the positive pole and the negative pole of the battery are correct.
3. Measure and confirm that the mains voltage and frequency are normal.
4. The output terminals of the UPS and the POD (if configured) are energized upon the startup. If the load is connected to the output terminals, make sure that the power to the load is safe.

3.7.2 Startup Interface

If the system is first startup, only mains input mode can be used, and the LCD screen will display the startup interface, see Figure 3.20 below.

Figure 3.20 Startup Interface

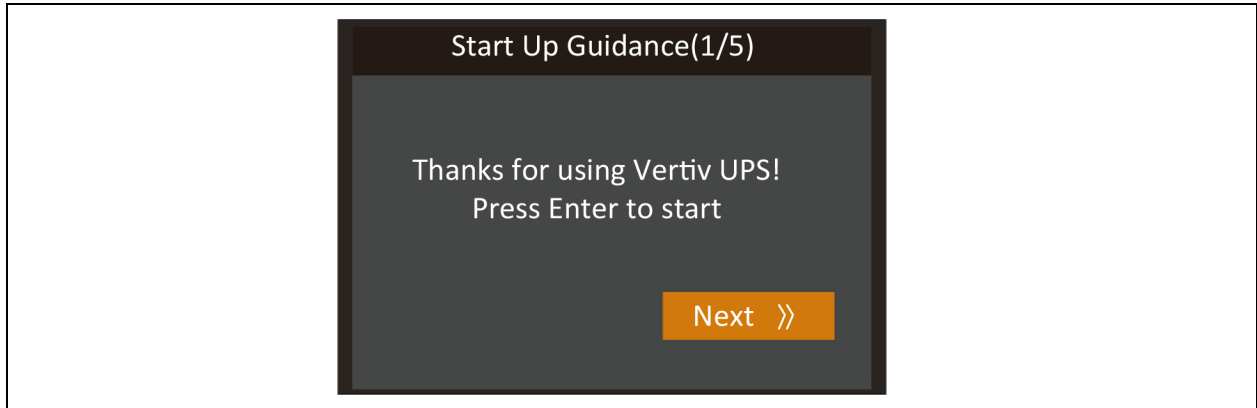

3.7.3 Normal Mode Startup

1. Close the *external output MCB* and *input MCB* of the UPS one after other. If the single POD is selected to connect with the UPS, close the input MCB, bypass MCB and output MCB of the POD.



WARNING! Once the UPS external output MCB or the POD output MCB are closed, the output terminal block of the UPS, output terminal block of the POD and power distribution end of the load will be live. Pay attention to personal safety to avoid electric shock. Check whether it is safe to feed power to the load.

The rectifier runs in normal state for about 30 seconds, the startup of the rectifier is finished.



2. Finish and check the parameter settings of the single UPS.
 - a. At main menu screen, press the  or  key to select *Settings*, and press the  key to enter the interface shown in Figure 3.21 below.

Figure 3.21 Main Menu Screen



- b. Press the  or  key to select and set corresponding parameters (taking 'Output' as an example). As shown in **Figure 3.22** below.

Figure 3.22 Output Interface

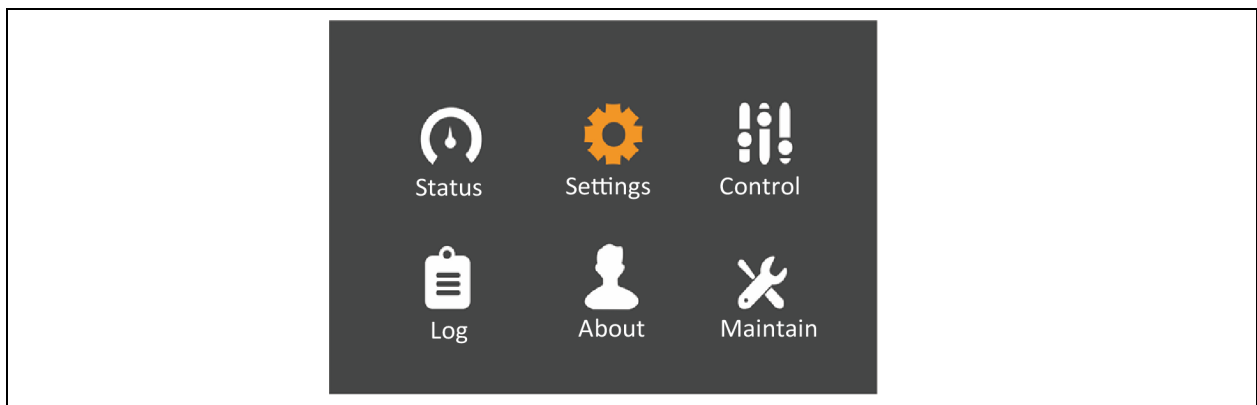

- 3. After setting corresponding parameters, press the power button for 2 seconds, and the LCD prompts a dialogue box shown in **Figure 3.23** below.

Figure 3.23 Turning ON UPS

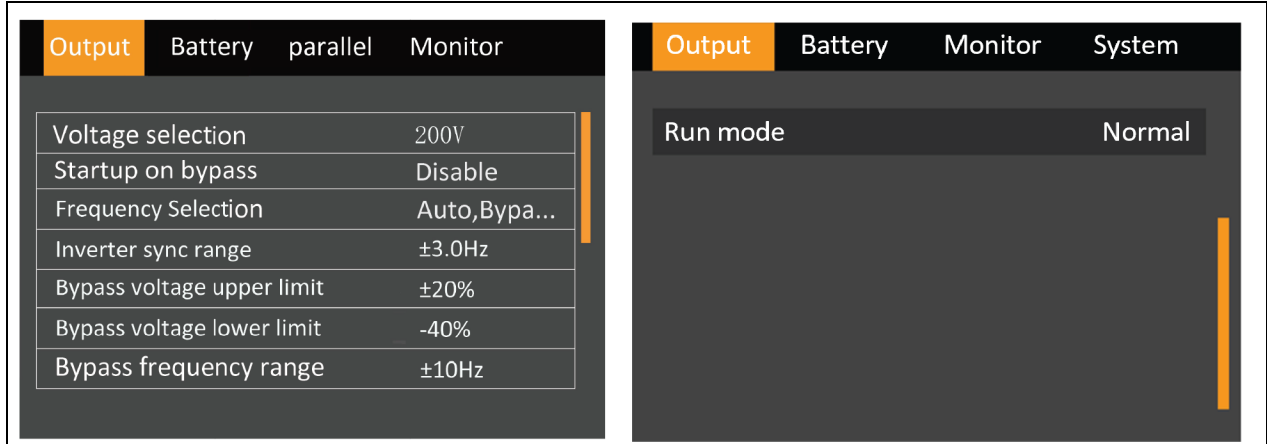
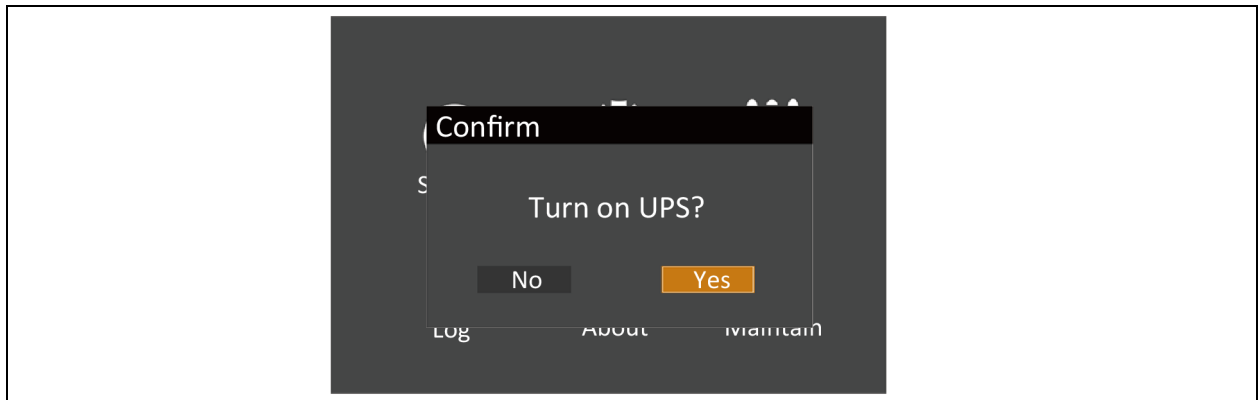

After selecting YES, the run indicator (green) blinks, the inverter starts, and the run indicator turns on.

- 4. Measure whether the inverter output voltage is normal.
- 5. If the battery is not connected, the alarm indicator is yellow. If the battery is connected, the alarm indicator turns off.

3.7.4 Battery Mode Startup

1. Close the *battery MCB*, and press the power button on the UPS front panel for 2 seconds, the LCD displays the startup screen. The alarm indicator will be yellow, and the buzzer will beep continuously after the rectifier finishes the startup.
2. Press the *power button* for 2 seconds, the LCD prompts a dialogue box shown in **Figure 3.24** below.

Figure 3.24 Turning ON UPS

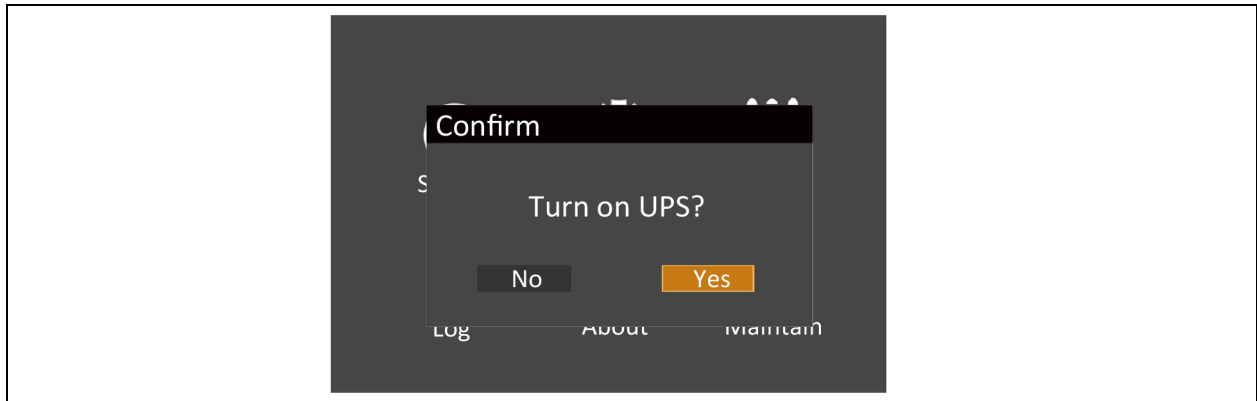

After selecting YES, the inverter starts, and the run indicator (green) is on.

This page intentionally left blank

4 Parallel UPS Installation and Commissioning

This chapter gives information about the features, requirements, installation and commissioning of the parallel system.

The UPS parallel system provides the user with $N + X$ ($2 \leq N + X \leq 4$, $X = 0$ or 1) parallel configuration where,

- N stands for the basic parallel sets and,
- X stands for the redundant sets.

1+1 parallel POD (optional) can provide safe and reliable power distribution function for the parallel system. The 1+1 parallel system only needs one 1+1 parallel POD, if N is not less than two, the external self-distribution will be required for the parallel system.

4.1 Features

1. The software and the hardware of each of the UPS in parallel system are same as those of the single UPS. The basic parameters of the parallel system can be set through the LCD see [Parallel System Parameters Setting](#) on page 53 for details, and the detailed parameters can be set through the background software (For service engineers only). For all UPS of the parallel system, the requirements of the parameter settings are same.
2. The parallel cables form a ring connection see [Connecting Parallel Cables](#) on page 49 for details, to provide reliability and redundancy for the system. The intelligent parallel logic provides the user with maximum flexibility. For example, each UPS in the parallel system can be switched off or on in random order; seamless transfer can be achieved between Normal mode and Bypass mode, and the transfer is automatically recoverable: that is, after the overload is removed, the system will return to the original operation mode automatically.
3. The total load of the parallel system can be identified through the LCD of each UPS.

4.2 Requirements

A UPS system consists of multiple parallel-connected UPS is equivalent to a large UPS system. Nevertheless, it provides increased system reliability.

To ensure equal utilization of all UPS and compliance with relevant wiring regulations, the following requirements must be met:

1. Each UPS in the UPS large system must have the same capacity. The UPS must be connected to the same bypass source.
2. The bypass input power and the rectifier input power must be connected to the same neutral line input terminal.
3. If a residual current detector (RCD) is required, it must be set correctly and installed before the same neutral line input terminal, and it must monitor the protective earth current of the system. See Warning: High leakage current of [Important Safety Information](#) on page 1.
4. The output of each UPS must be connected to the same output bus.
5. Because the UPS parallel system is not fitted with any auxiliary contact detection devices for the output MCB or the maintenance bypass MCB of the UPS, removing the single UPS from the parallel system before maintenance and adding the single UPS into the parallel system after maintenance must be conducted strictly following the procedures provided in [Transfer Procedures between Operation Modes](#) on page 81. Failure to follow the given instructions may affect the reliability of the load power supply.

4.3 Mechanical Installation

For the rack installation of the 1+1 parallel system, the mechanical installation method of the parallel system is as follows:

1. The installation method of 1+1 parallel UPS is the same as that of the single UPS. For more information on installation, see [Mechanical Installation](#) on page 23.
2. The UPS should be installed at the bottom; and the 1+1 parallel POD should be installed on the top to facilitate the cable connection and operation. The installation method of 1+1 parallel POD is the same as that of the UPS, see [Figure 4.1](#) below.

Figure 4.1 1+1 Parallel System Installation

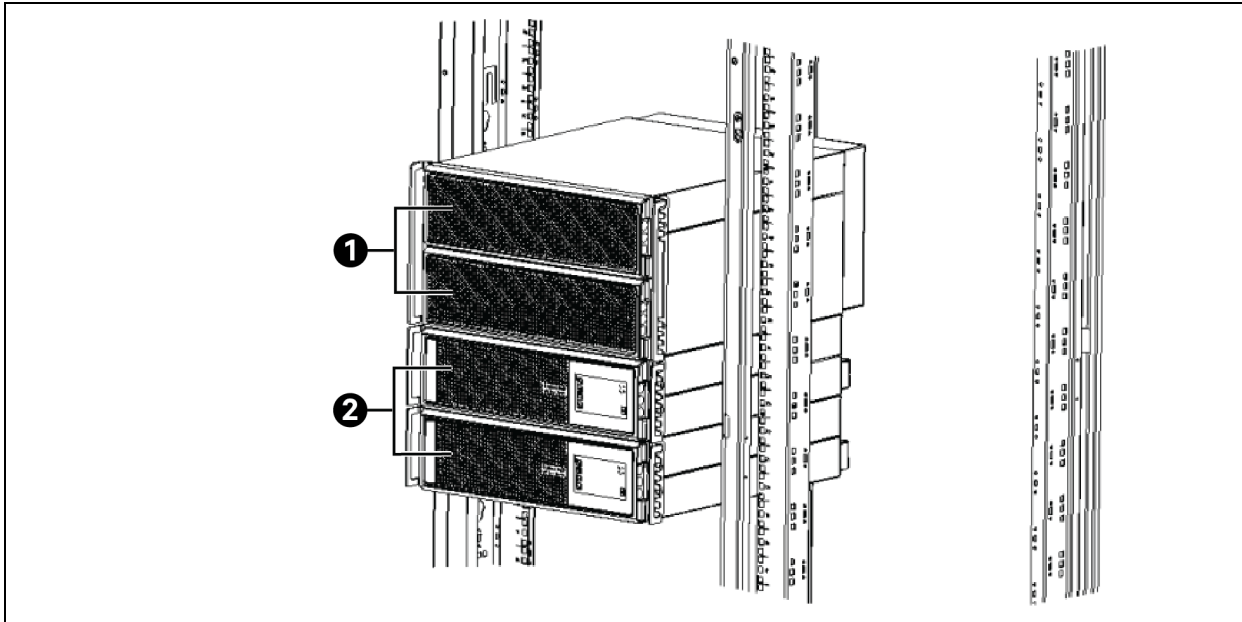

Item	Description
1	1+1 Parallel POD
2	UPS (2PCs)

4.4 Connecting Power Cables

Each single UPS of the parallel system needs to configure the MCB and cables respectively, see [Connecting Power Cables](#) on page 30 for the specification. The recommended configurations of the total power cables are listed in **Table 4.1** below for the parallel system.

Table 4.1 Input/Output Cable CSA for the 40 kVA Parallel System [Unit: mm², Ambient Temperature: 25 °C (77 °F)]

Parallel UPS Number	3-In 3-Out			
	Single Input Cable for Parallel System	Single Output Cable for Parallel System	Total Neutral Line for Parallel System	Grounding Cable for Parallel System
2 units	50	50	50	50
3 units	95	95	95	95
4 units	120	120	120	120

4.4.1 Connecting I/O Cables

The power cables of the UPS are connected to the I/O terminal block of the rear panel of the UPS. For the layout of the I/O terminal block, see [Connecting Input/Output Cables](#) on page 32.

The power cables of the UPS are connected to the I/O terminal block of the rear panel of the UPS. For the layout of the I/O terminal block, see **Figure 3.15** on page 34.

Power Distribution Mode

There are two modes for UPS parallel power distribution: using the 1+1 parallel POD (optional) provided by Vertiv, self-distribution.

The power distribution mode of the parallel system is the same as that of the single unit. For more information, see [Connecting Input/Output Cables](#) on page 32.

- Using parallel POD power distribution
It is recommended to use 1+1 parallel POD power distribution mode if you need 1+1 parallel system, see [Mechanical Installation](#) on the previous page for details. For more information on the installation and commissioning of different models, refer to **Vertiv™ Liebert® ITA2 30 kVA UPS Power Output Distribution Unit User Manual**.
- Self-distribution for the parallel system

When the UPS number of the parallel system is more than two, use self-distribution mode.

The block diagram of three UPSs parallel system is shown in **Figure 4.2** below. See Power distribution mode in [Connecting Input/Output Cables](#) on page 32 for the cable connection of each UPS. See [Connecting Power Cables](#) on page 30 for the input and output MCB, the battery MCB and the cables when using the self-distribution mode.

Figure 4.2 Block Diagram of Three UPSs Parallel System

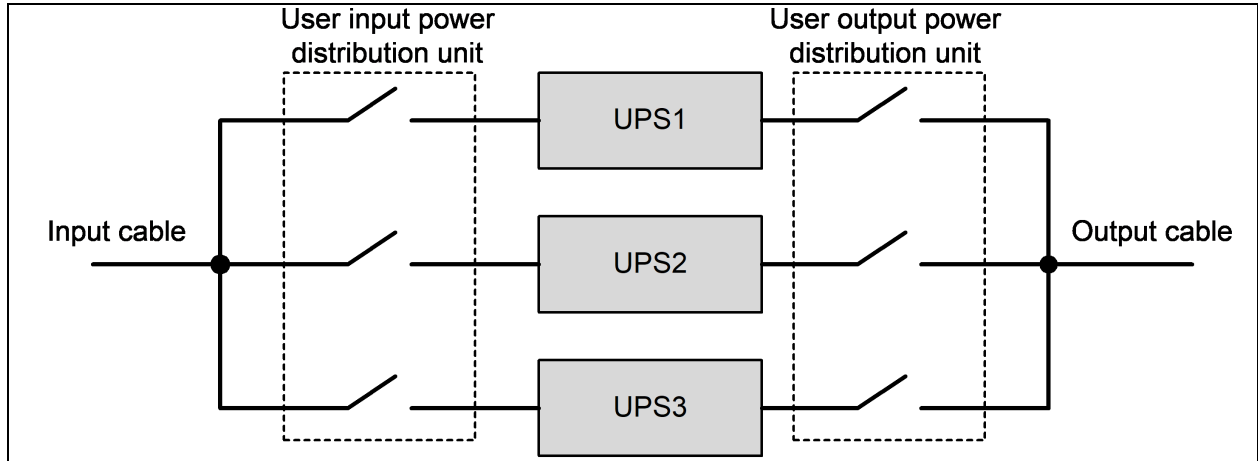

! **WARNING!** Configure each UPS with external input MCB and external output MCB when carrying out the power distribution for the parallel system, as shown in **Figure 4.2** above.

NOTE: After connecting power cables, the protective cover of the I/O terminal block must be reinstalled to avoid electric shock.

4.4.2 Connecting Parallel Cables

The parallel system provides parallel cable option. The parallel cables form a ring connection through the parallel ports on the rear panel of the UPS. The cable connection schematic diagram of 3+1 parallel system is shown in **Figure 4.3** below.

Figure 4.3 Cable Connection Schematic Diagram of 3+1 Parallel System

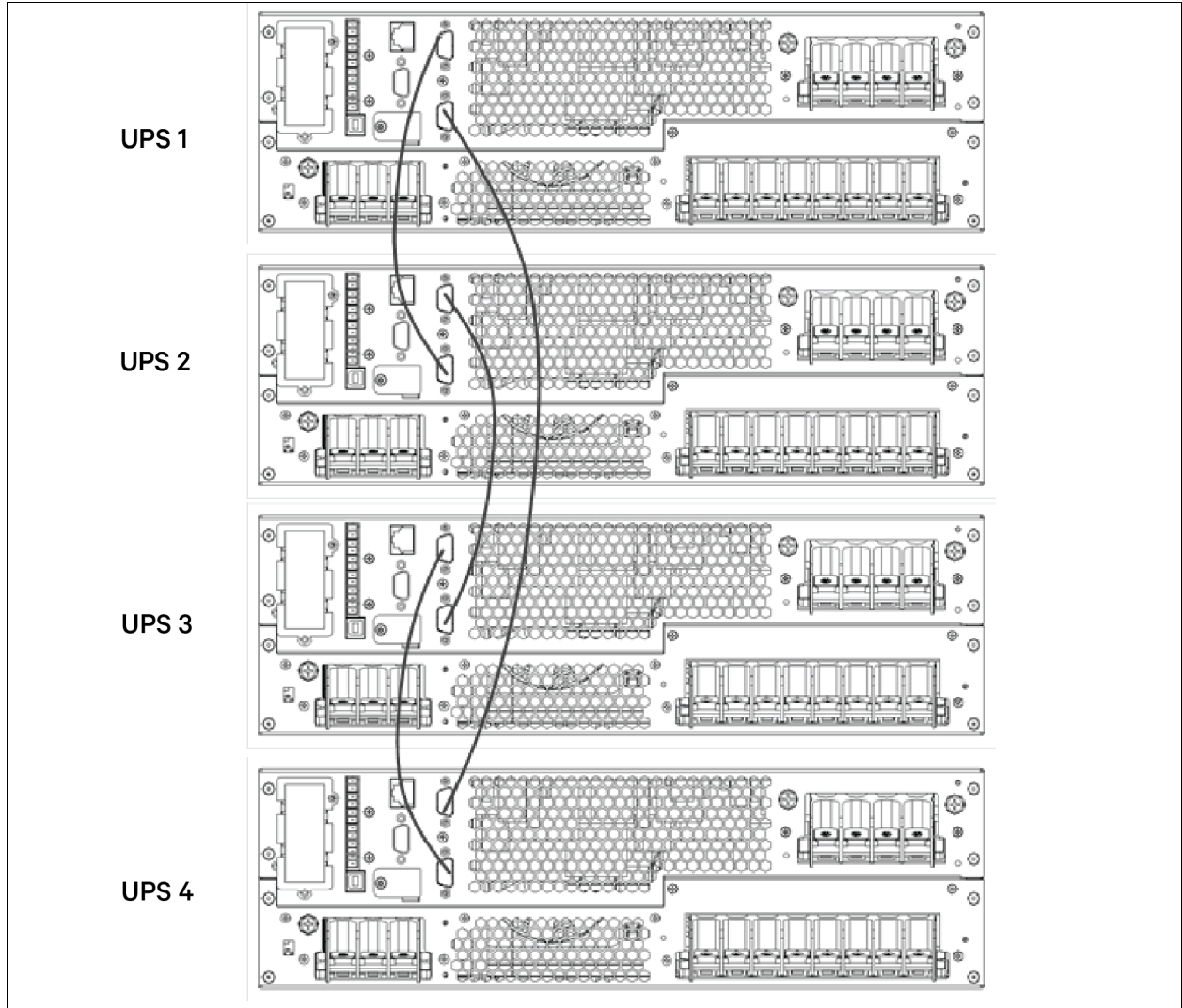

NOTE: The Vertiv parallel cables must be used for the parallel system.

NOTE: If the parallel communication fault occurs during the parallel commissioning or operation, just shut off the system and check whether the connection of the parallel cables is correct.

NOTE: During parallel system operation, do not unplug the parallel cables to avoid the risk of system damage.

4.4.3 Connecting Battery Cables

In the parallel system, the UPS can either share the battery strings or use the battery strings independently.

NOTE: Each UPS should be equipped with an independent battery MCB. Refer to **Table 3.4** on page 31 for selection of the battery MCB.

Using Battery String independently

When each UPS of the parallel system uses the battery string independently, the battery cables connection of each UPS in the parallel system is the same with that of the single UPS, see [Connecting Battery Cables](#) on page 34 for the installation method. The schematic diagram of battery strings in 1+1 parallel system with independent battery strings is shown in **Figure 4.4** below. See [Connecting Power Cables](#) on page 30 to configure an MCB.

NOTE: Make sure that the LCD settings are correct when using the battery strings independently for the parallel system, see [Parallel System Parameters Setting](#) on page 53 for details.

Figure 4.4 Connection Principle Diagram upon using Battery Strings Independently

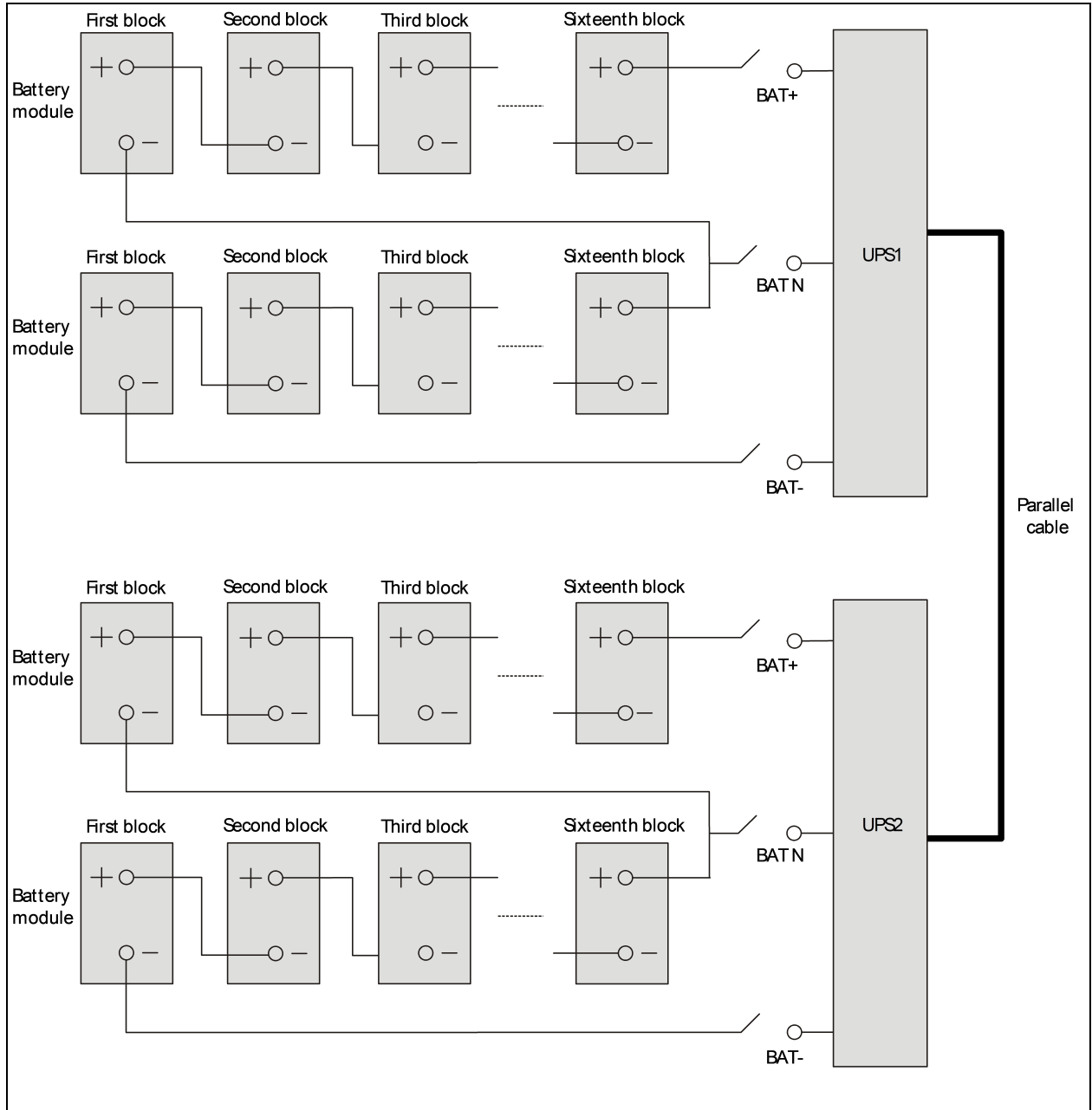

Sharing Battery Strings

Using the shared battery strings in the parallel system can save investment in equipment for the users.

NOTE: To ensure the abundant backup time of the battery, it is recommended to use the external battery cabinet with big capacity.

NOTE: The UPS shares the battery system, make sure that in each of the UPS enable share battery function. See [Setting Parameters of LBS on page 57](#).

Wiring

Power off the parallel system completely, disconnect the battery MCBs of all single UPSs, and then use battery cables see [Connecting Power Cables](#) on page 30 for the cables and the MCBs to connect '+' , 'N' , '-' and 'PE' terminals of the battery strings respectively to 'BAT+' , 'BAT-' , 'BAT N' and 'PE' terminals of the corresponding I/O terminal block of the UPS in the parallel system through each battery MCB, as shown in [Figure 4.5](#) below.

Figure 4.5 Connection Diagram of Shared Battery String in 1+1 Parallel System

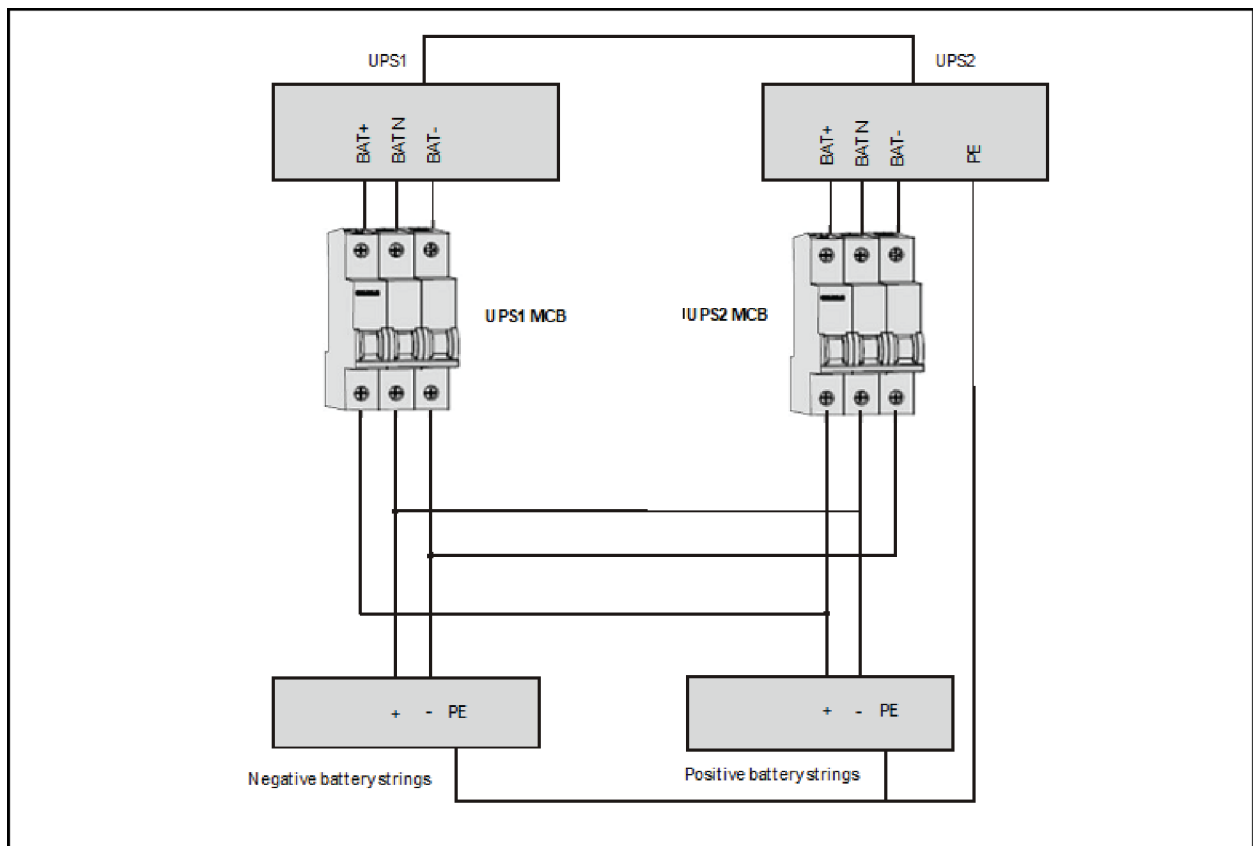

Refer to **Figure 4.6** below to configure the positive battery string and negative battery string.

Figure 4.6 Internal Connection Diagram for Positive Battery String and Negative Battery String

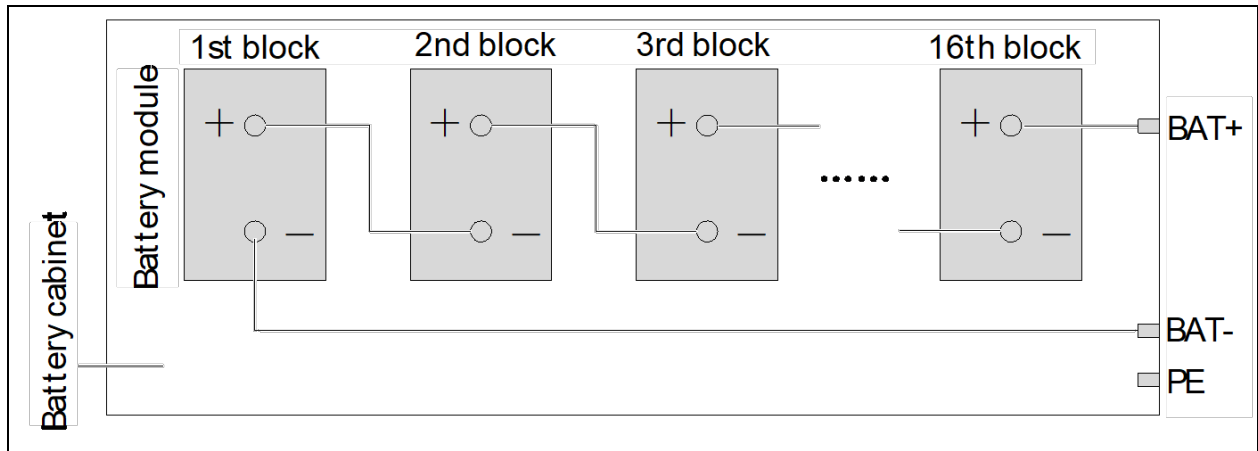

Close the *battery MCB* of each UPS.

4.5 Commissioning Parallel System

4.5.1 Check Before Startup

1. Check and ensure that power distribution mode of the UPS and the 1+1 parallel POD (if configured) is correct; those connections of the power cables and the signal cables are correct and there is no short circuit.
2. Check that the battery installation and cable connection is correct and there is no short circuit, and that the positive pole and negative pole of the battery are correct. Especially when each UPS of the parallel system shares the battery strings, check these items carefully.
3. Check all the working status of the parallel system, ensure that the phase sequence of the main, bypass and output of each UPS is correct and consistent, that the connection of the parallel cable is reliable, and that the user load is not connected during power-on.
4. Measure and ensure that the mains voltage and frequency are normal.
5. The output terminals of the UPS and the 1+1 parallel POD (if configured) are energized upon the startup. If the load is connected to the output terminals, make sure that the power to the load is safe.



WARNING! The output terminals of the UPS and the POD (if configured) will be live after starting on the UPS. When bypass of the single UPS in the parallel system is not consistent, the system fault may occur, check and ensure the bypass before power-on.

4.5.2 Parallel System Parameters Setting

The parallel parameters for all the UPS in the parallel system should be set. See **Figure 4.7** below.

Figure 4.7 Settings for Parallel Parameters

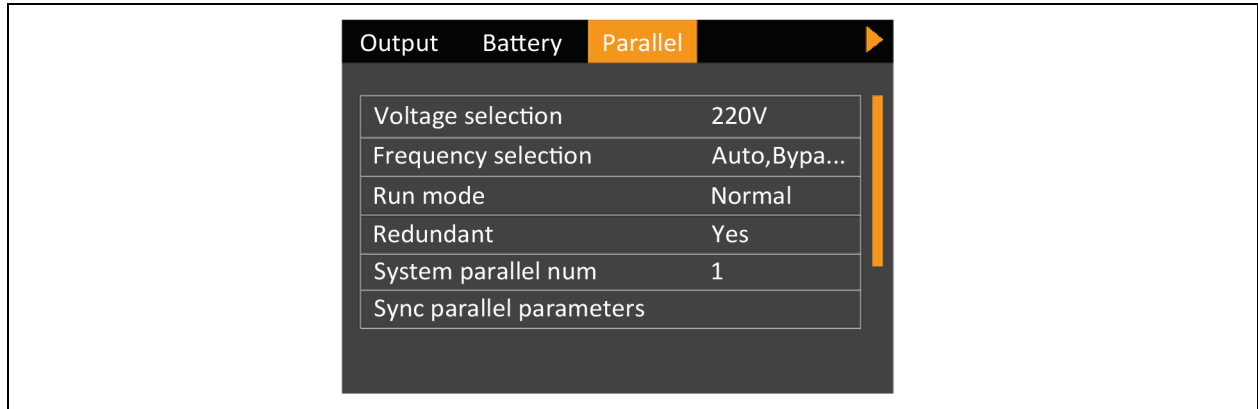

The user can change these settings according to actual needs see [LCD Parameters Setting](#) on page 117 for details. After the change, press the last item *Sync parallel parameters* to validate the setting.

4.5.3 Power on Commissioning for Parallel System

1. Set the parallel parameters of each UPS in the parallel system, then commission the inverter.

The specific commissioning procedures are as follows:

- a. Make sure that the output MCBs of all UPSs in the parallel system are open, and then close the external input MCB of each UPS in the parallel system, the UPS is powered on at the same time. If 1+1 parallel POD is configured, close the corresponding input MCB and bypass MCB. At the same time, close the corresponding output MCB of the other UPS which is being tested, and make sure that the corresponding output MCB of the other UPS is open.



WARNING! Electric shock. After the UPS external output MCB or POD output MCB is closed, the UPS output terminal block, POD output terminal block and load will be live, pay attention to personnel safety to avoid electric shock. Confirm whether it is safe to feed power to load.

NOTE: The LCD displays the self-check screen, and the alarm indicator (red) and run indicator (green) are on at the same time for about 5 seconds.

NOTE: After the rectifier has been in normal operation state for about 30 seconds, the rectifier start up is finished.

- b. See [Parallel System Parameters Setting](#) above for the parallel parameters setting for each UPS. Check whether there is an alarm of *Parallel comm. Fail*, if yes, clear the fault according to **Table 5.5** on page 76. Carry out the following procedures if the UPS is running normally.
- c. Press the power button of one UPS for 2 seconds, if 1+1 parallel POD is configured, press power button of the UPS which is being tested in the parallel system, then press Enter key to start the UPS. The run indicator (green) will blink, after the inverter is turned on, the run indicator will turn on, if 1+1 parallel POD is configured, the other UPS will display no redundancy in parallel, ignore the prompt at the moment.

NOTE: If the battery is not connected, the alarm indicator will be solid on, and the buzzer will beep every second. If the battery is connected, the alarm indicator will turn off.

- d. If the UPS is working normally, press the power button for 2 seconds to turn off the inverter.
- e. Repeat the preceding Step a to Step d to power on and commission the inverter of other UPS respectively.

NOTE: Carry out the parallel commissioning after each UPS is working normally.

2. After confirming that the inverter of each UPS is normal, commission the parallel system, the specific procedures are as follows:
 - a. Close the external output MCB and input MCB of each UPS, and all UPSs are powered on at the same time. After the start of the rectifier is finished, press the power button of one UPS for 2 seconds, the run indicator (green) will be on. Measure whether the inverter output voltage is normal. If the 1+1 parallel POD is configured, close the corresponding input MCB, bypass MCB and output MCB of the POD.
 - b. Start the inverter of the second UPS, check whether there is an alarm on the LCD, and confirm that the UPS parallel works normally.
 - c. Follow the methods to start inverter of the third or the fourth UPS to connect UPS into the parallel system.



WARNING! During the parallel power-on, confirm that the external output MCB of each UPS has been closed, and that all the inverter output of the UPSs are connected parallel. During the parallel power on, confirm that the system is working normally, and then feed power to the load, to void load power failure.

3. If the user needs to add one UPS in the parallel system, follow the commissioning procedures below:
 - a. Check and confirm that the power distribution mode, each power cable and signal cable of the added UPS are well connected without short circuit. Check that the battery installation and cables connection are correct without short circuit, and that the positive and negative are correct.
 - b. Repeat Step a to Step e in Part 1 to complete the single unit commissioning of the added UPS, before completely power off the UPS.
 - c. Ensure that the connection of power cable and signal cable is reliable.
 - d. Close the external input switch of the added UPS. After the system power on, find any online UPS, and enter the interface shown in **Figure 4.7** on the previous page. Set the system parallel No. from 'N' to 'N+1', then click the *Sync parallel parameters*.
 - e. Close the external output switch of the added UPS once again, normally start the inverter after the rectifier start up. Then check that the LCD has no alarm, and that the UPS parallel system works normally.

NOTE: For 1+1 parallel system, when one UPS is faulty and needs to be replaced on line, the above operation steps are available too. The difference is no need to change parallel No., just click the 'Sync parallel parameters' for the online UPS.

NOTE: Clicking the *Sync parallel parameters* to achieve the synchronization of the items in parallel settings interface, and the parameters will affect the parallel system. The user should manually set other parameters according to actual needs.

NOTE: When parallel system has output, *Sync parallel parameters* function can only be achieved via the UPS with output, otherwise this function is invalid.

NOTE: When adding a single unit in the parallel system, first ensure the parallel cables connection is correct, then power on the single unit.

4.6 Installation and Commissioning for Dual Bus System

4.6.1 Introduction

The dual bus system consists of two independent UPS systems; each UPS system consists of one single UPS.

The dual bus system has high reliability, which is suitable for the load with many input terminals. For single UPS input load, you can add a static trigger switch (STS, optional) to start the standard load bus synchronization (LBS) system.

Place all the UPS side by side, and connect them as following below instructions:

The dual bus system adopts the LBS system to realize the output synchronization of the two independent UPS systems. One is the primary system, and the other is the secondary system. The operation mode of the dual bus system contains primary system and/or secondary system running in Normal mode or Bypass mode. The schematic diagram of the LBS system built by two UPS is shown in **Figure 4.8** below.

Figure 4.8 LBS System Schematic Diagram

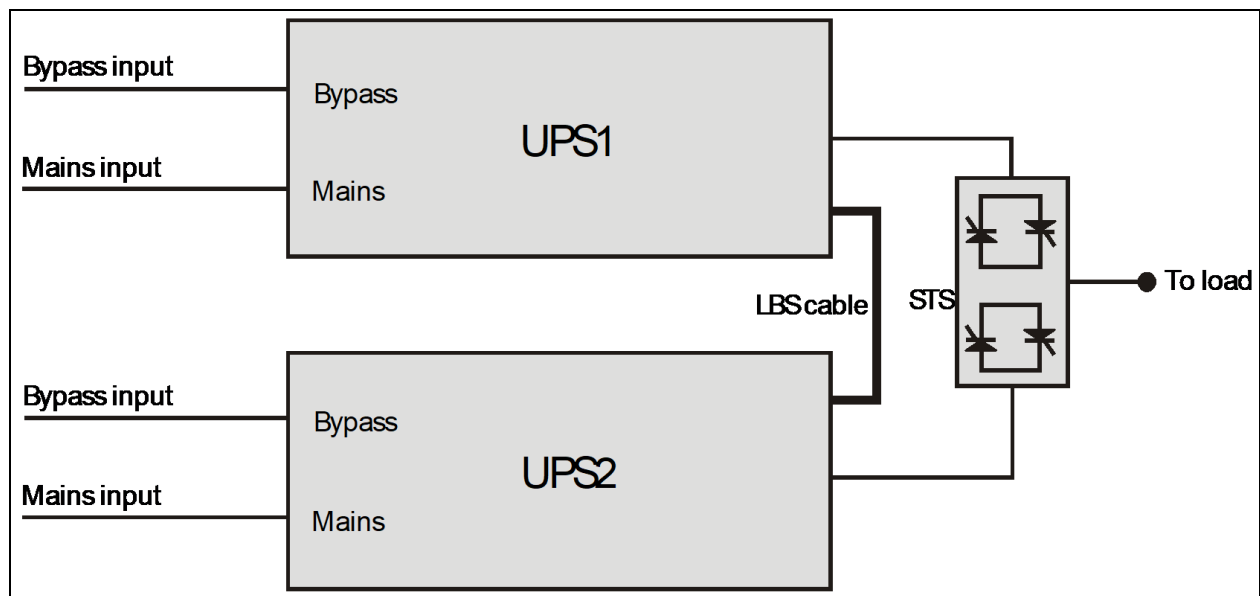

NOTE: UPS1 is primary system while UPS2 is secondary system.

NOTE: Refer to [Single UPS Commissioning](#) on page 40 respectively for the settings of the single UPS.

4.6.2 Installing External Protective Device

See [External Protective Devices](#) on page 22 for details of installation and type selection.

4.6.3 Connecting Power Cables

In dual bus system, refer to [Connecting Power Cables](#) on page 30 and [Connecting Power Cables](#) on page 47 to select the power cables for single UPS and parallel system respectively. The bypass input power and main input power must use the input terminal of the same neutral line. If the input terminal has leakage current, the leakage current protective device should be installed before the input terminal.

4.6.4 Connecting LBS Cables

NOTE: The appearance of the LBS port is the same as the parallel port see **Figure 2.3** on page 8.

NOTE: Paralleling of the UPS units is not applicable when the LBS function is used. Either paralleling or LBS function can be used at the same time.

NOTE: For the Dual bus system, it is recommended to use two LBS cables to connect between the two UPS Units for reliable connection.

Figure 4.9 LBS Cable Connection

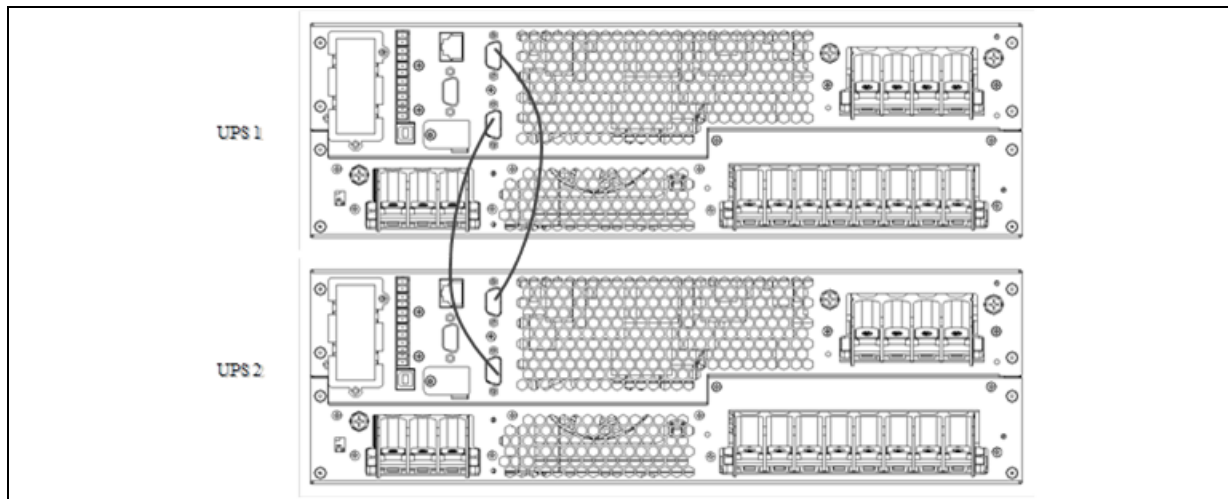

4.6.5 Setting Parameters of LBS

- The LBS parameters setting interface is shown in **Figure 4.10** below.
- Procedures for setting LBS parameters:
- Through the *Settings* -> *System* -> *LBS*, you can set the LBS according to actual needs.
- There are three items of LBS for selection: Disable, Secondary, Primary.

Figure 4.10 LBS Parameters Setting Interface

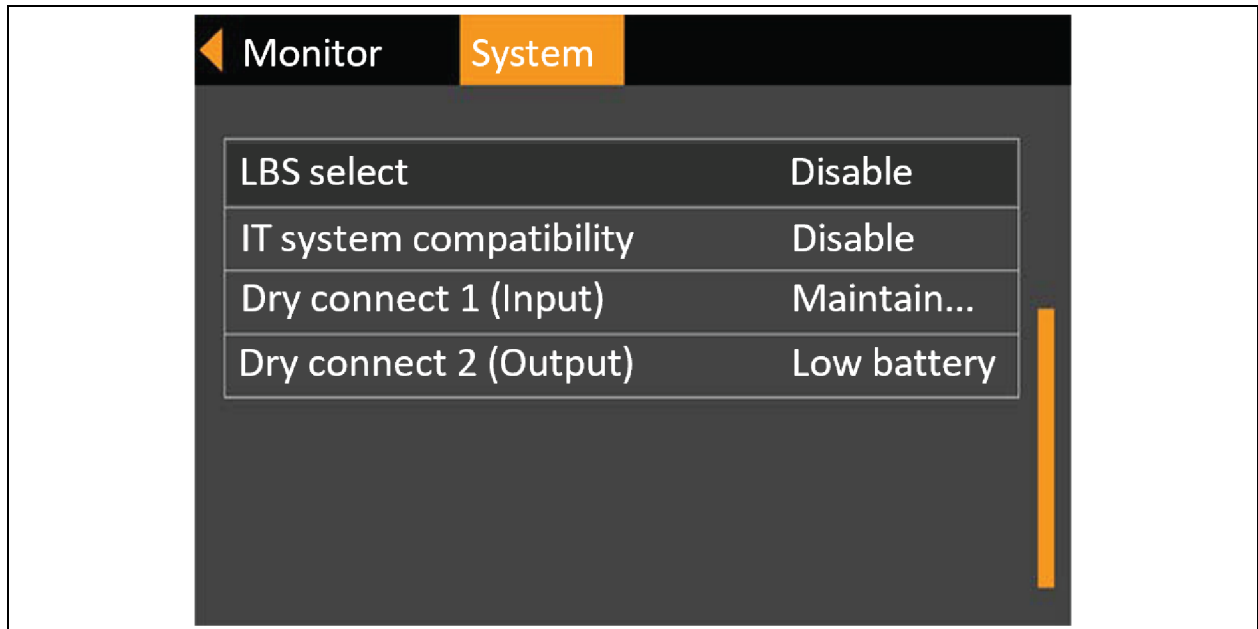

The LBS is the load synchronous system, which is used to implement the output voltage phase synchronization of the two sets of UPS system. Two sets of UPS system can only be two single UPS.

Manually set the Primary and Secondary through the LCD.

The UPS which is set to LBS primary can send synchronization signal to LBS secondary UPS according to the own inverter voltage phase. After the secondary UPS receives the synchronization signal sent by the primary UPS. The secondary UPS adjusts its inverter voltage phase to ensure synchronization with the primary UPS.

Through the above to realize the inverter voltage phase synchronization of two sets of UPS system, and realize the reliable transfer between the two sets of UPS output voltage and STS, then provide the reliable uninterrupted power supply to the load.

This page intentionally left blank

5 Operation and Display Panel

This chapter gives information about the functions and use of the components on the UPS operation and display panel, and provides LCD display information, including the;

- LCD screen types
- Detailed menu messages
- Prompt windows message and UPS alarm list

5.1 Introduction

The operation and display panel is located on the front panel of the UPS. Through the operation and display panel, conduct the operation and control of the UPS and check all the UPS parameters, UPS and battery states, and alarm message.

The operation and display panel provides LCD, menu keys, LED indicators (run indicator and alarm indicator), see **Figure 5.1** below.

Figure 5.1 Operation and Display Panel



Item	Description
1	Menu keys
2	LCD
3	Run indicator
4	Alarm indicator
5	Power button

NOTE: The device has a gravity sensor function, thus the LCD display direction will change according to the device layout mode.

5.1.1 LED Indicators

The LED indicators have the run indicator and alarm indicator. **Table 5.1** below gives the description of the indicators.

Table 5.1 Description of LED indicators

Indicator	Color	State	Meaning
Run indicator	Green	On	UPS has output
		Blinking	Inverter is starting
		Off	UPS has no output, inverter is starting
Alarm indicator	Yellow	On	Alarm occurs
	Red	On	Fault occurs
	/	Off	No alarm, no fault

5.1.2 Audible Alarm (Buzzer)

The UPS operation is available with the following two different kinds of audible alarms described in **Table 5.2** below.

Table 5.2 Description of Audible Alarm

Sound	Meaning
Continuous beep	When the UPS fault appears, such as fuse or hardware failure.
One beep every 0.5 second	When the UPS critical alarm appears, such as Inverter overload.
One beep every second	When the UPS critical alarm appears, such as battery low voltage.
One beep every 3.3 seconds	When the UPS general alarm appears.

5.1.3 LCD and Functional Keys

The operation and display panel provides five functional keys, the functions are described in **Table 5.3** below.

Table 5.3 Description of Control Buttons





Functional key	Silkprint	Description
Confirm		To confirm or enter
Up		To page up, turn left or add value, etc.
Down		To page down, turn right or reduce value, etc.
Escape		To get back, escape, cancel or forbid operation
Power		To power on, power off or transfer to bypass mode

Figure 5.2 LCD Screen



Item	Description
1	ECO Mode
2	Ambient temperature (Displays only when sensor connected)
3	Date and Time

The LCD has user friendly interface and the 320 × 240 dot matrix image display. The user friendly and menu driven LCD allows to easily browse through the UPS input, output, parameters of the load and the battery, learn about the current UPS status and alarm message, perform functional settings and control operation. The LCD also stores historical alarm records that can be retrieved for reference and diagnosis.

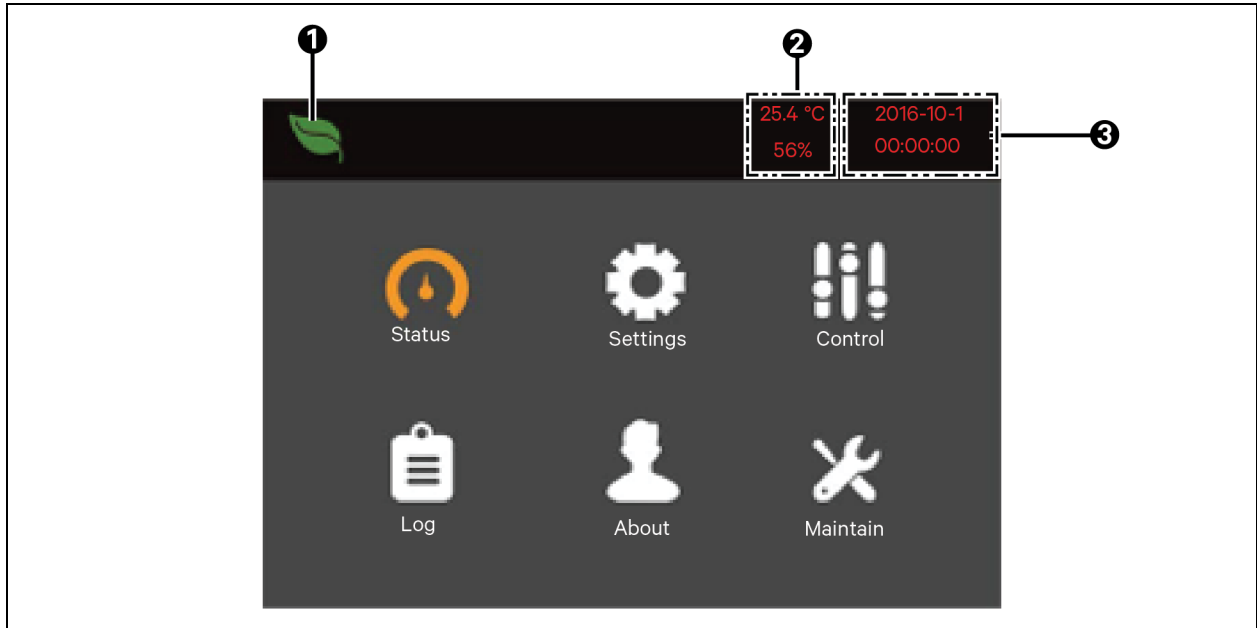
5.1.4 Initial Startup Guidance

When the UPS is in the initial startup, the interface shown in **Figure 5.3** below will appear to guide the user to set basic parameters of the UPS.

Figure 5.3 Initial Startup Guidance (1)

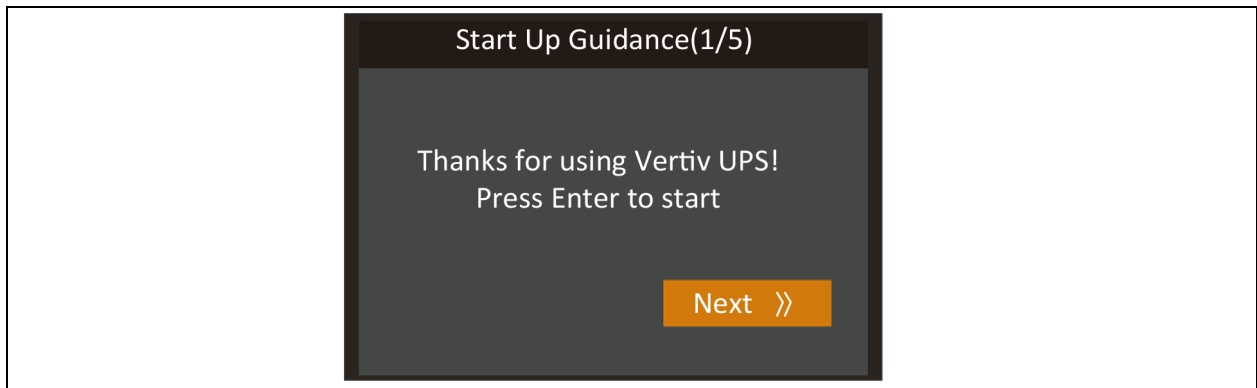

Welcome page

Click *Next* to start the guidance.

Language, date and time page

At this page, set the language, date, and time you need.

Figure 5.4 Initial Startup Guidance (2)

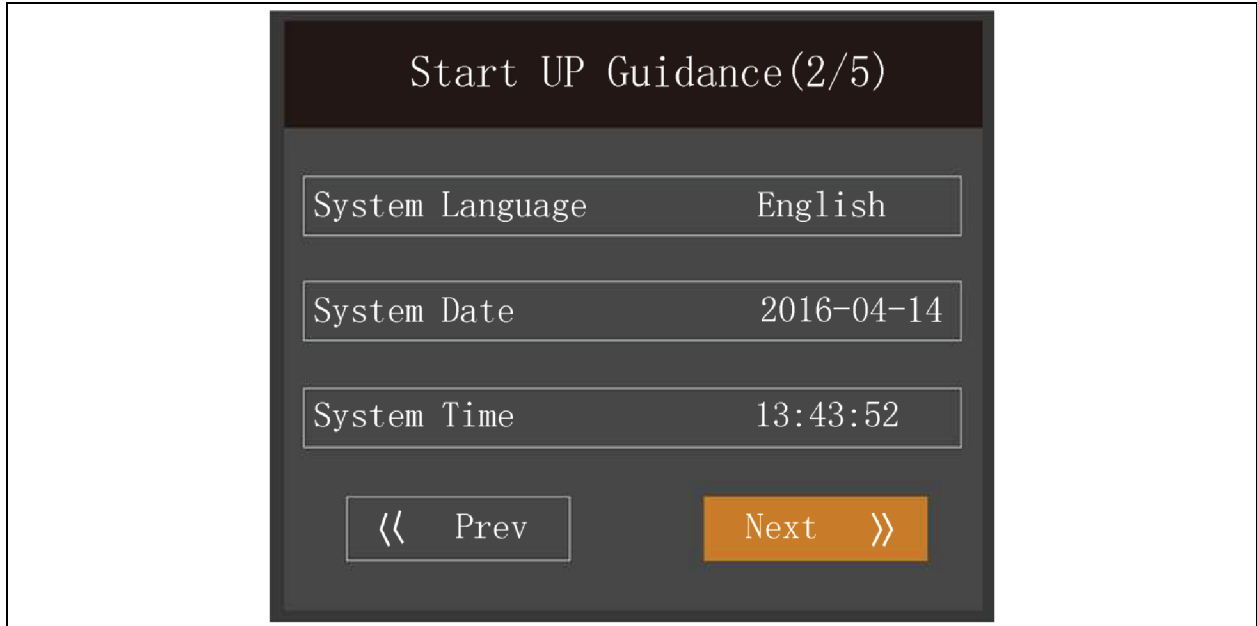

Battery Parameter Page

At this page, set the battery cell number and total Ah.

For 30 kVA model, the battery series are 32, 34, 36, 38 and 40 selectable. See **Figure 5.5** below.

Figure 5.5 Initial Startup Guidance (3)

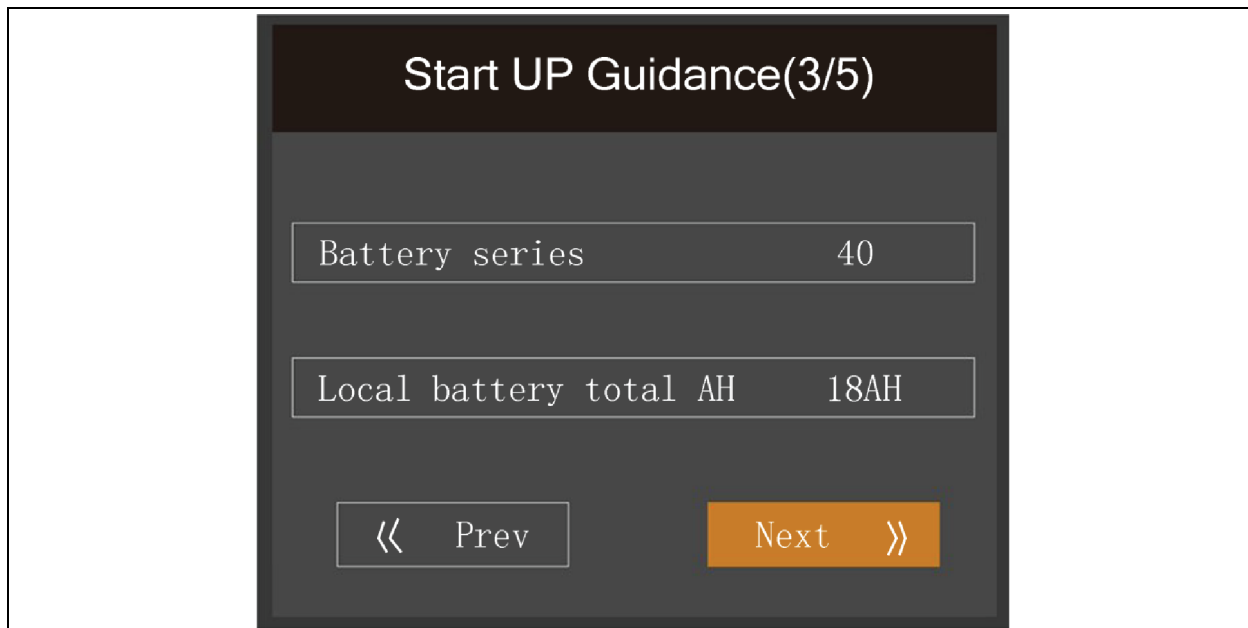

Output Page

As shown in **Figure 5.6** below, set output voltage, output frequency. The output voltage is detected automatically. If the result is displayed as *No*, the output voltage can be set manually.

Figure 5.6 Initial Startup Guidance (4)

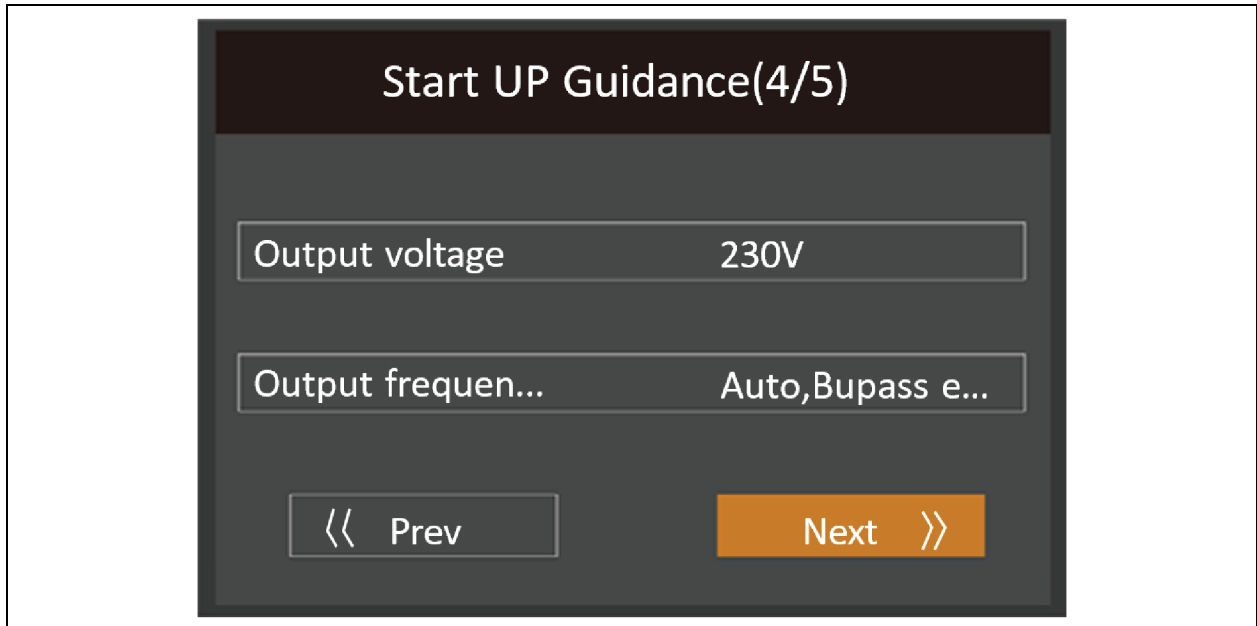

Finish Page

After the startup, the user can operate the UPS normally.

Figure 5.7 Initial Startup Guidance (5)

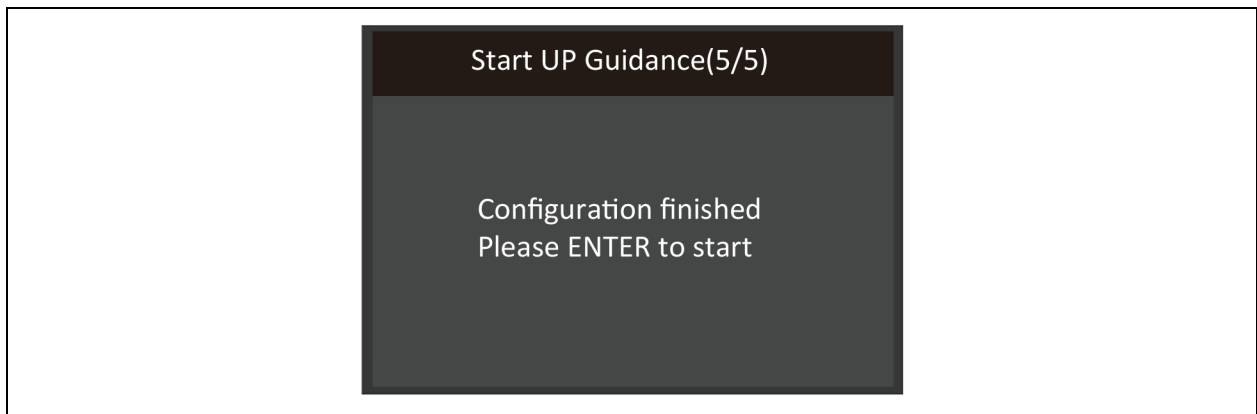

5.2 LCD Menu Structure

Figure 5.8 LCD Menu Structure

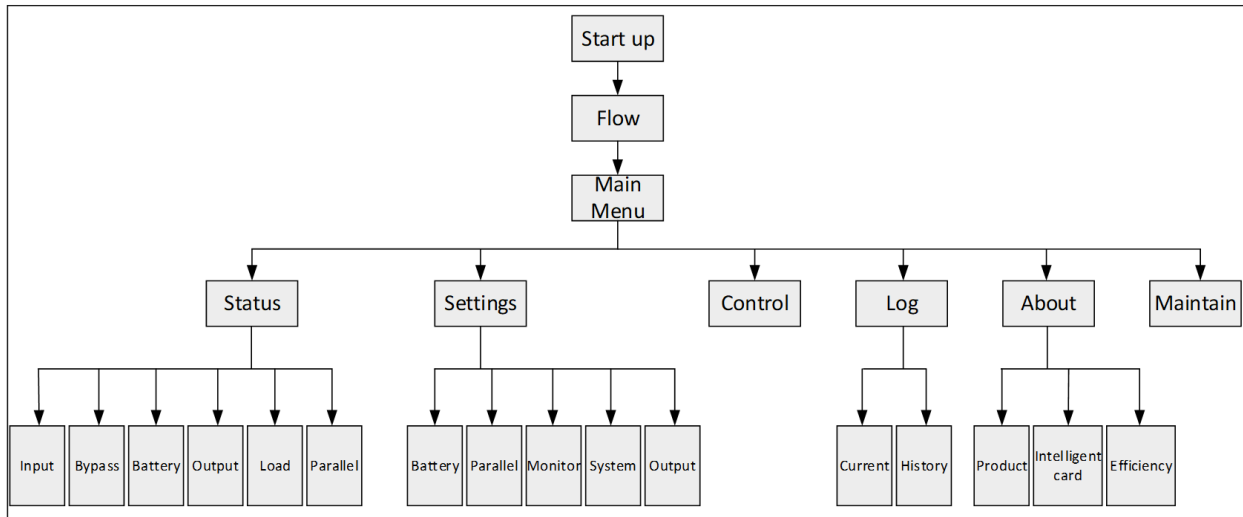

5.3 LCD Screen Types

5.3.1 Start Screen

Upon UPS startup, the UPS executes the system self-test, and the start screen will appear for about 10 seconds, as shown in Figure 5.9 below.

Figure 5.9 Start Screen



5.3.2 Flow Screen

After the self-test of the UPS, the flow screen shown in **Figure 5.10** below will appear.

The flow screen is the complete status view of the UPS, includes input, bypass, rectifier, battery, inverter and output, etc. The working modes with color display while the invalid modes with gray display.

Figure 5.10 Flow Screen

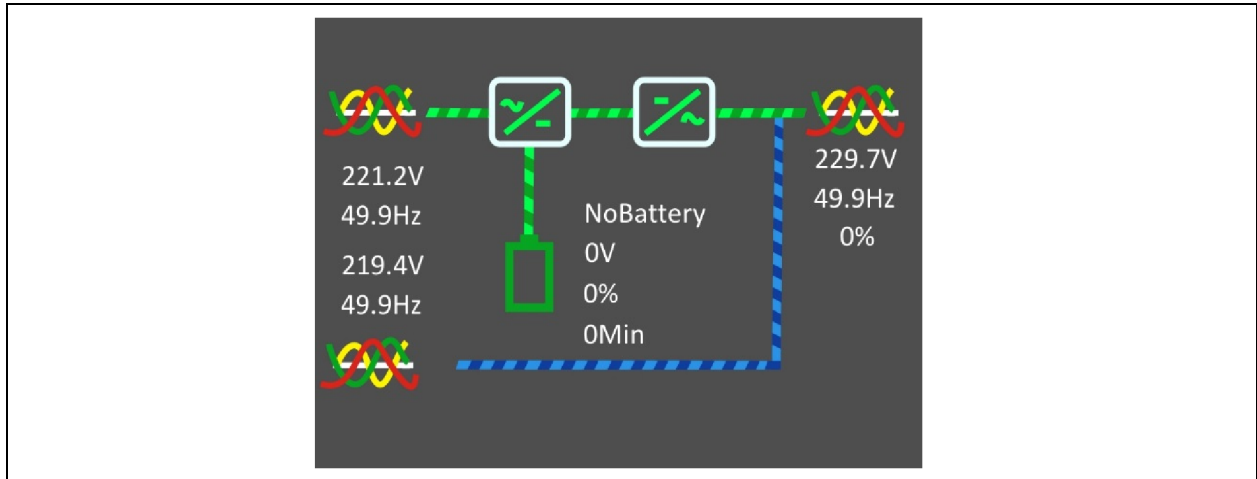

At the flow page, press the  key to enter the primary screen.





5.3.3 Main Menu Screen

The main menu screen has following six icons, see **Figure 5.11** below.

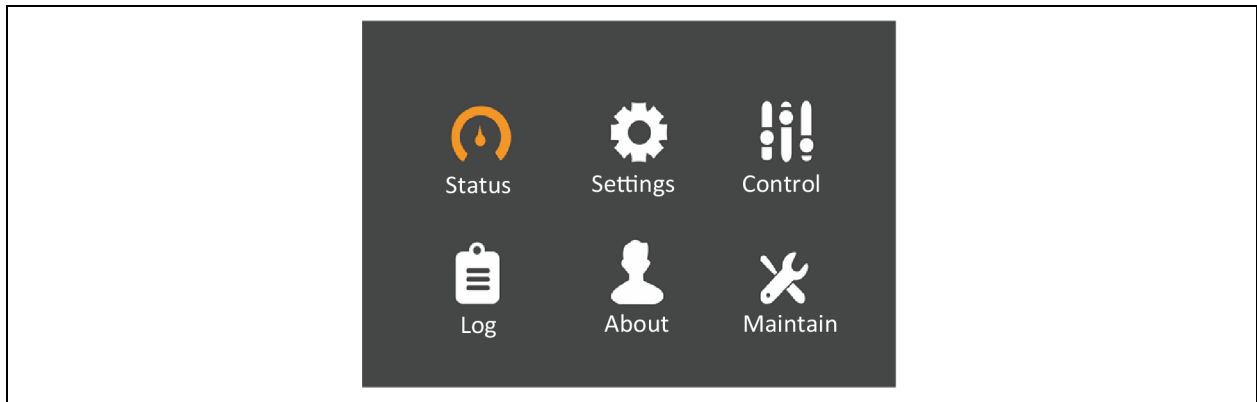



- Status
- Settings
- Control
- Log
- About
- Maintain

Figure 5.11 Main Menu Screen



At main menu screen, press the  key to get back to the flow screen. Press the  or  key to switch the cursor to select the submenu, then press the  key to confirm it.

5.3.4 Submenu Screen

- The submenu screen has the UPS parameters and item settings.
- In the submenu screen, if there is a tab control, just move the cursor to the tab. At this time, you can press the  or  key to switch the tab. Press the  key to move the cursor to a certain item.
- In the submenu screen, if there is no tab control, then the cursor will stop at a certain item.
- Press the  key to get back to the previous screen.
- For details about the submenu screen, see following pages.

Status Page

The Status page has the Input, Bypass, Battery, Output and Load as shown in **Figure 5.12** below.

Figure 5.12 Status Page

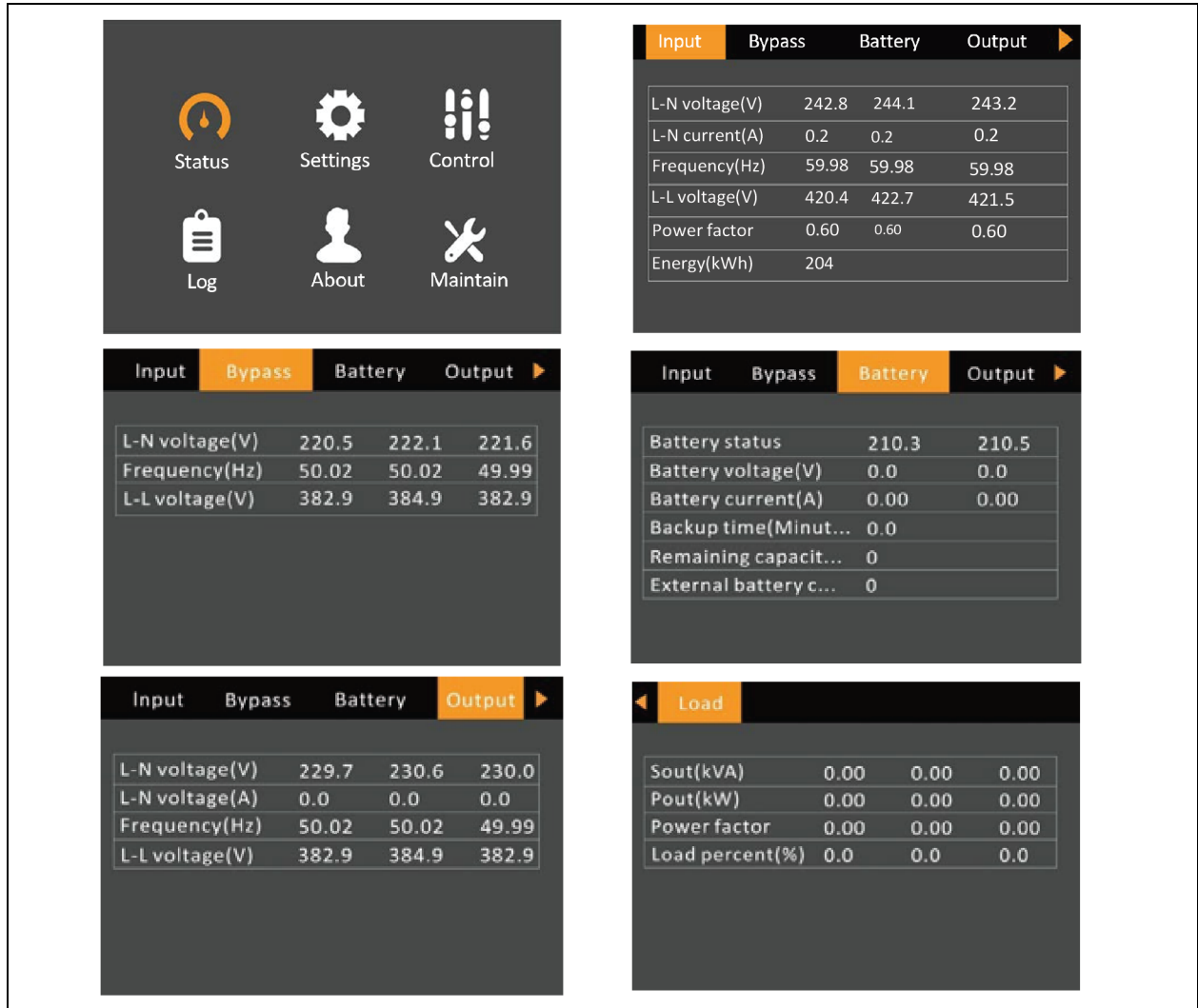

Settings Page

The Settings page has the Output, Battery, Parallel, Monitor, System, and Outlet. For details about the parameters setting, see [LCD Parameters Setting](#) on page 117.

Figure 5.13 Settings Page

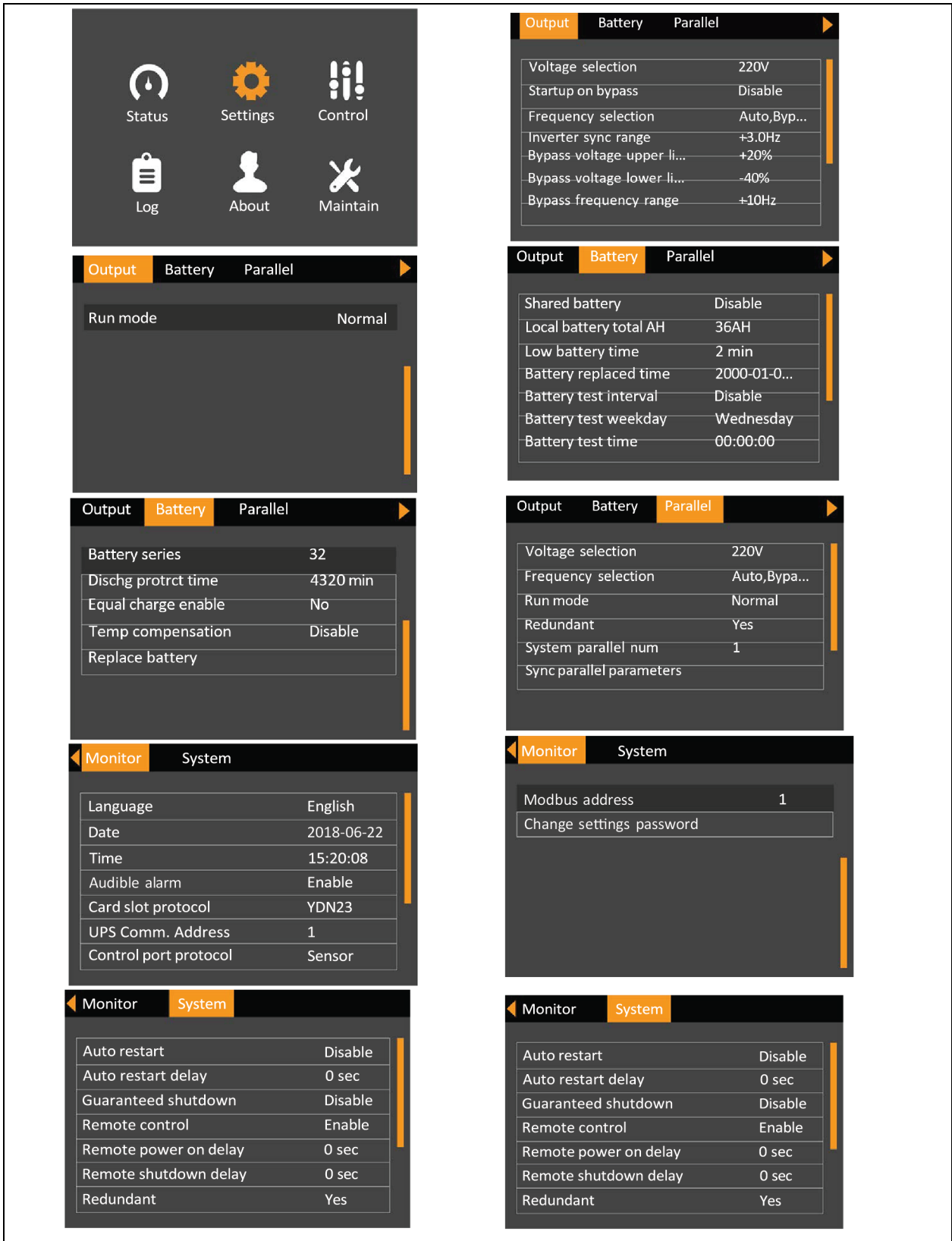

Control Page

The Control page has the Turn ON/OFF/to BYPASS, and Manual battery test, etc. See **Figure 5.14** below.

Figure 5.14 Control Page

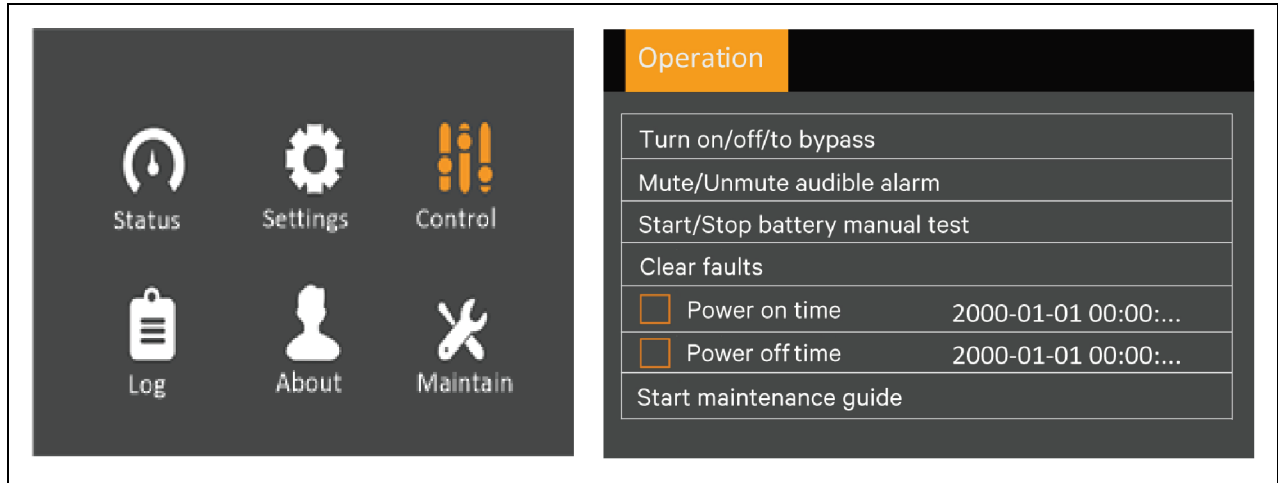

Log Page

The Log page has the Current and History. See **Figure 5.15** below.

Figure 5.15 Log Page

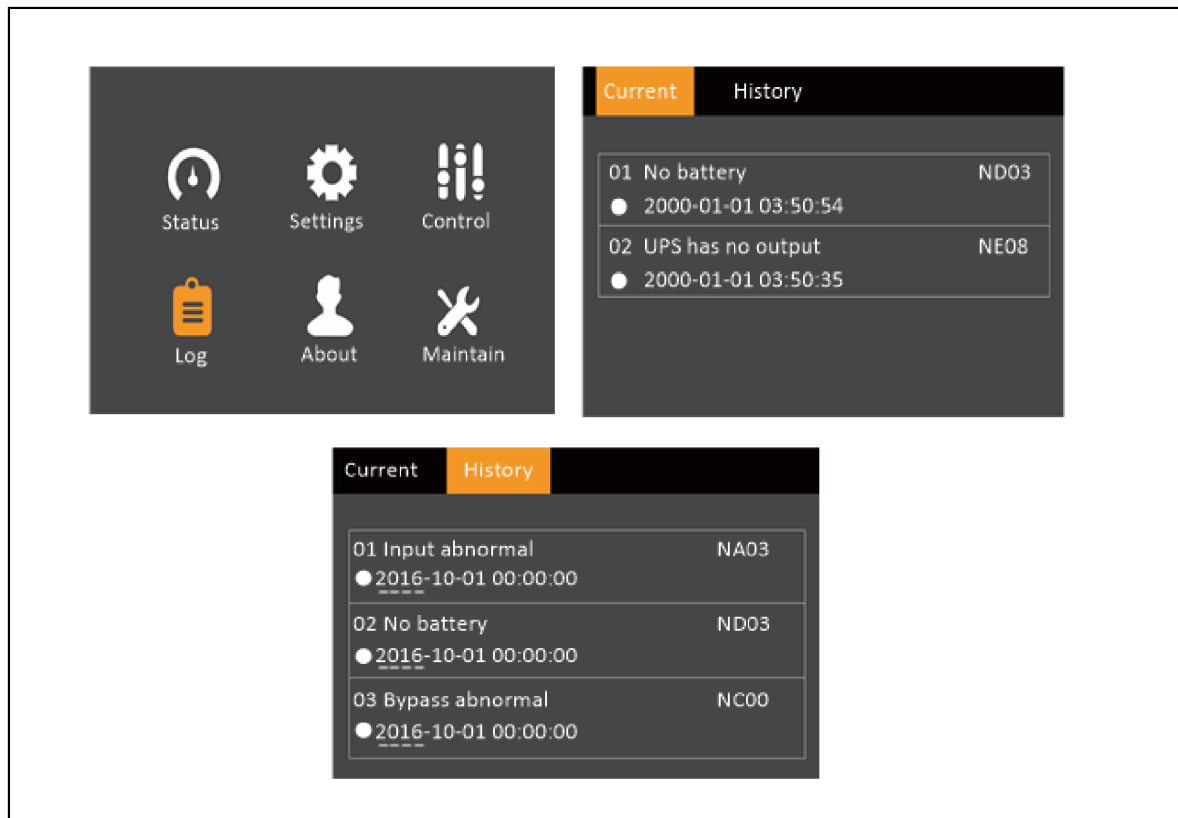

About Page

The About page has the Product, Network, and Efficiency. See **Figure 5.16** below.

Figure 5.16 About Page

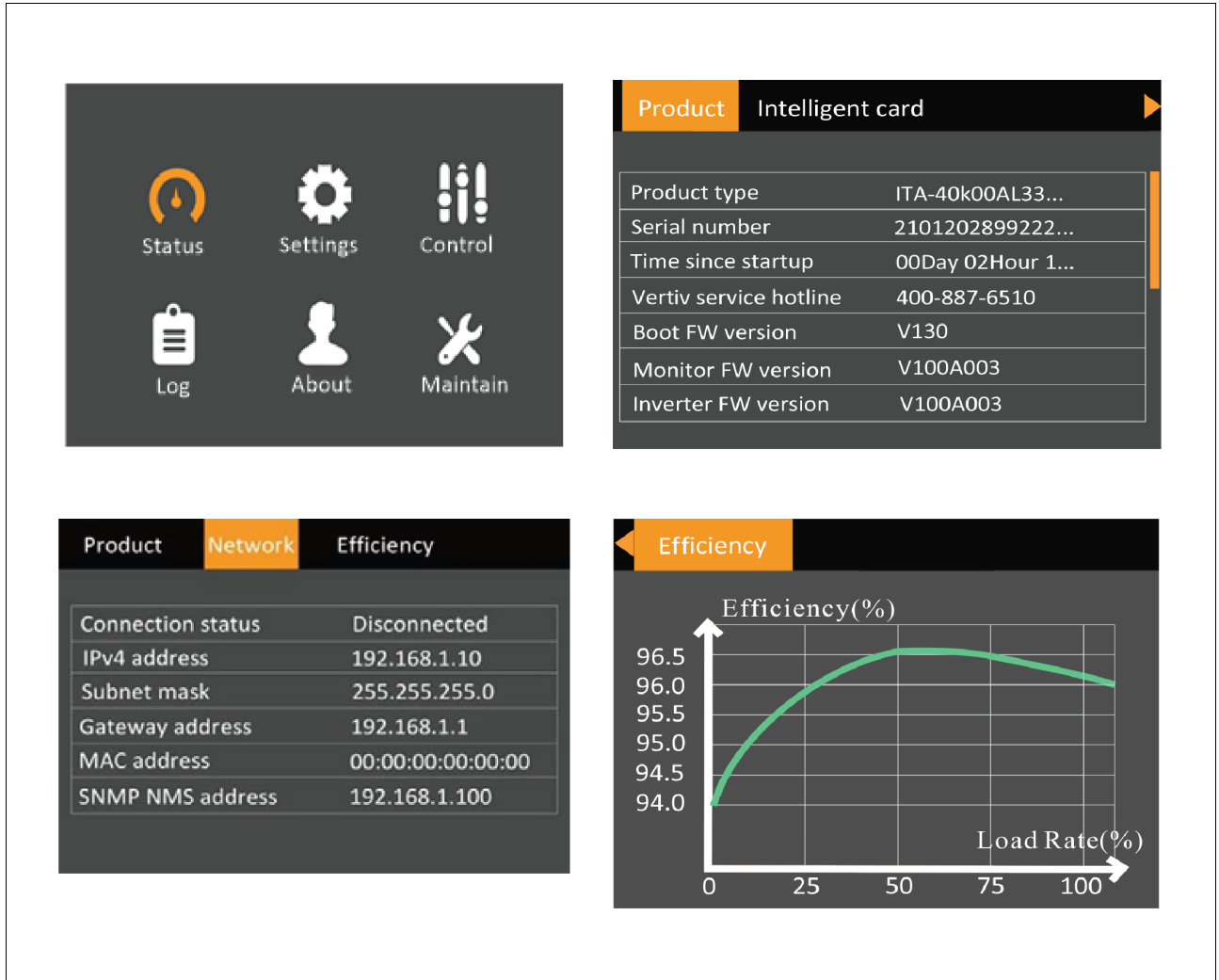

Maintain Page

NOTE: The Maintain page needs correct password and the Vertiv service engineer can only access the maintain page.

Figure 5.17 Maintain Page

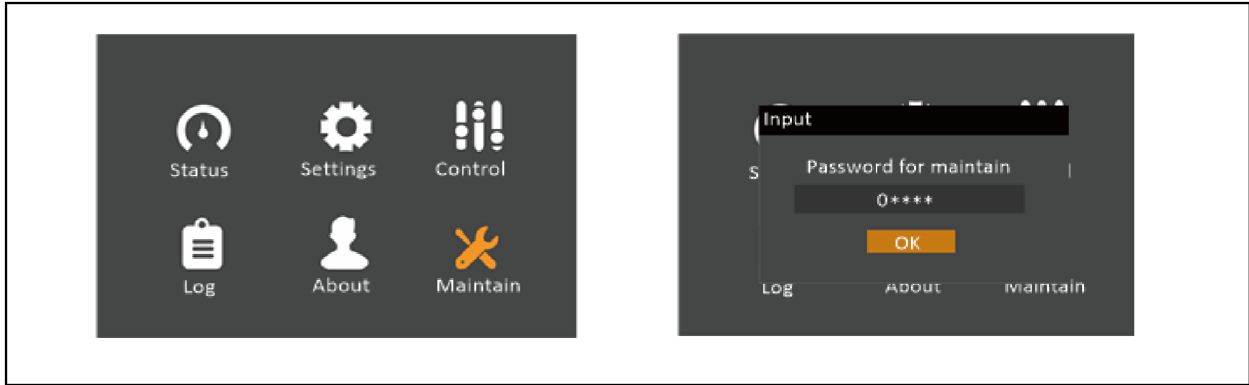

5.3.5 Default Screen

During the UPS operation, if there is no alarm within 2 minutes, the default screen shown in **Figure 5.18** below will appear. At the default screen, if there is an alarm or a fault, or the user press any key, the Flow screen will appear again.

Figure 5.18 Default Screen



5.4 Prompt Window

A prompt window is displayed during the operation of the system to alert about the conditions and/or if confirmation of a command or other operation is required. **Table 5.4** below lists the prompts and meanings.

Table 5.4 Prompts and Meanings

Prompt	Meaning
System setting is different, please check	When the parallel parameters are different, the prompt will appear.
Cannot set this online, please shut down output	If the user wants to change some important settings under condition of output (output voltage, output frequency, output phase No.), the prompt will appear.
Incorrect password, please input again	The prompt will appear when the incorrect password is entered.
Operation failed, condition is not met	The prompt will appear when the user wants to execute a certain operation but the condition is not met.
Password changed OK	The prompt will appear when the user successfully changes the password.
Fail to change password, please try again	The prompt will appear when the user tries to change the password but input two different new passwords.
The time cannot be earlier than system time	The prompt will appear when the user set the time of 'Turn on delay' or 'Turn off delay' is earlier than the current system time.
Turn on failed, condition is not met	When user press the power button (or execute the command of 'Turn on/Turn off/to Bypass' under 'Control' page), the prompt will appear.

5.5 UPS Alarm Message List

Table 5.5 below gives all UPS alarm messages of the Current and History menus.

Table 5.5 UPS Alarm Message List

Alarm message	Description
Communication fail	Internal communication is abnormal, check the communication cables are connected correctly or not.
Rectifier fault	The rectifier is faulty or it is off.
DC/DC fault	The output current is abnormal, because the bus voltage exceeds the setting range when discharger starts or soft starts.
DC bus abnormal	The inverter is off when DC bus voltage is faulty. The load will transfer to bypass if the bypass is available.
Charger fault	The charger output voltage is abnormal, and the charger is off.
Aux. power fault	The auxiliary power output voltage exceeds beyond the normal range.
Input backfeed	Battery mode. The mains relay short circuit, and the difference between mains and battery voltage is less than the setting range.
Inverter fault	The inverter is off when the inverter output voltage and current exceed the setting range. If bypass is available, the UPS will transfer to bypass mode, otherwise the system will power off.
Output short	Check that the output cables are not shorted.
Bypass backfeed	Battery mode. The bypass relay is shorted or the SCR is damaged.
Output off, voltage is not zero	When there is no output, the system detects that the output has a voltage.
Inverter relay welded	The inverter relay is shorted.
Parallel No. abnormal	The parallel online number is different from the setting number. Check that the parallel number at Settings page is the same as the actual online number, and that the parallel cables are normal.
Parallel comm fault	The local UPS and its online frequency configuration is different or the parallel address is conflicted. Check that the parallel system parameter setting is the same as the local parameter setting.
Parallel cable connection abnormal	Check if the parallel cables are loosened.
Input neutral lost	The AC input mains N line is not detected. Check that the input N line is opened or loosened.
Input ground lost	Check that the PE line is well connected, and the alarm is cleared online.
Input phase reversed	The mains AC input phase is reversed. Normally, phase B lags phase A of 120 degrees, and phase C lags phase B of 120 degrees. Check that the UPS mains input phase sequence is correct. If not, modify it.
Input abnormal	The rectifier and charger are off because the mains voltage and frequency exceeding normal range. Check that the rectifier input phase voltage and frequency exceed the normal range or that the mains has power-off.
Rectifier overload	The output power is larger than the rectifier overload point. Check that the input voltage meets the output load, mains input 176 V to 100 V, the load 100% to 50% linear derating.
Battery reversed	The positive and negative terminals of the battery are reversed. Connect the battery terminals again correctly.
Battery low pre-warning	This alarm occurs when the battery reaches the EOD. After the pre-warning, the battery capacity allows 2 minutes output at full load. The user can set the time ranging from 2 minutes to 30 minutes, (2 minutes by default). Shut down the load timely.

Table 5.5 UPS Alarm Message List (continued)

Alarm message	Description
Battery voltage abnormal	When battery is connected, the system checks that the battery voltage exceeds the normal setting range. Check whether the battery terminal voltage exceeds the normal range.
No battery	Check the battery and battery cables connection.
Battery series not qualified	The actual connected battery cells are different from the setting cells. Change to the same.
Battery aged	The battery capacity is less than 25% of the initial capacity. Battery replacement is recommended.
Battery test fail	The low voltage of the battery is detected when the battery has manual or periodical self-test. Battery replacement is recommended.
Battery overtemp	Battery ambient temperature is too high. Check that the battery ambient temperature is higher than setting value 40 °C to 60 °C (104 °F to 140 °F). The default value is 50 °C (122 °F).
Battery cabinet not connected	The battery cabinet is not connected to the system.
Fan fault	At least one fan is faulty. Check that the fan is blocked or the cables connection is loosened.
System overtemp	Internal heat sink temperature is too high, and the inverter is off. When each module heat sink temperature is decreased to the setting value the alarm can be muted. The system automatically starts after the overtemperature fault is solved. If overtemperature state is reached, check the following: <ol style="list-style-type: none"> 1. Ambient temperature too high or not. 2. Dust is blocked or not. 3. Fan fault occurred or not.
Inverter overload	Inverter load capacity is larger than the rated value, overload delay time is up, inverter shuts down. If bypass is available, the system will transfer to the bypass mode, otherwise the output fails. Check that the actual inverter load capacity, if overloaded, just reduce the load capacity, and the system will transfer to the inverter mode after 5 minutes and the alarm will stop.
Bypass phase reversed	The bypass voltage phase sequence is reversed. Normally, phase B lags phase A of 120 degrees, and phase C lags phase B of 120 degrees. Check that the UPS bypass input phase sequence is correct. If not, modify it.
Bypass overcurrent	The bypass current exceeds beyond the rated value. Overload delay time is up, inverter shuts down.
Parallel bypass cable connection abnormal	The bypass phase number is different from the output phase number under 'Monitor'. Check that the bypass cables connection is the same as the configured phase number.
Bypass abnormal	The bypass voltage and frequency are out of the range, bypass power-off and incorrect bypass cables connection. <ol style="list-style-type: none"> 1. Check that the bypass voltage and frequency are within the setting range. 2. Check the bypass cables connection.
Bypass abnormal in ECO mode	The ECO mode is available, and the bypass voltage and frequency are out of the setting range. Check that the bypass input voltage and frequency are within the setting range.
Input neutral-ground abnormal	The output and enclosure are shorted. Check whether the output cable connections and the enclosure are shorted or not.
Output pending	Triggering shutdown dry contact signal at any mode and system has output ,or triggering shutdown dry contact signal in battery mode. Check that the shutdown dry contact signal in battery mode or any mode is triggered, if not, check the X1 board.
Output voltage abnormal	The internal output disconnects. Check output fuse and relays.

Table 5.5 UPS Alarm Message List (continued)

Alarm message	Description
Output disabled	The system is in standby state, and the dry contact shutdown is enabled. Check whether the shutdown dry contact is enabled or not.
Version incompatible	The version between monitoring board and DSP board is incompatible.
Input neutral-ground abnormal	Short circuit between bus and enclosure or between battery and enclosure. Check whether the bus and battery cables connection are shorted with the enclosure or not.
On maintenance bypass	The dry contact in maintenance bypass state is activated.
Battery mode	The UPS is operating on battery, and the inverter starts.
Bypass mode	The UPS is operating on bypass.
System overload	The parallel system load capacity is larger than the max. load capacity obtained by parallel sets. Confirm the parallel system load capacity, if overloaded, just reduce it.
Loss of redundancy	After the parallel redundancy is enabled, the system load capacity is larger than the rated load of (online set minus one).
Load sharing abnormal	Load sharing is abnormal in parallel system.
System parallel settings async	Check that parallel setting parameters of each unit are the same.
Local parallel settings async	Check that the Settings page is the same between this local unit and other units.
LBS abnormal	Check whether the LBS cables are normal, the system is in stand-by state, or system on bypass and the bypass unable to trace.
REPO	Shutdown caused by the REPO terminal Normally Closed contact open.
Bypass phase reversed	During parallel connection, the bypass phase sequence is not the same. Check the parallel bypass cables connection.
System battery low pre-warning	In parallel system, all the devices powered by the battery inverter have low voltage battery pre-warning.
Battery test started	The battery periodical self-test and manual self-test started.
Battery test stopped	The battery periodical self-test or manual self-test finished.
EOD turn off	The inverter is off due to EOD. Check the mains power-off state and recover the mains in time.
Guaranteed shutdown	Under forced EOD mode, the battery discharging finished, then system shuts down.
Shutdown due to overtemp	During the UPS operation, the system checks that the heat sink temperature exceeds beyond the setting range. If overtemperature, check the following: <ol style="list-style-type: none"> 1. Ambient temperature too high or not. 2. Dust is blocked or not. 3. Fan fault or not.
Remote shutdown	Dry contact activated at any mode shutdown.

Table 5.5 UPS Alarm Message List (continued)

Alarm message	Description
Remote power-on	Remotely power on.
Remote shut-off	Remotely power off.
Load off due to shutdown on battery	Shutdown in battery mode.
Output off due to bypass abnormal	The bypass is abnormal, and the bypass is in standby state from operating state. Check that the bypass input is normal.
Battery to utility transition	The UPS is powered by the mains instead of the battery.
Manual power-on	Set power-on via LCD panel.
Manual shutdown	Set shutdown via LCD panel.
Operating on inverter	The UPS output state is on inverter.
Battery series set to 32 (24 to 40)	The battery cells are changed.
Restore factory defaults	Under UPS standby state, set 'Restore Factory Defaults' function via the Maintain page.
UPS is out of service	The UPS is out of service.
System parallel settings start sync	Manually set the 'Sync parallel parameters' command to activate the event.
Local settings sync OK	Local parameters are successfully synchronized.
System settings sync OK	All the parameters are successfully synchronized.
Load off due to output short	The inverter short circuit or the bypass short circuit. Check the connections.
Output off due to overload & bypass abnormal	The output is off due to output overload and bypass abnormal. Check the connections.
Parallel No. abnormal	The parallel online number and the configured number are different. Check that the parallel number under Setting page is the same as the actual online number, and that the parallel cables are normal.
Bypass disabled	In Settings -> Output -> Frequency selection, 'Auto, BypDisa; 50Hz, BypDisa; 60Hz, BypDisa' is set, the LCD will generate BypDisa alarm.
On intelligent sleep mode	After the intelligent sleep mode is enabled, the system has N sets of inverter startup. When the system meets the sleep requirement (Condition of entering sleep mode: Shared large battery string (If no large battery string, the sleep mode will cause the battery charging failure, host sleep enable, inverter side no fault or alarm, rectifier side no fault or alarm, with battery but large battery no charging need, rectifier not on battery mode, wait for 1h after exiting the former sleep, not master and the local unit ID number except sleep module has no startup command within 5 minutes). When the N minus 2 units' rated load is larger than the existing system rated load capacity, the unit with the largest ID number starts to enter sleep mode (inverter off), at this time, the N minus 1 units are working in inverter mode. The N minus 3 units are larger than the current system rated load capacity, and the unit with the largest ID number keeps sleep mode.

Table 5.5 UPS Alarm Message List (continued)

Alarm message	Description
Battery EOD	Battery end of discharge.
Faults cleared	Press the 'Clear faults' button under 'Control', then the system will record this event.
Manual shut off	After the user shuts the UPS output, then the system will record this event.
System warning	In parallel system, the alarm occurs when UPS's self-adapting output frequency is inconsistent. Solution: Power on again.
System fault	The alarm occurs when model identification is incorrect. Solution: Contact service manager.

NOTE: If the alarm rings because of the setting of the software value, which is done by the Vertiv authorized engineer, to change the software setting values, contact to the Vertiv local customer service center.

6 UPS Operation Instructions

This chapter gives a detailed description of the UPS operation procedures.

During the operation, the buzzer alarm may ring, at this point, When the alarm rings press  the key for 3 seconds to silent the alarm.



WARNING! Hazardous mains and/or battery voltage exists behind the protective cover. No user accessible parts are located behind the protective covers that require a tool for removal. Only qualified service personnel are authorized to remove such covers. If maintenance for rack is needed, ensure that the neutral line is live.

6.1 UPS Startup

The startup procedure is performed after the installation is completed, the system is commissioned by authorized engineer and the external input MCBs are closed.



WARNING! In startup procedure the mains voltage is applied to the UPS output terminals. Ensure that the load power is safe, if there is a load to be connected with the UPS output terminal. Ensure that the load is isolated with the UPS output terminal, if the load is not ready for accepting the power.

The startup mode of the single UPS includes normal mode startup and battery mode start up. For more information, see [Normal Mode Startup](#) on page 41 and [Battery Mode Startup](#) on page 43.

6.2 Transfer Procedures between Operation Modes

NOTE: The Inverter operation mode includes Normal mode (mains inverter) and Battery mode (battery inverter).

6.2.1 Transfer from Normal Mode to Battery Mode

In case of mains failure, the UPS will transfer to Battery mode. If you wish to transfer the UPS from Battery mode to Normal mode, wait few seconds for mains input recovery. 10 seconds later, the rectifier will restart automatically, and the inverter will restore the power.

6.2.2 Transfer from Inverter Mode to Bypass Mode

In standby mode, press and hold the power button. If the rectifier and inverter are normal, the interface shown in **Figure 6.1** below will appear, select YES to turn on the UPS.

Figure 6.1 Turning ON UPS

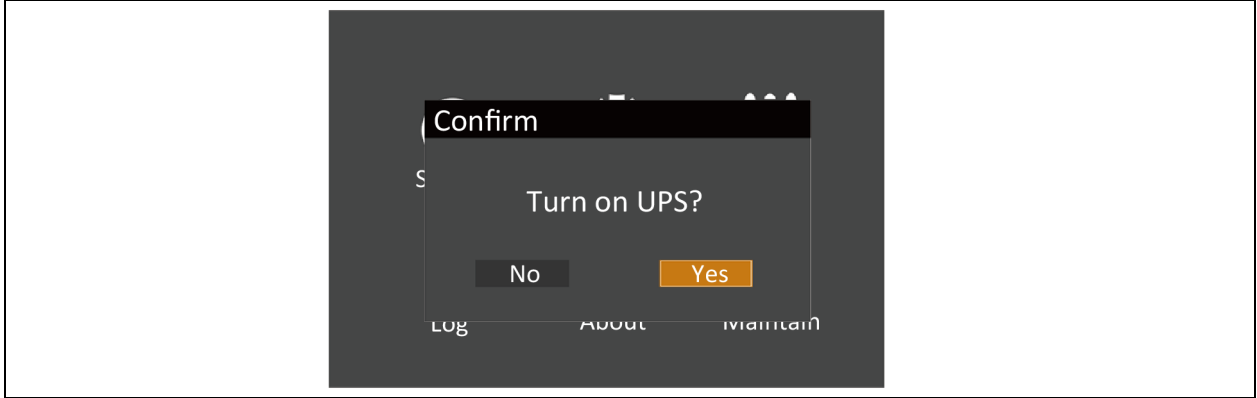

In Inverter mode, press and hold the power button. If the bypass is normal, the interface shown in **Figure 6.2** below will appear. Select *To the Bypass* and click OK to transfer the UPS to Bypass mode; select *Turn off UPS* and click OK to turn off the UPS.

Figure 6.2 Bypass Normal Interface

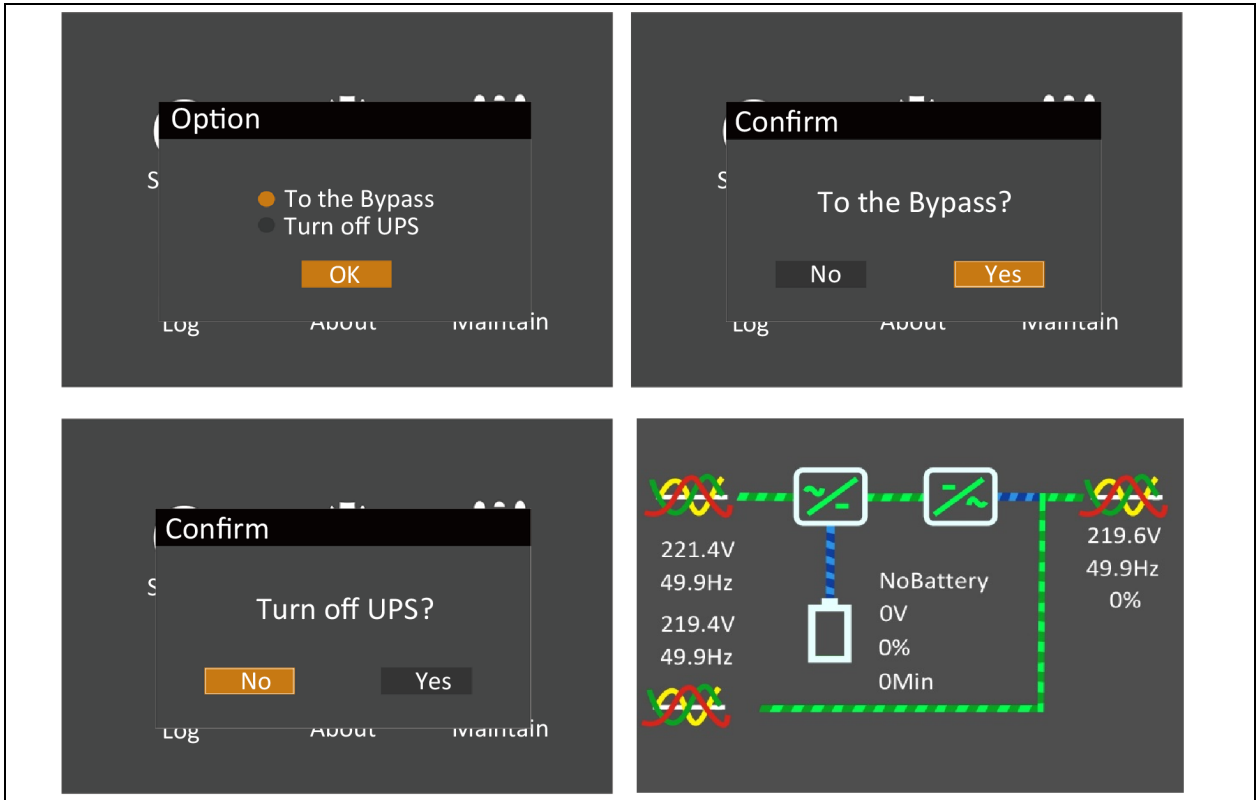

In Inverter mode, press and hold the power button. If the bypass is abnormal, then the interface shown in **Figure 6.3** below will appear, select *YES* to shut down the UPS output.

Figure 6.3 Bypass Abnormal Interface

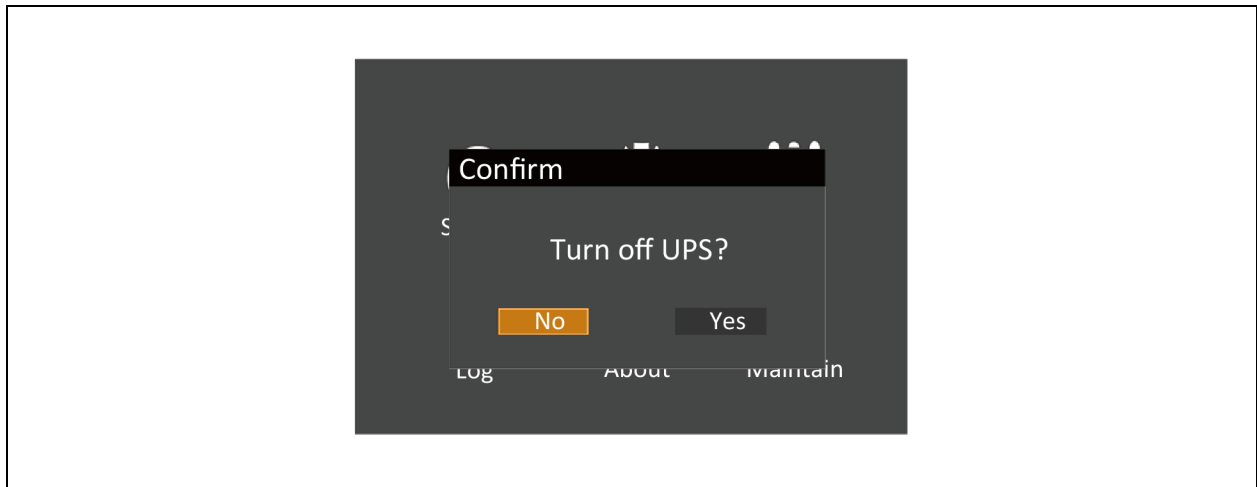

NOTE: In Bypass mode, the load is directly fed by the mains power instead of the pure AC power from the inverter.

For the detailed information of the Normal mode, Bypass mode, Battery and Maintenance Bypass mode, see [UPS State and Operation Mode](#) on page 9.

6.2.3 Transfer from Bypass Mode to Inverter Mode

In Bypass mode, press and hold the *power button*.

If the ECO mode is not turned on, the interface shown in **Figure 6.4** below will appear.

Figure 6.4 ECO Mode Not Turned ON

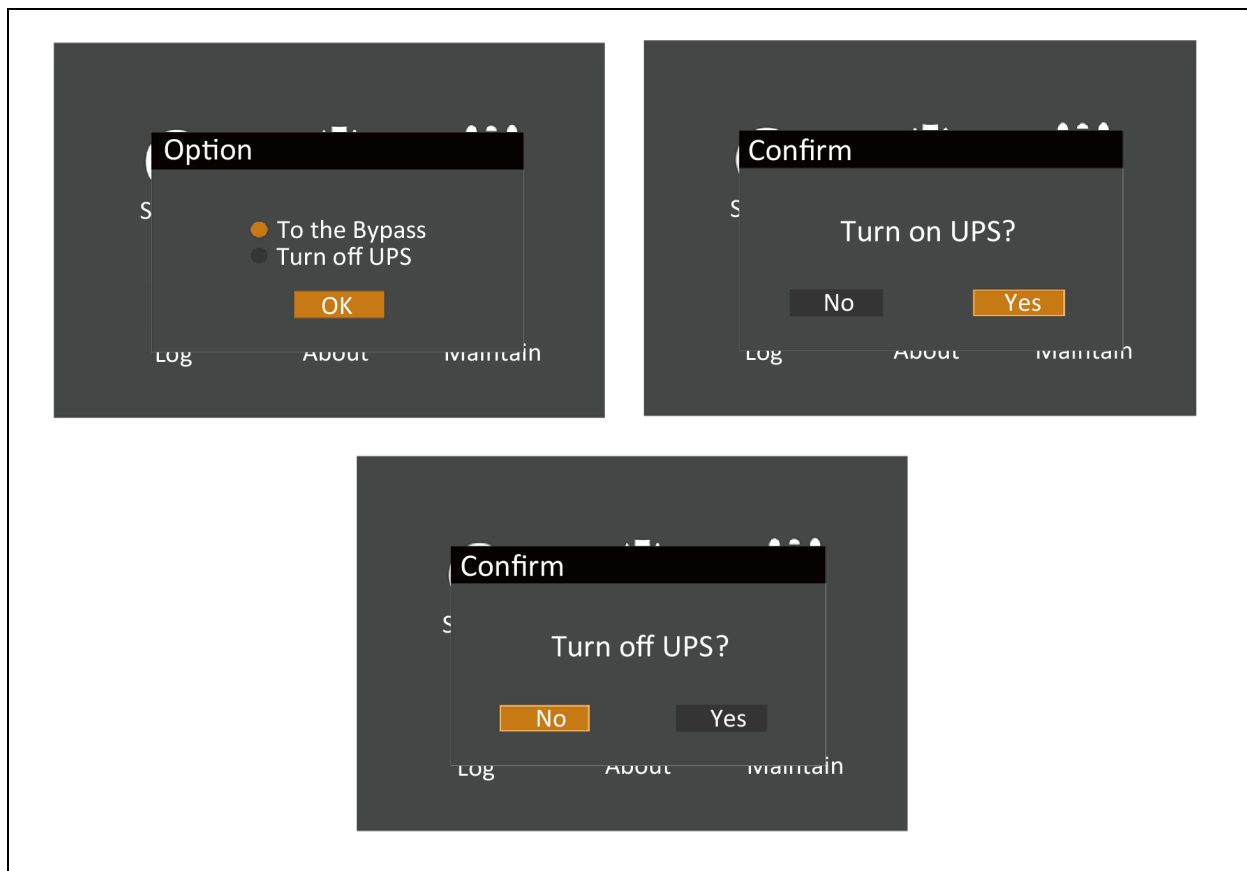

1. Select *Turn on UPS* and click *OK* to transfer to the Inverter mode, see **Figure 6.5** below.
2. Select *Turn off UPS* and click *OK* to shut down the UPS output.

Figure 6.5 Bypass to Inverter Mode

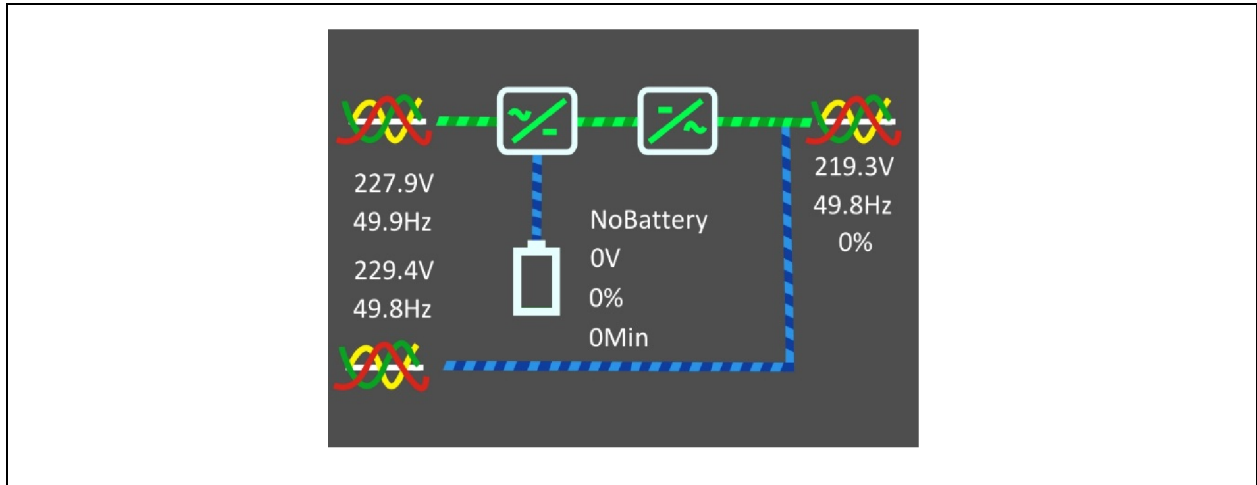

If the ECO turned on, the interface shown in **Figure 6.6** below will appear. Select *YES* to shut down the UPS output.

Figure 6.6 ECO Turned on Interface

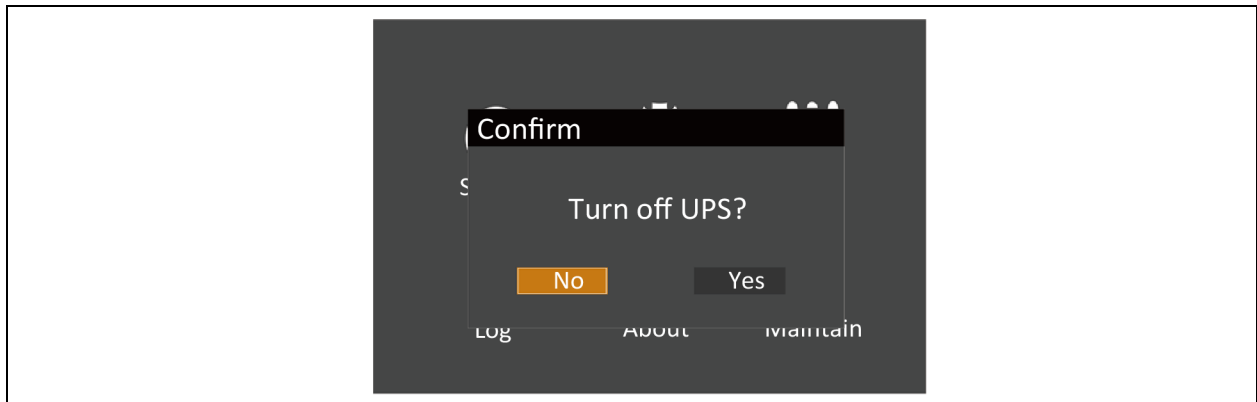

6.2.4 Transfer from Inverter Mode to Maintenance Bypass Mode

When the UPS is running in Normal mode, use this procedure to make the load transfer from inverter output to maintenance bypass.

CAUTION: Before performing this procedure, check the LCD information first, and make sure the bypass is normal and synchronizes with the inverter. Otherwise, it may result in the load power interruption for a while. Select the single POD or prepare the maintenance bypass MCB by yourself to realize this function.

1. Through the LCD settings page, change the Dry connect 3 to Maintain mode. See **Figure 6.7** below.

Figure 6.7 Changing Dry Contact 3 to Maintain Mode

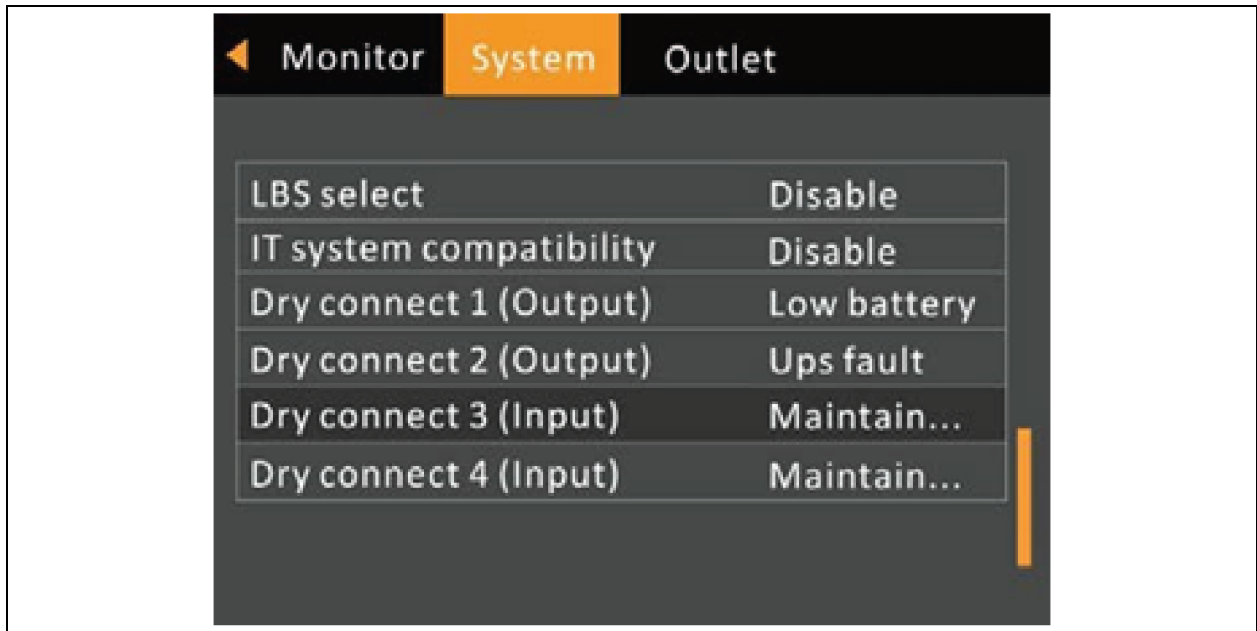

2. Use the *maintenance bypass signal cable* (accessory of POD) to connect Dry Contact Port 3 of the UPS with interlock port on the POD. See **Figure 6.8** below.

Figure 6.8 Ports Connection

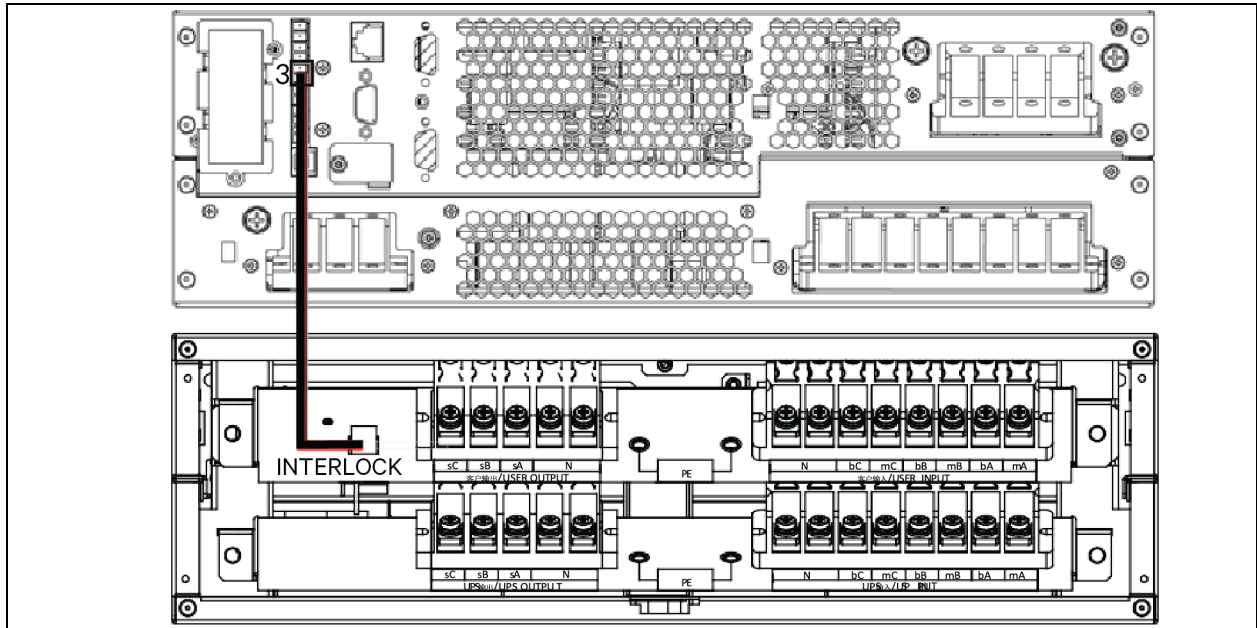

3. Remove the *fixing screws* of the baffle of the maintenance bypass switch, then rotate the baffle upwards till it is completely fixed, fasten the fixing screws.

At this time, the system Interlock function is activated, the UPS will transfer to internal bypass mode.

4. Confirm that the UPS has been transferred to internal bypass mode.
5. After the confirmation, close the *maintenance bypass switch*.
6. Open the *input MCB*, bypass MCB, and output MCB on the front panel of the POD. Open the battery input MCB if outside battery is connected to UPS. Perform the maintenance operation after the UPS complete shutdown.

NOTE: Dry contact port 4 can achieve the same function as dry contact port 3 via the above steps. Use dry contact 1 or 2 on the UPS to cooperate with POD to realize main circuit back-feed protection and bypass back-feed protection. For detailed operation steps, see Vertiv™ Liebert® ITA2 30 kVA UPS Power Distribution Unit User Manual.

6.2.5 Transfer from Maintenance Bypass Mode to Inverter Mode

After UPS maintenance is completed, use this procedure to transfer the load from the maintenance bypass to the inverter.



WARNING! If the maintenance bypass switch is configured by the user, after the UPS maintenance, the user must manually transfer the UPS to bypass mode and then close the output switch. Failure to obey this may cause damage to the equipment.

1. Ensure that the *baffle* of the maintenance bypass switch has been rotated upwards correctly.
2. Close the *mains input* MCB and bypass input MCB on the front panel of the POD. At this time, the UPS will power on again and operate at bypass mode.
3. Confirm that the UPS has operated in Bypass mode, then close the *output* MCB on the front panel of the POD.
4. Open the *maintenance bypass* MCB on the front panel of the POD. Rotate the baffle of the maintenance bypass switch to its original position, then fasten the fixing screws.
5. Press the *power button* on the operation and display panel of the UPS, and the UPS transfers to Inverter mode.

6.2.6 Adding a Single Unit in Parallel System

See [Commissioning Parallel System](#) on page 52 for details.

6.3 UPS Complete Shutdown

For the UPS system with POD, to shut down the UPS completely and make no effect on the use of the load during the UPS power-off, transfer the UPS from Inverter mode to Maintenance Bypass mode according to the procedures in [Transfer from Inverter Mode to Maintenance Bypass Mode](#) on page 86. If the power to the load is not needed, open the input MCB, maintenance bypass MCB and output MCB to shut down the UPS completely. For the system has been transferred to maintenance bypass system, open the maintenance bypass MCB directly, as shown in **Figure 6.9** on the facing page.

Figure 6.9 Configuration of the UPS with External Maintenance Bypass

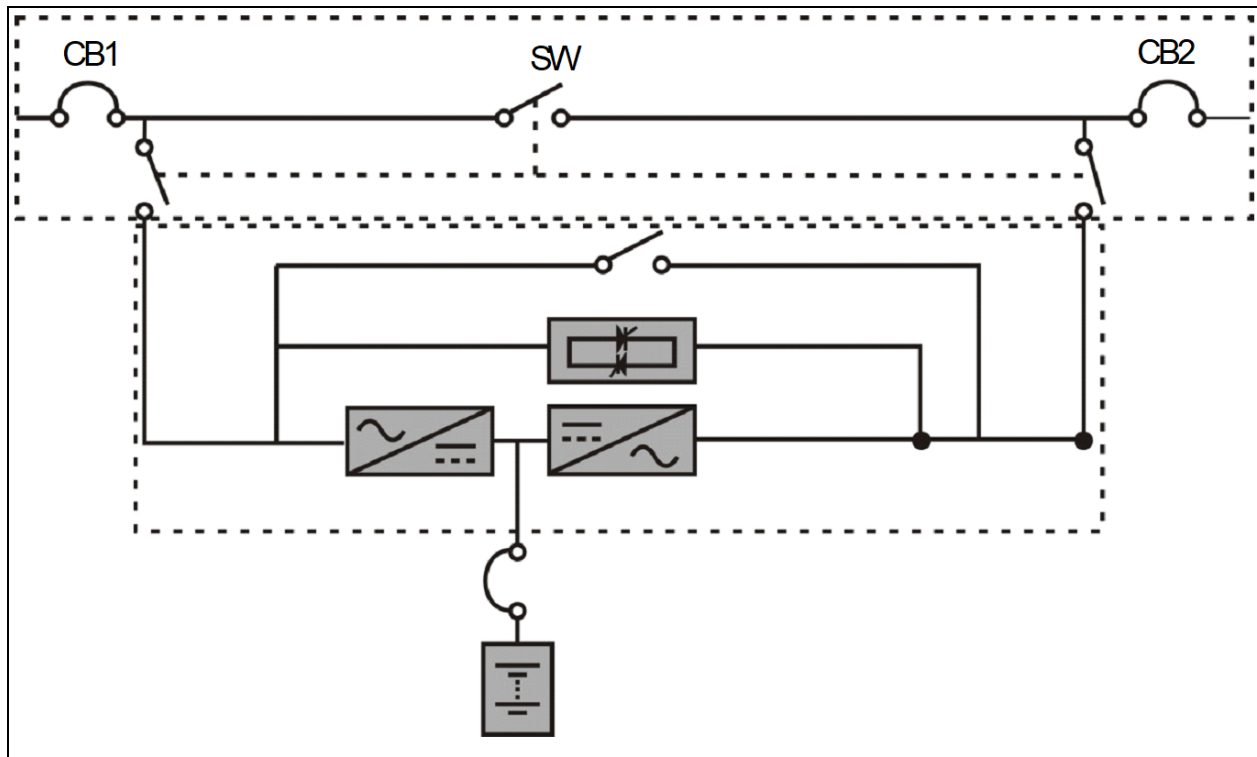

The UPS system distribute power, to isolate the UPS from AC power, disconnect the external input MCB. (If the main and bypass are independently powered, close the two input MCBs).



WARNING! Cut off the maintenance power, to prevent the physical injury.

6.4 REPO

Located at rear of the UPS, the REPO port is designed to switch off the UPS in emergency conditions (such as fire, flood). The system will turn off the rectifier, inverter and stop powering the load immediately (inverter and bypass output included), and the battery stops charging or discharging. Unplug the terminal connected to the REPO for the emergency power-off.

If the mains input is present, the UPS control circuit will remain active; however, the output is closed. To remove all mains power from the UPS, the external main input MCB should be disconnected.

6.5 Auto Restart

In case of the mains power failure, the UPS draws power from the battery to supply the load until the batteries are depleted, then the UPS will shut down.

The UPS will automatically restart and recover output power supply:

- After the mains power is restored.
- The UPS Auto Restart function is enabled.
- After the Auto Restart is delayed (default: 0 second). During the Auto Restart delay, the UPS will charge the battery to provide a safety margin for equipment shutdown if input power fails again.

If the Auto Restart function is disabled, restart the UPS manually by pressing the power button.

6.6 Language Selection

The LCD menus are available in 13 languages:

English	Spanish	Turkish
Chinese	Polish	Russian
German	Dutch	Czech
French	Portuguese	



- At the main menu screen, press the  or  key to switch the cursor to select *Settings*, then press the  key to confirm it. See **Figure 6.10** below.

Figure 6.10 Main Menu



- Press the  key to move the cursor to *Monitor*, see **Figure 6.11** below.

Figure 6.11 Monitor Interface

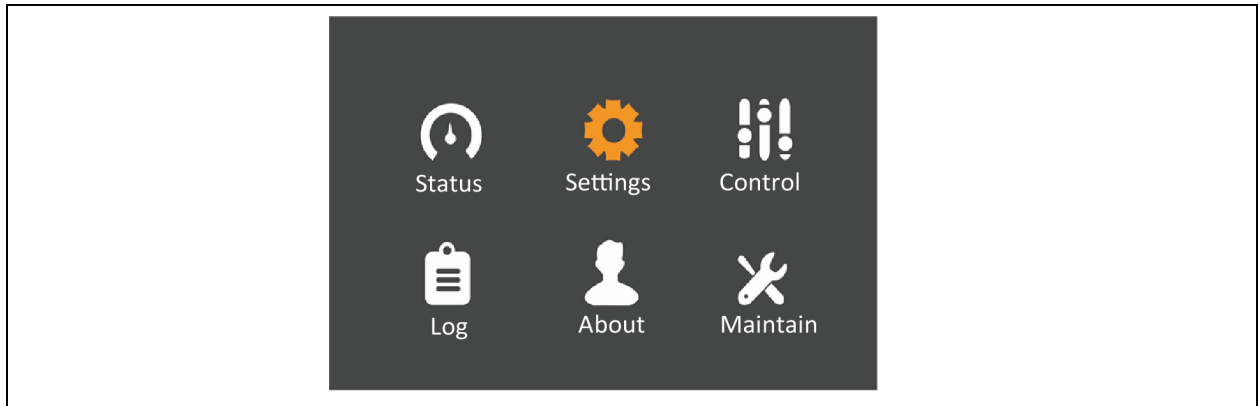

3. Press the  key to highlight the language, see **Figure 6.12** below.

Figure 6.12 Language Selection

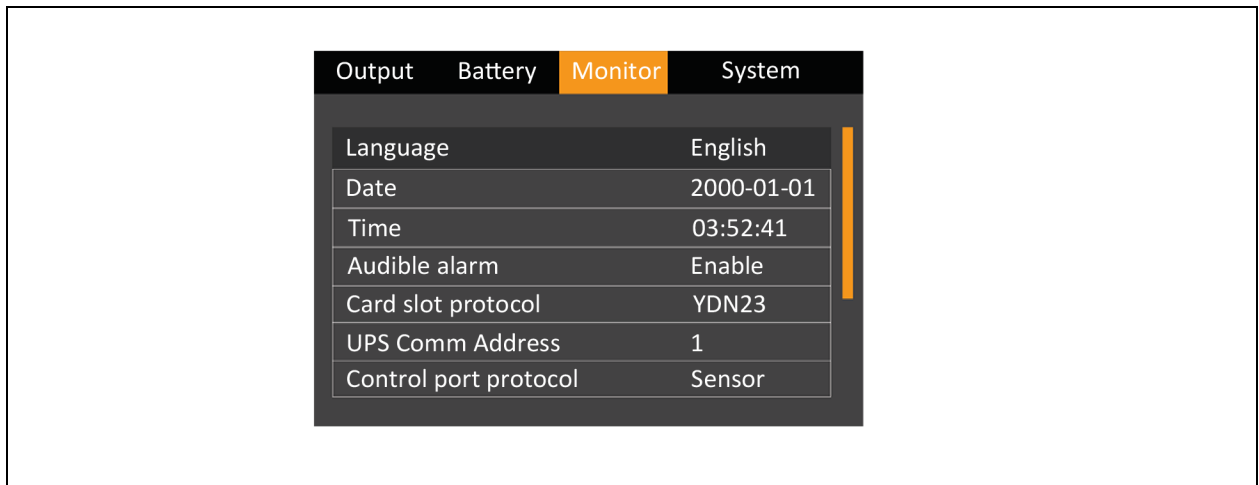



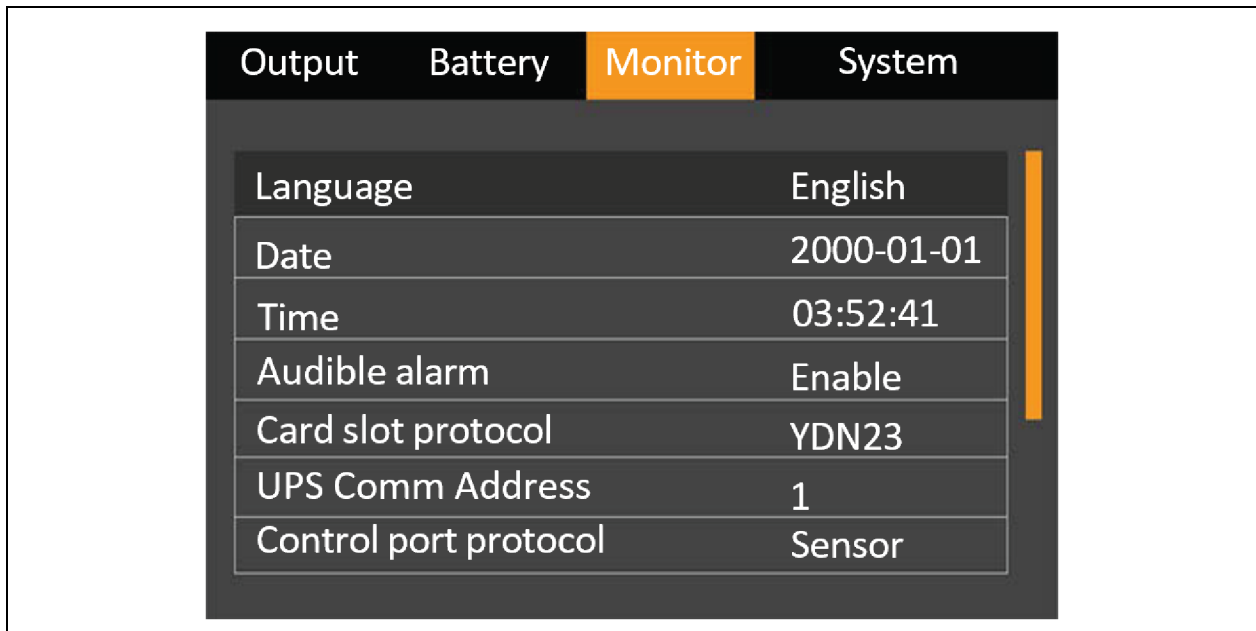

4. Press the  or  key to select the *Language*, then press the  key to confirm it. The LCD will display the content in the selected language by you. See **Figure 6.13** below.

Figure 6.13 Changing Language

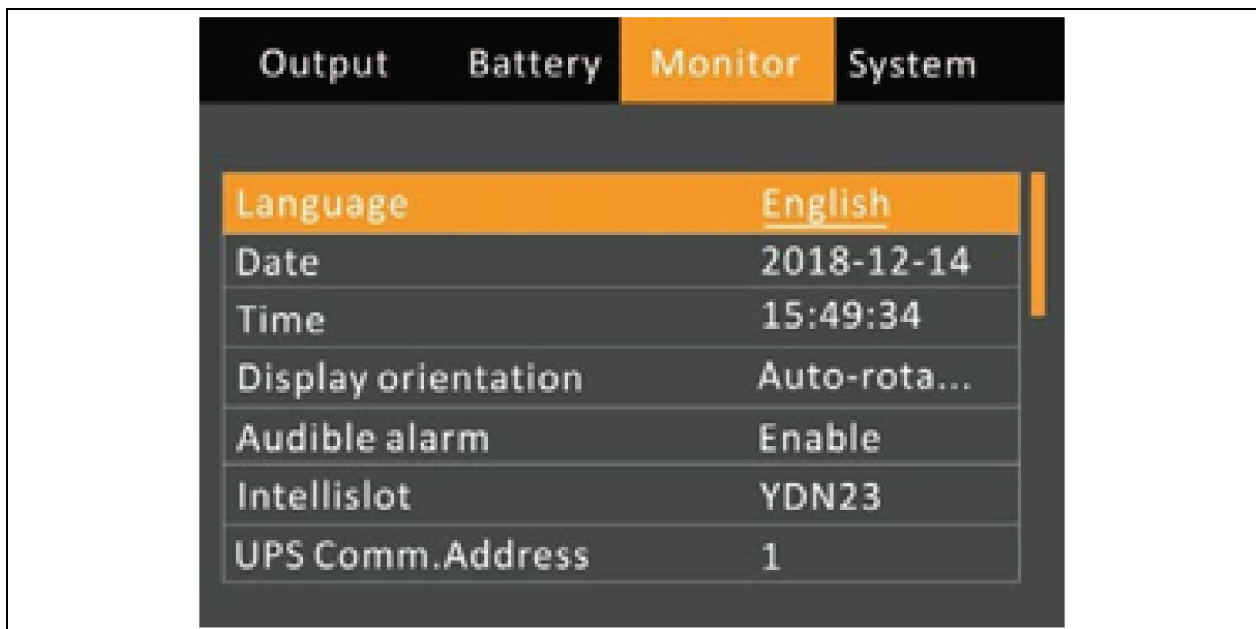

5. Press the  key for several times to get back to the main menu screen.

6.7 Changing Current Date and Time



1. At the main menu screen, press the  or  key to switch the cursor to select 'Settings', then press the  key to confirm it. See **Figure 6.14** below.

Figure 6.14 Main Menu Screen



2. Press the  key to move the cursor to 'Monitor', see **Figure 6.15** below.

Figure 6.15 Monitor Interface

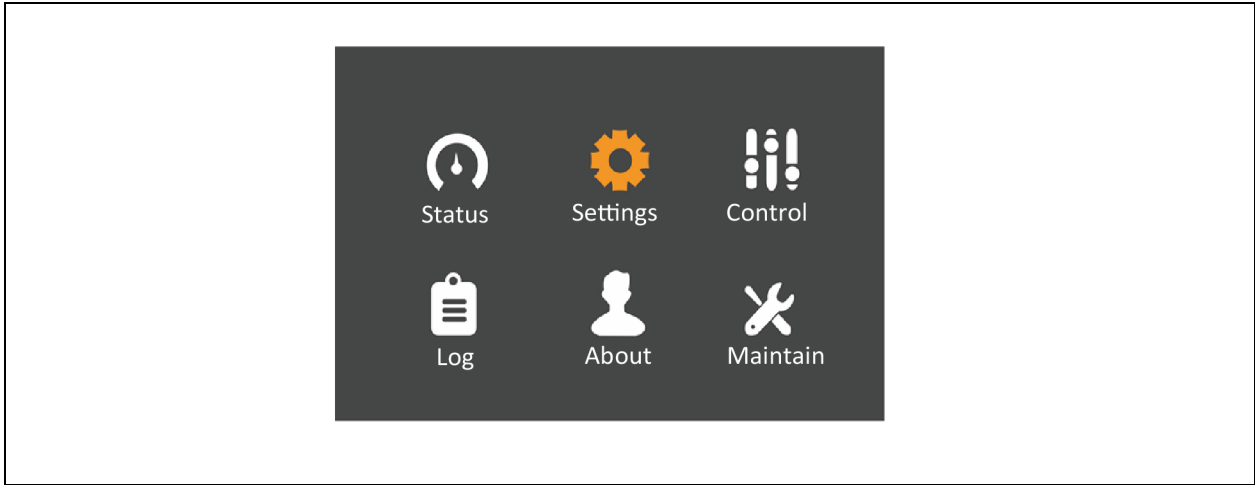

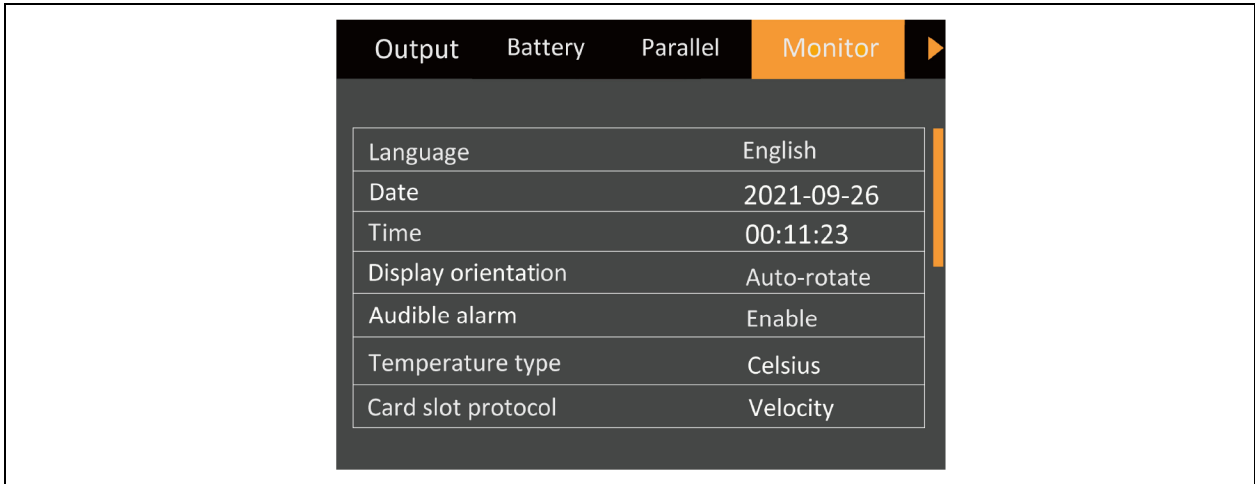

3. Press the  key, and press the  or  key to highlight the date and time, see **Figure 6.16** below.

Figure 6.16 Selection of Date and Time



Output	Battery	Monitor	System
Language		English	
Date		2000-01-01	
Time		03:52:41	
Audible alarm		Enable	
Card slot protocol		YDN23	
UPS Comm. Address		1	
Control port protocol		Sensor	

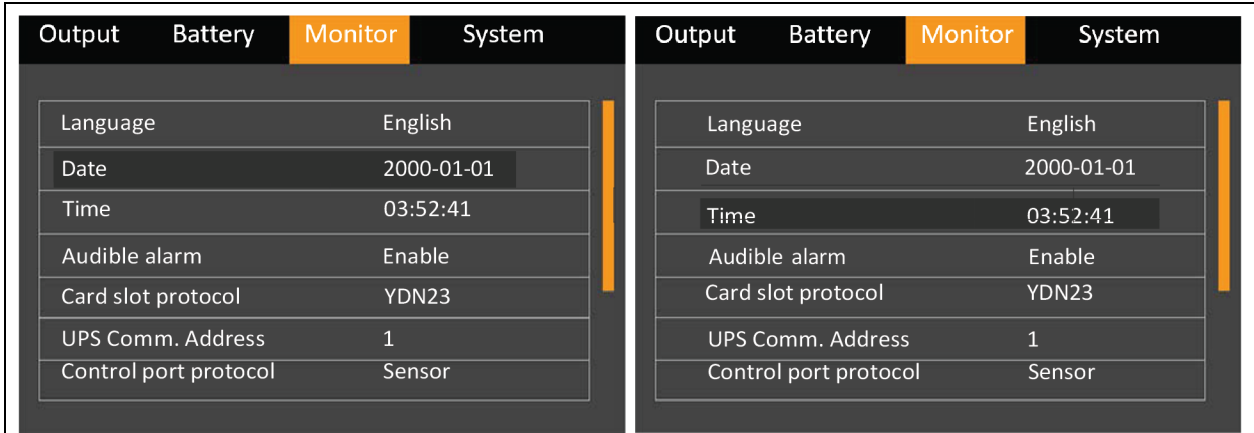

4. Press the  key, move the cursor and press the  or  key to change the date and time. See **Figure 6.17** below.

Figure 6.17 Changing the Date and Time



Output	Battery	Monitor	System
Language		English	
Date		2000-01-01	
Time		03:52:41	
Audible alarm		Enable	
Card slot protocol		YDN23	
UPS Comm. Address		1	
Control port protocol		Sensor	

5. Press the  key to confirm it, and then press the key  several times to get back to the main menu screen.

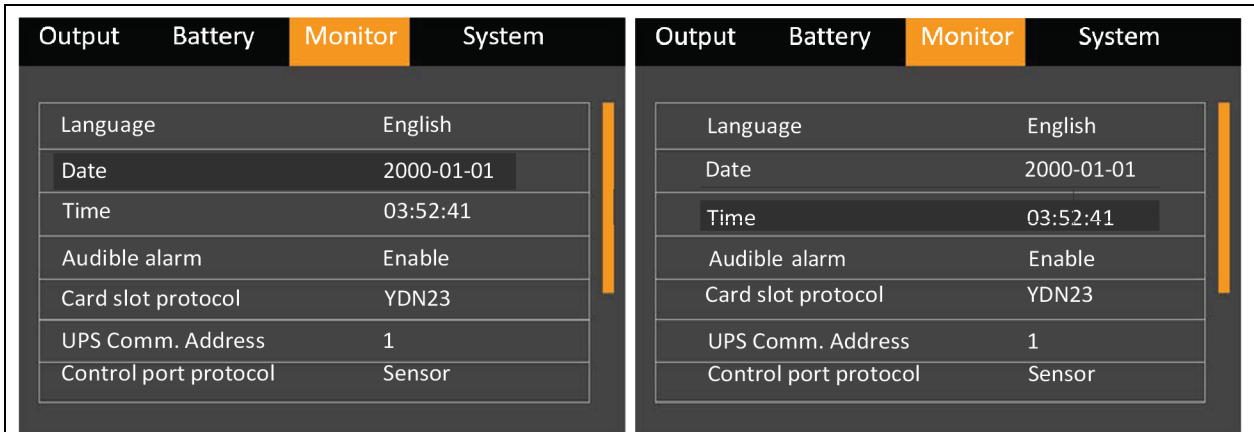
6.8 Setting Password



1. After powering on the UPS, at the main menu screen, press the  or  key to move the cursor to select *Settings*. See **Figure 6.18** below.

Figure 6.18 Main Menu



2. Press the  key, the interface shown in **Figure 6.19** below will appear.

Figure 6.19 Inputting Password

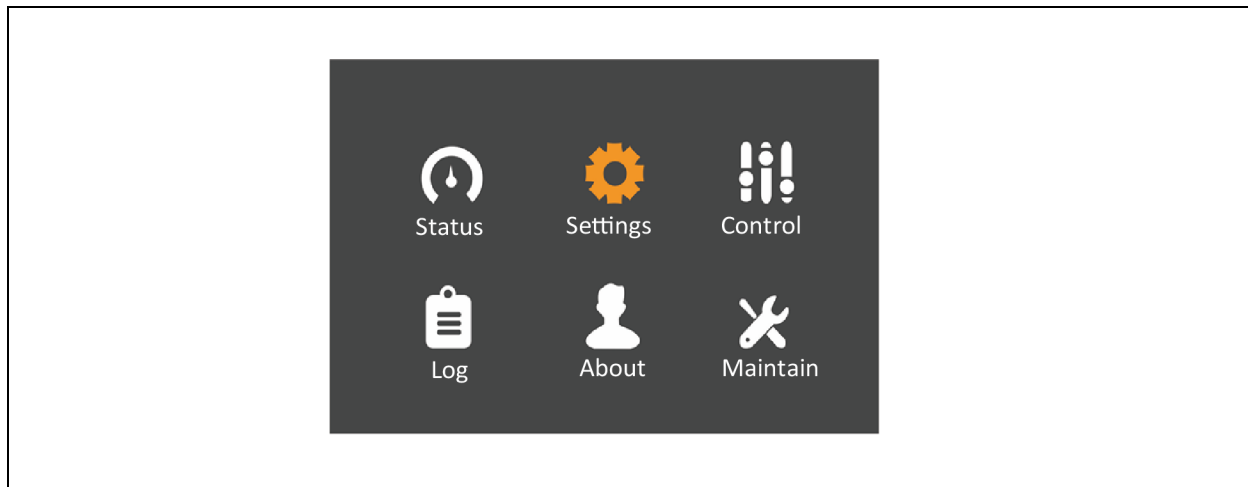

The user can follow the following procedure to change password:

1. Press the  key to move the cursor to the *Monitor*, see **Figure 6.20** below.

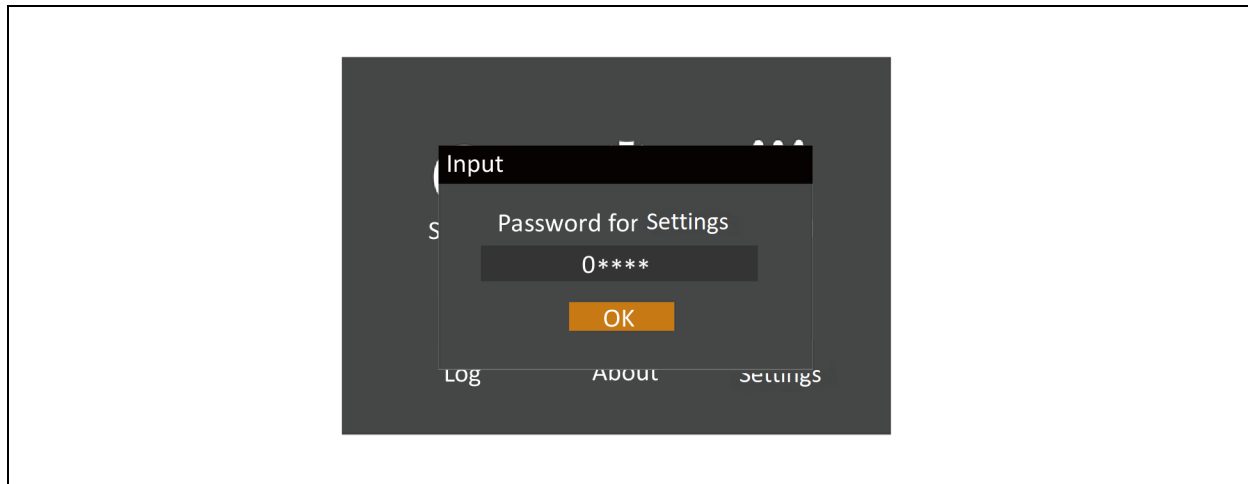
Figure 6.20 Monitor Interface



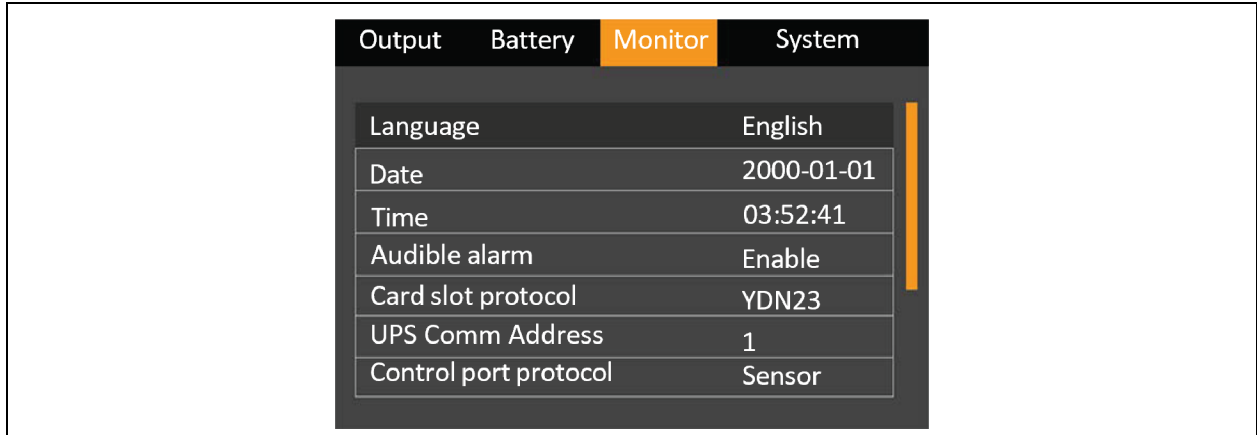

2. Press the  key, then press the  key to select the *Change settings password*, see **Figure 6.21** below.

Figure 6.21 Changing Settings Password



3. Press the  key, the interface shown in **Figure 6.22** below will appear.

Figure 6.22 Password for Settings

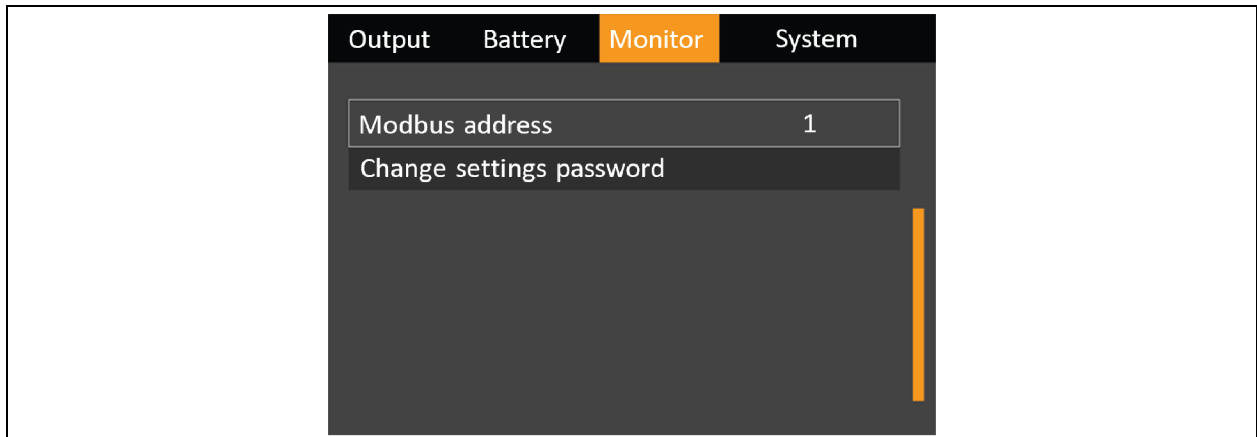

4. Enter the existing password, press the  key to confirm it, then the system requires to enter a new password. See **Figure 6.23** below.

Figure 6.23 Inputting New Password

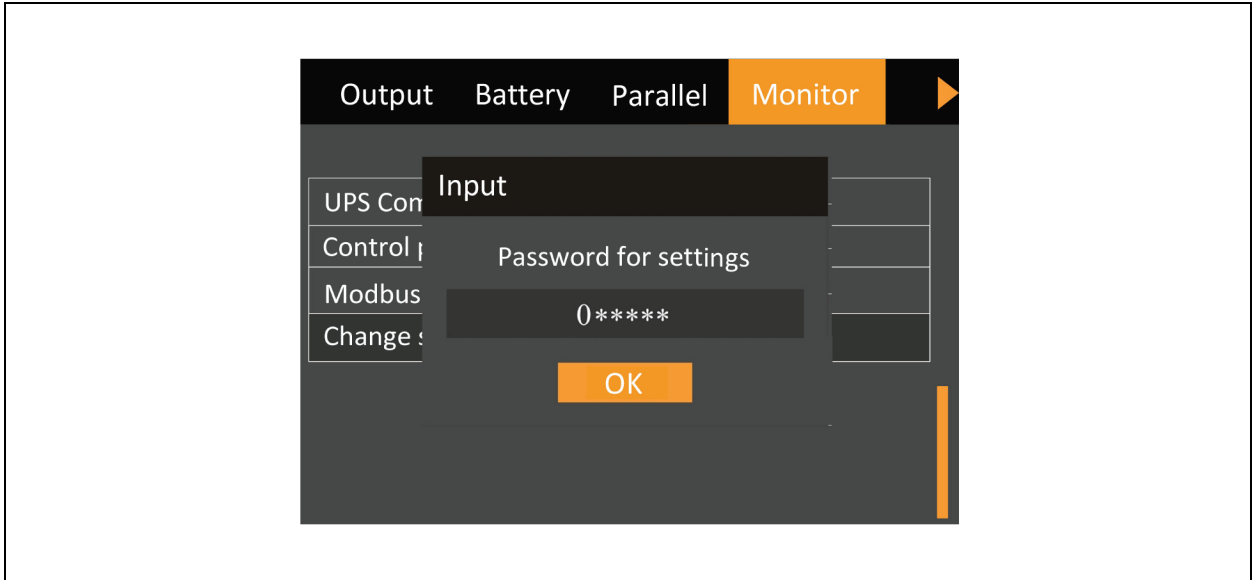

- After entering the new password, press the  key to confirm it, then the system requires to confirm the new password, see **Figure 6.24** below.

Figure 6.24 Confirming New Password

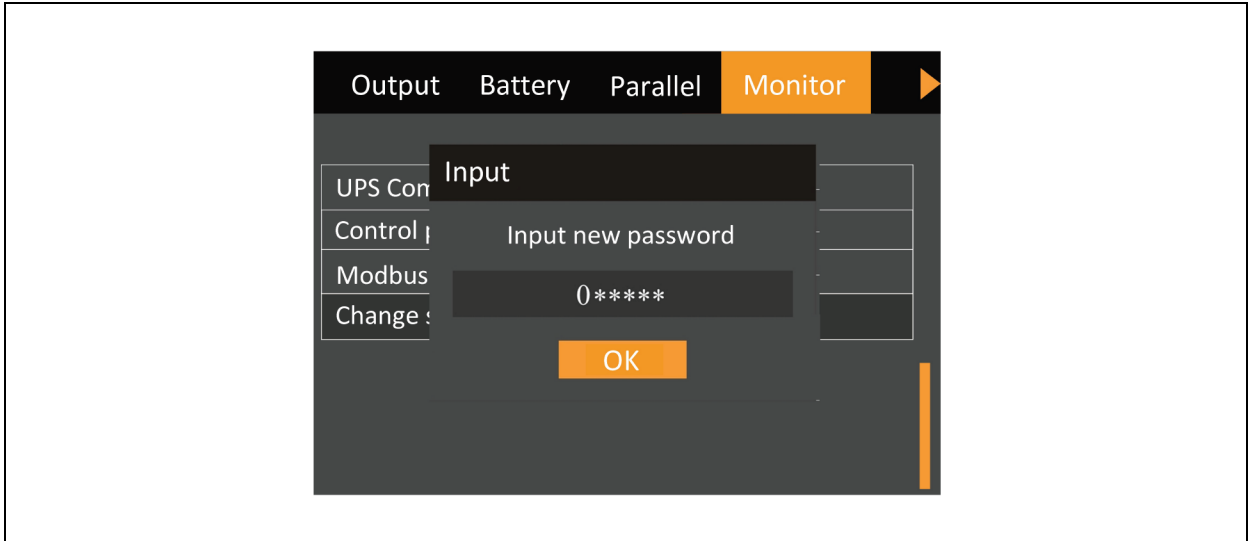

- After the confirmation, press the key and the system prompts that the password changing is successful, see **Figure 6.25** below.

Figure 6.25 Password Changed OK

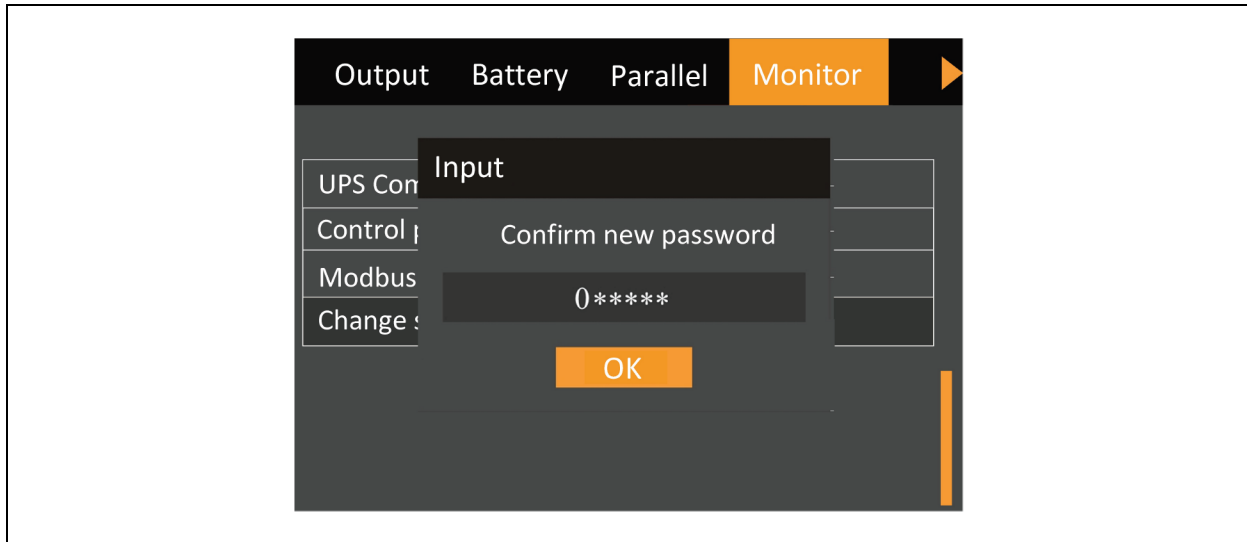
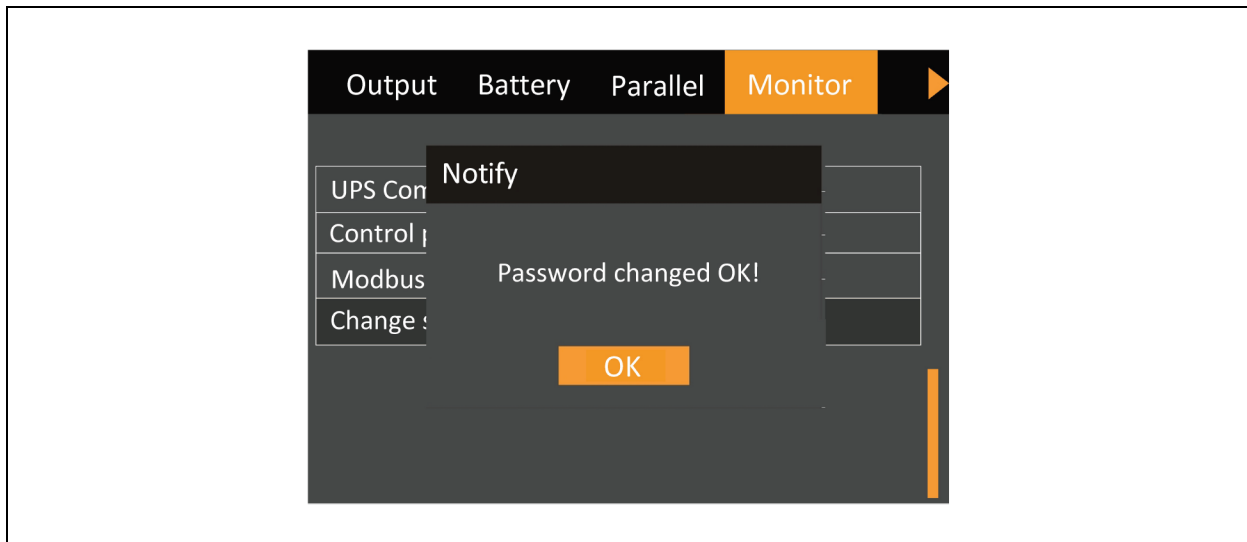

- Press the  key for several times to get back to the main menu screen.

NOTE: Only through the correct password (default: 111111) verification, the parameters of the UPS can be accessed.

This page intentionally left blank

7 Communication

This chapter provides an overview of the UPS communication.

The communication ports includes the following:

- Intelligent card port
- Dry contact port
- 232 port
- Control port and
- USB port

NOTE: It is recommended to keep the signal cable length less than 3 meter and keep it away from the power cable.

7.1 Installing Intelligent Card

7.1.1 Intelligent Card Port

Vertiv™ Liebert® ITA2 30 kVA UPS UPS provides an intelligent card port see **Figure 7.1** below, for installing the communication device options, such as SIC card, RDU-SIC card, UNITY card, RELAY card. Both the intelligent card port and the USB port can be used simultaneously.

Figure 7.1 Intelligent Card Installation (Rear View)

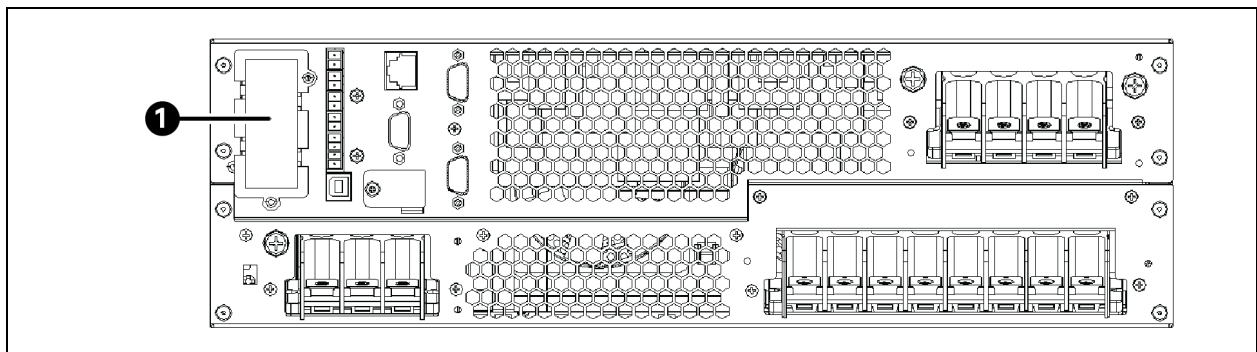

Item	Description
1	Intelligent card port

7.1.2 Intelligent Card Option

SIC Card

SIC card is a network management card, that has network communication capability. SIC card makes the devices intelligent (such as UPS, air conditioner, static transfer system (STS), server power management system (SPM), and etc.). The SIC card can also be used with Vertiv's Network Shutdown that provides safe automatic shutdown function for the computer, on which it is installed, protecting data and reducing loss.

Refer to the corresponding user manual for the installation and operation of SIC card.

RDU-SIC Card

The RDU-SIC card is a network management card that has network communication capability. RDU-SIC card makes the intelligent equipment (such as UPS, PDU and etc.). The SIC card can also be connected to the environment monitoring equipment, such as IRM series or 1-Wire series temperature sensor, temperature and humidity sensor or dry contact signal input and detecting sensors. In case of an intelligent equipment alarm, it notifies the user by multiple ways: recording, sending a Trap message, sending an E-Mail or sending an SMS.

The RDU-SIC card provides four methods to monitor the intelligent equipment and the environment in which it operates:

- **Web Browser** - The Web Browser function of the SIC card allows to monitor the intelligent equipment and the environment in which it operates.
- **Network Management System (NMS)** - The SNMP agent function of the SIC card allows to monitor the intelligent equipment and the environment in which it operates.
- **RDU Manager** - RDU Manager is a piece of management software for equipment room. RDU-Manager can be used to monitor the intelligent equipment and the environment in which it operates through the TCP/IP interface provided by the SIC card.
- **Centralized Management Software (Nform)** - Velocity Server service function provided by the SIC card allows to monitor the intelligent equipment.
- **Power Insight** - The TCP/IP interface of the SIC card allows to monitor the intelligent equipment.

Refer to the corresponding user manual for the installation and operation of SIC card.

RELAY Card

Provide the dry contacts alarm information, such as: batteries, bypass, low battery, alarm, fault and UPS signal, which is used to communicate with remote monitoring system or with Vertiv™ Liebert® MultiLink software used together. The card can accept input signals to shut down the UPS regardless of the current mode of operation.

Refer to the corresponding user manual for installation and operation information.

7.2 Connection Cables for Dry Contact Port

The UPS provides five dry contact ports. The silkprints of the five dry contact ports are 1 to 12. See **Figure 7.2** below for the pin layout of each dry contact port and **Table 7.1** below for the port description.

Figure 7.2 Pin Layout of Dry Contact Ports

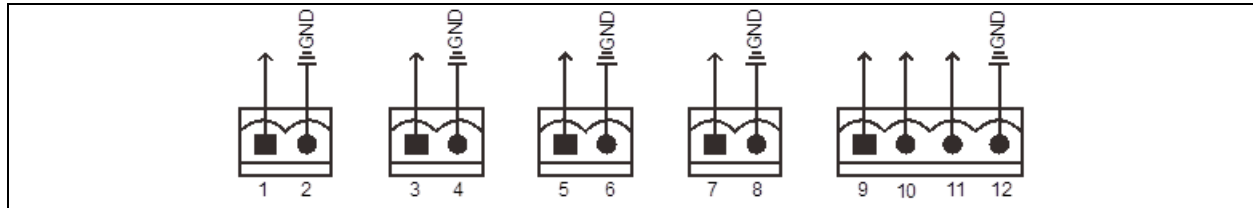

Table 7.1 Pin Layout

Sr. No.	Port Name	Pin No.	Pin Name	Description
1	Output port1	1	LOW_BATTERY/INPUT BACKFEED / UPS_FAULT /ON_BATTERY/ON_BYPASS	Default: LOW_BATTERY, can be set via the LCD settings page. When the system has as alarm, short Pin 1 and Pin 2.
		2	GND	GND
2	Output port 2	3	LOW_BATTERY/ BYPASS BACKFEED/ ON_BYPASS / ON_BATTERY/ UPS_FAULT	Default: UPS_FAULT, can be set via the LCD settings page. When the system has as alarm, short Pin 3 and Pin 4.
		4	GND	GND
3	Input port 1	5	Battery mode shutdown/Any mode shutdown (Remote Comms Shutdown)/Maintain mode/Charger disable mode	Default: Maintain mode, can be set via the LCD settings page. When Pin 5 and Pin 6 are shorted, the function is valid.
		6	GND	GND
4	Input port 2	7	Battery mode shutdown/Any mode shutdown (Remote Comms Shutdown)/ Maintain mode/ Charger disable mode	Default: Maintain mode, can be set via the LCD settings page. When Pin 7 and Pin 8 are shorted, the function is valid.
		8	GND	GND
5	REPO input port*	9	+5 V	REPO power supply, 5 VDC 100 mA.
		10	REPO Coil -NC	NC, ECO activated when Pin 9 and Pin 10 opened.
		11	REPO Coil -NO	Trigger REPO when Pin 11 and Pin 12 closed.
		12	GND	REPO ground

NOTE: The I/O dry contact port capacity is: 125 VDC, 0.5 A; 30 VDC, 1 A respectively.

Pin 11 and Pin 12 reserves the corresponding terminals for configuring the REPO function. The REPO device also needs the shielded cable to connect to the Normally Open remote REPO switch between the two terminals. Pin 9 and Pin 10 should be disconnected, if they are not required. Pin 9 and Pin 10 are shorted before delivery.

NOTE: The EPO action of the UPS will close the rectifier, inverter and static bypass, but it cannot disconnect the UPS mains input inside. If the UPS has to be completely disconnected, just disconnect the upstream input MCB when generating the EPO.

In emergency conditions, close the REPO switch (prepared by users) to shut down the rectifier and inverter, and the UPS will be powered off. In normal condition, the REPO switch cannot cut off the UPS input power. If a switch of electronic control tripping function is used at the UPS input, the REPO switch can help the switch trip and thus cut off the UPS input power. See **Figure 2.3** on page 8 for the position of the REPO switch and see **Figure 7.3** below for the REPO cable connection.

Figure 7.3 REPO Cable Connection

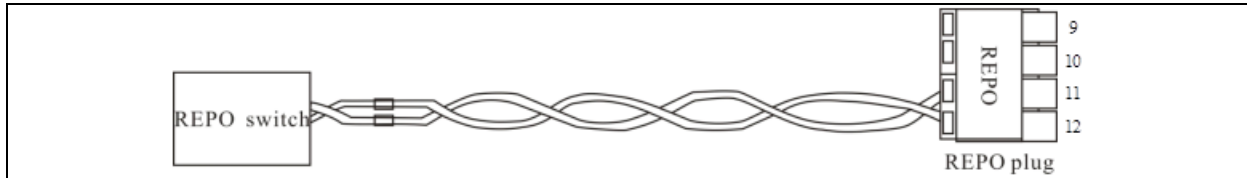

Steps to connect the REPO cable connection are as follows:

1. Loosen '11' and '12' connection terminals of the REPO port.
2. Insert the two ends of the copper core cables into connection terminals '11' and '12' of the REPO port, with the insulation peeled/removed and press down the terminals. The REPO cable connection is complete now.

NOTE: Ensure that the REPO cable is securely connected to avoid no action or incorrect action of the REPO caused by accidental dropping or loose contact.

3. While connecting the REPO cable for parallel UPS, parallel connect '11' of the REPO port with one end of the electronic switch, and parallel connect '12' with the other end of the electronic switch.

When the REPO switch at the user end is closed, the UPS will generate an alarm and cut off the output immediately, and it will not return to the normal operation state automatically. At this point, change the REPO switch state, and power on the UPS manually.

NOTE: It is recommended to use 0.82 mm² to 0.33 mm² (signal cable of 18 AWG to 33 AWG) copper core cable.

NOTE: If the switch you have configured is of electronic control tripping function, when the REPO signal takes action, close the switch before restarting the UPS.

7.3 Connecting USB Communication Cables

The steps to connect the USB communication cable are as follows:

1. Insert one end of the USB communication cable to the USB port, see **Figure 2.3** on page 8 on the rear panel of the UPS, and connect the other end to the USB port of the computer.
2. After the connection, install the USB drive program in the installation disk.

7.4 Connecting Serial Port Communication Cable

The methods to connect the serial port communication cable are as follows:

1. Insert one end of the DB9 serial port communication cable to the DB9 serial port, see port 5 in **Figure 2.3** on page 8 on the rear panel of the UPS, and the other end to the DB9 port of the computer.

The pin function of DB9 is listed below:

Pin No.	Function
2	Send data
3	Receive data
5	Common terminal

7.5 Connecting Control Port

The control port uses the standard RJ45 port, which supports the Modbus/Jbus port and connects the Vertiv temperature and humidity sensor.

The user can select Modbus/Jbus protocol function or sensor function via the Settings option available on the LCD.

7.6 Connecting Built-in Ethernet Port

The built in Ethernet port supports the HTTP protocol. The user can connect one end of the net cable to the Ethernet port of the UPS, and the other end to the built in Ethernet port of the computer. The UPS can be accessed remotely via the IE, Chrome and Firefox, in order to monitor the UPS in real time.

1. Net Cables Connection: Connect one end of the net cable to the Ethernet port of the UPS, and the other end to the built-in Ethernet port (or the switch port, Router port) of the computer.
2. Network Parameters Setting: Change the parameters (IP address, subnet mask, gateway address) of the computer or the UPS, in order to make the computer communicate to the UPS well.

Settings -> Monitor option enables to change the network parameters of the UPS. See **Figure 7.4** below.

Webpage Monitoring Function

Open the web browser (Internet Explorer (IE), Chrome, FireFox etc), enter the IPv4 address into the address bar to access the login interface. Enter the user name and password (default name: user, password: 111111), to monitor the UPS working status.

Figure 7.4 Changing the UPS Network Parameters

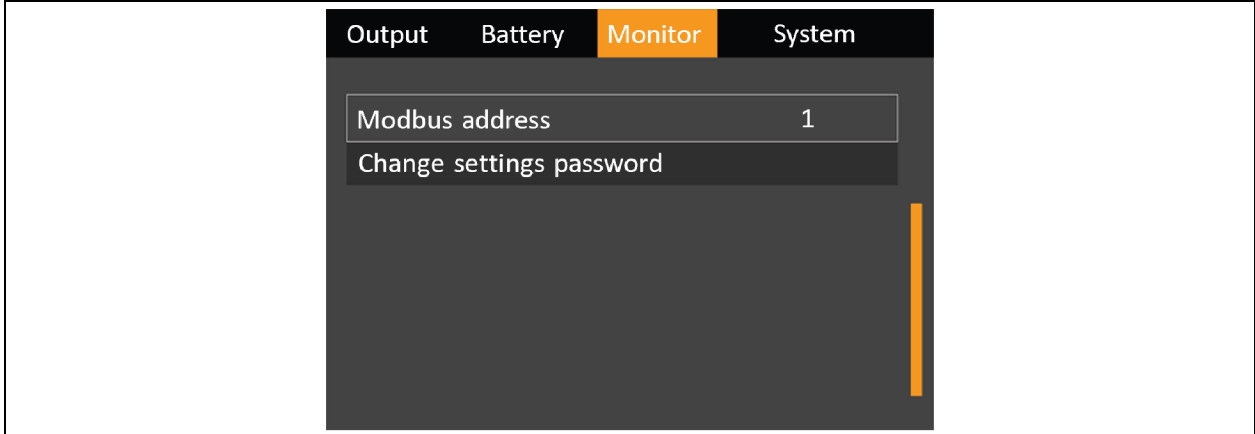

Browser Support

The Internet Explorer (IE9 or above), or the Chrome, FireFox (latest version) are recommended for best user experience.

Power Insight Software Support

Use Power Insight to monitor your intelligent equipment through built-in Ethernet port.

Screen resolution: The display with resolution of 1024x768 or above is recommended.

8 Maintenance

This chapter focuses on the the Vertiv™ Liebert® UPS maintenance, including the fan maintenance, battery maintenance, UPS cleaning, UPS state check, UPS function check.

NOTE: Ensure to remove power before performing the UPS Internal maintenance.

8.1 Fan Maintenance



CAUTION: Do not insert your fingers or or any object/tool into the rotating parts of the fan to avoid damage to the unit or personal injury.

The UPS fans are expected to run for 20000 hours to 40000 hours continuously. The higher the ambient temperature, the shorter the fan life is.

During the UPS operation, verify the fan status once in every 6 months by confirming that air blows out from the ventilation holes on the rear panel.

8.2 Battery Maintenance



WARNING! Never reverse the connection of the battery, otherwise the fire will occur. Never open the battery to avoid physical injury because of the electrolyte. If you accidentally touch the electrolyte, wash the area immediately with plenty of clean water and go to hospital.

The internal battery of the UPS is sealed, lead-acid, maintenance-free battery. The battery life depends on the ambient temperature, charge and discharge times. High ambient temperature and deep discharge shortens the battery life.

To ensure the battery life, it is required to:

- Keep the ambient temperature ranging from 15 °C to 25 °C (59 °F to 77 °F).
- Prevent small current discharge. Continuous battery operation time exceeding 24 hours is strictly prohibited.
- Charge the battery for at least 12 hours, if the battery hasn't been charged for three months at specified ambient temperature, or two months at high ambient temperature.

NOTE: Check and tighten the screws at the battery connection parts regularly the screws at the battery connection parts.

NOTE: Make sure that the safety equipment are complete and that the function is normal, especially that the settings of the battery management parameters are normal.

NOTE: Measure and record the internal temperature of the battery room at regular intervals.

NOTE: Check whether the battery ports are damaged or hot, and whether the chassis and the covers are damaged.

If liquid leakage and damage to the battery are found, place the battery in the anti-vitriol tank, and deal with it according to the local regulations.

The waste lead-acid battery is dangerous waste material. It is one of the national emphases to control the waste battery pollution. Its storage, transportation, usage and disposal must follow the national and local law and other criteria about the dangerous waste material and the waste battery pollution prevention.

According to the related regulations, recycle the waste lead-acid battery, and other disposal methods are prohibited. Throwing away randomly the waste lead-acid battery and other improper disposal methods can result in serious environmental pollution, which will be investigated the legal responsibility.

As the provider of the lead-acid battery, Vertiv has built perfect service network and recycle system for the waste battery to assist users to deal with the waste battery by law. Contact Vertiv or the nearest service center for the detailed information of the recycle system about the waste battery.

Vertiv is not liable for the environment results caused by failure to comply with the notices in this section or to use the waste battery recycle system provided by Vertiv.

8.3 Cleaning UPS

Clean the UPS periodically, especially the ventilation holes, to ensure free airflow inside the UPS. If necessary, clean the UPS with a vacuum cleaner. Confirm that the ventilation holes are not blocked or obstructed.

8.4 Checking the UPS Operating Status

It is recommended to check the UPS operation status once in every 6 months.

Check the following items:

1. If the UPS alarm is faulty: Is the alarm indicator on? Is the UPS giving any alarm?
2. If the UPS is operating Bypass Mode, One of the reason for this could be operator intervention, overload, internal fault, and so on.
3. If the battery is discharging: One of the reason for this could be mains failure, battery test, operator intervention, and so on.

8.5 Checking UPS Functions

NOTE: UPS functions check procedures may cause power interruption to load.

It is recommended to check the UPS functions in every 6 months.

NOTE: Backup the load data before conducting the UPS functions check.

Steps to check the UPS functions are as below:

1. Press the *power button* to check if the buzzer beeps, indicators are on and the LCD display is normal.
2. Press the *ESC key* to check again if the indicators are on, the LCD display is normal and the UPS has been transferred to the inverter mode.

9 Options

This chapter includes the options of the Vertiv™ Liebert® ITA2 UPS.

9.1 Options

See **Table 9.1** below for the options.

Table 9.1 Options

Option	Model	PN	Description
POD	ITA-30k00POD01	02312839	Single POD (with maintenance bypass)
	ITA-30k00POD02	02312840	1+1 POD (1 with maintenance bypass); 2+0 parallel system not available
Communication Cables	ITA-20k00AL3A02C00L1	04114664	UPS parallel communication cables 1 m (3.28 ft.)
	ITA-20k00AL3A02CL3	04112730	UPS parallel communication cables 3 m (9.84 ft.)
Guide Rail	UF-RMKIT2438	UF-RMKIT2438	Guide rail for rack installation
Dual Bus Assembly	ITA-20k00AL3A02C00L2	04112519	LBS cables 1 m (3.28 ft.)
	ITA-30k00AL3302CL1	04113595	LBS cables 5 m (16.4 ft.)
	ITA-30k00AL3302CL2	04114010	LBS cables 10 m (32.8 ft.)
Communication Options	RDU-SIC	RDU-SIC	RDU SIC card is used for the Intellislot series UPS
	UF-SNMP810	UF-SNMP810	SIC card is used for Intellislot series UPS
	IS-UNITY-DP	IS-UNITY-DP	UNITY card is used for Intellislot series UPS
	IS-RELAY	IS-RELAY	RELAY card is used for Intellislot series UPS
Sensor	IRM-S01T	IRM-S01T	Intelligent temperature sensor
	IRM-S02TH	IRM-S02TH	Intelligent temperature/humidity sensor
Battery module	ITA-BCI0020k01	02010024	(2U) Built-in battery module with 16-block 12 V (9 Ah) batteries
	ITA-BCI0020k02	0235A02J	(3U) Built-in battery module with 16-block 12 V (9 Ah) batteries
	ITA-BLI0020KL2	02010529	(2U) Battery module with 192 V (12 Ah) Lithium-ion batteries

9.2 POD

POD (option of the UPS) can provide safe and reliable power distribution function. The descriptions of the POD are listed in **Table 9.2** below.

Table 9.2 POD

Type	PN	Name	Description W × D × H mm (Inch)
ITA-30k00POD01	02312839	Single POD (with maintenance bypass)	430 x 600 x 173 (16.93 x 23.62 x 6.81)
ITA-30k00POD02	02312840	1+1 POD (with maintenance bypass)	430 x 600 x 261 (16.93 x 23.62 x 10.28)

For the installation and commissioning of the POD, refer to **Vertiv™ Liebert® ITA2 30 kVA UPS Power Distribution Unit User Manual**.

Remove the plastic panel to reveal the POD front panel; remove the rear baffle plate to reveal the POD rear panel. The front panel and rear panel of the single POD are shown in **Figure 9.1** below. The front panel and rear panel of the 1+1 parallel POD are shown in **Figure 9.2** on the facing page.

Figure 9.1 Front Panel and Rear Panel of the Single POD

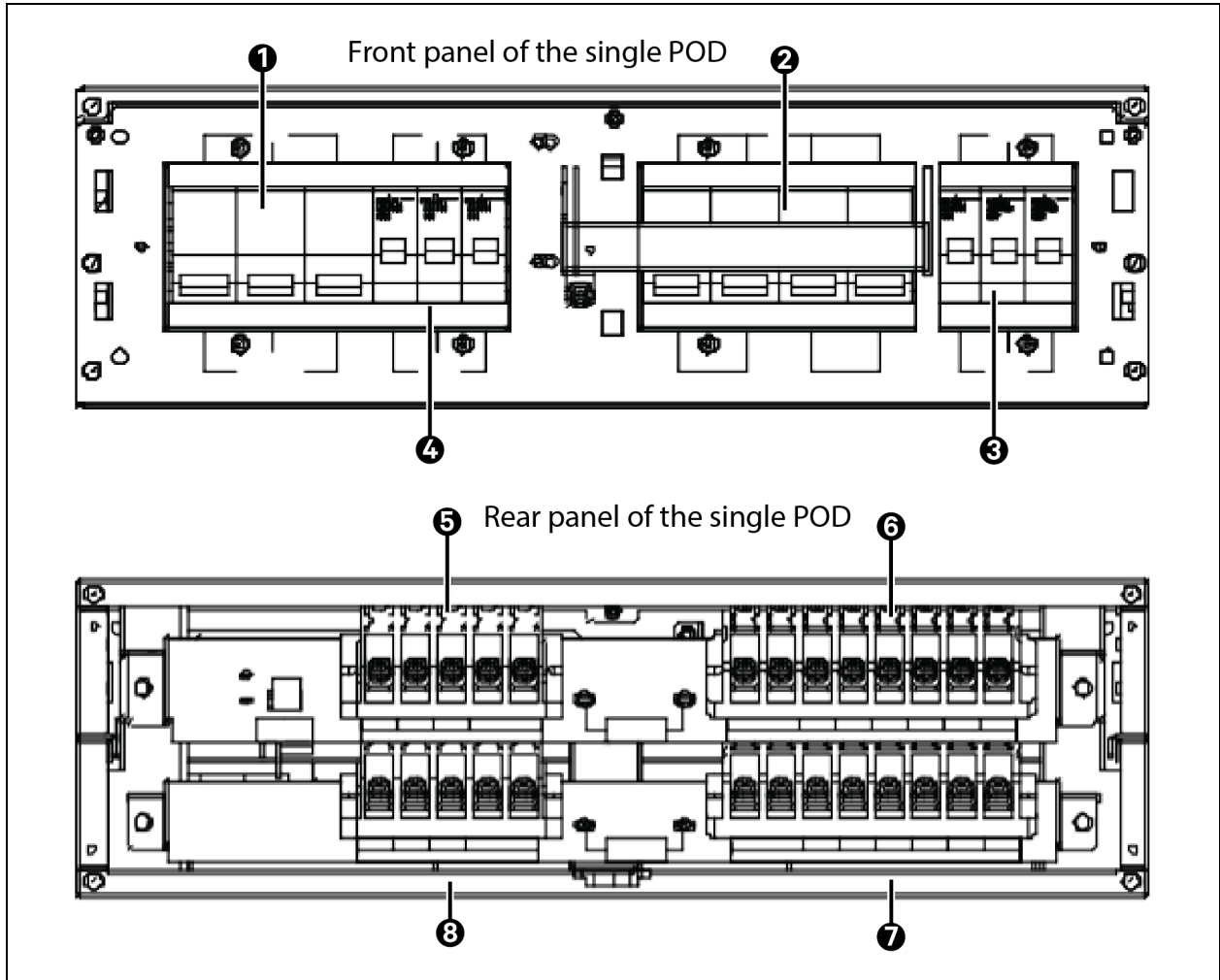

Item	Description
1	Main Input MCB
2	Maintenance Bypass MCB
3	Output MCB
4	Bypass input MCB
5	User Output Terminals
6	User Input Terminals
7	UPS Output Terminals
8	UPS Input Terminals

Figure 9.2 Front Panel and Rear Panel of the 1+1 Parallel POD

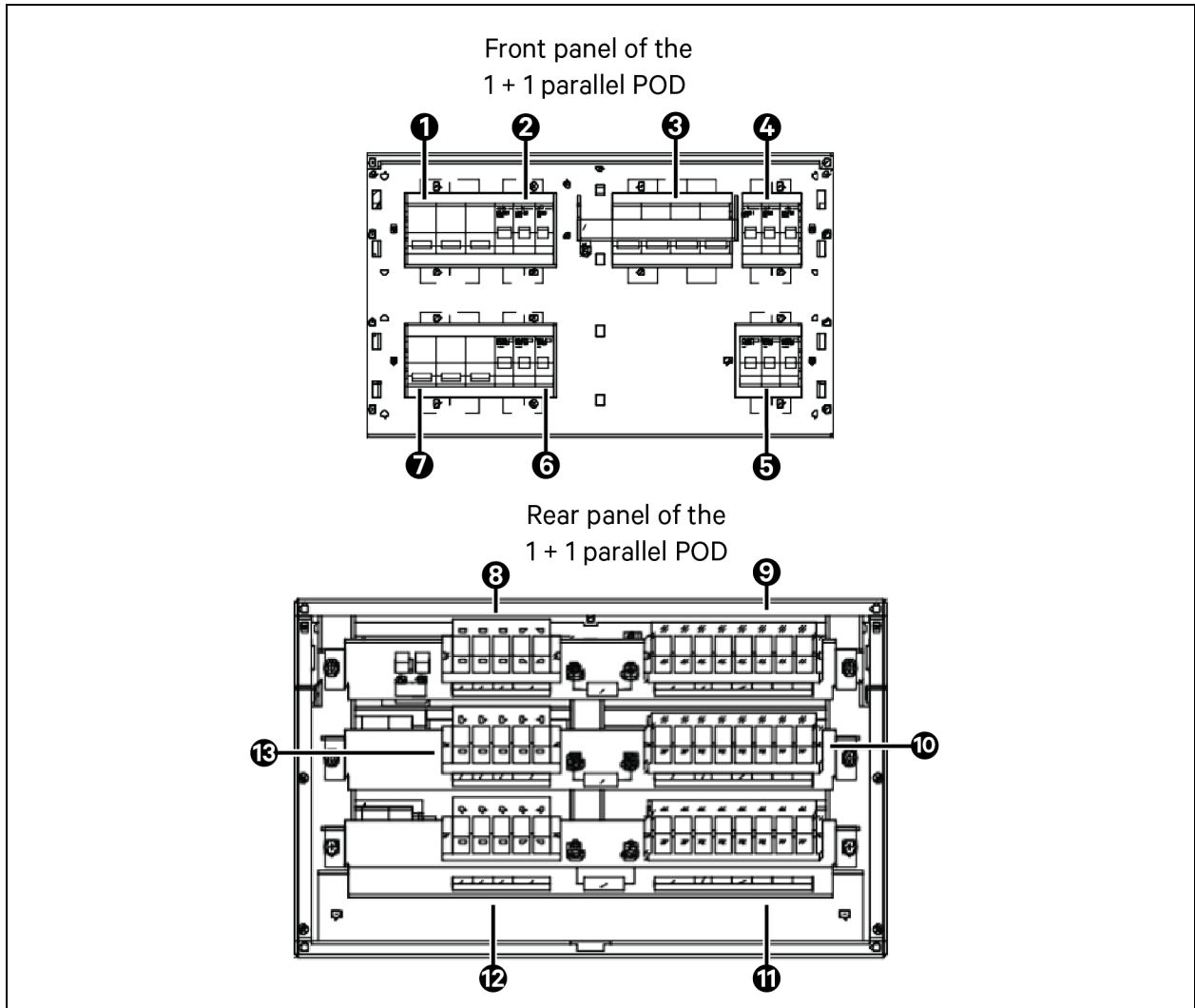



Item	Description	Item	Description
1	UPS1 Main Input MCB	8	User Output Terminal
2	UPS1 Bypass Input MCB	9	User Input Terminals
3	Maintenance Bypass MCB	10	UPS1 Input Terminals
4	UPS1 output MCB	11	UPS2 Input Terminals
5	UPS2 Output MCB	12	UPS2 output Terminals
6	UPS2 Bypass Input MCB	13	UPS1 output Terminals
7	UPS2 main Input MCB		

9.3 Communication Cables

Communication cable is compulsory in parallel system. See **Table 9.3** below for cable description. Refer to [Connecting Power Cables](#) on page 47 for the methods to connect the parallel cables.

Table 9.3 Description of the Communication Cable

Parallel Communication cable Type	Part Number	Description	Appearance
ITA-20k00AL3A02C00L1	04112519	For N+1 parallel system, N+1 communication cables 1 m (3.28 ft.) are required. For example, two communication cables are required in 1+1 parallel system; three communication cables are required in 2+1 parallel system; four communication cables are required in 3+1 parallel system.	
ITA-20k00AL3A02CL3	04112730	For N+1 parallel system, N+1 communication cables 3 m (9.84 ft.) are required. For example, two communication cables are required in 1+1 parallel system; three communication cables are required in 2+1 parallel system; four communication cables are required in 3+1 parallel system.	

9.4 Guide Rail

The guide rail is used in rack installation of the UPS, POD (optional). The detailed description is listed in **Table 9.4** below.

Table 9.4 Description of the Guide Rail

Type	Name	Description	Appearance
UF-RMKIT2438	Guide rail for rack installation	A set of guide rail includes a left guide rail and a right guide rail, and its bearing and its bearing capacity is 50 kg (110 lbs). Use the guide rail in the rack installation. It is applicable to the various server cabinet, the UPS, and the POD.	

For the rack mode installation procedure, see [Rack Installation](#) on page 25.

9.5 Dual Bus Parts

The LBS cables are compulsory in dual bus system. See **Table 9.5** below for the dual bus parts.





Table 9.5 Dual Bus Parts

LBS Cable Type	Part Number	Description	Appearance
ITA-20k00AL3A02C00L2	04112519	Used to form LBS system 1 m (3.28 ft.). Two LBS cables are recommended.	
ITA-30k00AL3302CL1	04113595	Used to form LBS system 5 m (16.40 ft.). Two LBS cables are recommended.	
ITA-30k00AL3302CL2	04114010	Used to form LBS system 10 m (32.80 ft.). Two LBS cables are recommended.	

9.6 Communication Options and Temperature and Humidity Sensor

The communication and the monitoring options are listed in **Table 9.6** below.

Table 9.6 Communication and Monitoring Options

Name	Type	Description	Appearance
SIC card	UF-SNMP810	Remote monitor UPS through TCP/IP protocol and Internet. Support remote safe shutdown. Provide an extended net port, cascade-connect up to eight temperature humidity sensors.	
RDU SIC card	RDU-SIC	Be used to connect UPS to RDU-SIC monitoring unit, or connect to the cascade-communication in parallel system.	
UNITY card	IS-UNTIY-DP	Unity card adopts Ethernet network to monitor and manage various operating parameters, alarms and notifications about power, distribution and cooling equipment. The card also communicates with the building management system and the network management system.	
Relay card	IS-RELAY	1. It can be connected to remote 4-route relay switch signal output: Low battery, On bypass, On battery, UPS fault. Each dry contact output includes a normally open and normally closed interface for user selection. 2. The relay card can receive 3-route switch signal input, two of which control UPS startup and shutdown functions, and the third one is reserved.	
Intelligent temperature sensor	IRM-S01T	With LCD screen, connects the SIC card or the multifunction port.	
Temperature humidity sensor	RDU-A-S02TH	With LCD screen, connects the SIC card or the multifunction port.	

NOTE: While using the SIC card to connect to the temperature sensor as battery temperature compensation, connect to the COM1 port of the SIC card, and set DIP switch of the temperature sensor to 1. For the installation and setting of the SIC card, refer to RDU-SIC Card User Manual.

9.7 Battery Module

9.7.1 List of Battery Module Options

See Table 9.7 below for a list of battery module options.

Table 9.7 Battery Module Options

PN	Name	Description	Dimensions W x D x H mm (Inch)	Weight kg (lbs.)
02010024	Battery module (2U)	The built-in 16-block 12 V 9 Ah VRLA batteries are used to extend the system operation time. NOTE: The recommended number of battery modules for expansion is 8. For a 30 kVA UPS, the number of battery modules for expansion must be a multiple of 4. The battery module accessories include a cable and one signal cable.	430 x 755 x 85 (16.93 x 29.72 x 3.35)	57 (125.66)
0235A02J	Battery module (3U)	The built-in 16-block 12 V, 9 Ah VRLA batteries are used to extend the system operation time. NOTE: The recommended number of battery modules for expansion is 8. For a 30 kVA UPS, the number of battery modules for expansion must be a multiple of 4. The battery module accessories include a cable and one signal cable.	430 x 600 x 130 (16.93 x 23.62 x 5.12)	51 (112.4)
02010529	Battery module (2U)	Battery module with 192 V, 12 Ah Lithium-ion batteries.	430 x 680 x 86 (16.9 x 26.8 x 3.4)	35 (77)

PN	Name	Description
ITA-BCI0020K02L1	VRLA battery module connection cable	1 every 2 battery modules, starting from the second string)
04T14664	Connection cable between ITA2 30 kVA UPS and 2U LIB battery modules	1 meter (1 each UPS)
04T12730	Parallel cable (3 meter) for ITA2 10 kVA to 40 kVA	3 meter (1 each UPS)
04T1A753	VRLA battery connection cable	Connection cable between the UPS and the battery module

NOTE: The battery circuit is not insulated from the AC input. There may be a hazardous voltage between the battery interface and ground. Do not touch it with your hands, or you may get an electric shock.

NOTE: The cable needs to be configured separately. The 30 kVA UPS is equipped with ITA-40k00BCI01L1.

9.7.2 Appearance of VRLA Battery Module

The appearance of battery module is shown in **Figure 9.3** below.

Figure 9.3 Appearance of VRLA Battery Module

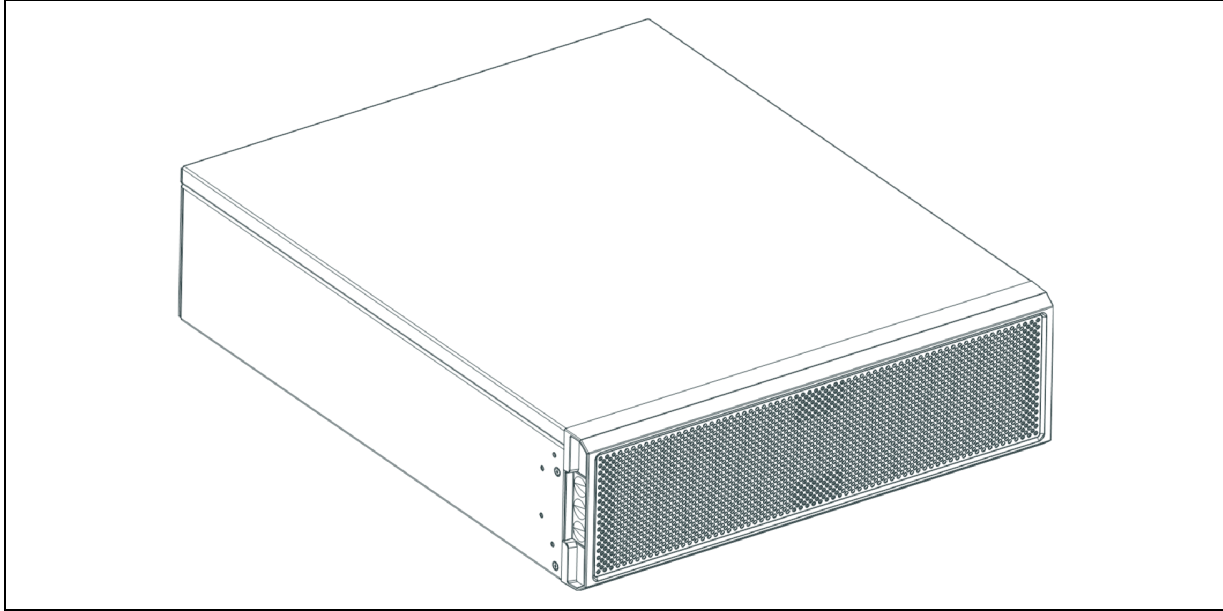

There is no operation and display panel on the front panel of the battery module. The plastic panel is detachable and the direction of the plastic panel of the battery module can be adjusted as needed, as shown in **Figure 9.4** below.

Figure 9.4 Position of Plastic Panel

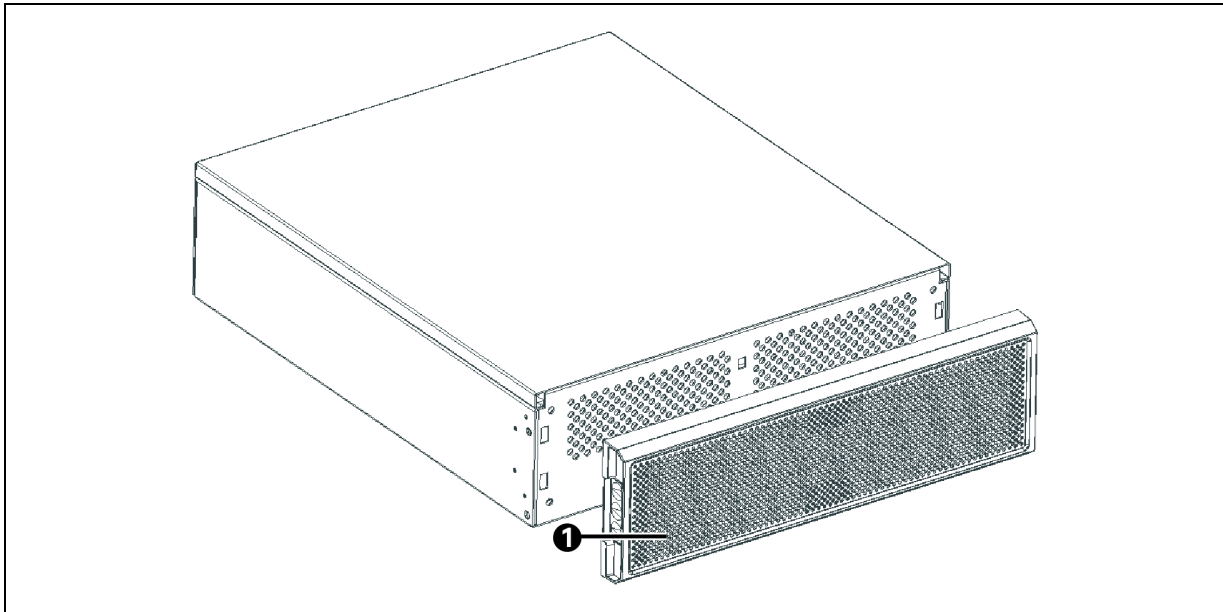

Item	Description
1	Plastic panel

There are battery interfaces, battery output switch and ventilation holes on the rear panel, as shown in **Figure 9.5** below.

Figure 9.5 Rear Panel of VRLA Battery Module

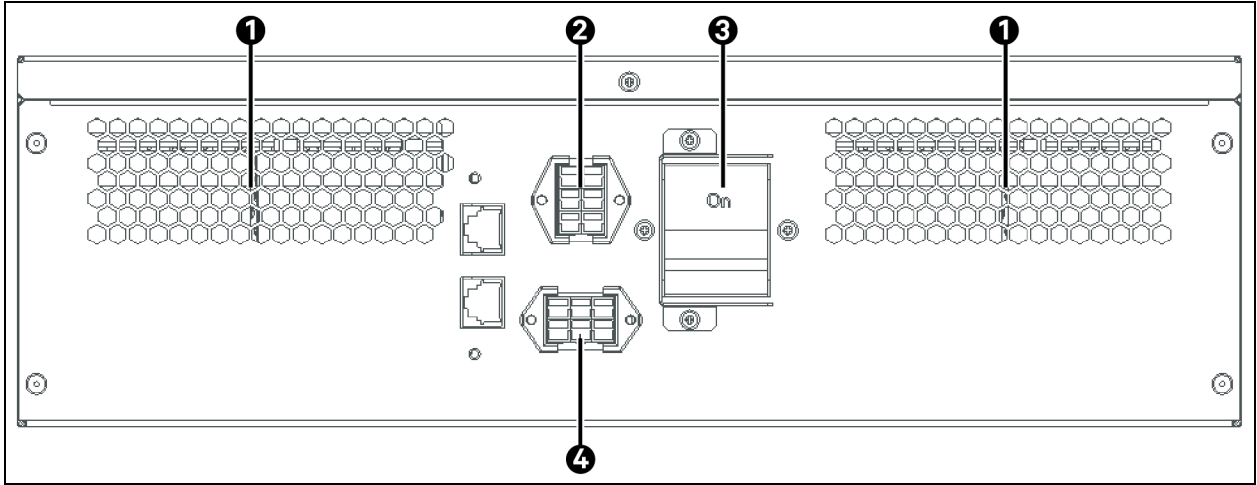

Item	Description	Item	Description
1	Ventilation hole	3	battery output switch
2	Battery interface A	4	Battery interface B

9.7.3 Appearance of Lithium-ion Battery Module

Figure 9.6 2U Lithium EBC Front View

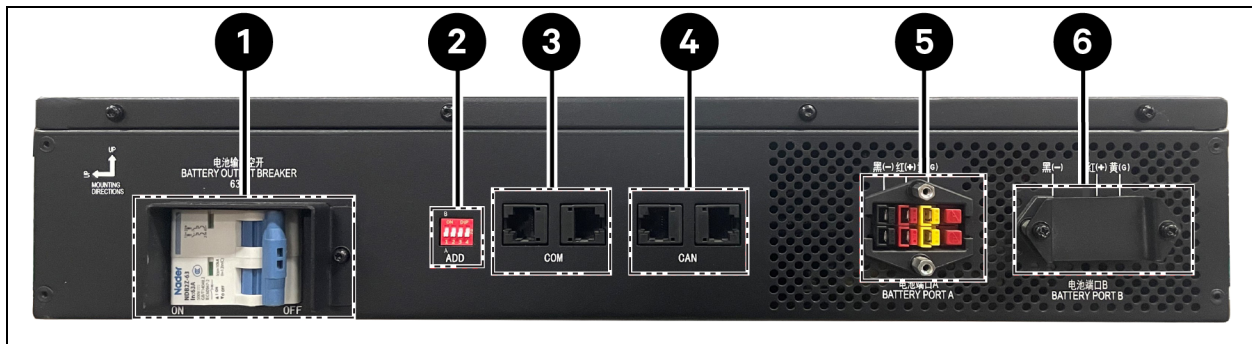

Figure 9.7 2U Lithium EBC Front Panel



Item	Description
1	Battery energy indicators
2	Alarm indicators
3	Status indicators

Figure 9.8 2U Lithium EBC Rear Panel



Item	Description
1	Battery circuit breaker
2	DIP switch (BMS addressing)
3	UPS communication ports
4	CAN communication ports
5	Battery connector port A
6	Battery connector port B

9.7.4 Backup Time of Single UPS Standard Battery Module

For ITA-BCI0020k01 and ITA-BCI0020k02 battery module, the VRLA battery backup time is listed in **Table 9.8** below.

Table 9.8 VRLA Battery Backup Time

Model	Number of battery module	Backup time									
		30 kVA	27 kVA	24 kVA	21 kVA	18 kVA	15 kVA	12 kVA	9 kVA	6 kVA	3 kVA
30 kVA	4	3.0	3.5	4.0	5.0	6.5	8.5	11.5	17.5	31.0	71.5
	8	8.5	10.0	11.5	14.0	17.5	23.0	31.0	45.0	72.0	159.5
	12	15.0	17.5	21.0	25.5	31.5	39.5	52.0	72.0	112.5	255.0
	16	23.0	26.5	31.5	37.0	45.0	56.0	72.0	99.5	161.0	350.5
	20	31.5	36.0	41.5	49.0	58.5	72.0	92.5	129.0	209.0	446.0

Table 9.9 MPL 192V 12Ah Lithium EBC with ITA2 30 kVA 3-Phase UPS Models

Battery String Qty	Load Level									
	100%	90%	80%	70%	60%	50%	40%	30%	20%	10%
	30 kW	27 kW	24 kW	21 kW	18 kW	15 kW	12 kW	9 kW	6 kW	3 kW
2	15	16	18	21	25	30	39	52	78	173
3	22	25	28	32	38	47	59	81	120	260
4	30	34	38	43	52	63	79	109	161	345
5	38	43	48	55	66	78	99	137	202	430
6	47	52	59	67	80	93	119	165	243	515
7	56	62	70	79	94	109	139	193	284	600
8	65	72	80	91	108	125	159	221	325	685

1 string = 2 packs of 12 Ah lithium battery

NOTE: Due to the differences in battery manufacturers and models, as well as the varying lengths of usage time, there will be certain differences in backup time. Therefore, the above data is only for users reference.

NOTE: Table above shows the backup time when the battery performance is good. If the battery performance declines, the actual backup time may not reach the level listed in this table.

Appendices

Appendix A: LCD Parameters Setting

Table A.1 LCD Parameters Setting

Menu	Item	Setting Range	Default Setting
System	Auto restart	Disable, Enable	Enable
	Auto restart delay	0 to 999 seconds	0
	Guaranteed shutdown	Disable, Enable	Disable
	Remote control	Disable, Enable	Enable
	Remote power on delay	0 to 999 seconds	0
	Remote shutdown delay	0 to 999 seconds	0
	LBS select	Disable, Master, Slave	Disable
	IT system compatibility	Disable, Enable	Disable
	Dry contact 1 (Output)	Low battery, On bypass, On battery, UPS fault	Low battery
	Dry contact 2 (Output)	Low battery, On bypass, On battery, UPS fault	UPS fault
	Dry contact 3 (Input)	Battery mode shutdown, Any mode shutdown, Maintain mode	Maintain mode
Dry contact 4 (Input)	Battery mode shutdown, Any mode shutdown, Maintain mode	Maintain mode	
Output	Voltage selection	220 V, 230 V, and 240 V	220 V
	Startup on bypass	Disable, Enable	Disable
	Frequency selection	Auto, BypEna; Auto, BypDisa; 50Hz, BypDisa; 60 Hz, BypDisa	Auto, BypEna
	Inverter sync range	±0.5 Hz, ±1.0 Hz, ±2.0 Hz, ±3.0 Hz, ±4.0 Hz, ±5.0 Hz	±3.0 Hz
	Bypass voltage upper limit	+10%, +15%, +20%	+20%
	Bypass voltage lower limit	-10%, -20%, -30%, -40%	-40%
	Bypass frequency range	±5 Hz, ±10 Hz	±10 Hz
	Run mode	Normal, ECO mode	Normal

Table A.1 LCD Parameters Setting (continued)

Menu	Item	Setting Range	Default Setting	
Output	ECO voltage range	±5%, ±10%, ±15%	±10%	Appear only when the 'Run mode' is set to 'ECO mode'
	ECO frequency range	±1 Hz, ±2 Hz, ±3 Hz	±3 Hz	
	ECO requalification time	5, 15, 30 (min)	5	
Parallel	Voltage selection	220 V, 230 V, 240 V	220 V	
	Frequency selection	Auto, BypEna; Auto, BypDisa; 50Hz, BypDisa; 60Hz, BypDisa	Auto, BypEna	
	Run mode	Normal, ECO mode	Normal	
	Redundant	NO, YES	YES	
	System parallel No.	1 to 4	1	
	Sync parallel parameters	Button	Button	
Battery	Shared battery	Disable, Enable	Disable	
	Local/Parallel battery total Ah	7 to 3000Ah	18 Ah	
	Low battery time	2 to 30 (minutes)	2	
	Battery test interval	Disable, 8 weeks, 12 weeks, 16 weeks, 20 weeks, 26 weeks	Disable	
	Battery test weekday	Sunday, Monday, Tuesday, Wednesday, Thursday, Friday, Saturday	Wednesday	
	Battery test time	MM:SS	00:00	
	Battery series	32, 34, 36, 38, 40	32	
	Discharge protect time	1 to 4320 (minutes)	4320	
	Equal charge enable	NO, YES	NO	
	Temperature compensation	Disable, Enable	Disable	
	Replace battery	Button	Button	
Monitor	Language	English, Chinese	English	
	Date	YYYY-MM-DD	2000-01-01	
	Time	HH:MM:SS	00:00:00	
	Display orientation	Auto-rotate, Horizontal, Vertical	Auto-rotate	
	Audible alarm	Enable, Disable	Enable	
	Intellislot	Velocity, YDN23	Velocity	

Table A.1 LCD Parameters Setting (continued)

Menu	Item	Setting Range	Default Setting
Monitor	UPS comm address	1 to 255	1
	Control port protocol	Modbus, Sensor	Sensor
	Modbus address	1 to 128	1
	IPv4 address	ddd.ddd.ddd.ddd ('d' is a decimal number)	192.168.1.10
	Subnet mask		255.255.255.0
	Gateway address		192.168.1.1
	SNMP NMS address		192.168.1.100
	Change settings password		The password is numeric only and can be set from 0 to 9. The password length is 6

Appendix B: Glossary

Table B.1 Glossary

Term	Abbreviation
AC	Alternating Current
CB	Circuit Breaker
CSA	Cross Sectional Area
DC	Direct Current
DIP	Dual In-line Package
DSP	Digital Signal Processor
EMC	Electromagnetic Compatibility
EMI	Electromagnetic Interference
EOD	End Of Discharge
EPO	Emergency Power Off
I/O	Input/Output
LBS	Load Bus Synchronizer
LCD	Liquid Crystal Display
LED	Light-Emitting Diode
MCB	Miniature Circuit Breaker
NMS	Network Management System
PE	Protective Earth
RCCB	Residual Current Circuit Breaker
RCD	Residual Current Detector
REPO	Remote Emergency Power Off
RFI	Radio Frequency Interference
SCR	Silicon-Controlled Rectifier
SNMP	Simple Network Monitoring Protocol
STS	Static Transfer Switch
UPS	Uninterruptible Power System

Appendix C: Hazardous Substances and Content

Table C.1 Hazardous Substances and Content

Parts	Hazardous substances					
	Plumbum	Hydrargyru	Cadmium	Chrome ⁶⁺	PBB	PBDE
	(Pb)	(Hg)	(Cd)	(Cr (VI))	(PBB)	(PBDE)
Cables	×	○	○	○	○	○
<p>This table is prepared according to the regulations of SJ/T 11364.</p> <p>○ : The content of the hazardous substances in all the average quality materials of the parts is within the limits specified in GB/T 26572.</p> <p>×: The content of the hazardous substances in at least one of the average quality materials of the parts is outside the limits specified in GB/T 26572.</p>						
Applicable scope: Vertiv™ Liebert® ITA2 30 kVA UPS						

Appendix D: Dimension

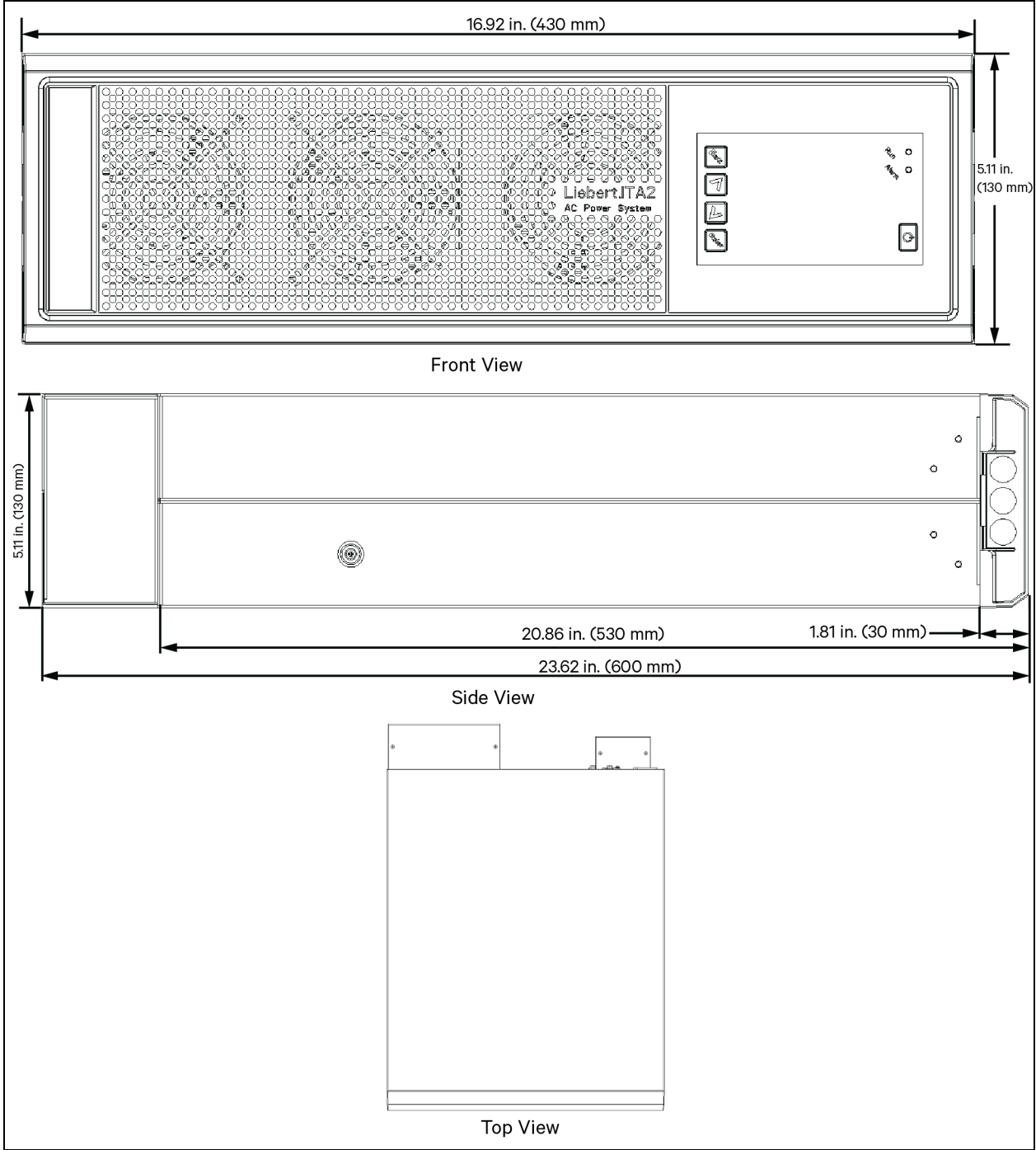

Connect with Vertiv on Social Media



<https://www.facebook.com/vertiv/>



<https://www.instagram.com/vertiv/>



<https://www.linkedin.com/company/vertiv/>



<https://www.x.com/Vertiv/>



Vertiv.com | Vertiv Headquarters, 505 N Cleveland Ave, Westerville, OH 43082 USA

©2026 Vertiv Group Corp. All rights reserved. Vertiv™ and the Vertiv logo are trademarks or registered trademarks of Vertiv Group Corp. All other names and logos referred to are trade names, trademarks or registered trademarks of their respective owners. While every precaution has been taken to ensure accuracy and completeness here, Vertiv Group Corp. assumes no responsibility, and disclaims all liability, for damages resulting from use of this information or for any errors or omissions.

31013769/SL-80251_REVA_02-26