



# Liebert® GXT RT+ UPS

230 V Input, 230 V Output

Installer/User Guide

The information contained in this document is subject to change without notice and may not be suitable for all applications. While every precaution has been taken to ensure the accuracy and completeness of this document, Vertiv assumes no responsibility and disclaims all liability for damages resulting from use of this information or for any errors or omissions. Refer to other local practices or building codes as applicable for the correct methods, tools, and materials to be used in performing procedures not specifically described in this document.

The products covered by this instruction manual are manufactured and/or sold by Vertiv. This document is the property of Vertiv and contains confidential and proprietary information owned by Vertiv. Any copying, use or disclosure of it without the written permission of Vertiv is strictly prohibited.

Names of companies and products are trademarks or registered trademarks of the respective companies. Any questions regarding usage of trademark names should be directed to the original manufacturer.

## Technical Support Site

If you encounter any installation or operational issues with your product, check the pertinent section of this manual to see if the issue can be resolved by following outlined procedures. Visit <https://www.vertiv.com/en-us/support/> for additional assistance.

## Table of Contents

Important Safety Information.....	1
Chapter 1: GXT RT+ Description.....	3
1.1. UPS Features and Available Models.....	3
1.2. External Battery Cabinet.....	3
Chapter 2: Installation and Setup.....	5
2.1. Rear Panel Views.....	5
2.2. Installing the UPS.....	6
2.2.1. Rack Installation.....	6
2.2.2. Tower Installation.....	6
2.3. Setup the UPS.....	6
Chapter 3: Operations.....	9
3.1. Button Operation.....	9
3.2. LCD Panel.....	10
3.3. Audible Alarm.....	13
3.4. LCD Display Wordings Index.....	13
3.5. UPS Setting.....	14
3.6. Operating Mode Description.....	17
3.7. Faults Reference Code.....	18
3.8. Warning Indicators.....	19
Chapter 4: Troubleshooting.....	21

Chapter 5: Storage and Maintenance.....	23
5.1. Operation.....	23
5.2. Storage.....	23
5.3. Battery Replacement for Rack UPS.....	24
Chapter 6: Specifications.....	25
Appendix I: Technical Support.....	29

## Important Safety Information

Comply with all warnings and operating instructions in this manual strictly. Save this manual and carefully read the following instructions before installing the unit. Do not operate this unit before reading all safety information and operating instructions carefully.

## Transportation

Only transport the UPS system in the original packaging to protect against shock and impact.

## Preparation

- Condensation may occur if the UPS system is moved directly from a cold to a warm environment. The UPS system must be absolutely dry before being installed. Please allow at least two hours for the UPS system to acclimate the environment.
- Do not install the UPS system near water or in moist environments.
- Do not install the UPS system where it would be exposed to direct sunlight or near a heater.
- Do not block ventilation holes in the UPS housing.

## Installation

- Do not connect appliances or devices which would overload the UPS system (e.g. laser printers) to the UPS output sockets.
- Place cables in such a way that no one can step on or trip over them.
- Do not connect domestic appliances such as hair dryers to UPS output sockets.
- Connect the UPS system only to an earthed shockproof outlet which must be easily accessible and close to the UPS system.
- Please use only VDE-tested, CE-marked mains cable (e.g. the mains cable of your computer) to connect the UPS system to the building wiring shockproof outlet.
- Please use only VDE-tested, CE-marked power cables to connect the loads to the UPS system.
- When installing the equipment, ensure that the sum of the leakage current of the UPS and the connected devices does not exceed 3.5 mA.

## Operation

- Do not disconnect the mains cable on the UPS system or the building wiring shockproof outlet during operations since this would cancel the protective earthing of the UPS system and of all connected loads.
- The UPS system features its own, internal power source (batteries). The UPS output sockets or output terminal blocks may be electrically live even if the UPS system is not connected to the building wiring outlet.
- In order to fully disconnect the UPS system, first press the OFF/Enter button to disconnect the mains.
- Prevent fluids and foreign objects from entering the inside of the UPS system.

## Maintenance, Service, and Faults

- The UPS system operates with hazardous voltages. Repairs may be carried out only by qualified maintenance personnel.
- Caution - risk of electric shock. Even after the unit is disconnected from the mains (building wiring outlet), components inside the UPS system are still connected to the battery and electrically live and dangerous.
- Before carrying out any kind of service and/or maintenance, disconnect the batteries and verify that no current is present and no hazardous voltage exists in the terminals of high energy capacitors such as BUS-capacitors.
- Only persons that are adequately familiar with batteries and with the required precautionary measures may replace batteries and supervise operations. Unauthorized persons must be kept well away from the batteries.
- Caution - risk of electric shock. The battery circuit is not isolated from the input voltage. Hazardous voltages may occur between the battery terminals and the ground. Before touching, please verify that no voltage is present!
- Batteries may cause electric shock and have a high short-circuit current. Please take the precautionary measures specified below and any other measures necessary when working with batteries:
  - » Remove wristwatches, rings and other metal objects
  - » Use only tools with insulated grips and handles.
- When changing batteries, install the same number and same type of batteries.
- Do not attempt to dispose of batteries by burning them. This could cause battery explosion.
- Recycle or dispose of batteries properly according to local regulations.
- Do not open or destroy batteries. Escaping electrolyte can cause injury to the skin and eyes. It may be toxic.
- Please replace fuses only with the same type and amperage in order to avoid fire hazards.
- Do not dismantle the UPS system.

# Chapter 1: GXT RT+ Description

## 1.1. UPS Features and Available Models

The GXT RT+ includes the following features. [Table 1-1](#) below, lists the available models and power ratings.

- Input power factor of 0.9.
- Automatic bypass, allowing the load to transfer to the mains in case of an overload or internal fault.
- Optional tower or rack installation to meet varying installation requirements.
- Adapts to areas with unstable power-mains supply via high-frequency double-conversion topology structure, with high input-power factor, wide input-voltage range, and output immune to grid interference.
- ECO power-supply mode helps you save the maximum amount of energy.

**Table 1-1 UPS Models and Power Ratings**

MODEL NUMBER	NOMINAL POWER RATING
GXTRT-1000IRT2UXL	1000 VA/900 W
GXTRT-1500IRT2UXL	1500 VA/1350 W
GXTRT-2000IRT2UXL	2000 VA/1800 W
GXTRT-3000IRT2UXL	3000 VA/2700 W

## 1.2. External Battery Cabinet

Optional external battery cabinets are available for the UPS. [Table 1-2](#) below to determine which EBC works with your system. Only connect an external battery of the same voltage and chemistry to the UPS.

**Table 1-2 External Battery Cabinet**

EBC MODEL NUMBER	COMPATIBLE UPS MODELS
GXTRT-EBC24VRT2U	GXTRT-1000IRT2UXL
GXTRT-EBC36VRT2U	GXTRT-1500IRT2UXL
GXTRT-EBC48VRT2U	GXTRT-2000IRT2UXL
GXTRT-EBC72VRT2U	GXTRT-3000IRT2UXL

This page is intentionally left blank.



# Chapter 2: Installation and Setup

Before installation, please inspect the unit for shipping damage. Be sure that nothing inside the package is damaged. Please keep the original package in a safe place for future use.

The UPS should be installed in an area away from vibration, dust, humidity, high temperature, flammable liquids, gases, corrosive and conductive contaminants. Install the UPS indoors in a clean environment, where it is away from windows and doors. Maintain minimum of 300 mm clearance on the front and rear panels of the UPS.

## 2.1. Rear Panel Views

Figure 2-1 Rear Panels

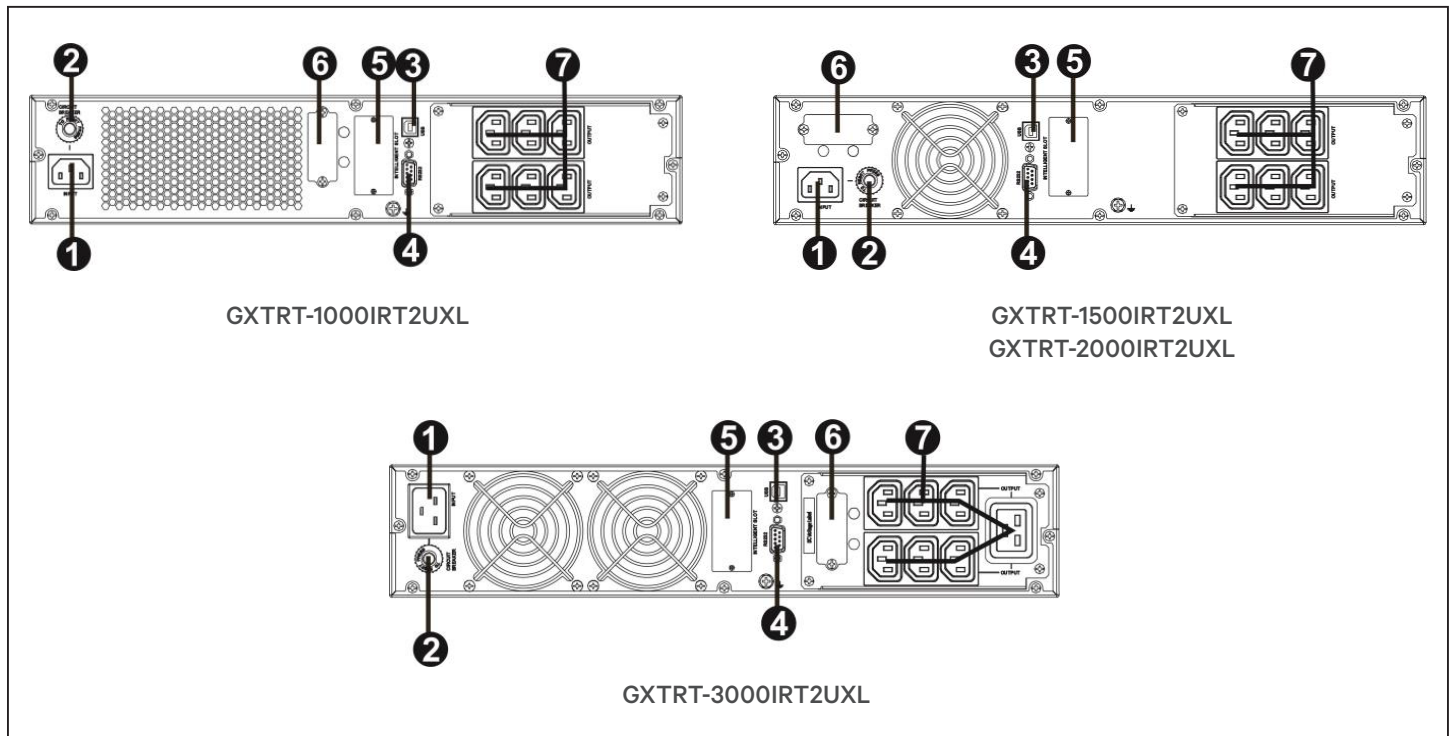

ITEM	DESCRIPTION
1	AC input
2	Input circuit breaker
3	USB communication port
4	RS 232 communication port
5	SNMP intelligent slot (option)
6	External battery connection
7	Output receptacles

## 2.2. Installing the UPS

### 2.2.1. Rack Installation

This UPS can be mounted in a 19" rack chassis as shown in below.

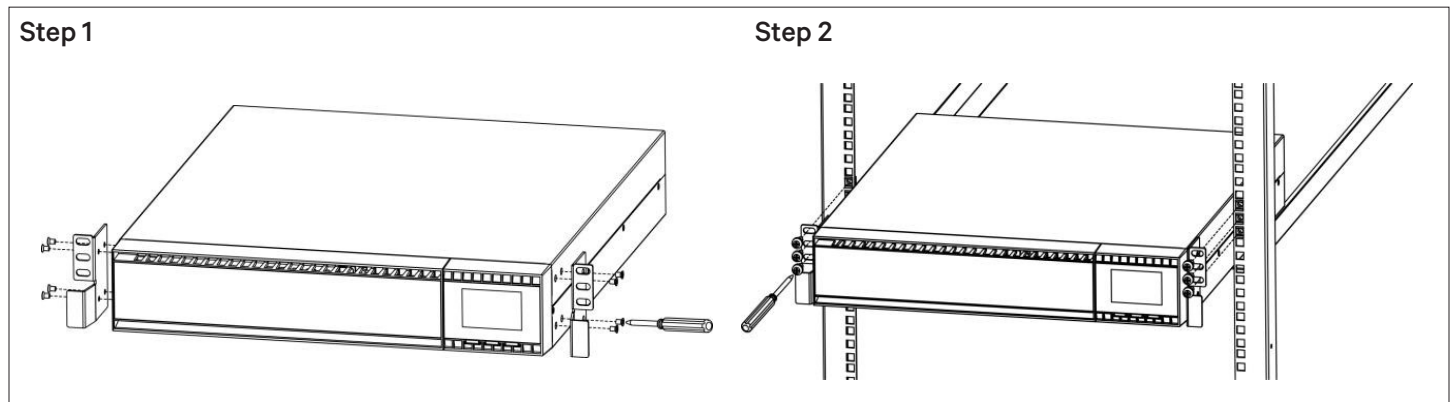

### 2.2.2. Tower Installation

To install the UPS as a tower:

1. Take the support bases out of the accessories box.
2. If optional, external battery cabinets will be connected, take out the spacers shipped with each battery cabinet.
3. Connect the spacers and the support bases. Each GXT RT+ requires 2 support bases, one in the front and one in the rear.
4. Place the GXT RT+ and any battery cabinets on the 2 support bases.

## 2.3. Setup the UPS

### Step 1: Connect battery wires

If using External Battery Cabinets (EBCs), verify that the EBC breaker is in the “Off” position. Then, connect one end of the supplied EBC cable to the UPS and one end to the battery cabinet. If connecting more than one external battery, connect one end of the external battery cable to the second connector on the battery cabinet, then connect the other end to the next battery cabinet.

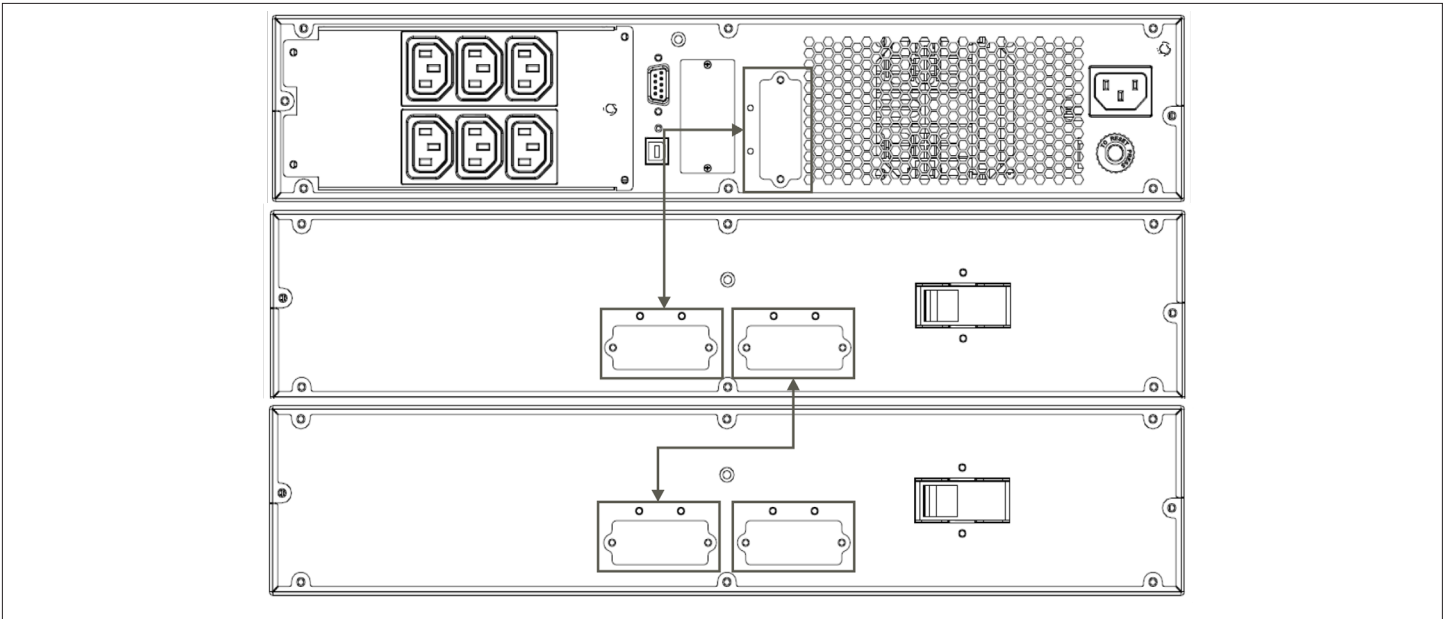

**Step 2: UPS input connection**

Plug the UPS into a two-pole, three-wire, grounded receptacle only. Avoid using extension cords. The power cord is supplied in the UPS package. Use an upstream circuit breaker rated for your model based on the below table.

MODEL NUMBER	RECOMMENDED CIRCUIT BREAKER	RECOMMENDED POWER CABLE WIRE SIZE
GXTRT-1000IRT2UXL	10 A	18 AWG
GXTRT-1500IRT2UXL		
GXTRT-2000IRT2UXL		
GXTRT-3000IRT2UXL	20 A	14 AWG

**Step 3: UPS output connection**

Connect devices to be protected to the outlets.

**Step 4: Communication connection**

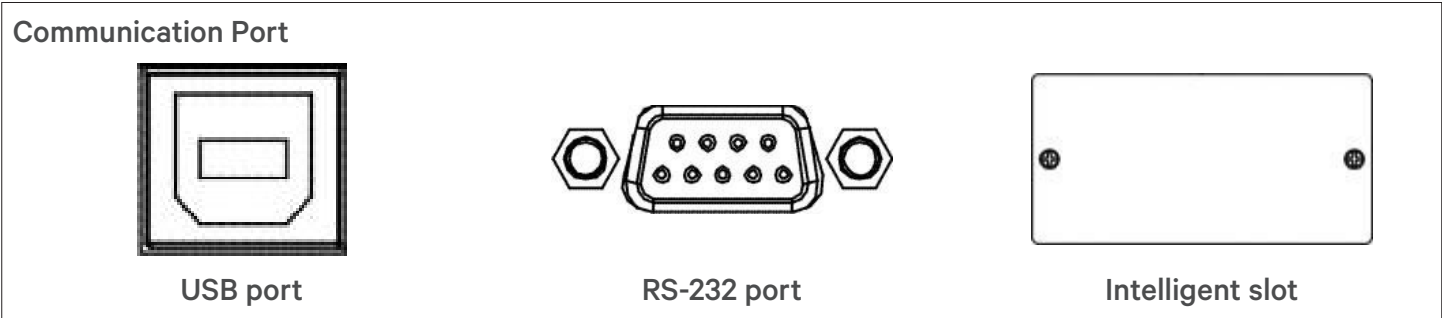

To allow for unattended UPS shutdown/start up and status monitoring, connect the communication cable one end to the USB/RS-232 port and the other to the communication port of your PC. With the monitoring software installed, you can schedule UPS shutdown/start up and monitor UPS status through your PC.

The UPS is equipped with an intelligent slot for either an SNMP or AS400 card. When either an SNMP or AS400 card is installed, it will provide advanced communication and monitoring options.

**Note: The USB port and RS-232 port cannot operate at the same time.**

### **Step 5: Turn on the UPS**

Press the ON/Mute button on the front panel for two seconds to power on the UPS.

**Note: The battery charges fully during the first five hours of normal operation. Do not expect full battery run capability during this initial charge period.**

### **Step 6: Install software**

For optimal computer system protection, install UPS monitoring software to fully configure UPS shutdown of the attached computer. Follow the steps below to download and install monitoring software from the Internet:

1. Go to the website <http://vertiv.com/Liebert-GXT-RT-Plus>.
2. Select the appropriate ViewPower download link for the OS of the attached computer.
3. Follow the on screen instructions to install the software.
4. When your computer restarts, the monitoring software will appear as an orange plug icon located in the system tray, near the clock.

# Chapter 3: Operations

## 3.1. Button Operation

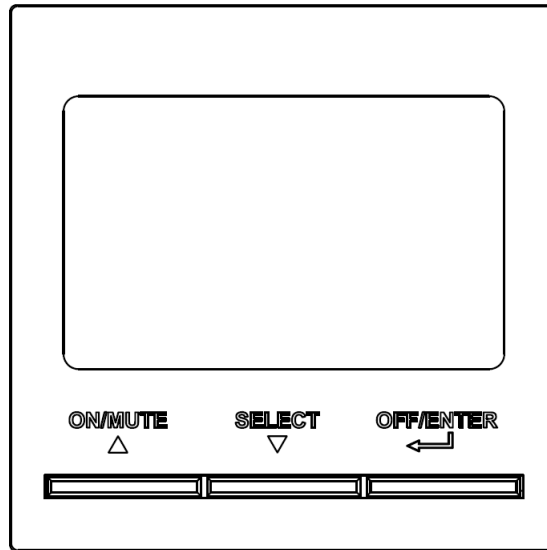





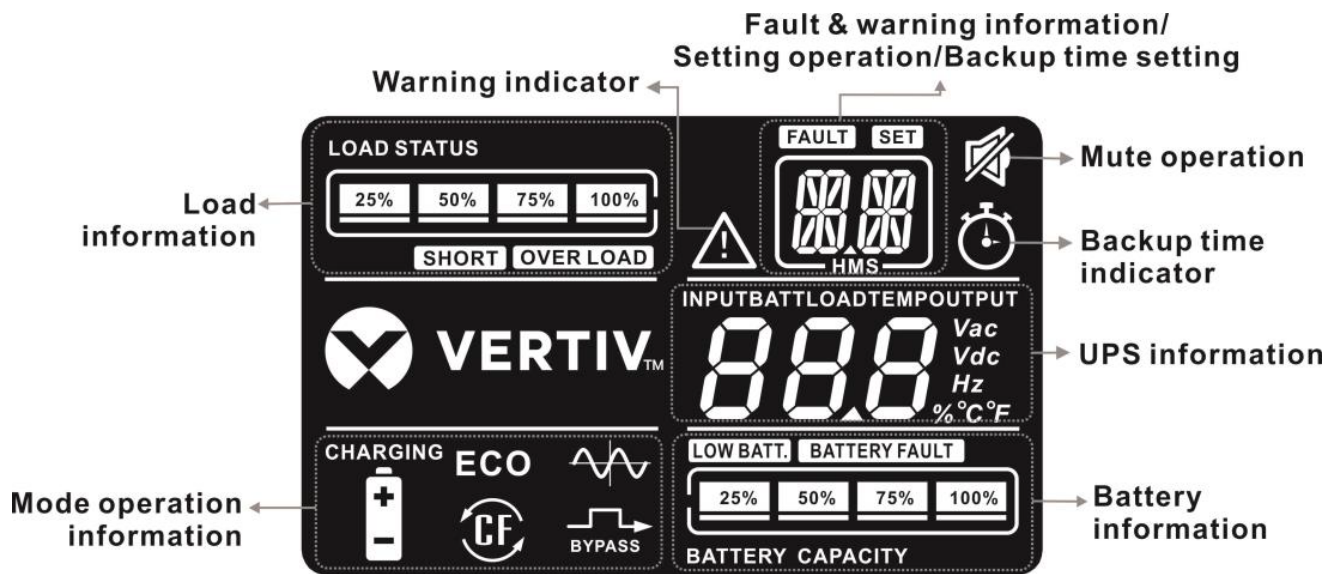

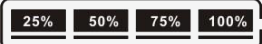

BUTTON	FUNCTION
ON/MUTE/UP	<ul style="list-style-type: none"> <li>• Turn on the UPS: Press and hold ON/Mute button for at least 2 seconds to turn on the UPS.</li> <li>• Mute the alarm: When the UPS is on battery mode, press and hold this button for at least 5 seconds to disable or enable the current active audible alarm. The audible alarm will automatically enable if another warning or error occurs.</li> <li>• Up key: Press this button to display previous selection in UPS setting mode.</li> <li>• Switch to UPS self-test mode: Press and hold ON/Mute button for 5 seconds to enter UPS self-testing while in AC mode, ECO mode, or converter mode.</li> </ul>
OFF/ENTER	<ul style="list-style-type: none"> <li>• Turn off the UPS: Press and hold this button at least 2 seconds to turn off the UPS. UPS will be in standby mode under power normal or transfer to Bypass mode if the Bypass enable setting by pressing this button.</li> <li>• Confirm selection key: Press this button to confirm selection in UPS setting mode.</li> </ul>
SELECT/DOWN	<ul style="list-style-type: none"> <li>• Switch LCD message: Press this button to change the LCD message for input voltage, input frequency, battery voltage, output voltage and output frequency.</li> <li>• Setting mode: Press and hold this button for 5 seconds to enter UPS setting mode when UPS is in standby mode or bypass mode.</li> <li>• Down key: Press this button to display next selection in UPS setting mode.</li> </ul>
ON/MUTE/UP + SELECT/DOWN Buttons	<ul style="list-style-type: none"> <li>• Switch to bypass mode: When the main power is normal, press ON/Mute and Select buttons simultaneously for 5 seconds. Then, UPS will enter to bypass mode if the input voltage is within the acceptable range. This is the normal way to switch to bypass. If desired, the UPS can also be set to switch to bypass when switched off instead of turning off all outputs. See Setting 05: Bypass enable/disable when UPS is off, on page 15 for details.</li> </ul>

## 3.2. LCD Panel



DISPLAY	FUNCTION
<b>Remaining backup time setting and information</b>	
	Illuminated when UPS is in battery backup mode.
	Indicates the backup time remaining in number of hours, minutes, or seconds. H: hours, M: minute, S: second
<b>Setting operation</b>	
	Shows the setting number currently selected when in settings menu.
<b>Fault &amp; warning information</b>	
	A warning or fault is occurring.
	Shows the active warning or fault code. The codes are listed in detail in <a href="#">Section 3.5 UPS Setting</a> .

DISPLAY	FUNCTION
<b>Mute operation</b>	
	The audible alarm is disabled when this is lit.
<b>UPS information</b>	
<p>INPUT BATT LOAD TEMP OUTPUT</p> 	Shows the currently selected status from the following list: <ul style="list-style-type: none"> <li>- Vac input voltage</li> <li>- Vac output voltage</li> <li>- Vdc battery voltage</li> <li>- Hz frequency</li> <li>- % load level</li> <li>- °C/°F internal temperature</li> </ul>
<b>Load information</b>	
<p>LOAD STATUS</p> 	Displays the output load level by showing 1- 4 bars: <ul style="list-style-type: none"> <li>1 bar - 0-25%</li> <li>2 bars - 26-50%</li> <li>3 bars - 51-75%</li> <li>4 bars - 76-100%</li> </ul>
<b>OVER LOAD</b>	The output is overloaded.
<b>SHORT</b>	The output is shorted.
<b>Mode operation information</b>	
	The UPS is in online mode.
	The UPS is in battery mode.
 <b>BYPASS</b>	The UPS is in bypass mode.
<b>ECO</b>	The UPS is in ECO mode.

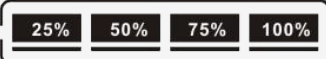











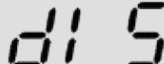
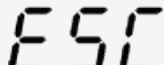

DISPLAY	FUNCTION
	<p>The UPS is in frequency converter mode.</p>
<p><b>CHARGING</b></p> 	<p>The UPS is charging the battery.</p>
<p><b>Battery information</b></p>	
 <p><b>BATTERY CAPACITY</b></p>	<p>Displays the battery capacity by showing 1- 4 bars:</p> <p>1 bar - 0-25%</p> <p>2 bars - 26-50%</p> <p>3 bars - 51-75%</p> <p>4 bars - 76-100%</p>
<p><b>BATTERY FAULT</b></p>	<p>The battery has faulted.</p>
<p><b>LOW BATT.</b></p>	<p>Shows that the battery level is low.</p>



### 3.3. Audible Alarm

Condition	Audible Alarm
Bypass Mode	Sounds every 10 seconds
Battery Mode	Sounds every 4 seconds
Low Battery	Sounds every second
Overload	Sounds twice every second
Fault	Continuously sounds

### 3.4. LCD Display Wordings Index

LCD AREA	DISPLAY CONTENT	ABBREVIATION	MEANING
		ENA	Enable
		DIS	Disable
		ESC	Escape
		b.L	Low battery
		O.L	Overload
		N.C	Battery is not connected
		O.C	Overcharge
		C.H	Charger
		b.F	Battery fault
		b.V	Bypass voltage out of range
		W.T	Waiting
		F.U	Bypass frequency unstable
		E.E	EEPROM error

### 3.5. UPS Setting

To adjust UPS settings, switch the UPS to standby mode and press and hold the settings button for 5 seconds to enter the settings menu. Use the arrow keys to browse to the desired setting and then press enter to select it. Once selected, use the arrow keys to select the desired settings value. Browse to setting 00, ESC and select ESC to leave the menu.

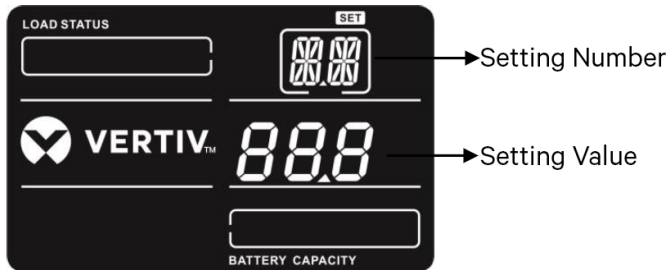

There are two numbers shown when browsing the UPS setting menu.

The top number is for the setting number. Refer to the table below for details of each setting.

The bottom number is the setting option or value for each setting number.

#### 01: Output voltage setting

INTERFACE	SETTING
	<p>You may choose the following output voltages:</p> <p><b>220:</b> output voltage is 220 Vac  <b>230:</b> output voltage is 230 Vac (Default)  <b>240:</b> output voltage is 240 Vac</p>

#### 02: Frequency Converter enable/disable

INTERFACE	SETTING
	<p>Enable or disable frequency converter mode.</p> <p><b>CF ENA:</b> converter mode enable  <b>CF DIS:</b> converter mode disable (Default)</p>

### 03: Output frequency setting

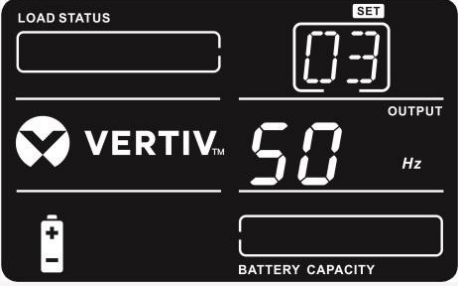
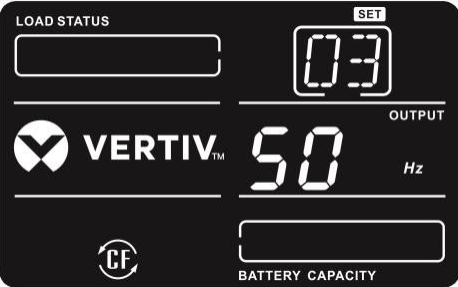
INTERFACE	SETTING
	<p>By default, the following output frequencies can be set on battery mode. The battery indicator will be shown as in the top image to the left.</p> <p>50: output frequency is 50 Hz (Default) 60: output frequency is 60 Hz</p>
	<p>If frequency converter mode is enabled, the following output frequencies can be selected. The CF symbol will be shown as in the bottom image to the left.</p> <p>50: output frequency is 50 Hz (Default) 60: output frequency is 60 Hz</p>

### 04: ECO enable/disable

INTERFACE	SETTING
	<p>Enable or disable ECO mode.</p> <p><b>ENA:</b> ECO mode enabled <b>DIS:</b> ECO mode disabled (Default)</p>

### 05: Bypass enable/disable when UPS is off

INTERFACE	SETTING
	<p>Enable or disable Bypass when the UPS is off.</p> <p><b>ENA:</b> Bypass enable <b>DIS:</b> Bypass disable (Default)</p>

## 06: Backup time setting

INTERFACE	SETTING
	<p>Sets the amount of backup time on battery mode for general outlets before power is removed.</p> <p><b>0-998:</b> setting the backup time in minutes from 0-998 in battery mode.</p> <p><b>0:</b> When setting as “0”, the backup time will be only 10 seconds.</p> <p><b>999:</b> When setting as “999”, the backup time setting will be disabled. (default)</p>

## 07: Battery total AH setting

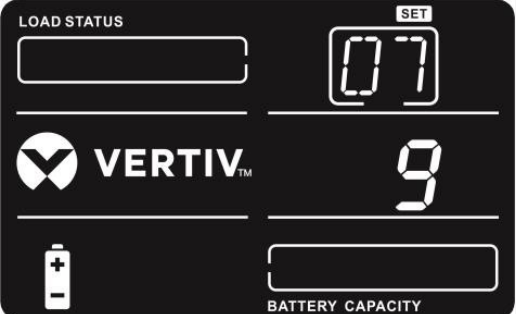
INTERFACE	SETTING
	<p>Set up the battery total AH of the UPS. (unit: AH)</p> <p>7-999: sets the total battery capacity from 7-999 in AH.</p> <p>Please set the correct battery capacity if EBCs are connected.</p> <p>Each GXT RT+ EBC adds 18 AH.</p>

## 00: Exit setting

INTERFACE	SETTING
	<p><b>ESC:</b> Exit the setting menu.</p>

### 3.6. Operating Mode Description

OPERATING MODE	DESCRIPTION	LCD DISPLAY
Turn on	When pressing the “ON/MUTE” button, if battery voltage is within acceptable range, “ON” will flash until the UPS is turned on.	
Online mode	When the input voltage is within acceptable range, UPS will provide pure and stable AC power to output. The UPS will also charge the battery in online mode.	
ECO mode	Energy saving mode: When the input voltage is within voltage regulation range, UPS will bypass input voltage to the output to save energy.	
Frequency Converter mode	When input frequency is within 40 Hz to 70Hz, the UPS can be set at a constant output frequency, 50 Hz or 60 Hz. The UPS will still charge battery under this mode.	
Battery mode	When the input voltage is outside the acceptable range, the UPS will provide backup power from the battery and the alarm will sound every 4 seconds.	

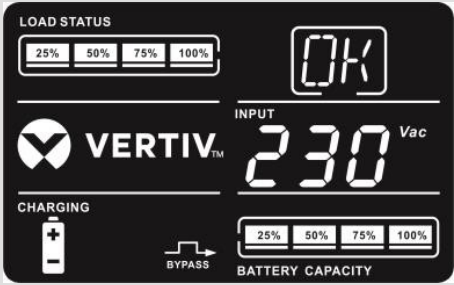
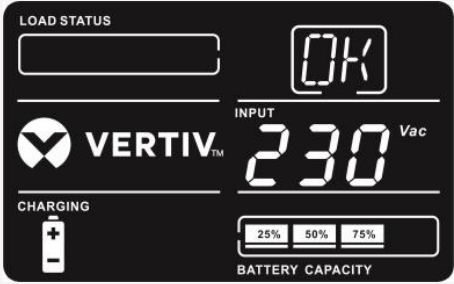
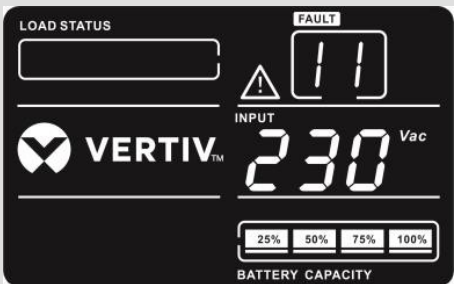









OPERATING MODE	DESCRIPTION	LCD DISPLAY
Bypass mode	When input voltage is within the acceptable range but the UPS is overloaded, UPS will enter bypass mode or bypass mode can be set by front panel. The alarm will sound every 10 seconds.	
Standby mode	UPS output is off, but the battery is still charged as needed.	
Fault mode	The UPS is in fault mode when no output power can be supplied from the UPS and the fault icon and number are displayed on the LCD display. The alarm will sound continuously.	





### 3.7. Faults Reference Code

FAULT EVENT	FAULT CODE	FAULT ICON
Bus start fail	01	X
Bus over	02	X
Bus under	03	X
Bus unbalance	04	X
Bus short	05	X
Inverter soft start fail	11	X
Inverter voltage high	12	X

FAULT EVENT	FAULT CODE	FAULT ICON
Inverter voltage Low	13	X
Inverter output short	14	<b>SHORT</b>
Battery voltage too high	27	<b>BATTERY FAULT</b>
Battery voltage too low	28	<b>BATTERY FAULT</b>
Over temperature	41	X
Over load	43	<b>OVER LOAD</b>
Charger failure	45	X

### 3.8. Warning Indicators









WARNING	INDICATOR		ALARM
	WORD	ICON (FLASHING)	
Low battery	b.L	 <b>LOW BATT.</b>	Sounds every second
Over load	O.L	 <b>OVER LOAD</b>	Sounds twice every second
Battery is not connected	N.C	 	Sounds every second
Overcharge	O.C	 	Sounds every second
Waiting	W.T		Sounds every second
Charger failure	C.H		Sounds every second
Bypass voltage out of range	b.V	  <b>BYPASS</b>	Sounds every second

WARNING	INDICATOR		ALARM
	WORD	ICON (FLASHING)	
Battery fault	b.F	 	Sounds every second
Bypass frequency unstable	F.U		Sounds every second
EEPROM error	E.E		Sounds every second



## Chapter 4: Troubleshooting

If the UPS system does not operate correctly, please use the table below to resolve the problem.



SYMPTOM	POSSIBLE CAUSE	REMEDY
No indication and alarm even though the mains is normal	The AC input power is not connected well	Check if the input power cord is firmly connected to the mains
	The AC input is not connected to the UPS output	Plug the AC input power cord to AC input correctly
The icon  and  flashing on LCD display and alarm is sounding every second	The external or internal battery is incorrectly connected	Check if all batteries are connected well
Fault code is shown as 27 and the icon  is lighting on LCD display and alarm is continuously sounding	Battery voltage is too high or the charger has faulted	Contact Vertiv
Fault code is shown as 28 and the icon  is lighting on LCD display and alarm is continuously sounding	Battery voltage is too low or the charger has faulted	Contact Vertiv
The icon  and  is flashing on LCD display and alarm is sounding twice every second	UPS is overloaded	Remove excess loads from UPS output
	UPS is overloaded. Devices connected to the UPS are fed directly by the electrical network via the Bypass.	Remove excess loads from UPS output
	After repetitive overloads, the UPS is locked in the Bypass mode. Connected devices are fed directly by the mains	Remove excess loads from UPS output first. Then shut down the UPS and restart it
Fault code is shown as 43 and The icon  is lighting on LCD display and alarm is continuously sounding	The UPS shut down automatically because of overload at the UPS output	Remove excess loads from UPS output and restart it
Fault code is shown as 14 and the icon  is lighting on LCD display alarm is continuously sounding	The UPS shut down automatically because short circuit occurs on the UPS output	Check output wiring and if connected devices are in short circuit status
Fault code is shown as 1, 2, 3, 4, 11, 12, 13, 41 and 45 on LCD display and alarm is continuously sound	A UPS internal fault has occurred. There are two possible results: 1. The load is still supplied, but directly from AC power via bypass. 2. The load is no longer supplied by power.	Contact Vertiv
Battery backup time is shorter than nominal value	Batteries are not fully charged	Charge the batteries for at least 5 hours and then check the capacity. If the problem still persists, consult Vertiv
	Batteries defect	Contact Vertiv to replace the battery
Fault code 05 is shown on LCD display. At the same time, the alarm is continuously sounding and the output is off	A UPS internal fault has occurred and BUS is short circuited	Consult Vertiv. If the UPS power is on again before repair, the DC/DC mosfet will damage

This page is intentionally left blank.

# Chapter 5: Storage and Maintenance

## 5.1. Operation

The UPS system contains no user-serviceable parts. If the battery service life (3 ~ 5 years at 25 °C ambient temperature) has been exceeded, the batteries must be replaced. In this case, please contact Vertiv.

 ♻️  ⊘	Be sure to deliver the spent battery to a recycling facility or ship it to your dealer in the replacement battery packing material.
---	---

## 5.2. Storage

Before storing, charge the UPS for at least 5 hours. Store the UPS covered and upright in a cool, dry location. During storage, recharge the battery in accordance with the following table:

STORAGE TEMPERATURE	RECHARGE FREQUENCY	CHARGING DURATION
-25 °C - 40 °C	Every 3 months	1-2 hours
40 °C - 45 °C	Every 2 months	1-2 hours

## 5.3. Battery Replacement for Rack UPS

**NOTICE:** This UPS is equipped with hot swappable internal batteries that the user can replace without shutting down the UPS or connected loads. Replacement is a safe procedure, isolated from electrical hazards.

**CAUTION!!** Read all warnings, cautions, and notes before replacing batteries.

**Note:** Upon battery disconnection, equipment is not protected from power outages.

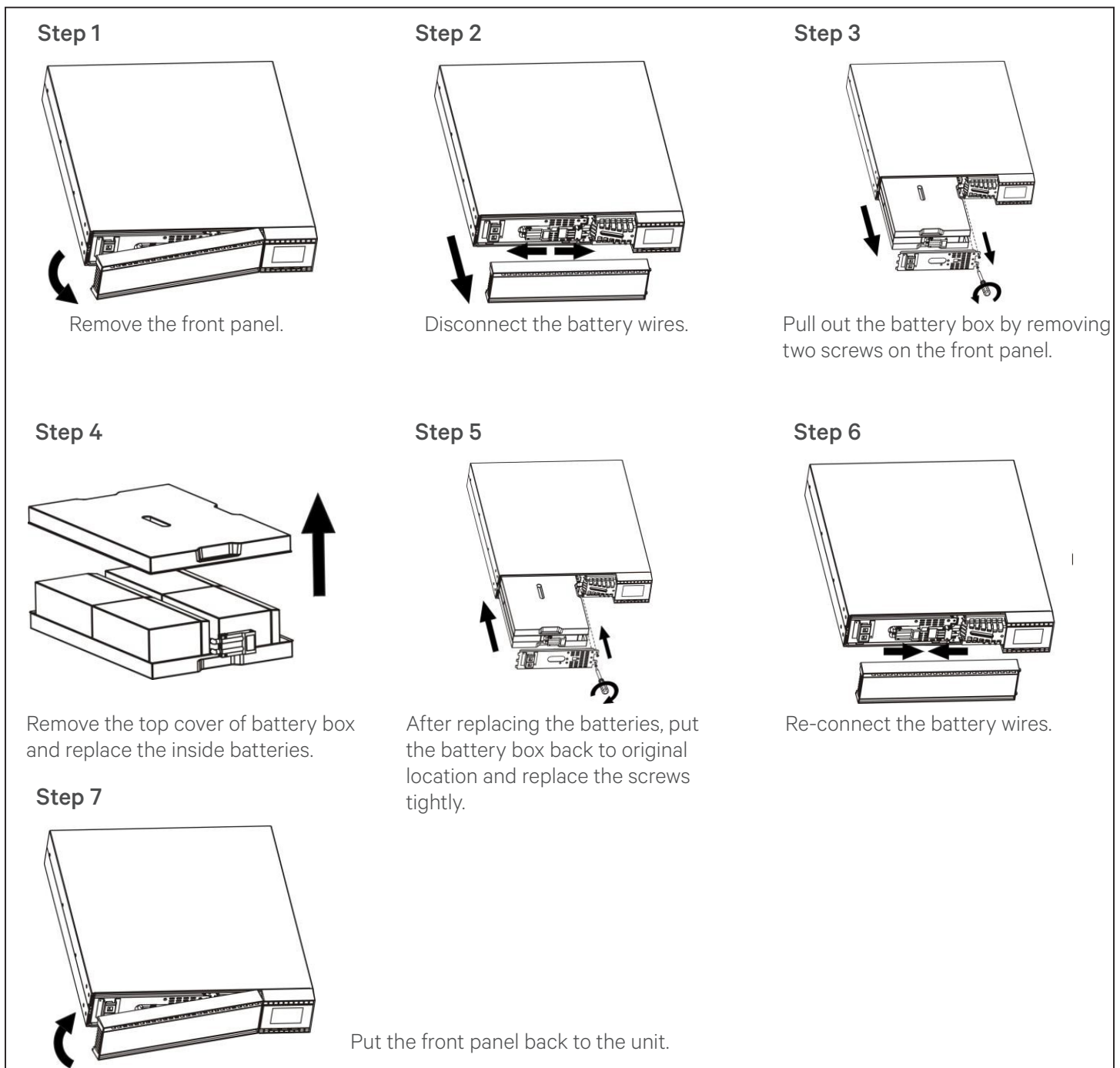

# Chapter 6: Specifications

**Table 6-1 UPS Specifications**

CAPACITY		1000 VA/ 900 W	1500 VA/ 1350 W	2000 VA/ 1800 W	3000 VA/ 2700 W
GXTRT-		1000IRT2UXL	1500IRT2UXL	2000IRT2UXL	3000IRT2UXL
<b>INPUT</b>					
Voltage Range	Low Line Transfer	180 VAC / 160 VAC / 140 VAC / 120 VAC ± 5% (Ambient Temp. < 35 °C) (Based on load percentage 100% - 80% / 80% - 70% / 70% - 60% / 60% - 0%)			
	Low Line Comeback	195 VAC / 175 VAC / 155 VAC / 135 VAC ± 5% (Ambient Temp. < 35 °C) (Based on load percentage 100% - 80% / 80% - 70% / 70% - 60% / 60% - 0%)			
	High Line Transfer	300 VAC ± 5 %			
	High Line Comeback	290 VAC ± 5 %			
Frequency Range		40 Hz ~ 70 Hz			
Phase		Single phase with ground			
Power Factor		0.95 @ nominal input voltage			
<b>OUTPUT</b>					
Output Voltage		220/230/240 VAC			
Output Power Factor		0.9			
AC Voltage Regulation		± 1% (Batt. Mode)			
Frequency Range		47 ~ 53 Hz or 57 ~ 63 Hz (Synchronized Range)			
Frequency Range (Batt. Mode)		50 Hz ± 0.5% or 60 Hz ± 0.5%			
Overload in Online Mode		Ambient Temp. < 35 °C: < 105%: Operate continuously 105% - 110%: Transfer to bypass after 10 minutes 110% - 130%: Transfer to bypass after 1 minute > 130%: Transfer to bypass after 3 seconds Ambient Temp. > 35 °C: Derate above times 50%			
Overload in Battery Mode		Ambient Temp. < 35 °C: < 105%: Operate continuously 105% - 110%: UPS shuts down after 10 minutes 110% - 130%: UPS shuts down after 1 minute > 130%: UPS shuts down after 3 seconds Ambient Temp. > 35 °C: Derate above times 50%			
Overload in bypass Mode		< 110%: Operate continuously 110% - 120%: UPS shuts down after 30 minutes 120% - 130%: UPS shuts down after 10 minutes 130% - 150%: UPS shuts down after 1 minute > 150%: UPS shuts down immediately			
Transfer Time	AC Mode to Batt. Mode	Zero			
	Inverter to Bypass	4 ms (Typical)			
Waveform		Pure Sinewave			
<b>EFFICIENCY</b>					
Online Mode		88%	88%	89%	90%
Battery Mode		83%	84%	87%	88%

**Table 6-1 UPS Specifications (continued)**

CAPACITY	1000 VA/ 900 W	1500 VA/ 1350 W	2000 VA/ 1800 W	3000 VA/ 2700 W
GXTRT-	1000IRT2UXL	1500IRT2UXL	2000IRT2UXL	3000IRT2UXL
<b>BATTERY</b>				
Battery Type	Valve-regulated, non-spillable, lead acid			
Quantity x Voltage x Rating	2 x 12V x 9Ah	3 x 12V x 9Ah	4 x 12V x 9Ah	6 x 12V x 9Ah
Recharge Time	4 hours recover to 90% capacity (Typical)			
Charging Current	1.0 A (max.)			
Charging Voltage	27.2 VDC ± 1%	40.9 VDC ± 1%	54.4 VDC ± 1%	81.7 VDC ± 1%
<b>PHYSICAL</b>				
Unit Dimensions D X W X H (mm)	310 x 438 x 86	410 x 438 x 86		630 x 438 x 86
Unit Weight (kgs)	11.0	15.9	18.2	26.6
Shipping Dimensions D X W X H (mm)	600 x 500 x 240	700 x 565 x 240		760 x 600 x 240
Shipping Weight (kgs)	16.3	22.3	24.7	34.1
<b>MANAGEMENT</b>				
Smart RS-232 or USB	Supports Windows® 2003/XP/Vista/2008/7/8/2012/10/2016/2019, Linux, and MAC			
Optional SNMP	Power management from SNMP manager and web browser			
<b>AGENCY</b>				
Safety	CE Mark; IEC/EN 62040-1: 2014			
EMI	IEC/EN 62040-2 (Cat. C1): 2006 + AC: 2006 (Class A)			
Surge Immunity	EN 61000-4-5: 2005 Class 2 L-N, Class 3 L-G			
Transportation	ISTA 2A			
<b>ENVIRONMENTAL REQUIREMENTS</b>				
Operating Temperature, °C	0 to 50*			
Storage Temperature, °C	-20 to 50			
Operating Relative Humidity	20% to 90%, non-condensing			
Storage Relative Humidity	10% to 90%, non-condensing			
Operating Elevation	2000 m without derating. Between 2000 and 3000 m, derate 1% for every 100m. Operation above 3000 m is not supported.			
Noise Level	55 dBA Max @ 1 Meter			
<p>*To extend battery life, it is recommended to use the UPS in the range of 15 - 25 °C.  The threshold of low line transfer and low line comeback is increased when Ambient Temp. is 35 - 50 °C.  70% derating of output when Ambient Temp. is 40 - 50 °C.  The overload capacity is decreased when Ambient Temp. is 40 - 50 °C.  Transfer to bypass mode and show temp. alarm when Ambient Temp. &gt; 50 °C and transfer back to online mode when Ambient Temp. &lt; 40 °C.</p>				

**Table 6-2 EBC Specifications**

MODEL NUMBER	GXTRT-	EBC24VRT2U	EBC36VRT2U	EBC48VRT2U	EBC72VRT2U
USED W/UPS MODEL	GXTRT-	1000IRT2UXL	1500IRT2UXL	2000IRT2UXL	3000IRT2UXL
<b>PHYSICAL</b>					
Unit Dimensions D X W X H (mm)		410 x 438 x 86		510 x 438 x 86	630 x 438 x 86
Unit Weight (kgs)		16.2	21.2	28.6	40.8
Shipping Dimensions D X W X H (mm)		600 x 500 x 240		700 x 565 x 240	760 x 600 x 240
Shipping Weight (kgs)		21.1	26.1	34.3	47.2
<b>BATTERY</b>					
Battery Type		Valve-regulated, non-spillable, lead acid			
Battery Configuration		Two parallel strings of two 12V/9Ah batteries in series.	Two parallel strings of three 12V/9Ah batteries in series.	Two parallel strings of four 12V/9Ah batteries in series.	Two parallel strings of six 12V/9Ah batteries in series.
Charging Voltage		27.2 VDC ± 1%	40.9 VDC ± 1%	54.4 VDC ± 1%	81.7 VDC ± 1%
<b>AGENCY</b>					
Safety		CE Mark; IEC/EN 62040-1: 2014			
EMI		IEC/EN 62040-2 (Cat. C1): 2006 + AC: 2006 (Class A)			
Surge Immunity		EN 61000-4-5: 2005 Class 2 L-N, Class 3 L-G			
Transportation		ISTA 2A			
<b>ENVIRONMENTAL REQUIREMENTS</b>					
Operating Temperature, °C		0 to 50			
Storage Temperature, °C		-20 to 50			
Operating Relative Humidity		20% to 90%, non-condensing			
Storage Relative Humidity		10% to 90%, non-condensing			
Operating Elevation		2000 m without derating. Between 2000 and 3000 m, derate 1% for every 100 m. Operation above 3000 m is not supported.			

**Table 6-3 GXTRT-1000IRT2UXL Runtime Table**  
See Note 1

LOAD			INTERNAL BATTERY ONLY	NUMBER OF EXTERNAL BATTERY CABINETS					
				1	2	3	4	5	6
%	VA	W	Minutes						
25	250	225	19	69	129	184	240	291	335
50	500	450	9	38	70	103	139	176	213
69	690	621	5.3	26	48	72	95	120	145
75	750	675	5	10	10	10	10	10	10
80	800	720	3.5	3.5	3.5	3.5	3.5	3.5	3.5
90	900	810	3.5	3.5	3.5	3.5	3.5	3.5	3.5
100	1000	900	3.1	3.5	3.5	3.5	3.5	3.5	3.5

**Table 6-4 GXTRT-1500IRT2UXL Runtime Table**  
See Note 1

LOAD			INTERNAL BATTERY ONLY	NUMBER OF EXTERNAL BATTERY CABINETS					
				1	2	3	4	5	6
%	VA	W	Minutes						
25	375	338	21	76	143	203	261	321	380
50	750	675	9	38.5	72	106	143	180	215
69	1035	932	5.5	26.2	48	72	97	123	150
75	1125	1013	5.2	10	10	10	10	10	10
80	1200	1080	3.5	3.5	3.5	3.5	3.5	3.5	3.5
90	1350	1215	3.5	3.5	3.5	3.5	3.5	3.5	3.5
100	1500	1350	3.2	3.5	3.5	3.5	3.5	3.5	3.5

**Table 6-5 GXTRT-2000IRT2UXL Runtime Table**  
See Note 1

LOAD			INTERNAL BATTERY ONLY	NUMBER OF EXTERNAL BATTERY CABINETS					
				1	2	3	4	5	6
%	VA	W	Minutes						
25	500	450	23	85	159	228	300	364	423
50	1000	900	9	39	73	111	151	188	225
69	1380	1242	6	27	50	77	104	132	160
75	1500	1350	5.7	10	10	10	10	10	10
80	1600	1440	3.5	3.5	3.5	3.5	3.5	3.5	3.5
90	1800	1620	3.5	3.5	3.5	3.5	3.5	3.5	3.5
100	2000	1800	3.2	3.5	3.5	3.5	3.5	3.5	3.5

**Table 6-6 GXTRT-3000IRT2UXL Runtime Table**  
See Note 1

LOAD			INTERNAL BATTERY ONLY	NUMBER OF EXTERNAL BATTERY CABINETS					
				1	2	3	4	5	6
%	VA	W	Minutes						
25	750	675	26	95	168	242	312	380	443
50	1500	1350	11	42	78	115	155	195	234
69	2070	1863	6	28	52	79	107	136	165
75	2250	2025	5.8	10	10	10	10	10	10
80	2400	2160	3.5	3.5	3.5	3.5	3.5	3.5	3.5
90	2700	2430	3.5	3.5	3.5	3.5	3.5	3.5	3.5
100	3000	2700	3.3	3.5	3.5	3.5	3.5	3.5	3.5

**Note 1:** When the output load is >80% of full load, the discharge time limit is set to 3.5 min. When the output load is >70% and <80%, the discharge time limit is set to 10 min. When the output load is <70% load, there is no limit other than battery capacity.



# Appendix I: Technical Support

Our Technical Support staff is ready to assist you with any installation or operating issues you may encounter with your Liebert® product. Please call or e-mail us:

## **In Europe, Middle East, and Asia**

### **EMEA Multi-Language Technical support**

e: [eoc@vertiv.com](mailto:eoc@vertiv.com)  
p: Toll free 0080011554499  
p: Toll +39 02 98250222

## **In the United States**

### **Technical support**

e: [liebert.upstech@vertiv.com](mailto:liebert.upstech@vertiv.com)  
p: 1-800-222-5877 menu option 1

### **Monitoring support**

e: [liebert.monitoring@vertiv.com](mailto:liebert.monitoring@vertiv.com)  
p: 1-800-222-5877 menu option 2

### **Warranty support**

e: [microups.warranty@vertiv.com](mailto:microups.warranty@vertiv.com)  
p: 1-800-222-5877 menu option 3

