

# Performance Testing of Zinc-Bromine Flow Batteries for Remote Telecom Sites

David M. Rose, Summer R. Ferreira  
Sandia National Laboratories  
Albuquerque, NM (USA) 871285

## Abstract

Telecommunication (telecom) sites are often located far from the (AC) electric grid. The electric generators installed at these sites are often very lightly loaded, either because of low usage or high renewable generation. This can result in the generators operating inefficiently. Electrical energy storage, if implemented properly, has the potential to save fuel at sites like these. In principle, this is done by allowing the generator to run more efficiently at a high electrical load while charging energy storage with excess capacity, and remain idle while the energy storage discharges to support the load. This paper describes how the application of Zinc Bromine (Zn-Br) flow batteries could effectively support remote telecom applications through extrapolation of performance metrics from example system test data to remote telecom applications.

**Key words:** *telecommunication, energy storage, zinc bromine, batteries, hybrid energy systems.*

**Acknowledgments:** The author gratefully acknowledges the support of Dr. Imre Gyuk and the Department of Energy's Office of Electricity Delivery & Energy Reliability

Sandia National Laboratories is a multi-program laboratory managed and operated by Sandia Corporation, a wholly owned subsidiary of Lockheed Martin Corporation, for the U.S. Department of Energy's National Nuclear Security Administration under contract DE-AC04-94AL85000.

## Introduction

Building backup power systems, electric vehicles, and telecommunication facilities that use various battery technologies represent a range of standard electrical energy storage applications. Batteries allow such electrical systems to function for a period of time without connection to grid tied electricity. Recharge of batteries is easily achieved when an electric system is connected to the electric grid. At remote telecommunication (telecom) sites, a power line to the electric grid can prove to have prohibitive cost to build due to environmental, engineering, licensure, and/or maintenance considerations. Batteries offer advantages for remote locales; however, there are tradeoffs.

Consider the following scenarios. Case A: One telecom site has 5kW average electric load supported by an installed 20kW generator. In this scenario the generator is running inefficiently and is most likely wet stacking. Generators that are loaded below 30% of their rated power are considered wet stacked and do not cleanly burn the fuel they consume. The resulting grime buildup can result in increased maintenance costs and even premature failure. Now consider Case B: A 5kW cycling battery is added to the telecom site in Case A. As the battery charges, the electrical load on the generator is doubled to 10kW (50% rated power). Then, as the battery discharges, the electrical load on the generator drops to 0kW and the generator is allowed to shut down.

Case B is one example of how energy storage can be used to cause a generator to operate more efficiently and avoid wet stacking. However, to save fuel overall, simply cycling the battery isn't enough. The storage of electrical energy is never 100% efficient. To make the overall system consume less fuel the generator in Case B must have improved efficiency to overcome the energy storage losses.

The utilization of zinc-bromine (Zn-Br) flow batteries as energy storage support in a remote telecom application offers a unique set of advantages. Zn-Br chemistry lends itself to an energy dense design that has a wide range for operating in varied environmental conditions. This paper describes how use of Zn-Br flow batteries can support the unique requirements of telecom applications. This discussion includes an explanation of how and where a generic energy storage device can be used to create greater generator efficiency, brief introduction of Zn-Br flow batteries, testing data, and analysis that applies it to this application. It then proposes a telecom circuit that can utilize multiple Zn-Br batteries to greater effect.

### Efficiency Differential: Generator & Fuel Consumption Considerations

The fuel curve of a small generator (20-60kW) is a straight line with an idle (zero load) fuel consumption. (Fuel consumption data obtained from a publicly available Approximate Fuel Consumption Chart [3]). Figure 1 shows the fuel consumption of a 20kW generator. The fuel consumption of generators is listed at four points 25%, 50%, 75%, and 100% loading (shown in blue). A linear approximation of this can be drawn to allow calculations to be performed on the resulting function. When a generator is running with low electrical load, it has a low fuel efficiency (shown in green). As the load increases, the generator is able to burn the fuel more efficiently. This is the margin that energy storage can utilize to make the system run more efficiently.

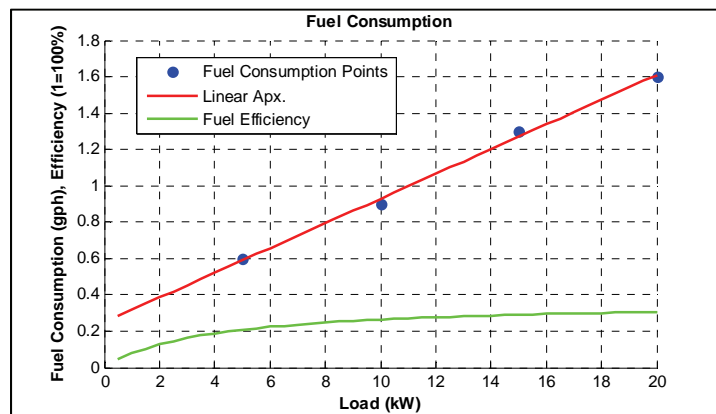

Figure 1 - Fuel Consumption Curve of a 20kW Generator [3]

To exploit this gap, energy storage must charge to push a generator up this curve and then discharge to allow it to shut down. Charging and discharging a battery in this way allows the generator to be operating more efficiently for some amount of time each day and off entirely for the remaining portion. The duty cycle of the generator is defined to be the average proportion of time that the generator is running. The duty cycle of the generator in Case A from the introduction would be 1 (meaning it is running 100% of the time). The duty cycle of the generator in Case B can be calculated using Equation 1.

$$\text{duty cycle} = \frac{1}{1 + \frac{\text{Efficiency} \times \text{Charge Rate}}{\text{Discharge Rate}}} \quad \text{Equation 1}$$

Where:

- Efficiency is the electrical energy efficiency of an energy storage device
- Charge Rate is the Maximum charge rate of the energy storage or the difference between generator rating and telecom load (whichever is less)
- Discharge Rate is the total DC telecom load.

In addition to the generator duty cycle, the battery's operating time must also be considered. Many battery chemistries have conditioning cycles that maintain design life but cause them to be unavailable for certain periods of time. The Conditioning Time (CT) is the proportion of time per cycle that the energy storage is unavailable for charge or discharge. Equations 2 and 3 shows the calculating of CT given a set duration of conditioning cycle.

$$T = \frac{\text{Energy}}{\text{Efficiency} \times \text{Charge Rate}} + \frac{\text{Energy}}{\text{Discharge Rate}} \quad \text{Equation 2}$$

$$CT = \frac{\text{DCC}}{T + \text{DCC}} \quad \text{Equation 3}$$

Where:

- CT is the Conditioning Time
- T is the period of the charge and discharge cycle without any conditioning cycle
- Duration of Conditioning Cycle (DCC) is the amount of time that a conditioning cycle takes
- Energy is the electrical energy capacity of the energy storage device

The duty cycle of the generator, the period, the duration of conditioning cycle, and the conditioning time of the battery are used to derive Fuel Savings (FS) in Equation 4

$$FS(gph) = F_1 - \left( F_2 \times \text{duty cycle} \times \frac{T}{T + \text{DCC}} + F_1 \times CT \right) \quad \text{Equation 4}$$

Where:

- $F_1$  is the fuel consumption rate of the generator only supporting the load,
- $F_2$  is the fuel consumption rate of the generator supporting the load and charging the battery.

Using Equation 4 the ideal fuel savings can be calculated for a general energy storage device given the following assumptions.

Ideal Model Assumptions and Limitations:

- The energy storage device is either charging or supporting the load at all times; this means that there is no time spent resting or undergoing conditioning cycles
- The telecom site has a 20kW generator and an energy storage device that can charge at a maximum rate of 20kW.
- The energy storage device is capable of supporting the full electrical load 1-20kW.
- The electrical load is constant
- AC loads are neglected in this calculation

Figure 2 shows a plot of the percentage fuel savings using this calculation over a range of energy storage efficiencies and telecom electrical load. In cases of low electrical load compared to generator size there is a significant gap to exploit for fuel savings. Additionally, the more efficient the energy storage device is, the better the fuel saving performance of the system. The gray plane shows the zero fuel savings decision boundary; below this line the implementation of energy storage will actually cause higher fuel usage.

Fuel Saving Conditions in Telecom Application (20kW Generator)

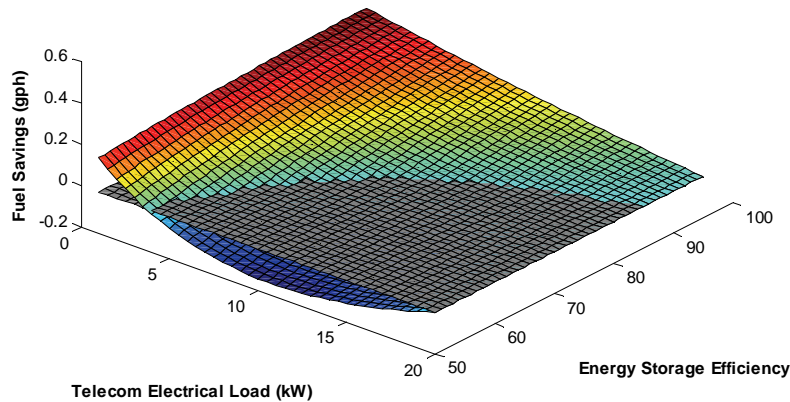

Figure 2 - Fuel Savings Decision Boundary

These are ideal calculations based on the above conditions. The next section shows how the characteristics of a specific Zn-Br flow battery can be used to refine this model.

### Zinc-Bromine Flow Batteries

Flow batteries have an electrolyte, containing chemical compounds that react to convert chemical energy to electricity (called electroactive species), which flows through an electrochemical cell. Flow batteries are characterized by tanks located external to the electrode. In redox-flow batteries, the battery capacity is determined only by the size of these external tanks. The charge and discharge occur as oxidation and reduction of the species in the electrolyte. One category of flow battery is the hybrid flow battery. A hybrid flow battery is defined by one or more electroactive species being deposited as a solid [4]. In the hybrid Zn-Br battery the capacity is determined both by electrolyte volume and electrode area on which the solid zinc is deposited. Therefore, the tank and battery stack must be sized together to dictate capacity.

The Zinc-Bromide Battery Module (ZBM), shown in Figure 3, is a flow battery developed by RedFlow Limited. Sandia National Laboratories was supplied with a System Development Kit (SDK) and an Residential Unit (which include ZBMs) for third-party testing. Table 1 shows the ZBM system ratings.

**Table 1 - ZBM Ratings**

Rating Name	Value
Discharge Power Rating	5 kW
Energy Rating	10 kWh
Max Charge Current	60 A (SDK) / 40A (Residential Unit) *
Max Charge Voltage	66 V
Max Charge Capacity	250 Ah
Ambient Temperature Range	0-45°C

\*The SDK has 3 cell stacks in parallel, the Residential Unit only has 2 which limits charge current



**Figure 3 - Redflow Zinc-Bromide Battery Module (ZBM) within a System Development Kit (left) and within a demonstration residential unit R510US (right)**

Zn-Br batteries such as this have several unique characteristics that set them apart from other chemistries.

- Zn-Br is fully discharged during storage and shipment and hence has zero DC voltage on its terminals on commissioning.
- Other battery chemistries can be discharged to zero volts however doing so can be inefficient and degrade life, as is the case with lead-acid or become more volatile, as is the case with Lithium-Ion.
- Charging it puts voltage on the DC bus, which it will hold until discharged again.
- Just as lead-acid batteries need to be fully charged on a regular basis to maintain life, Zn-Br batteries must be fully discharged every few days to maintain life.
- The need to condition by fully discharging is to mitigate zinc dendrites that can puncture the separator when allowed to grow.
- After between 1 and 4 cycles, at the end of a full discharge, the system must undergo a strip cycle (a process of shorting the battery terminals across a low impedance shunt, while the electrolyte pumps are running, that removes excess zinc from the battery stack). A strip cycle can take between 0.5-2 hours; however, other factors such as temperature and use history can affect this, therefore the manufacture guidelines must be consulted to determine an adequate strip cycle.

The system ratings in Table 1 and the characteristics of the strip cycle yield precise numbers for the Charge Rate, Discharge Rate, Energy, and Duration of Conditioning Cycle in the Fuel Savings calculation in Equation 3. To determine the operational efficiency the following section will discuss the results of third party testing at Sandia.

## SDK Testing

The SDK DC system has circuitry to charge from a DC power supply and discharge to a load. The following tests were performed to determine a range of energy efficiencies under which the system operates. The rate sensitivity test shows how cycle efficiency changes depending on charge and discharge rates. The temperature sensitivity test shows how the cycle efficiency changes depending on ambient temperature.

### Rate Sensitivity Test

The ZBM was charged to 240Ah (near full charge) at three different rates (15A, 30A, and 60A) and was discharged at three different rates (15A, 30A, and 60A) to collect data for the following efficiency values. 240Ah is shown which is where the system operates at somewhat higher efficiency than at higher charge capacity. Table 3 shows the efficiency map for the ZBM. The highlighted cells are the energy efficiency at the maximum charge rate. Equation 1 shows that a high charge rate will result in a lower duty cycle for the generator. Hence this is the zone of operation that will yield the highest fuel savings.

**Table 2 - Rate Sensitivity Test Results (240 Ah). [1]**

Energy Efficiency	Charge at 15 A	Charge at 30 A	Charge at 60 A
<b>Discharge at 15 A</b>	71.3 %	73.1 %	71.4 %
<b>Discharge at 30 A</b>	73.2 %	76.0 %	74.5 %
<b>Discharge at 60 A</b>	71.6 %	74.8 %	73.7 %

### Temperature Sensitivity Test

In each cycle the system was charged at 30A to 240Ah and then discharged at 30A until empty. In hotter conditions the system has a higher self-discharge rate and lower energy efficiency. While self-discharge rate is less important for continuous cycling applications if a device was installed at a telecom site to offset peak load or shift solar generation it would have higher importance. This range of operation would be needed for many telecom sites in hot or cold climates.

**Table 3 - Temperature Test Results**

Energy Efficiency	10° C	25° C	40° C
No Float	75.1 %	75.9 %	70.2 %
5 hour float at full charge	69.9%	68.1%	59.9%
10 hour float at full charge	64.6%	61.8%	46.8%

Self-Discharge	10° C	25° C	40° C
Ah per Hour	-2.5	-3.5	-5.8
% of Capacity per Hour	1.0 %	1.4 %	2.3 %

Note that these numbers are for active float where the electrolyte is being circulated continuously, if the pumps were stopped it would decrease the self-discharge but the pumps would need to be started again resulting in a lag time before it can supply power.

In the next section these efficiency values are studied with the fuel savings model to give a sense for how variation in operation can affect the achieved fuel savings.

## Residential Unit Testing

This is a grid connected system with an integrated ZBM. The installed ZBM has two cell stacks in parallel while the ZBM in the SDK has three. This results in a lower maximum charge current of 40A and a slightly higher internal resistance. A series of AC tests were performed which involved significant cycling. These included varied charge and discharge rates, capacities, and active float times. During AC testing, DC measurements were taken and recorded. A summary of the testing is shown in Table 4.

**Table 4- Residential Unit Testing Overview**

Approximate Duration	10 Months
Temperature Range	25 °C (-5, +15)
Total DC Charge Energy	1277 kWh
Total DC Discharge Energy	997 kWh
Approximate Total Cycle Count	100 cycles

During testing input parameters were varied such that different AC properties could be tested. Over the testing period high energy cycles (cycles where the system was charged higher than 200Ah) were collected and arranged against the approximate total cycle count (energy on discharge divided by 10kWh capacity rating). From there, the cycles were down selected to remove any with float times over an hour. Figure 4 shows these data along with a regression line that approximates the efficiency fade over approximately 75 cycles of time and use. After this time a series of control system tests were performed on the AC inverter/charger. This involved significant energy throughput (250 kWh or so) but did not involve calibration cycles, this makes it unfeasible to compare performance degradation after this point.

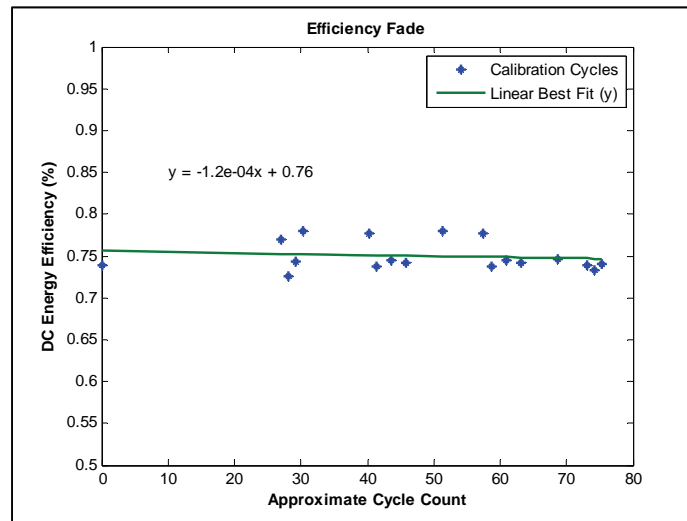

**Figure 4 - Life-Cycle Testing of Residential Unit**

Note: The system has not been cycled to failure and so the linear best fit should not be relied on for end of life determination.

By the linear approximation the system started with 75.6% energy efficiency which fell to 74.7% at the end of the test period. This degradation is not significant to the accuracy of the measurement. No conclusions about cycle life can be made other than this system showed no signs of degradation or failure after 75 cycles. The mean DC efficiency over this period was 75% with a standard deviation of 1.8%.

A long life is important in a telecom fuel savings application because it is the direct measure of how often the system will need to be replaced. Total fuel savings over the life of a system is often what will determine if a project is financially viable or not.

### Zinc-Bromide Batteries in a Telecom Application

Equations 1 - 4 can be reapplied with a narrowed range of values.

For this design of Zn-Br flow battery:

- Efficiency = 73.2% max, 72.4% for cold conditions, and 67.5% for hot conditions.
- Charge Rate = 3.6kW (60A at 60VDC for the SDK design)
- Discharge Rate = Electrical Load (max 5kW)
- Duration of Conditioning Cycle = 0.5 to 2 hours
- Energy = 10kWh

Figure 5 shows the results of this sensitivity study. Subplots (a) and (b) show the percent fuel savings for durations of strip cycle of 1.0 and 2.0 hours respectively. Displayed on both subplots are four lines: the zero fuel savings decision boundary and the fuel savings at 25, 10, and 40°C ambient. The ambient temperature both high and low has a small negative effect on fuel savings.

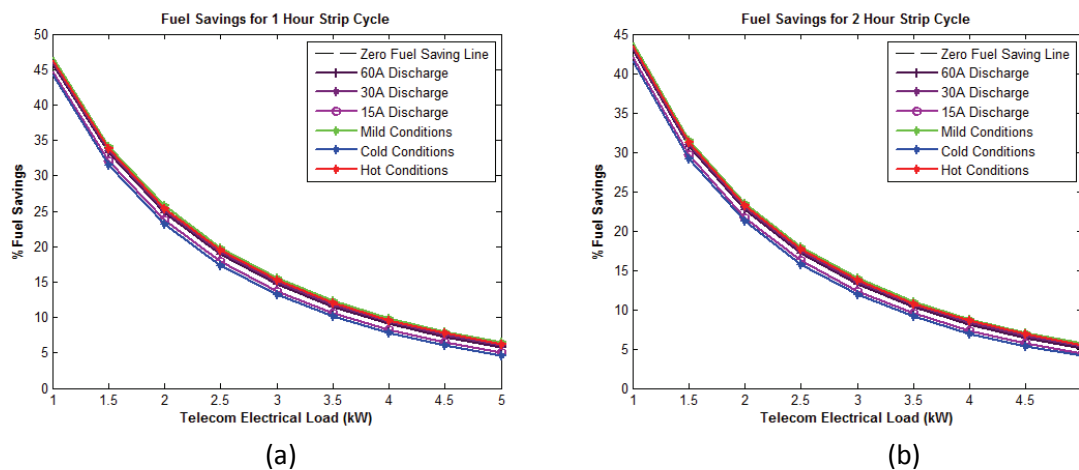

**Figure 5 - Percent Fuel Savings per Load, Temperature, and Strip Cycle Duration**

The next section will discuss how a combination of two or more of the systems may make up for drawbacks and emphasize advantages of the technology.



## Proposed Zinc-Bromide Telecom Circuit

This paper has shown that high efficiency, long life, and short strip cycles under a range of environmental conditions are what mathematically lead to higher fuel savings. This section discusses a potential telecom circuit that maximizes these properties in a Zn-Br system. Figure 6 shows the proposed telecom circuit. In this circuit the batteries are charged together and discharged individually (one-at-a-time). Staggered operation reduces the energy throughput of each battery effectively prolonging the cycle life of the installation.

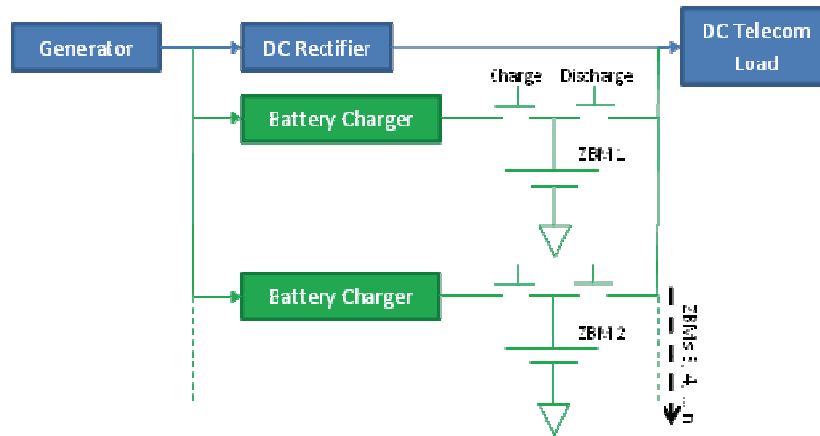

Figure 6 - Proposed Zinc-Bromide Telecom Circuit

With two or more systems, each performing a strip cycle every two or more full energy cycles, the downtime from the strip cycle can be effectively eliminated. To explore how this is done, consider the example of a telecom site with two ZBMs each performing strip cycles every other full discharge. The system would cycle as illustrated in the flowchart in Figure 7.

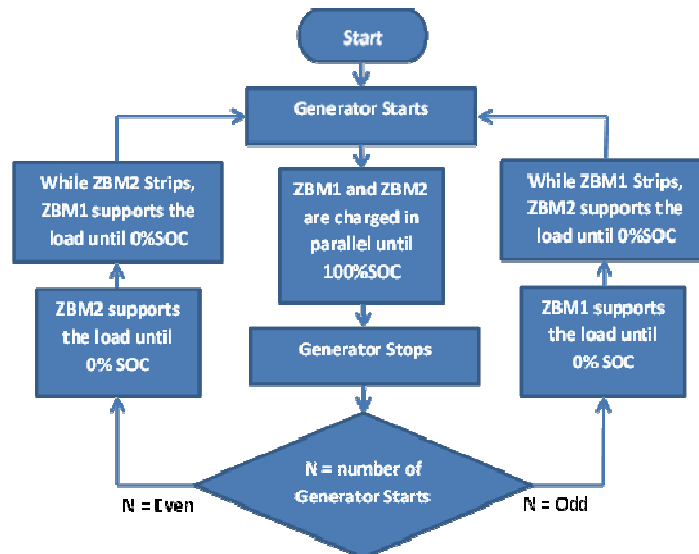

Figure 7 - Telecom Circuit Flow Chart

This algorithm allows the installed ZBM's to alternate which one supports the load first and performs a strip cycle and which one supports the load second and does not perform a strip cycle, effectively eliminating the downtime. One drawback of this circuit is that it requires the ZBM's not currently in use to float until used which leads to reduced energy efficiency. Accounting for this, Figure 8 shows the fuel saving performance of the proposed circuit with two installed Zn-Br batteries. The black line shows the baseline performance of one ZBM. The blue, green, and red lines show the proposed circuit's performance in cold, mild, and hot conditions respectively. The break in these lines at 5kW is because of the 5kW rating of the ZBM. Above this electric load both ZBM's must operate to support the load and hence a nominal 1 hour strip cycle is reintroduced. Notice that under hot conditions, and load close to 10kW, the fuel savings actually dips below zero. This means that under these specific conditions the energy storage could actually cause the system to consume more fuel.

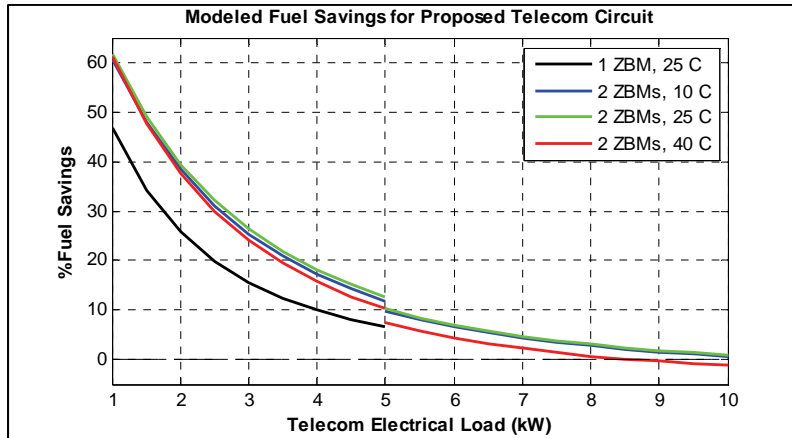

Figure 8 - Performance Improvements from Proposed Zinc-Bromide Circuit

Note that this could be done with other chemistries such as lead-acid but as this configuration maximizes the time the system spends 0% SOC it is uniquely applicable to normally energy empty chemistry such as Zn-Br.

## Summary

This paper has shown that there can be significant margin for fuel savings at remote telecom sites operating under specific conditions. Where there is low electrical load and large installed generation there is the potential for energy storage to save fuel over a range of energy storage efficiencies. Zinc-bromide flow batteries are one such technology that can be implemented to exploit this margin. Testing results of a specific design provided unique characteristics that were used to refine the general fuel savings model to apply directly to the technology. Additionally, testing results demonstrated the cycling ability of the device and showed limited cycle life data. The resulting calculations from the refined models showed where applications of the ZBM design would likely save fuel and where it would likely use more fuel. A circuit was then proposed to use multiple systems in parallel to maximize the benefits and minimize the drawbacks of the technology. Future work will include further testing of cycle parameter sensitivities, real site validation, and studies of multi-generator microgrids.

## References

- [1] Rose, D. M., Ferreira, S. R., "Initial Test Results from the RedFlow 5 kW, 10 kWh Zinc-Bromide Module, Phase 1" *Sandia National Laboratories Report 2012-1352, February 2012*
- [2] Vigerstol, O., "Testing nickel cadmium batteries for remote telecom power applications," *Telecommunications Energy Conference, 1998. INTELEC. Twentieth International* , vol., no., pp.642-648, 1998
- [3] Diesel Service & Supply Inc. (2013, February 10<sup>th</sup>). "Approximate Fuel Consumption Chart" Web, Available [http://www.dieselserviceandsupply.com/temp/Fuel\\_Consumption\\_Chart.pdf](http://www.dieselserviceandsupply.com/temp/Fuel_Consumption_Chart.pdf)
- [4] A.Z. Weber, M.M. Mench, J.P. Meyers, P.N. Ross, J.T. Gostick and Q. Liu, Redox Flow Batteries: A Review, *Journal of Applied Electrochemistry* 41, 1137-1164 (2011)