

# BDS–256XL Combined Reading Battery Diagnostic System Installation Instructions



Vertiv Corporation

1050 Dearborn Drive

Columbus, OH 43085

Tel: (954) 377-7101

[www.vertivco.com](http://www.vertivco.com)

590-2098-501A/SL-29413/4200-066 R6

# BDS–256XL Combined Reading Battery Diagnostic System Installation Instructions



Vertiv Corporation

1050 Dearborn Drive

Columbus, OH 43085

Tel: (954) 377-7101

[www.vertivco.com](http://www.vertivco.com)

590-2098-501A/SL-29413/4200-066 R6

The information contained in this document is subject to change without notice and may not be suitable for all applications. While every precaution has been taken to ensure the accuracy and completeness of this document, Vertiv assumes no responsibility and disclaims all liability for damages resulting from use of this information or for any errors or omissions. Refer to other local practices or building codes as applicable for the correct methods, tools, and materials to be used in performing procedures not specifically described in this document.

The products covered by this instruction manual are manufactured and/or sold by Vertiv. This document is the property of Vertiv and contains confidential and proprietary information owned by Vertiv. Any copying, use or disclosure of it without the written permission of Vertiv is strictly prohibited.

### Notice to Users

Vertiv Corporation reserves the right to make changes to this document without notice to any user or reseller of this product. Vertiv Corporation also reserves the right to substitute or terminate distribution of this document, with no obligation to notify any person or party of such substitutions or terminations.



#### EUROPEAN UNION CUSTOMER NOTICE: Disposal of Old Appliances\*

This product uses components that are dangerous for the environment, such as electronic cards and other electronic components. Any component that is removed must be taken to specialized collection and disposal centers. If this unit must be dismantled, this must be done by a specialized center for collection and disposal of electric and electronics appliances or other dangerous substances. This product has been supplied from an environmentally aware manufacturer that complies with the Waste Electrical and Electronic Equipment (WEEE) Directive 2002/96/EC. The "crossed-out wheelee bin" symbol to the left is placed on this product to encourage you to recycle wherever possible.

Please be environmentally responsible and recycle this product through your recycling facility at its end of life. Do not dispose of this product as unsorted municipal waste. Follow local municipal waste ordinances for proper disposal provisions to reduce the environmental impact of waste electrical and electronic equipment (WEEE) Directive 2012/19/EU.

For information regarding the scrapping of this equipment, go to [www.eu.emersonnetworkpower.com](http://www.eu.emersonnetworkpower.com) ("Products" or "Contact us" sections) or call Emerson's worldwide technical support at: **00 80011554499 (Toll free number)** or **+39 0298250222 (Toll number based in Italy)**

*\*This notice only applies to 50Hz units placed on the European Union market.*



# Table of Contents

<b>1</b>	<b>LEGAL INFORMATION</b>	<b>1</b>
1.1	FCC DECLARATION OF CONFORMITY	1
1.2	REGULATORY INFORMATION	1
1.2.1	Type Of Service	1
1.2.2	Telephone Company Procedures	1
1.3	SERVICE	1
<b>2</b>	<b>SAFETY INFORMATION</b>	<b>2</b>
2.1	General	2
2.2	Before Applying Power	2
2.3	Ground the Equipment/Chassis	3
2.4	Fuses	3
2.5	Do Not Remove Equipment Cover	3
2.6	Do Not Operate Damaged Equipment	4
2.7	Do Not Service or Adjust Alone	4
2.8	Do Not Substitute Parts or Modify Equipment	4
2.9	Ensure Rack/Chassis/Shelving/Mounting Stability	4
2.10	Radiated Immunity	4
2.11	Insulation Rating for Wires	4
2.12	Ventilation	5
2.13	Drawings	5
2.14	Warning	5
2.15	Caution	5
2.16	Note:	5
2.17	Safety Symbols	6
<b>3</b>	<b>EMERGENCY SHUTDOWN SWITCH/ DISCONNECT DEVICE</b>	<b>6</b>
3.1	BDS Disconnect Device	6
3.2	Uninterruptible Power Supply UPS	6
<b>4</b>	<b>PREVENTIVE MAINTENANCE</b>	<b>7</b>
4.1	Visual Inspection	7
4.2	Cleaning System Components	7
4.3	Fans and Vents	7
4.4	Sense Leads (When Applicable)	7
4.5	Internal Components	7
4.6	Shipping, Storage, Normal Use Protection	8
<b>5</b>	<b>PRODUCT OVERVIEW THE BDS–256XL SYSTEM</b>	<b>8</b>
5.1	Measurement Capabilities	8

5.2	<i>Features</i> .....	8
5.2.1	Standard.....	8
5.2.2	Optional .....	9
5.2.3	Alarm Features.....	9
5.3	<i>Model Number</i> .....	9
5.3.1	CM–XL8 Controller Module Model Number Description .....	9
5.3.2	DCM–XL48 Data Collection Module Model Number Description .....	10
5.3.3	RTM–XLR Resistance Test Module Model Number Description .....	10
5.4	<i>Materials</i> .....	11
5.4.1	Standard.....	11
5.4.2	Optional .....	19
5.5	<i>Required Tools</i> .....	22
5.6	<i>Building Management System Integration</i> .....	25
5.7	<i>Panel Controls And Indicators</i> .....	25
5.7.1	CM–XL8.....	26
5.7.2	DCM–XL48 .....	30
5.7.3	RTM–XLR.....	31
5.8	<i>Specifications</i> .....	32
5.8.1	BDS–256XL System Specifications .....	32
5.8.2	Cabinet Specifications.....	35
5.8.3	CM–XL8 Controller Specifications.....	36
5.8.4	DCM–XL48 Specifications .....	38
5.8.5	RTM–XLR Resistance Test Module Specifications .....	39
<b>6</b>	<b>BEFORE SYSTEM INSTALLATION</b> .....	<b>41</b>
6.1	<i>Required Drawings</i> .....	41
6.2	<i>System Configuration</i> .....	41
6.3	<i>Location Consideration</i> .....	43
6.3.1	Power.....	43
6.3.2	Physical Mounting .....	44
6.3.3	Check Service Access .....	44
6.3.4	Maximum Wire And Cable Lengths .....	44
6.3.5	Fiber Optic Cable And DCM Communication Information .....	44
6.3.6	Conduit .....	46
6.3.7	Panduit.....	46
<b>7</b>	<b>BEGIN SYSTEM INSTALLATION</b> .....	<b>46</b>
7.1	<i>Identify &amp; Verify Cells, Markings, Load Steps, Configuration, etc.</i> .....	46
7.2	<i>Fit Tab Washers</i> .....	47
7.3	<i>Voltage Sense Lead Connection Preparation</i> .....	48
7.4	<i>Step By Step Instructions</i> .....	50
7.5	<i>Sense Lead Harness Routing from DCMs to the Battery</i> .....	56
7.6	<i>Cell Voltage Sense Lead Connections</i> .....	56
7.7	<i>Intertier Connections</i> .....	56

7.8 Internal Resistance Test Current Cable Connections ..... 57

7.9 Overall Voltage Sense Leads..... 57

7.10 Resistance Test Module Control Cable Connections..... 57

7.11 Discharge Current Sensor (Optional)..... 57

7.12 Temperature Sensor (Optional)..... 57

7.13 Float Current Sensor (Optional)..... 58

7.14 Conduit ..... 63

7.15 System with No Local Computer..... 63

7.16 System with Local Computer ..... 64

7.17 Alarm Contacts and Remote Alarm Reset ..... 65

**8 FINAL STEPS CONNECTING TO BATTERY TERMINALS ..... 65**

**9 FINAL STEPS COMMUNICATION CONNECTIONS ..... 66**

9.1 Communication Connections..... 66

9.2 Modem ..... 66

9.3 USB ..... 67

9.4 RS-232..... 68

9.5 RJ-45 ..... 68

**10 DRAWINGS..... 68**

## Table of Figures

Figure 1. CM-XL8 Controller Module Model Numbers ..... 10

Figure 2. DCM-XL48 Data Collection Module Model Numbers ..... 10

Figure 3. RTM-XLR Resistance Test Module Model Numbers..... 11

Figure 4. Sense Lead Harness..... 11

Figure 5. DCM Overall Volts Cable ..... 12

Figure 6. DCM Temperature Connection Sense Lead Harness pn 1101-1183-xx..... 12

Figure 7. 2 Cond 16 GA Black Zip Cord..... 13

Figure 8. Fiber Optic Polishing Kit ..... 13

Figure 9. Fiber Optic Cable..... 13

Figure 10. CM, DCM, RTM = BDS-256XL System ..... 14

Figure 11. DCM Control..... 14

Figure 12. 4 POS – 8 POS Pluggable Terminals ..... 14

Figure 13. 7' Telephone Cable-UL ..... 15

Figure 14. 10 Gauge-<sup>5</sup>/<sub>16</sub>" Insulated Ring Term UL..... 15

Figure 15. BDS Flex Resist w/Butt Splice..... 15

Figure 16. Exterior USB Cable ..... 16

Figure 17. 30 Amp Connector Block-UL ..... 16

Figure 18. 30 Amp Contact ..... 16

Figure 19. ¼" Tab Washer ..... 17

Figure 20. 30 Amp Slo–Blo Ceramic Fuse.....	17
Figure 21. 12 Gauge UL1015 Red.....	17
Figure 22. ¼” Heat Shrink Tubing.....	17
Figure 23. Controller Power Cord(s) .....	18
Figure 24. Inline Fuseholder Assembly .....	18
Figure 25. RS–232 Cable.....	18
Figure 26. Multitel Float Charging Current Probe.....	19
Figure 27. Power Source For FCCP pn 4000–026.....	19
Figure 28. Ambient Temperature Probe 2900–029.....	20
Figure 29. Electrolyte Temperature Probe 2900–010 .....	20
Figure 30. 2000 Amp Current Transducer CT.....	20
Figure 31. Float/CT Cable.....	21
Figure 32. CT Cable.....	21
Figure 33. Female Disconnect Adapter .....	21
Figure 34. Anderson Crimping Tool 1309G2.....	22
Figure 35. Panduit CT–260 Crimper .....	22
Figure 36. Panduit CT–1525 Crimper .....	22
Figure 37. Panduit CT–1550 Crimper .....	22
Figure 38. Thomas & Betts WT–111–M For Crimper.....	22
Figure 39. #2 Phillips–Head Screwdriver With Insulated Handle .....	23
Figure 40. Digital Voltmeter.....	23
Figure 41. Molex Crimp Tool.....	23
Figure 42. Flat–Head Stubby Screwdriver.....	23
Figure 43. Computer/PC .....	24
Figure 44. BMDM Software Icon.....	24
Figure 45. Inkjet Printer .....	24
Figure 46. Website .....	25
Figure 47. Controller Front Panel With USB CM–XL8 .....	26
Figure 48. CM–XL8 Front Panel Indicators LEDs Explained.....	26
Figure 49. User Replaceable Fuses 1 And 2 CM–XL8 Rear Panel.....	27
Figure 50. F1 And F2 Fuse Ratings Table* .....	27
Figure 51. CM–XL8 Input/AC Power Block.....	28
Figure 52. CM–XL8 Output/Load Control/Control Outputs/Digital Inputs.....	28
Figure 53. CM–XL8 TELCO, Alarms, Reset, Fiber Optic, LAN, RS232.....	29
Figure 54. DCM–XL48 Front Panel .....	30
Figure 55. DCM–XL48 Front Panel Indicators Explained.....	30
Figure 56. DCM–XL48 Rear Panel Connectors Explained.....	30
Figure 57. DCM–XL48 Rear Panel Controls .....	31
Figure 58. RTM–XLR .....	31
Figure 59. RTM–XLR LEDs.....	31
Figure 60. RTM–XLR Rear Panel Connectors.....	32
Figure 61. Required Drawings.....	41
Figure 62. BDS–256XL Configuration Options.....	43
Figure 63. DCM Fiber Optic Connections.....	45



Figure 64. Minimum Bend Radius Of Fiber Optic Cable ..... 46

Figure 65. BDS Flex Resist W/Butt Splice–10KΩ Flameproof ..... 48

Figure 66. Strip Sense Lead Wire ..... 48

Figure 67. Insert Sense Lead Wire Into 10K Resistor Assembly ..... 49

Figure 68. Crimping With Panduit Crimper ..... 49

Figure 69. Crimping 10k Resistor Assembly To Sense Lead ..... 49

Figure 70. Checking 10K Resistor And Sense Lead Connection ..... 50

Figure 71. BDS–193–A453 Fuse Protected Load Lead (snapshot) ..... 50

Figure 72. Strip 12 AWG Load Lead Wire ..... 51

Figure 73. #30 Die With Andersen Contact/Pin ..... 51

Figure 74. Inserting Load Lead Wire Into Pin To Crimp ..... 51

Figure 75. Crimping Load Lead Wire To Pin ..... 52

Figure 76. Good Crimp ..... 52

Figure 77. Andersen Connectors Together ..... 52

Figure 78. Insert Andersen Contact Into Andersen Connector ..... 53

Figure 79. Tug On Assembled Connector ..... 53

Figure 80. Strip 12 AWG Load Lead Wire ..... 53

Figure 81. Thomas And Betts Crimper ..... 54

Figure 82. Crimp Fuseholder Onto Inline Fuseholder Assembly ..... 54

Figure 83. Checking Fuseholder/Load Lead Wire Connection ..... 54

Figure 84. Securing Fuseholder Load Lead Wire Connection With Heat Shrink ..... 55

Figure 85. DCM–XL48 Rear Panel Photo From Drawing BDS–1279–B1204 ..... 58

Figure 86. Multitel FCCP pn 5610–051 ..... 58

Figure 87. Float Cable ..... 59

Figure 88. Multitel FCCP Rear Panel ..... 59

Figure 89. FCCP Connections FCCP ..... 59

Figure 90. Multitel's FCCP–Routing The Cable ..... 60

Figure 91. Multitel's FCCP with Power Source And Inline Fuseholder ..... 60

Figure 92. Float Current Sensor ..... 60

Figure 93. Section 6.3 Of Multitel's FCCP Installation Manual Pg. 38 ..... 61

Figure 94. Section 6.3 Of Multitel's FCCP Installation Manual Pg. 39 ..... 62

Figure 95. BDS–123–A380 ID Full Washer Quick Connect Sense/Load Leads (snapshot) ..... 65

Figure 96. Modem Connection On The Rear Of CM–XL8 ..... 66

Figure 97. TELCO RJ–11 Modem Connection ..... 66

Figure 98. USB Cable ..... 67

Figure 99. Laptop ..... 67

Figure 100. USB Connection CM–XL8 Front Panel ..... 67

Figure 101. RS–232 Local Port Rear Panel CM–XL8 ..... 68

Figure 102. RS–232 9 Pin Female to Female Cable ..... 68

Figure 103. RJ–45 Connection Rear Panel CM–XL8 ..... 68

Figure 104. RJ–45 ..... 68



## **1 LEGAL INFORMATION**

### **1.1 FCC DECLARATION OF CONFORMITY**

This notice is applicable to Product/System/Hardware/Equipments with the Radio Frequency RF headset communication option installed for Bluetooth®-based communication.

This device complies with Part 15 of the FCC rules. Operation is subject to the following two conditions:

- (i) This device may not cause harmful interference, and
- (ii) This device must accept any interference received, including interference that may cause undesired operations.

### **1.2 REGULATORY INFORMATION**

#### **1.2.1 Type of Service**

The MPM Series and the BDS Series Vertiv Corporation. Product/System/Hardware/Equipment is designed to be used on standard device telephone lines. It connects to the telephone line by means of a standard jack called the USOC RJ11C or USOC FJ45S. Connection to telephone company provided coin service (central office implemented systems) is prohibited. Connection to party line service is subject to state tariffs.

#### **1.2.2 Telephone Company Procedures**

The goal of the telephone company is to provide the user with the best service it can. To do this, it may occasionally be necessary for the company to make changes in its equipment, operations, or procedures. If these changes might affect the Original Purchasing End User's service or the operation of the Original Purchasing End User's equipment, the telephone company will give the Original Purchasing End User notice, in writing, to allow the Original Purchasing End User to make any changes necessary to maintain uninterrupted service.

In certain circumstances, it may be necessary for the telephone company to request information from the Original Purchasing End User concerning the equipment that the Original Purchasing End User has connected to the telephone line(s). Upon request of the telephone company, provide the FCC registration number and the Ringer Equivalence Number REN; both of these items are listed on the equipment label. The sum of all the RENs on the telephone line must be less than five in order to assure proper service from the telephone company. In some cases, a sum of five may not be useable on a given line.

### **1.3 SERVICE**

Proper installation and testing are essential to the correct functioning of the system. If the user have questions, contact Vertiv Corporation. Request monitor assistance. Except as explained in this manual, do not attempt to service Vertiv equipment.

**WARNING:**

**Opening the equipment may expose personnel to dangerous voltages.**

Any adjustment, maintenance, or repair of this product must be performed by qualified personnel or contact a customer engineer through Vertiv Corporation. Never allow unauthorized personnel to operate the equipment. Only qualified and trained personnel are to perform the operations described in this manual. Calibration must be performed by technically qualified trained personnel.

## **2 SAFETY INFORMATION**

All safety information within must be read, understood and strictly adhered to before installing, powering up or using the equipment/software; i.e. the system.

The following general safety precautions must be observed during all phases of operation, service, and repair of this product. Failure to comply with these precautions or with specific WARNINGS elsewhere in this manual violates safety standards of design, manufacture, and intended use of the product. Vertiv Corporation, assumes no liability for the customer's failure to comply with these requirements.

**WARNING:**

**Use of this system in a manner not specified could compromise the designed-in safety.**

### **2.1 General**

For Safety Class 1 equipment, e.g. equipment provided with a protective earth terminal, an uninterruptible safety earth ground must be provided from the main power source to the product input wiring terminal or supplied power cable. The protective features of this product may be impaired if it is used in a manner not specified in the operation/installation instructions. This manual describes the general installation and use of the system. If the system has features or accessories not described in this manual, contact Vertiv Corporation.

### **2.2 Before Applying Power**

Check configuration and drawings. Double-check all connections. Verify that the system is set to match available voltage, the correct fuses are installed, and all safety precautions are taken.

**NOTE:**

*Notice the system's external markings described under Safety Symbols.*

**WARNING**

**High voltage or current may be present inside the equipment and on the equipment terminals.**

**Observe system's external markings and all electrical safety precautions when removing and installing equipment covers, when connecting leads, and when making adjustments.**

**Never energize the cabinet or any component with 115VAC (or 230VAC if applicable) or battery voltage until after the installation is complete.**

**Never exceed equipment voltage, power ratings, or capabilities.**

### 2.3 Ground the Equipment/Chassis

Make sure the equipment chassis and/or other system components are properly grounded when required.

To minimize shock hazard, the system chassis and/or cover must be connected to an electrical protective earth ground. The system must be connected to the AC power mains through a grounded power cable, with the ground wire firmly connected to an electrical/safety ground at the power outlet.

**WARNING**

**Any interruption of the protective (grounding) conductor or disconnection of the protective earth terminal will cause a potential shock hazard that could result in personal injury.**

### 2.4 Fuses

For continued protection against fire, only the fuses with the required rated current, voltage, and specified type, i.e. normal slo-blo, fast blow, time delay, etc. must be used.

**WARNING**

**Do not use repaired fuses or short-circuited fuse holders. To do so could cause a shock or fire hazard.**

**Some fuses may not be easily removed, contact Vertiv. Request monitor assistance.**

### 2.5 Do Not Remove Equipment Cover

Operating personnel must not remove equipment covers, shields, and or panels. Component repair and/or replacement and internal adjustments must be made only by qualified service personnel.

**WARNING**

**Under certain conditions, dangerous voltages may exist even with the equipment switched off.**

**To avoid dangerous electrical shock, DO NOT perform procedures involving cover, shield and/or panel removal.**

## 2.6 Do Not Operate Damaged Equipment



Equipment that appears damaged or defective must be made inoperative and secured against unintended operation until it can be repaired by qualified service personnel.

Whenever it is possible that the safety protection features built into this product have been impaired, either through physical damage, excessive moisture, or any other reason, **REMOVE POWER** and do not use the product until safe operation can be verified by qualified service personnel. If necessary, request service and repair from Vertiv Corporation. Sales and Service Office to ensure that safety features are maintained.

## 2.7 Do Not Service or Adjust Alone



While in the battery circuit, do not attempt internal service or adjustment of this equipment unless another person, capable of calling for or rendering first aid and resuscitation, is present.

## 2.8 Do Not Substitute Parts or Modify Equipment

Due to the possible danger of introducing additional hazards, do not install substitute parts or perform any unauthorized modification to the product. If necessary, request service and repair from Vertiv Corporation to ensure that safety features are maintained.

## 2.9 Ensure Rack/Chassis/Shelving/Mounting Stability

To ensure stability of the test bay, place heavier instruments near the bottom of the rack. Check the location of all equipment (including PCs) for stability. Make sure cabinets are well mounted.

## 2.10 Radiated Immunity

If and when subjected to abnormally high RFI fields they may affect the operation of the equipment.

## 2.11 Insulation Rating for Wires

Use only when supplied with the installation kit.

## 2.12 Ventilation

Never block equipment ventilation openings. The equipment must have adequate ventilation to prevent equipment overheating. If using a cabinet, allow at least 8" clearance on all sides of the cabinet for ventilation. Never block ventilation ports, and ensure the equipment is operated within the temperature and humidity ranges found in the Ventilation Guide Table and within the specifications:

Temperature range:	5° C to 40°C	41°F to 104°F
Humidity range:	0% to 80% RH (non condensing) at 5° C to 31° C	0% to 50% RH (non condensing) at 32°F to 40°C

## 2.13 Drawings

Drawings and Figures in this manual may be for reference only or may be superseded by later drawings. For the latest information and revision, refer to the drawings supplied with the system. Reference drawings are located in the rear of the manual.

## 2.14 Warning



### WARNING

Denotes a hazard. It calls attention to a procedure, practice, or condition, which, if not correctly performed or adhered to, could result in personal injury or death. Do not proceed beyond a WARNING symbol until the indicated conditions are fully understood and met. Refer to enclosed documents as well as OEM documentation.

## 2.15 Caution



### CAUTION

*This symbol/box denotes a hazard. It calls attention to an operating procedure, or condition, which, if not correctly performed or adhered to, could result in damage to or destruction of part or all of the product or permanent loss of data. Do not proceed beyond a CAUTION symbol until the indicated conditions are fully understood and met. Refer to enclosed documents.*







## 2.16 Note:



### NOTE:

*This symbol/box contains important information.*

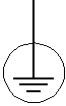
## 2.17 Safety Symbols

 conforms with European standards	 warning
 approved by Underwriters Laboratories	 caution
 protective earth (ground) terminal	 notice
 frame or chassis terminal	

## 3 EMERGENCY SHUTDOWN SWITCH/ DISCONNECT DEVICE

In most cases, the three prong AC cord from the cabinet, which connects to the 115VAC or 230VAC receptacle, is considered the primary disconnect device.

### 3.1 BDS Disconnect Device

The power switch on the rear of the BDS controller unit is considered the primary disconnect device.



*Different systems may have different disconnect procedures, please refer to the installation instructions or contact Vertiv.*

### 3.2 Uninterruptible Power Supply UPS



**The BDS system is designed to connect to UPS systems that are 600VDC or less and a maximum of 300V with respect to earth ground. The user must verify the voltage with respect to earth ground before connecting the system. Do this by measuring the voltage from each battery post referenced to earth ground. The voltage cannot exceed 300V.**

If the user is using an optional UPS with the system, be certain the UPS internal battery is functional. Follow instructions in the UPS manufacturer's manual.



## 4 Preventive Maintenance

### 4.1 Visual Inspection

Visually inspect all monitor system components for damaged or frayed power cords and cables, and damaged component panels, controls, and connectors. When damage is detected, remove the equipment from service until the damage is repaired.

### 4.2 Cleaning System Components

Clean system components using a soft cloth, slightly moistened with water. Do not use commercial or industrial cleaners that may attack the computer display and housing. Never expose the computer or system components to water, high humidity, or dampness.

**WARNING:**

**Before cleaning equipment, ensure the system is disconnected and power to the units has been shut off. The user must disconnect system components and the monitor system cabinet, if a cabinet is being used, from AC and/or DC power sources.**

### 4.3 Fans and Vents

Remove dust from fans and vents using a small brush or hand held vacuum. Immobilize fan blades to avoid over-speed when using a vacuum.

### 4.4 Sense Leads (When Applicable)

Before cleaning the sense lead clips, ensure the system is disconnected and power to the system has been shut off. Clean the sense leads as required. The acid to which the sense lead clips are exposed during testing must be neutralized often, using a water and baking soda mixture. Brush this mixture onto the sense lead clip, and then rinse well with clean, cool tap water. Dry with a clean, soft cloth.

**NOTE:**

*Some equipment and systems may not be equipped with lead clips.*

### 4.5 Internal Components

The monitor system has no user-replaceable components. Since high voltage exists in most system components, only knowledgeable users should remove the covers or cowling from components (monitor, UPS, etc.) when required. Failure to comply with this restriction could pose a safety hazard and/or void the product warranty.

**WARNING:**

**High voltages exist inside the monitor system components and on the terminals.**

**Calibration must be performed only by technically qualified persons.**

**Observe electrical safety precautions when removing and installing equipment covers and when connecting leads and making adjustments.**

#### **4.6 Shipping, Storage, Normal Use Protection**

Protect the system from physical impact during normal use or storage, and when necessary, provide protection during shipment between test sites.

### **5 Product Overview The BDS–256XL System**

The BDS–256XL system consists of a CM–XL8 Controller Module, DCM–XL48 Data Collection Modules DCMs (and/or DCM–XL48d, please refer to BDS–256XL Dual Reading Battery Diagnostic System Installation Instructions pn 4200–075), and RTM–XLR Resistance Test Modules RTMs. Additional components may include a Personal Computer PC, a cabinet to house the PC and Controller, a LAN adaptor, DCM tower enclosures, and a DCM external power supply.

#### **5.1 Measurement Capabilities**

- ◆ 256 Cells/Modules Per String
- ◆ 8 Strings Maximum
- ◆ Overall Voltage OV
- ◆ 1 Float/Discharge Sensor Per String
- ◆ 10 Temperature Sensors/String–  
2 Maximum Per DCM
- ◆ Cell Resistance  
Intercell Resistance  
– DCM Model Dependent  
Intertier Resistance

#### **5.2 Features**

This section describes standard and optional BDS–256XL System features:

##### **5.2.1 Standard**

- ◆ Auto detects discharges based on Overall Volts OV or Discharge Current DC, and stores data for real time or accelerated time playback,
- ◆ Scans all pertinent battery parameters, such as overall voltage, cell voltages, and current and temperature/optional,
- ◆ Performs a scheduled resistance test of all cells/jars, intercells and intertiers, and stores results for trending analysis,

- ◆ Communicates with an external computer via USB, RS–232, modem, and LAN, and
- ◆ Is SQL server compatible.

### 5.2.2 Optional

- ◆ Is network compatible with a network card,
- ◆ Hall effect current transducer for measuring discharge and float current,
- ◆ Temperature sensor: Electrolyte Probe or Contact Ambient Probe,
- ◆ Monitors up to 16 digital inputs, with a digital I/O card or 8 control outputs,
- ◆ Continuous Load Unit CLU control.

### 5.2.3 Alarm Features

- ◆ 8 control outputs, trigger–able on any alarm event,
- ◆ The monitor may be set to signal if any parameter is outside user–programmed limits, energizes a Form C relay contact, and calls a Central computer to report the alarm condition.
- ◆ The monitor may be set to automatically call the Central computer to report an alarm condition when detected.
- ◆ High and low alarm levels may be programmed on all voltage and temperature parameters, and a high alarm level for resistance.
- ◆ When any parameter goes outside the normal range, the monitor stores the event in memory, the Alarm LED lights, and an alarm relay with a Form C contact energizes.
- ◆ The alarms may be set for latching or non–latching.

## 5.3 Model Number

The BDS–256XL system consists of:

1. CM–XL8 Controller Module,
2. DCM–XL48 Data Collection Modules DCMs (and/or DCM–XL48d), and
3. RTM–XLR Resistance Test Modules RTMs.

Additional components may include a Personal Computer PC, a cabinet to house the PC and Controller, a LAN adaptor, DCM tower enclosures, and a DCM external power supply.

### 5.3.1 CM–XL8 Controller Module Model Number Description

The CM–XL8 Controller model numbers are structured as 1002–nnnxxx, described below. A typical CM–XL8 Controller part number might be 1002–210BDL.

Model Number	
1002–210	4 Amp output for DCM and RTM power

Model Number	
1002-211	10 Amp output for DCM and RTM power
1002-212	20 Amp output for DCM and RTM power
1002-210-230	4 Amp output for DCM and RTM power
1002-211-230	10 Amp output for DCM and RTM power
1002-212-230	20 Amp output for DCM and RTM power
1002-nnnAxx	A = a modem card is installed
1002-nnnBxx	B = a LAN card is installed
1002-nnnCxx	C = Both a modem and LAN are installed
1002-nnnDxx	D = No modem or LAN is installed
1002-nnnxDx	D = a digital I/O card is installed
1002-nnnx x	Blank = no I/O card
1002-nnnxxL	L = an MLC option is installed
1002-nnnxx	Blank = no MLC option

**Figure 1. CM-XL8 Controller Module Model Numbers**

**NOTE:**

Assume 450mA per DCM-XL48 and 1A per RTM-XLR.

### 5.3.2 DCM-XL48 Data Collection Module Model Number Description

Model Number	
1003-100	DCM-XL48 is Combined Reading
1003-101	DCM-XL48 is Dual Reading
1003-102	DCM-XL48 is Dual Reading DCM (field replacement for older units)
1003-103	DCM-XL48 is Combined Reading DCM (field replacement for older units)

**Figure 2. DCM-XL48 Data Collection Module Model Numbers**

Please refer to the BDS-256XL Dual Reading Battery Diagnostic system Installation Instructions Manual pn 4200-075 for further information on DCM-XL48d models.

### 5.3.3 RTM-XLR Resistance Test Module Model Number Description

Model Number	Where Used	Model Number	Where Used
1002-244	48V/68V	1002-279	48V/60V
1002-245	48V/80V	1002-280	24V/28V
1002-246	44V	1002-281	24V
1002-247	21V	1002-282	60V/36V

Model Number	Where Used	Model Number	Where Used
1002-250	36V	1002-283	40V
1002-251	36V/48V	1002-284	48V/24V
1002-253	36V/72V	1002-285	32V
1002-256	48V	1002-286	12V/8V
1002-257	48V/56V	1002-288	36V/32V
1002-258	48V/54V	1002-289	48V/32V
1002-259	46V/38V	1002-290	48V/16V
1002-260	44V/42V	1002-291	36V/42V
1002-261	48V/40V	1002-292	44V/40V
1002-263	46V/50V	1002-293	48V/8V
1002-264	48V/36V	1002-294	48V/24V
1002-265	48V/50V	1002-295	12V
1002-278	48V/72V		

Figure 3. RTM-XLR Resistance Test Module Model Numbers

## 5.4 Materials

### 5.4.1 Standard

## Standard Materials

Description	Photo	Purpose
<p>Sense Lead Harness</p> <p>1101-181-xx</p>		<p>Voltage sense lead connection 24 AWG</p> <p>Refer to the Engineering Drawing Package sent with the system.</p>

Figure 4. Sense Lead Harness

Overall Volts OV/IT  
Cable

1101-182-xx



DCM Overall Volts OV/IT cable assembly—Please refer to wiring schematics that accompanied the equipment as well as drawing BDS-1284-A660.

**Figure 5. DCM Overall Volts Cable**

DCM Temperature  
Connection Sense  
Lead Harness

1101-183-xx

electrolyte  
cable1101-186-xx  
(not shown)





DCM Temperature and Sense Lead connection

Refer to the Engineering Drawing Package sent with the system as well as drawing BDS-1285-A661 and drawing BDS-1293-A669.

**Figure 6. DCM Temperature Connection Sense Lead Harness  
pn 1101-1183-xx**

## Standard Materials

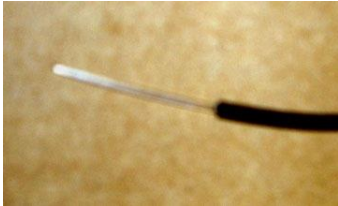
Description	Photo	Purpose
<p>2 Cond 16 GA Black Zip Cord 6002-080</p>		<p>AC power between units, 24VAC connection cord to load module and DCM</p>
<p>Fiber Optic Polishing Kit 3703-015</p>		<p>To polish fiber optic cable</p>
<p>Fiber Optic Cable 3703-006</p>		<p>Communication link between Controller and DCMs</p>

# Standard Materials

Description	Photo	Purpose
-------------	-------	---------

CM-XL8 =  
Controller Module,  
DCM-XL48 = Data  
Collection Module  
DCM, and  
RTM-XLR =  
Resistance Test  
Modules RTMs.



Battery monitoring system

**Figure 10. CM, DCM, RTM =  
BDS-256XL System**

DCM Control  
1100-496-xx



DCM control

**Figure 11. DCM Control**

4 POS/8POS  
Pluggable  
Terminals  
2140-022 (4)  
2140-024 (8)

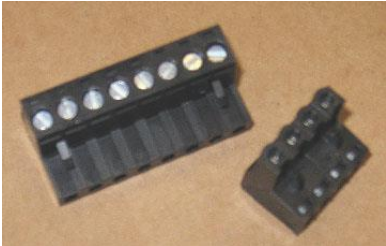

Pluggable screw terminals for power  
and relay connections

**Figure 12. 4 POS – 8 POS Pluggable  
Terminals**



## Standard Materials

Description	Photo	Purpose
-------------	-------	---------

7 ft telephone cable-UL  
6003-010



**Figure 13. 7' Telephone Cable-UL**

Modem/TELCO connection cable

10 GA-5/16 " insulated ring terminal UL  
2800-109  
-used in Inline Fuseholder Assembly  
1100-433UL



**Figure 14. 10 Gauge-5/16" Insulated Ring Term UL**

Ring terminal provides connector interface between current transducer and harness. Refer to BDS-193-A453.

BDS Flex resist w/butt splice  
1100-437BS



**Figure 15. BDS Flex Resist w/Butt Splice**

10K resistor-prevents over current conditions.

Refer to BDS-1251-A640.

**NOTE:**

*The sense lead resistor assemblies include a 10KΩ 1% flameproof resistor that reduces the risk of a short circuit during installation and maintenance*

# Standard Materials

Description	Photo	Purpose
-------------	-------	---------

USB2 Hi-speed  
cable  
2025-108



For system hardware to computer communication.

Figure 16. Exterior USB Cable

30 amp connector  
block-UL  
2102-017



Andersen housing/connector block  
  
Refer to drawing BDS-193-A453.

Figure 17. 30 Amp Connector Block-UL



30 amp contact  
2102-018



Insert pin/contact for housing/connector  
  
Refer to drawing BDS-193-A453.

Figure 18. 30 Amp Contact

## Standard Materials

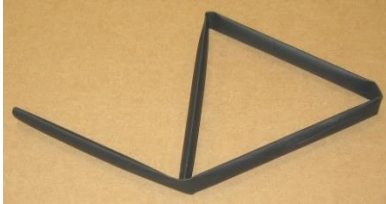
Description	Photo	Purpose
<p>¼" tab washer 2120-028</p>	 <p style="text-align: center;"><b>Figure 19. ¼" Tab Washer</b></p>	<p>Connector interface between harness and cell—Refer to drawing BDS-123-A380.</p> <div style="border: 1px solid orange; padding: 5px; margin-top: 10px;"> <p><i>NOTE:</i> Tab washer size is battery dependent, other sizes such as 3/8" and 5/16" are readily available.</p> </div>
<p>30 amp cartridge fuse 4302-030</p>	 <p style="text-align: center;"><b>Figure 20. 30 Amp Slo-Blo Ceramic Fuse</b></p>	<p>Load step fuse—Please refer to drawing BDS-193-A453.</p>
<p>12 gauge UL1015 red 6002-037</p>	 <p style="text-align: center;"><b>Figure 21. 12 Gauge UL1015 Red</b></p>	<p>Load step wire</p>
<p>¼" heat shrink tubing 2880-004—used in Inline Fuseholder Assembly may have 3/8" heat shrink tubing substituted 2880-005</p>	 <p style="text-align: center;"><b>Figure 22. ¼" Heat Shrink Tubing</b></p>	<p>Helps insulate connection</p>

# Standard Materials

Description	Photo	Purpose
-------------	-------	---------

Power Cord  
6003-008 = US,  
6003-006 = Euro,  
6003-007 = UK



Power for the Controller

Figure 23. Controller Power Cord(s)

DCM Inline  
Fuseholder  
Assembly  
1100-433UL

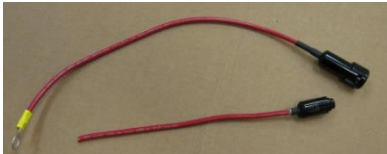

Inline fuseholder

Refer to drawing BDS-193-A453

Figure 24. Inline Fuseholder Assembly

RS-232 serial cable  
2025-117



DB9 computer communication cable

Figure 25. RS-232 Cable

5.4.2 Optional

## Optional Materials

Description	Photo	Purpose
-------------	-------	---------

FCCP\*\*  
5610-051



Float current measurement transducer for a single string. Please refer to drawings BDS-1283-A659.

**Figure 26. Multitel Float Charging Current Probe**

Power Source  
4000-026\*\*



Powers FCCP from wall outlet.

**Figure 27. Power Source For FCCP pn 4000-026**



**NOTE:**

*For best results follow the manufacturer's instructions, and please refer to BDS-1283-A659 for FCCP assembly. Part number 4000-026 is to be used for power with the assembly of the FCCP.*



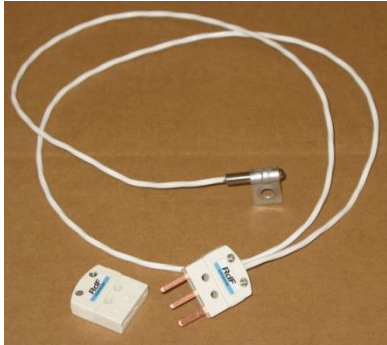

*Part number 5610-050 is for dual strings and would include one more clamp on the probe.*

*\*\*The Kit that includes the FCCP, float cable/CT harness and power supply is available: KIT-1101-185. 4000-026 and 1101-185-xx Float CT Cable are included in the kit.*

## Optional Materials

Description	Photo	Purpose
<p>Ambient temperature probe 2900-029</p>		<p>Temperature probe that hangs free for ambient temperature measurement. Refer to drawing BDS-1285-A661.</p>
<p>Electrolyte temperature probe 2900-010</p>		<p>Teflon coated probe, may be immersed in a flooded cell. Refer to drawing BDS-1285-A661.</p>
<p>2000 Amp CT 5610-006</p>		<p>Use Drawing BDS-1282-A658- PHOTOS VARY DEPENDING UPON MODEL(S) CHOSEN UP TO 3000 AMPS</p>

## Optional Materials

Description	Photo	Purpose
<p>1101-185-xx Float CT Cable</p>		<p>Float current cable/CT Cable</p> <p>BDS-1283-A659 Float Connections BDS-256XL-1101-185-xx</p> <p>and</p> <p>Current transducer cable, please refer to Drawing BDS-1282-A658 for CT connection</p>
<p>Or 1101-184-xx CT Cable</p>		<p><b>Figure 31. Float/CT Cable</b></p>
<p>female disconnect adapter 2800-129</p>		<p>Voltage sense splitters where single tab needs to multi connect</p> <div style="border: 2px solid red; padding: 5px; margin-top: 10px;"> <p> <b>WARNING:</b> Never use for load lead wire.</p> </div>

**Figure 32. CT Cable**





**Figure 33. Female Disconnect Adapter**

- ◆ Internal digital I/O card for monitoring 16 digital inputs or controlling eight control outputs.
- ◆ Continuous Load Unit CLU control.

### 5.5 Required Tools

The following tools or equivalent are necessary for BDS–256XL System installation:

## TOOLS

Description	Photo	Purpose
Anderson Power Products crimping tool 1309G2 (was 1351G1) Vertiv pn 5400–003	 <p><b>Figure 34. Anderson Crimping Tool 1309G2</b></p>	For crimping 30 amp Anderson connectors. Available from Online Electronics at 800 335–5111 <a href="http://www.onlineelec.com">www.onlineelec.com</a> or U.S. Airmotive, Inc. at 305 885–4991 <a href="http://www.usairmotive.com">www.usairmotive.com</a> .)
Panduit CT–260 crimper Vertiv pn 5400–002	 <p><b>Figure 35. Panduit CT–260 Crimper</b></p>	For crimping parallel splices
Panduit CT–1525 crimper Vertiv pn 5400–007	 <p><b>Figure 36. Panduit CT–1525 Crimper</b></p>	For crimping ring terminals, please refer to drawing BDS–1251–A640
Panduit CT–1550 crimper Vertiv pn 5400–008	 <p><b>Figure 37. Panduit CT–1550 Crimper</b></p>	For crimping ring terminals, please refer to drawing BDS–1251–A640
Thomas and Betts crimper WT–111–M	 <p><b>Figure 38. Thomas &amp; Betts WT–111–M For Crimper</b></p>	For crimping fuse holders



## TOOLS

Description	Photo	Purpose
<p>#2 Phillips–head screwdriver with insulated handle</p>	 <p><b>Figure 39. #2 Phillips–Head Screwdriver With Insulated Handle</b></p>	<p>For mounting BDS components, and for removing or attaching panels</p>
<p>Digital Voltmeter</p>	 <p><b>Figure 40. Digital Voltmeter</b></p>	<p>Checking voltage.</p>
<p>Molex Crimp Tool HTR 2445 A pn 5400–006</p>	 <p><b>Figure 41. Molex Crimp Tool</b></p>	<p>For crimping specific Molex pins on specific FCCPs</p>
<p>Flat–head stubby screwdriver</p>	 <p><b>Figure 42. Flat–Head Stubby Screwdriver</b></p>	<p>For attaching ground wire</p>

# TOOLS

Description	Photo	Purpose
-------------	-------	---------

Computer/Printer

LT pn 2025-058

DT pn 2025-054



Figure 43. Computer/PC

To review data, monitor alarms etc.

BMDM Software

pn 2027-001



Figure 44. BMDM Software Icon

Help to monitor the systems and capture data for reporting, etc.

Printer for the PC

Pn 2025-127

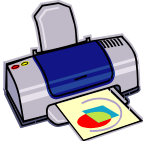

Figure 45. Inkjet Printer

Printing reports from data/PC.

## 5.6 Building Management System Integration

The BDS–256XL System can connect to building management systems. This integration requires writing software that can communicate with the BDS. The communication protocol is MODBUS ASCII. A register map can be obtained by downloading it from <http://www.vertivco.com>.

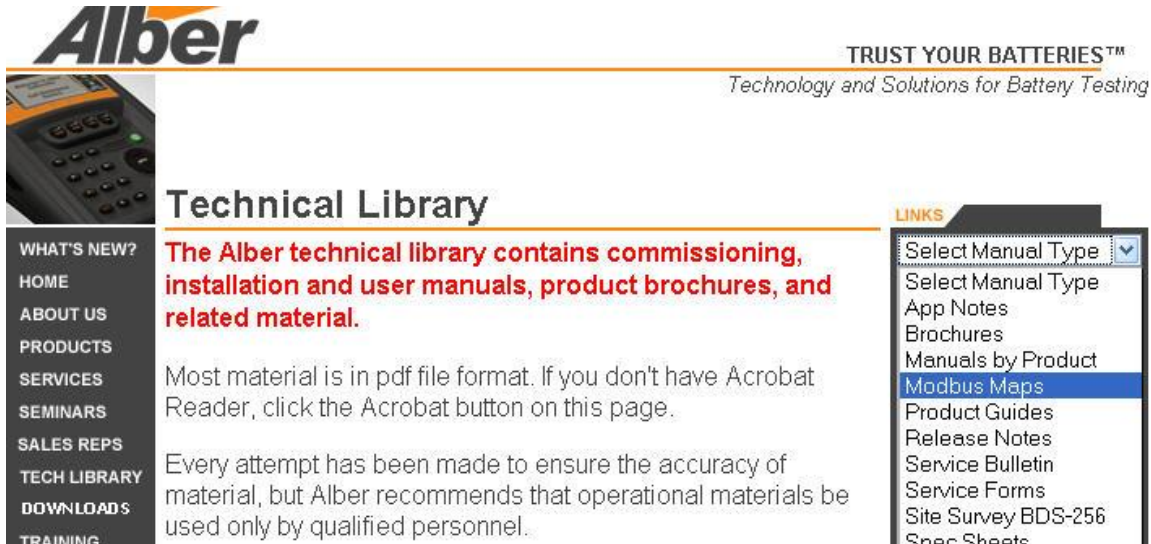

Figure 46. Website

Building Management System Integration connects via LAN RJ–45 or local port located on the rear panel. The only connections made are TX–Pin 2, RX–Pin 3, and GND–Pin 5.

## 5.7 Panel Controls And Indicators

This section describes the front and rear panels of the components that comprise the BDS–256XL system. Additional descriptions may appear elsewhere in this manual or in related manuals.

**NOTE:**

Indicator colors are:

**(R)ED,**

**(Y)ELLOW,**

**(G)REEN.**

The BDS–256XL System consists of:

1. CM–XL8 Controller Module,
2. DCM–XL48 Data Collection Modules DCMs (and/or DCM–XL48d) and
3. RTM–XLR Resistance Test Modules RTMs.

Additional components may include a Personal Computer PC, a cabinet to house the PC and Controller, a LAN adaptor, DCM tower enclosures, and a DCM external power supply.

### 5.7.1 CM-XL8

#### 5.7.1.1 Front Panel Connectors

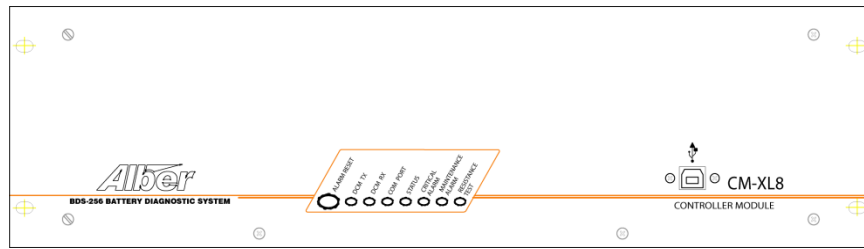
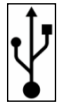

Figure 47. Controller Front Panel With USB CM-XL8

**LOCAL PORT**



USB port. Connects to a laptop computer

#### 5.7.1.2 Front Panel Controls/Alarm Reset Switch

**ALARM RESET** Switch

During normal operation, clears latched alarms. If held during power up, clears existing names in the BDS, disables alarms, disables dial out, and resets the password to alber.

#### 5.7.1.3 Front Panel Indicators/DCM TX /RX/COM/Status/Alarms And Test

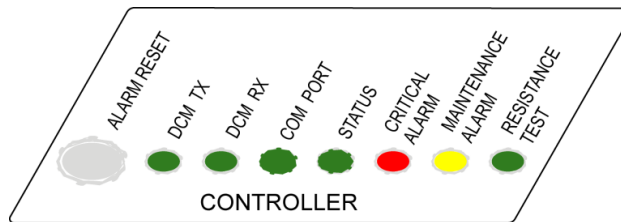

Figure 48. CM-XL8 Front Panel Indicators LEDs Explained

**DCM TX (G)REEN**

Flashes during fiber optic transmit

**DCM RX(G)REEN**

Flashes during fiber optic receive

**COM PORT (G)REEN**

Flashes to indicate communication via LAN port or an incoming call

**STATUS (G)REEN**

Flashes during normal operating conditions

**CRITICAL ALARM (R)ED**

**Critical alarm detected**

**MAINTENANCE ALARM (Y)ELLOW**

Maintenance alarm detected

**RESISTANCE TEST (G)REEN**

Performing a manual or automatic resistance test

5.7.1.4 Rear Panel Connectors

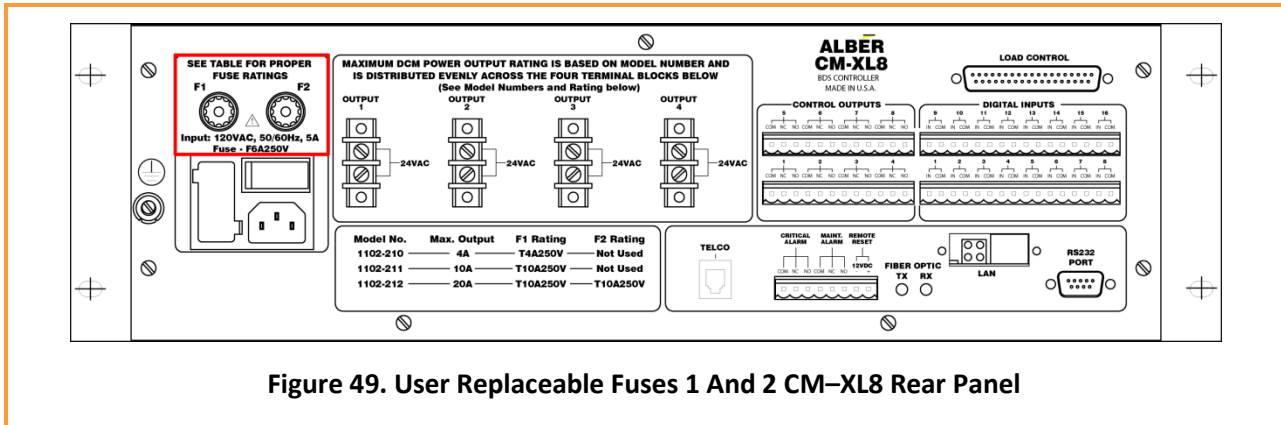

Figure 49. User Replaceable Fuses 1 And 2 CM-XL8 Rear Panel

5.7.1.4.1 Fuses

T10A250V 2 user replaceable fuses. Values based on CM-XL8 model number. See table below.

F1 and F2 Fuse Ratings Table*			
Model Number	Max. Output	Fuse F1 Rating	Fuse F2 Rating
1102-210	4A	T4A250V	Not Used
1102-211	10A	T10A250V	Not Used
1102-212	20A	T10A250V	T10A250V

Figure 50. F1 And F2 Fuse Ratings Table\*

**\* ⚠ WARNING:**

This table is provided as a reference only and may not agree with the actual capacity of your system. The user must refer to the table on the rear panel of the CM-XL8 to determine the actual fuse values required by the system and the system output capabilities.

5.7.1.4.2 Input/AC Power Block

- ◆ 115VAC 50/60Hz or 230VAC 50/60Hz (Optional)
- ◆ User replaceable fuse and receptacle for AC power cord
- ◆ Power switch for system on/off

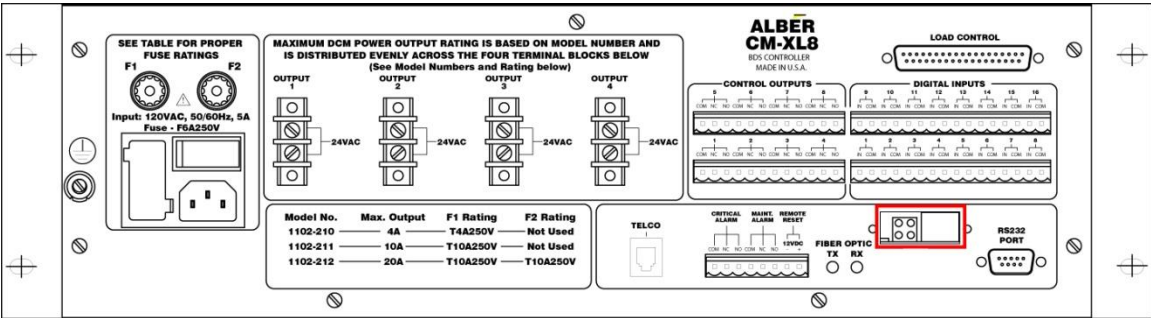

Figure 51. CM-XL8 Input/AC Power Block

5.7.1.4.3 Output/Load Control/Control Outputs/Digital Inputs

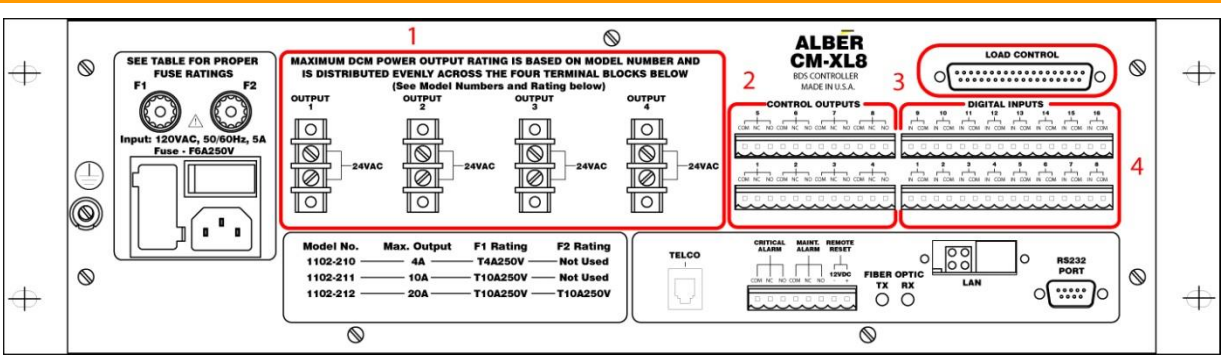
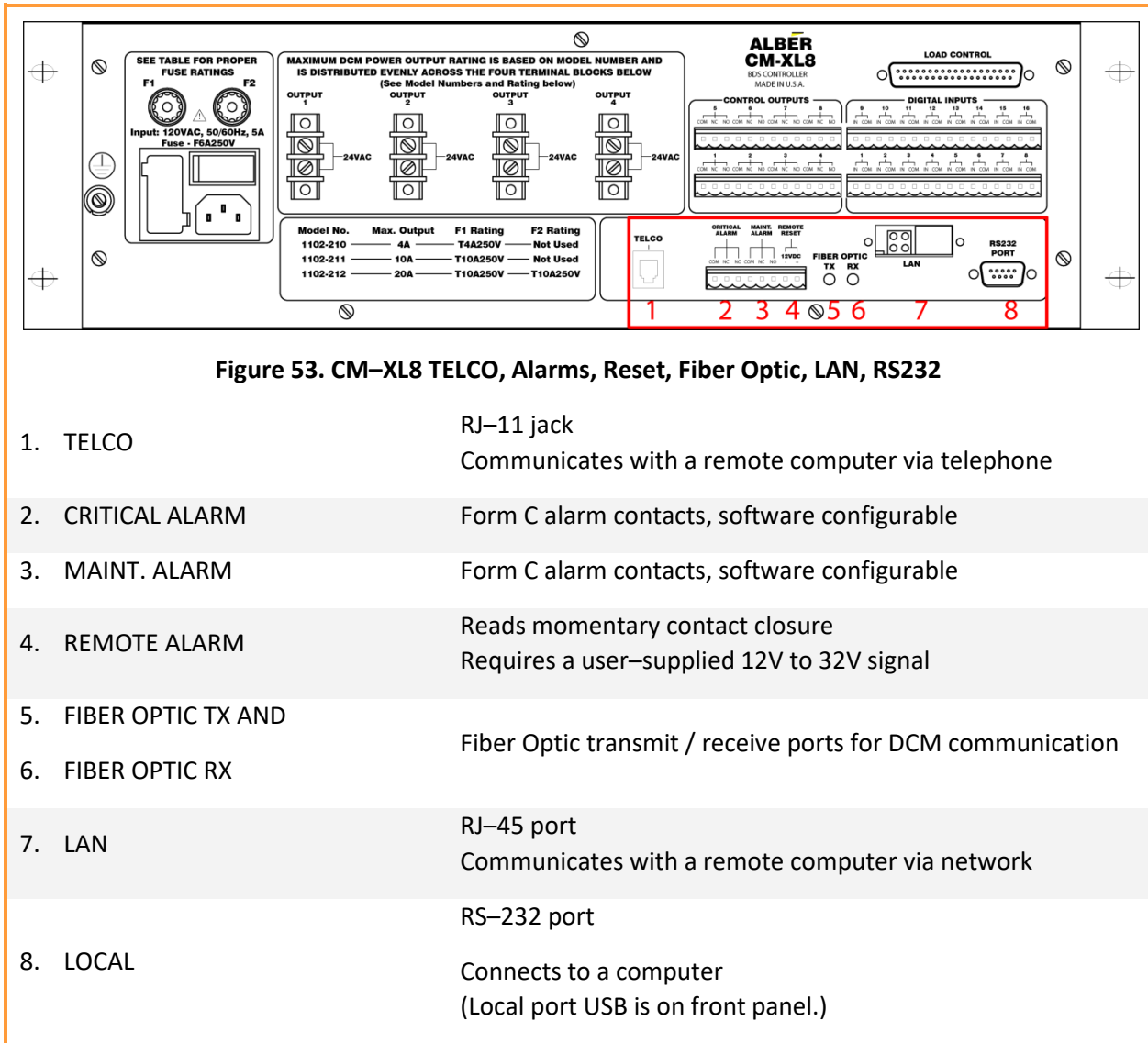

Figure 52. CM-XL8 Output/Load Control/Control Outputs/Digital Inputs

- |    |                            |   |
|----|----------------------------|---|
| 1. | 4 PAIRS OF SCREW TERMINALS | Provide 24VAC.  |
| 2. | LOAD CONTROL               | Connects to a Vertiv CLU Series load bank (not a Resistance Test Module). |
| 3. | CONTROL OUTPUTS 1 TO 8     | Form C contacts for controlling external devices.                         |
| 4. | DIGITAL INPUTS 1 TO 16     | Optically isolated inputs for sensing contact closures.                   |



5.7.2 DCM-XL48

5.7.2.1 Front Panel Indicators

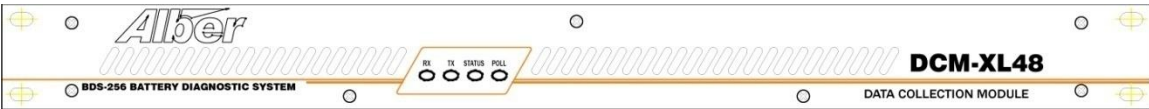

Figure 54. DCM-XL48 Front Panel

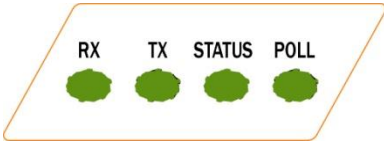

Figure 55. DCM-XL48 Front Panel Indicators Explained

<b>RX (G)REEN</b>	Flashes during fiber optic receive.
<b>TX (G)REEN</b>	Flashes during fiber optic transmit.
<b>STATUS (G)REEN</b>	Flashes during normal operating conditions.
<b>POLL (G)REEN</b>	Flashes during polling from Controller.

5.7.2.2 Rear Panel Connectors

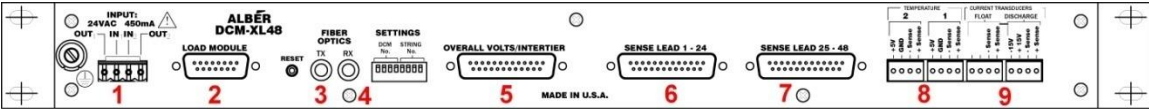

Figure 56. DCM-XL48 Rear Panel Connectors Explained

1. 24VAC 450MA POWER INPUT / OUTPUT	A 4-pin connector for daisy-chaining 24VAC to other DCMs.
2. LOAD MODULE	Control port for Resistance Test Module communication.
3. TX and 4. RX	Fiber Optic transmit / receive ports for communicating with a Controller or other DCMs.
5. OVERALL VOLTS/INTERITER	DB-25 port. Connects Overall Voltage and Discharge sense leads when connecting a shunt.
6. SENSE LEAD 1 TO 24,	DB-25 ports.
7. SENSE LEAD 25 to 48	Connects voltage sense leads to the batteries.



- |  |  |
|--|--|
| 8. TEMPERATURE 1 and 2                     | 4 pin.<br>For sense and power connections for temperature sensors.                             |
| 9. CURRENT TRANSDUCERS/FLOAT AND DISCHARGE | 4 pin.<br>For sense and power connections for float current and discharge current transducers. |

5.7.2.3 Rear Panel Controls

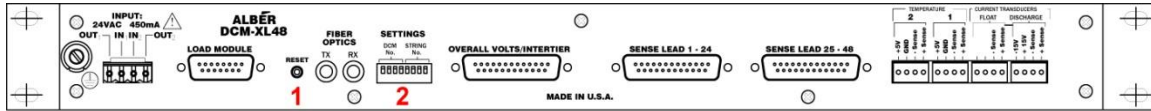

Figure 57. DCM–XL48 Rear Panel Controls

- |                           |   |
|---------------------------|---|
| 1. RESET                  | Push button to reset the DCM.                 |
| 2. DCM NO. AND STRING NO. | DIP switches. Sets DCM/string identification. |

5.7.3 RTM–XLR

5.7.3.1 Front Panel Indicators

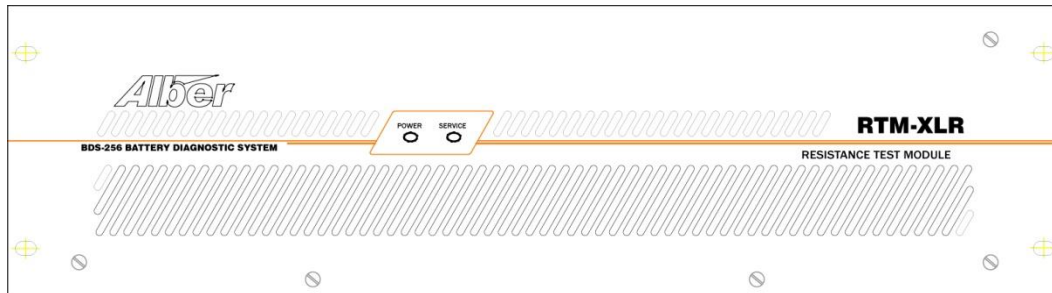

Figure 58. RTM–XLR



Figure 59. RTM–XLR LEDs

- |                  |   |
|------------------|---|
| 1. POWER (G)REEN | 24VAC power is applied  |
| 2. SERVICE (R)ED | Unit requires factory service, usually because internal temperature exceeded specifications |

### 5.7.3.2 Rear Panel Connectors

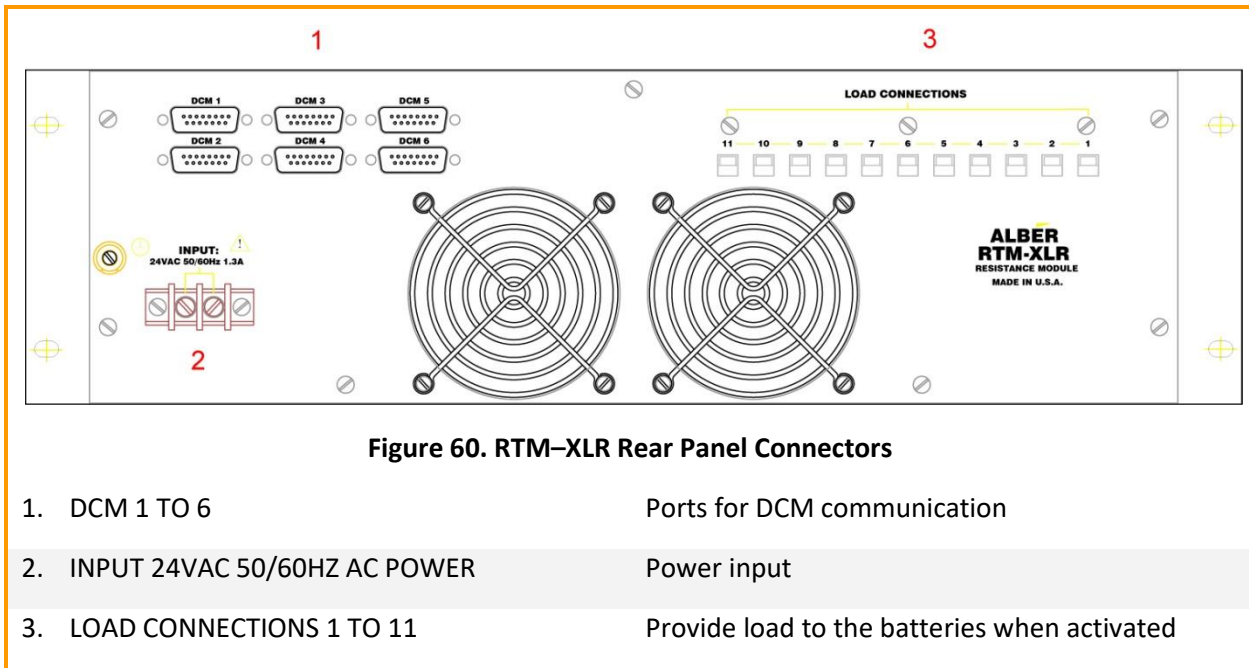

## 5.8 Specifications

### 5.8.1 BDS–256XL System Specifications

#### 5.8.1.1 Inputs

- ◆ Cell voltage:
  - NICADS,
  - 2V,
  - 4V,
  - 6V,
  - 8V,
  - 12V and
  - 16V ranges.
- ◆ 5 intertier resistance channels per DCM.  
Optional 6 DCMs total, with 15 intertiers per string.
- ◆ String voltage.
- ◆ 10 (Maximum) temperature channels.\* 2 per DCM
- ◆ Discharge current.\*
- ◆ Float current.\*
- ◆ 16 digital inputs (Optional).

\*Optional temperature and current transducers are required. Optional temperature transducer can be contact type or immersible.

**5.8.1.2 Outputs**

- ◆ Eight control outputs from the Controller (Optional)

**5.8.1.3 Parameters / Features**

- ◆ Number of cell channels: Up to 8 strings of 256 cells per string  
Up to 6 DCM-XL48's units per string

**5.8.1.4 Measurement Range / Tolerances**

◆ Intertier resistance:	0 to 5mΩ, 5% of reading ±5μΩ		
	2V range	0-4V	0.1% ±1mV
	4V range	0-8V	0.1% ±2mV
	6V range	0-8.5V	0.1% ±2mV
◆ Cell voltage:	8V range	0-10V	0.1% ±10mV
	12V range	0-16V	0.1% ±10mV
	16V range	0-20V	0.1% ±10mV
◆ Cell resistance:	0 to 32,000μΩ, 5% of reading ±1μΩ		
◆ Intercell Resistance:	0 to 500μΩ, 0.25% of reading ±5μΩ Optional harness and relay modifications required.		
	0 to 80.00 volts, 0.2% of reading ±0.02 volts		
◆ String Voltage:	0 to 400.0 volts, 0.2% of reading ±0.1 volts 0 to 600.0 volts, 0.2% of reading ±0.2 volts		
◆ *Discharge Current:	0 to 4000A ±5% of full scale		
◆ *Float Current:	0 to 5000mA ±50mA		
◆ *Temperature:	0°C to 80°C (32°F to 176°F), ±1°C.		
*Optional Current Transducer CT required.			
*Transducer accuracy affects overall current/temperature reading accuracy.			

**5.8.1.5 Operating Environment**

- ◆ Temperature range: 5°C to 40°C  
41°F to 104°F
- ◆ Humidity range: 0% to 80% RH (non condensing) at 5°C to 31°C  
0% to 50% RH (non condensing) at 32°C to 40°C
- ◆ Indoor use only

- ◆ Installation category II
- ◆ Pollution degree 2
- ◆ Altitude 0 to 2000 meters above sea level



**WARNING:**

A BDS–256XL system, comprising of a CM–XL8 Controller, DCM–XL48's, and RTM–XLR Resistance Test Modules, may be mounted in a 19" wide rack enclosure. If using such a rack enclosure, be certain it is properly earth grounded and adequate ventilation is provided to prevent equipment from overheating. The receptacle for the AC cord from the cabinet must have protective earth connection, three prong plug. Never defeat the use of the earth connection prong.

### 5.8.2 Cabinet Specifications

The BDS–256XL System consists of:

1. CM–XL8 Controller Module,
2. DCM–XL48 Data Collection Modules DCMs (and/or DCM–XL48d) and
3. RTM–XLR Resistance Test Modules RTMs.

The operating environment described on this page applies to these units as well.

#### 5.8.2.1 Power

- ◆ 115VAC  $\pm$ 10% 60Hz,  
12 amps maximum.

#### 5.8.2.2 Model

Part number 1100–262, where the computer, monitor, UPS, Controller, DCM, and Resistance Test Module may be mounted within as required.

#### 5.8.2.3 Maximum Dimensions

- ◆ 24" wide x 26" high x 37" deep with folding keyboard tray down

#### 5.8.2.4 Installation Requirements

- ◆ Only equipment that is part of the BDS system should be installed in the BDS cabinet.
- ◆ The 4 corners of the cabinet must be securely bolted to the floor.

#### 5.8.2.5 Operating Environment

- ◆ Temperature range: 5°C to 40°C  
41°F to 104°F
- ◆ Humidity range: 0% to 80% RH (non condensing) at 5°C to 31°C  
0% to 50% RH (non condensing) at 32°C to 40°C
- ◆ Indoor use only
- ◆ Installation category II
- ◆ Pollution degree 2
- ◆ Altitude 0 to 2000 meters above sea level

**WARNING:**

A BDS–256XL system, comprising of a CM–XL8 Controller, DCM–XL48's, and RTM–XLR Resistance Test Modules, may be mounted in a 19" wide rack enclosure. If using such a rack enclosure, be certain it is properly earth grounded. The receptacle for the AC cord from the cabinet must have protective earth connection (three prongs). Never defeat the use of the earth connection prong.

### 5.8.3 CM–XL8 Controller Specifications

#### 5.8.3.1 Power

- ◆ 115VAC/230VAC  $\pm 10\%$  60Hz,  
5 amps maximum for a configuration of 8 strings of 256 cells

#### 5.8.3.2 Fuses

- ◆ One 500mA SB and one 2A SB  
On PC board.  
Not user replaceable.
- ◆ Fuse #1 and #2  
Rear panel.  
For values, please refer to the model number description tables in section 1.3 Model Number on page 9.
- ◆ One 5A for 115VAC or  
2.5A for 230VAC, ABC or equivalent.  
AC power block–rear panel.

#### 5.8.3.3 Inputs

- ◆ Remote alarm reset.  
User–supplied 12V signal, 15mA maximum  
Momentarily applying voltage initiates the reset action
- ◆ Digital input (optional). Sixteen 12V, 15mA maximum.  
For monitoring external dry contacts.

#### 5.8.3.4 Outputs

- ◆ 24VAC power for up to four DCMs and Resistance Test Modules.
- ◆ Alarm contacts.  
2 Form C, 2A at 30VDC.  
One for critical alarm; one for maintenance alarm.
- ◆ User programmable relay contacts (Optional).  
Eight Form C, 2A at 30VDC
- ◆ LEDs (one each):  
(G)REEN DCM TX transmit,  
(G)REEN DCM RX receive,

(G)REEN com port,  
(G)REEN status,  
(R)ED critical alarm,  
(Y)ELLOW maintenance alarm, and  
(G)REEN resistance test.

#### 5.8.3.5 Communication

- ◆ Modbus protocol, ASCII, and SNMP to PC, Vertiv proprietary to DCMs.
- ◆ Local port, USB connector–front panel
- ◆ Local port, RS–232 DB–9 connector–rear panel
- ◆ LAN port, RJ–45–optional–rear panel
- ◆ RJ–11 Telco line, internal 14.4Kbs modem–rear panel
- ◆ Fiber optic ports–DCM communication link

#### 5.8.3.6 Data Storage

- ◆ SRAM 8 MB nonvolatile memory for all configuration settings and data
- ◆ Flash memory for firmware upgrades

#### 5.8.3.7 Control Switches

- ◆ Power on/off:  
Main DCM–XL48 power switch on rear panel of CM–XL8 Controller module.  
Rocker switch.
- ◆ Alarm reset:  
Alarm Reset switch on front panel of CM–XL8 Controller module.  
Momentary push button.

#### 5.8.3.8 Tolerances

- ◆ Tolerances are described in the BDS–256XL Systems Specifications section 1.8.1.4 Measurement Range / Tolerances on page 20–21.

#### 5.8.3.9 Packaging

- ◆ 19" rack mount

#### 5.8.3.10 Dimensions

- ◆ 19"W x 8"D x 5"H
- ◆ 16 lbs.

#### 5.8.3.11 Agencies

- ◆ UL listed. File number E212234
- ◆ CE approved

## 5.8.4 DCM–XL48 Specifications

### 5.8.4.1 Power

- ◆ 24VAC  $\pm$ 10%,  
0.5A maximum

### 5.8.4.2 Fuses

- ◆ One 0.5A SB and one 0.75A SB  
On PC board  
Not user replaceable

### 5.8.4.3 Inputs Rear Panel

- ◆ 48 cell voltage channels
- ◆ 5 intertier channels
- ◆ 2 temperature channels  
Optional temperature transducer required
- ◆ One discharge current channel  
Optional current transducer required
- ◆ One overall voltage channel (Optional)

### 5.8.4.4 Outputs Front Panel

- ◆ LEDs (one each):  
(G)REEN DCM TX transmit,  
(G)REEN DCM RX receive,  
(G)REEN status, and  
(G)REEN poll

### 5.8.4.5 Outputs Rear Panel

- ◆ +15VDC, –15VDC power output (Optional) for discharge current transducer
- ◆ Resistance Test Module control cable output

### 5.8.4.6 Combined Input / Output Connectors Rear Panel

- ◆ 24VAC
- ◆ 2 Fiber Optic Ports

### 5.8.4.7 Communications

- ◆ Fiber Optic  
Vertiv Proprietary.

### 5.8.4.8 Data Storage

- ◆ E<sup>2</sup> nonvolatile memory for setup
- ◆ Flash memory for firmware upgrade



#### 5.8.4.9 Control Switches Rear Panel

- ◆ Reset switch
- ◆ DCM addressing: PC board mounted DIP switches in DCM

#### 5.8.4.10 Tolerances

- ◆ Tolerances are described in section 5.8.1.4 Measurement Range / Tolerances on page 33.
- ◆ Packaging
- ◆ 19" rack mount

#### 5.8.4.11 Dimensions

- ◆ 19"W x 10"D x 1.75"H
- ◆ 6 lbs

#### 5.8.4.12 Agencies

- ◆ UL listed. File number E212234
- ◆ CE approved

### 5.8.5 RTM–XLR Resistance Test Module Specifications

#### 5.8.5.1 Power

- ◆ 24VAC  $\pm 10\%$ ,  
1A maximum

#### 5.8.5.2 Fuses

- ◆ Two 0.5A SB  
On PC board  
Not user replaceable

#### 5.8.5.3 Inputs–Rear Panel

- ◆ One 24VAC
- ◆ 6 load control cable connectors for DCM 1 to DCM 6
- ◆ 11 load connections

#### 5.8.5.4 Outputs–Front Panel

- ◆ LEDs (one each):  
(G)REEN power and  
(R)ED service

#### 5.8.5.5 Tolerances

- ◆ Tolerances are described in section 5.8.1.4 Measurement Range / Tolerances on page 33.

#### 5.8.5.6 Packaging

- ◆ 19" rack mount

#### 5.8.5.7 Dimensions

- ◆ 19"W x 12"D x 5"H
- ◆ 16 lbs.

#### 5.8.5.8 Agencies

- ◆ UL listed. File number E212234
- ◆ CE approved

**WARNING:**

**Only install equipment that is part of the BDS system into the BDS cabinet.**

#### 5.8.5.9 Wiring

**WARNING:**

**The BDS system is designed to connect to UPS systems that are 600VDC or less and a maximum of 300V with respect to earth ground. Verify the voltage with respect to earth ground before connecting the system. Do this by measuring the voltage from each battery post referenced to earth ground. The voltage cannot exceed 300V. Do not defeat the use of the earth connection prong.**

A BDS–256XL system, which includes a CM–XL8 Controller Module, DCM–XL48 Data Collection Module, and RTM–XLR Resistance Test Modules, may be mounted in a 19" wide rack in a cabinet. If using a cabinet, the user must ground the cabinet and installed equipment. The cabinet has several ground lugs; at least one must be connected to earth ground.

The DCM and Resistance Test Module have protective earth grounding connections that the user must connect to earth ground using 10AWG copper wire.

The receptacle for the AC cord from the cabinet must have protective earth connection (three prongs).

When connecting equipment via modem to a telephone line, use a minimum 26AWG TELCO line cord.

**NOTE:**

*Drawings in this manual may be for reference only or superseded by later drawings. For the latest information, refer to the drawings supplied with the system.*

## 6 Before System Installation

### 6.1 Required Drawings

**IMPORTANT NOTE:**

*The following drawings are required for BDS–256XL System installation. The drawings in this manual may not be the most recent revision and are included for reference only. Refer to the Engineering Drawing Package included with your system for the newest drawings.*

Title	Number
Quick Connect Sense / Load Leads, BDS.	BDS–123–A380
Quick Connect Post Clip Leads, BDS.	BDS–163–A424
600V Fused Load Lead, BDS.	BDS–193–A453
Fabrication Detail, Resistor Lead Assembly, BDS.	BDS–1251–A640
General Assembly, RTM–XLR, Resistance Test Module.	BDS–1277–B1202
General Assembly, CM–XL8, Controller.	BDS–1278–B1203
General Assembly, DCM–XL48, Data Collection Module.	BDS–1279–B1204
Current Transducer Connection, DCM–XL48.	BDS–1282–A658
Current Transducer / Float Current Connections, DCM–XL48.	BDS–1283–A659
Overall Voltage / Intertier Connections, DCM–XL48.	BDS–1284–A660
Temperature Connections, DCM–XL48.	BDS–1285–A661
Sub Assembly Electrolyte Temperature Cable.	BDS–1293–A669
Example BDS–256XL to 240 2V Cell Battery Connections.	BDS–2411–D1775
Example BDS–256XL to 40 12V Module Battery Connections.	BDS–2420–C958

**Figure 61. Required Drawings**

### 6.2 System Configuration

The BDS–256XL can accommodate virtually any battery configuration. The following list describes the more commonly used BDS–256XL configurations.

Configuration	Description
BDS–256–1x98x1	1 string of 98–1v cells in series
BDS–256–1x104x1	1 string of 104–1v cells in series

Configuration	Description
BDS-256-1x58x2	1 string of 58-2v cells in series
BDS-256-1x108x2	1 string of 108-2v cells in series
BDS-256-1x122x2	1 string of 122-2v cells in series
BDS-256-1x180x2	1 string of 180-2v cells in series
BDS-256-1x182x2	1 string of 182-2v cells in series
BDS-256-1x184x2	1 string of 184-2v cells in series
BDS-256-1x188x2	1 string of 188-2v cells in series
BDS-256-1x192x2	1 string of 192-2v cells in series
BDS-256-1x198x2	1 string of 198-2v cells in series
BDS-256-1x210x2	1 string of 210-2v cells in series
BDS-256-1x216x2	1 string of 216-2v cells in series
BDS-256-1x220x2	1 string of 220-2v cells in series
BDS-256-1x232x2	1 string of 232-2v cells in series
BDS-256-1x234x2	1 string of 234-2v cells in series
BDS-256-1x236x2	1 string of 236-2v cells in series
BDS-256-1x238x2	1 string of 238-2v cells in series
BDS-256-1x239x2	1 string of 239-2v cells in series
BDS-256-1x240x2	1 string of 240-2v cells in series
BDS-256-1x241x2	1 string of 241-2v cells in series
BDS-256-1x244x2	1 string of 244-2v cells in series
BDS-256-1x246x2	1 string of 246-2v cells in series
BDS-256-1x252x2	1 string of 252-2v cells in series
BDS-256-1x89x4	1 string of 89-4v modules in series
BDS-256-1x90x4	1 string of 90-4v modules in series
BDS-256-1x120x4	1 string of 120-4v modules in series
BDS-256-1x121x4	1 string of 121-4v modules in series

Configuration	Description
BDS-256-1x122x4	1 string of 122-4v modules in series
BDS-256-1x123x4	1 string of 123-4v modules in series
BDS-256-1x60x6	1 string of 60-6v modules in series
BDS-256-1x64x6	1 string of 64-6v modules in series
BDS-256-1x78x6	1 string of 78-6v modules in series
BDS-256-1x80x6	1 string of 80-6v modules in series
BDS-256-1x81x6	1 string of 81-6v modules in series
BDS-256-1x60x8	1 string of 60-8v modules in series
BDS-256-1x61x8	1 string of 61-8v modules in series
BDS-256-1x16x12	1 string of 16-12v modules in series
BDS-256-1x27x12	1 string of 27-12v modules in series
BDS-256-1x30x12	1 string of 30-12v modules in series
BDS-256-1x31x12	1 string of 31-12v modules in series
BDS-256-1x32x12	1 string of 32-12v modules in series
BDS-256-1x33x12	1 string of 33-12v modules in series
BDS-256-1x34x12	1 string of 34-12v modules in series
BDS-256-1x36x12	1 string of 36-12v modules in series
BDS-256-1x40x12	1 string of 40-12v modules in series
BDS-256-1x42x12	1 string of 42-12v modules in series

Figure 62. BDS-256XL Configuration Options

### 6.3 Location Consideration

Vertiv creates a customer drawing package that contains a system drawing with site specific information. Refer to this package and verify all components are available before starting installation.

#### 6.3.1 Power



**WARNING:**

**Do not energize the cabinet or any component with battery voltage until after the installation is complete.**

The electrical service required is less than 15A at 115VAC or 7.5A at 230VAC.

### 6.3.2 Physical Mounting

If using a computer and cabinet, place the cabinet where it will be permanently mounted. Keep the back of the cabinet accessible for servicing. Prepare the computer and cabinet, if included, and the Controller. This includes unpacking, mounting, and connecting the modules.

#### 6.3.2.1 Ballast For Cabinet

Fill the container at the bottom of the cabinet with ballast. This provides stability to help prevent the cabinet from tipping over. The recommended ballast is all-purpose sand (Sure-Mix® All Purpose Sand or equivalent) available at most home improvement stores.

#### 6.3.2.2 Cabinet Wiring/UPS

Pass the AC power cord for the power strip mounted inside the cabinet through the lower left hole and plug it into a UPS-protected outlet once installation is complete. If using an internally mounted Uninterruptible Power Supply UPS, plug the power strip AC cord into the UPS, pass the UPS power cord through the hole, and plug it into an AC outlet once installation is complete.

### 6.3.3 Check Service Access

Mount the DCMs close to the battery, making sure they are accessible for servicing.

### 6.3.4 Maximum Wire And Cable Lengths

Install an insulated wire tray along the length of each battery tier, making sure it does not interfere with cell replacement. Install the sense leads, test current leads, 24VAC cable, and Runs of wire, cable, and fiber optic cable have length limitations as follows:



#### **CAUTION:**

*The maximum length for each sense lead, resistance test cable, and external load control cable is 100 feet (≈30.5 meters).*

### 6.3.5 Fiber Optic Cable And DCM Communication Information

The DCMs communicate with the Controller via fiber optic cable and form a communication ring network.

#### **NOTE:**

*The maximum length of standard plastic fiber optic cable that may be used is 250 feet or 76 meters.*

*Transmit TX/FO on the Controller connects to Receive RX/FO on a DCM. Transmit on this DCM connects to Receive on the next DCM, and so on until Transmit on the last DCM returns to Receive on the Controller.*

**IMPORTANT NOTE:**

*Unlike the requirement for connecting DCMs to battery strings, the string and address assignments on the DCM nameplates do not determine the order in which DCMs are connected within the fiber optic ring.*

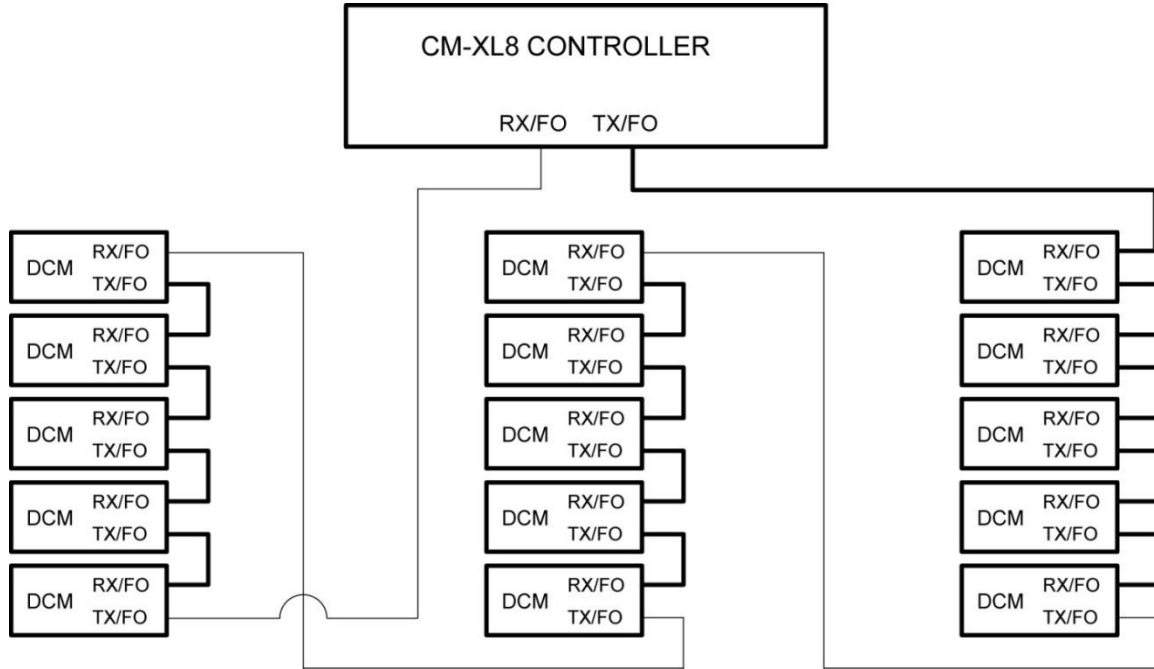

**Figure 63. DCM Fiber Optic Connections**

A pair of 16 AWG wires, supplying 24VAC power, connects from the Controller to the Resistance Test Module and to the DCMs of each string. There are four 24 volt output connectors on the Controller. The first two connectors can supply a combined total of 10 amps, and the last two can supply a combined total of 10 amps. \*Each DCM consumes 450mA. \*Controller model dependent.



**WARNING:**

**Do not exceed the total current for either group of connections.**

When using fiber optic cable, locate the cabinet so the fiber optic cable run does not exceed 250 feet or 76 meters from the Controller to the DCM. Look at the system drawing and the physical facility and determine how the fiber optic and power cables to the DCMs should exit the cabinet. Two 1½" holes, through which wires may be passed, are on the left side of the cabinet. When installing the fiber optic cable, do not bend the cable in a radius tighter than 35mm.

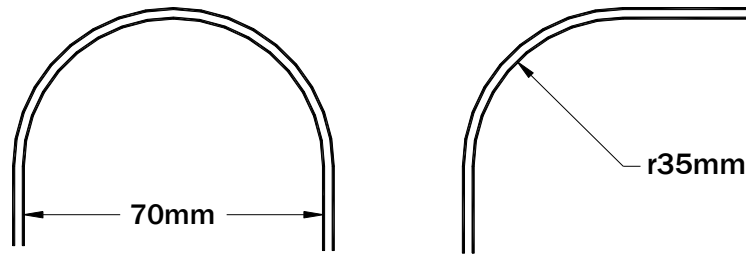

Diagram Not To Scale

Figure 64. Minimum Bend Radius Of Fiber Optic Cable

### 6.3.6 Conduit

Conduit can be used to route harnesses from the BDS components to the battery rack and to a wire tray to distribute the wires to each cell.

### 6.3.7 Panduit

A Panduit (or equivalent) slotted cable tray with cover is normally used to distribute wires to the cells. Suggested slotted cable trays and covers are Panduit E1X1L66 with C1L66, or E5X5L66 with C5L66.

## 7 Begin System Installation

The following steps are required for system installation.

### 7.1 Identify & Verify Cells, Markings, Load Steps, Configuration, etc.

1. Identify cell 1.
2. Identify and verify that all cells are marked correctly. Mark if necessary.
3. Verify wire routing, per drawing if provided; (conduit, panduit etc.)

#### WARNING:

**Never route the wires in the same conduit with other wires in the facility. Never run the wires parallel to the battery bus. Some inverters emit large signal spikes that could cause induction problems through the connection cables.**

4. Identify load step connections.
5. Double-check the configuration by referring to the drawings provided with the system.

#### WARNING:

**Check the configuration before installation. If the wrong configuration is installed onto the battery, the unit could be permanently damaged.**



## 7.2 Fit Tab Washers

Fit tab washers per drawings provided with the system and manual. Remember to place extra tab washers for load steps and intertiers if applicable. Refer to Installation Details drawing BDS-123-A380 for more detailed connection information.

### 7.3 Voltage Sense Lead Connection Preparation

**WARNING:**

Before making any connections to the battery, verify the fuses have been removed from the fuse holders. Do not install the fuses until the time that the entire system is commissioned.

In hazardous voltage applications where battery voltage is greater than 60VDC, remove the load cable fuse before disconnecting the load cable connector from the Resistance Test Module.

**NOTE:**

Each wire must have a 10K $\Omega$  flameproof resistor with the same construction as the voltage sense lead.

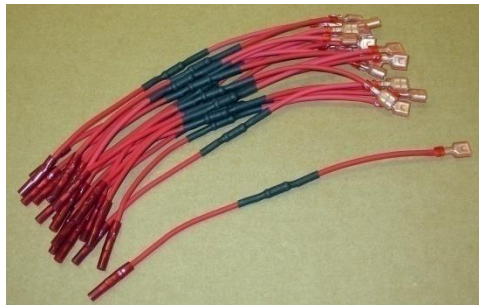

Figure 65. BDS Flex Resist W/Butt Splice–10K $\Omega$  Flameproof

After determining the required wire length to the connection point, begin assembling the 10K resistor to the sense leads by stripping the wire first, approximately  $\frac{1}{4}$ ".

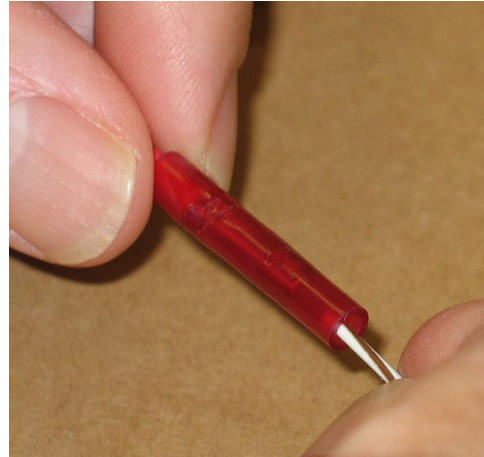

Figure 66. Strip Sense Lead Wire

**NOTE:**

We have chosen a white/brown/orange wire here for demonstration purposes.

Next, place the stripped wire into the 10K resistor assembly.



**Figure 67. Insert Sense Lead Wire Into 10K Resistor Assembly**

Place the sense lead and insulated section of the 10K resistor into the first die of the Panduit crimper, making sure that the intersection is centered within the die.

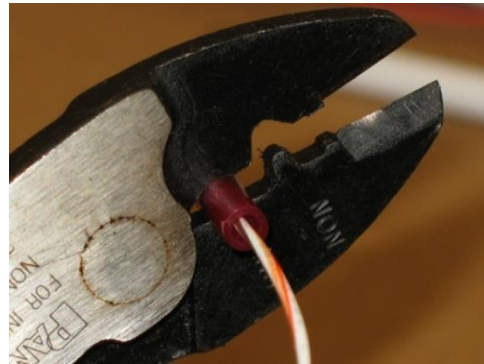

**Figure 68. Crimping With Panduit Crimper**

Now, crimp the connection.

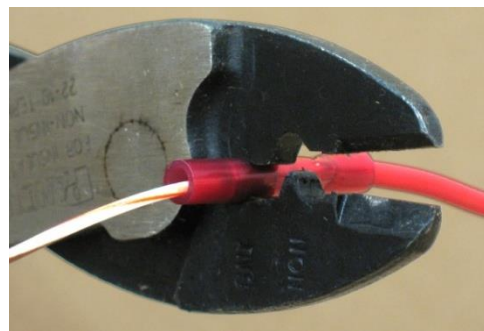

**Figure 69. Crimping 10k Resistor Assembly To Sense Lead**

Check the crimped connection to make sure it holds well.



**Figure 70. Checking 10K Resistor And Sense Lead Connection**

Place sense lead and resistor close to its final destination to be connected later.



**CAUTION:**

*When a load lead wire connects to the same point as a voltage sense lead, the load lead wire must be the closest to the cell's post. See drawing BDS–123–A380 ID Full Washer Quick Connect Sense/Load Leads.*

## 7.4 Step By Step Instructions

Re-check the configuration.

Build each load lead wire using BDS–193–A453 Fuse Protected Load Lead, observing length restrictions. A snapshot of the drawing is located here for convenience. All Drawings are located in the rear of the manual.

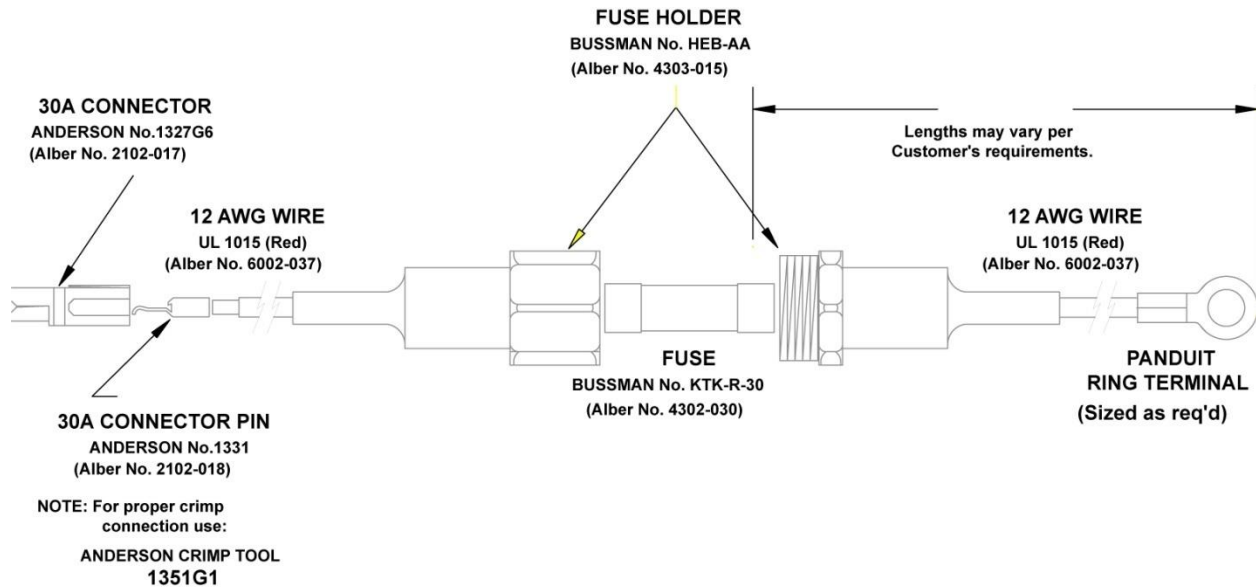

**Figure 71. BDS–193–A453 Fuse Protected Load Lead (snapshot)**

Choose the desired length of load lead wire.

Strip one end of the 12 AWG load lead wire to  $\frac{5}{16}$ ".

For ease of future cell maintenance, leave some slack in the wiring to the cells.



**Figure 72. Strip 12 AWG Load Lead Wire**

Position the contact into the #30 die.

Center the crimp portion of the contact in the die with the rounded portion of the die up and against the seam on the contact and the tongue of the die directly opposite.

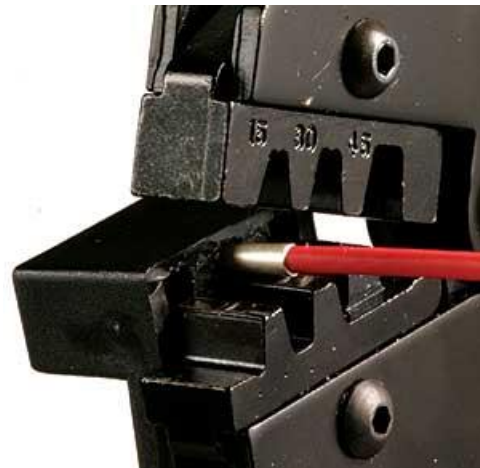

**Figure 73. #30 Die With Andersen Contact/Pin**

Place the wire inside of the contact pin.

Before crimping the contacts onto the load lead wire, orient the contacts so that the contacts are all facing the correct direction, that is, so they go into the Andersen 30 amp connector/housings without twisting the wire. Notice that the contacts go into the housings one way only.

Double check that the wire is fully inserted into the contact and crimp down firmly.



**Figure 74. Inserting Load Lead Wire Into Pin To Crimp**

Crimp with almost but not quite full force without bottoming out the tool.

Don't spread the connector apart.

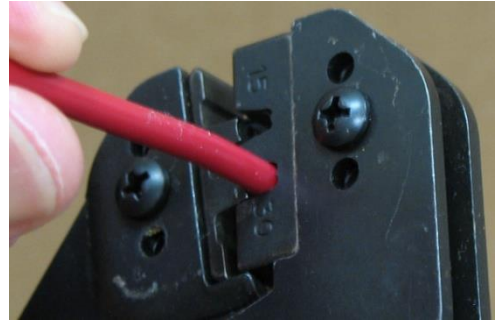

**Figure 75. Crimping Load Lead Wire To Pin**

A good connection is where the dimensions of the crimped portion are no more than an un-crimped pin. If the crimp is flattened then the pin will not readily push into the housing. Rotate the crimp 90 degrees and squeeze it again in the number three die but this time not as firmly. The idea is to make the width of the crimp just slightly less than it was prior to crimping.



**Figure 76. Good Crimp**

Assemble the black plastic Andersen connectors/housings together. Put the connector housings together before inserting the connector pins. The plastic housings are held together with dovetail joints. Always slide these joints together! Notice that they slide together in one direction only.

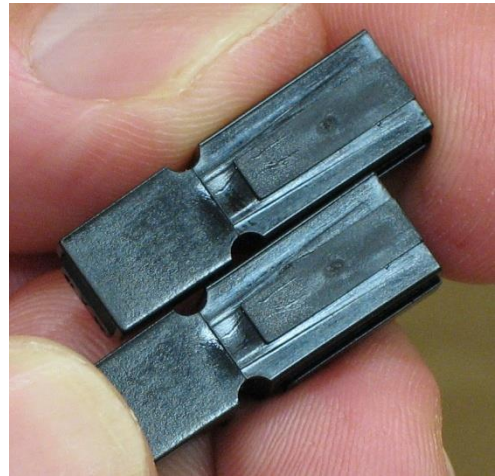

**Figure 77. Andersen Connectors Together**



**WARNING:**

**Always slide the Andersen connectors together and notice that they slide together in one direction only. Do not snap the housings together or apart as damage may occur.**

Insert the contacts with their sharp edge down against the flat spring within the housing. The contacts should slide in and click.

If an audible click is not heard then they are not fully seated, the contacts need to be seated/fixed. When inserted fully the contact and its wire "float" slightly inside its housing. If it feels tight it may not be snapped in fully or the contact is wider than it originally was during crimping.

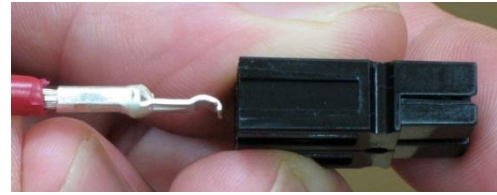
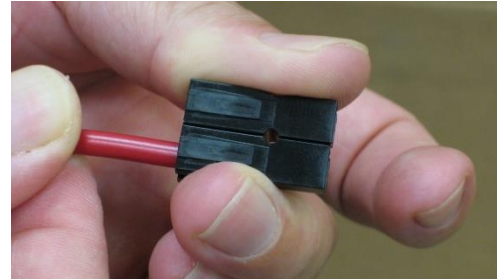

**Figure 78. Insert Andersen Contact Into Andersen Connector**

Tug slightly on the assembled connector to make sure the contacts are locked in place.

If there is trouble locking the contact into the housing, then look at the side profile of the contacts.

It is possible that it may need to be adjusted and/or straightened before inserting it into the housing.



**Figure 79. Tug On Assembled Connector**

**NOTE:**

*"Measure twice, cut once." The load delivered during a resistance test may be degraded if the load lead wire is too long. Therefore, when building the load lead wires, maintain an overall length from 22 to 90 feet round trip. Round trip consists of, for example, a connection from Load Connection 1, out to the battery, and back from the battery to Load Connection 2. If connection length is not maintained, the load will be too low or high, and resistance test results may be affected.*

Strip the other end of the inline fuseholder assembly to  $\frac{5}{16}$ ".



**Figure 80. Strip 12 AWG Load Lead Wire**



**ALWAYS MAKE SURE the polarity is correct before plugging in the equipment. Do not plug in the equipment before checking that all load lead wires have been measured, cut and crimped according to system drawings.**

Choose die C (12 to 10) on the Thomas and Betts crimper.



**Figure 81. Thomas And Betts Crimper**

Place about 1.5 inches of  $\frac{3}{8}$ " heat shrink tubing onto the load lead wire.

Now, secure the open end of the fuseholder on the inline fuseholder assembly into die C.

Then place the load lead wire into the secured inline fuseholder assembly, and crimp.

Turn 90° and crimp again.

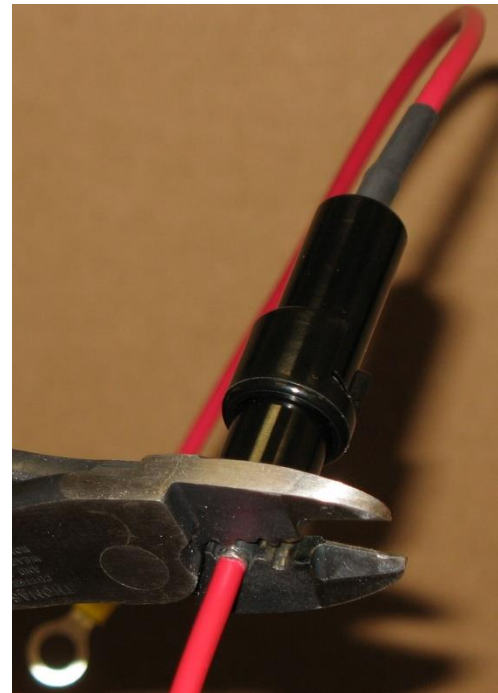

**Figure 82. Crimp Fuseholder Onto Inline Fuseholder Assembly**

Tug on the connection to make sure the connection will hold well.



**Figure 83. Checking Fuseholder/Load**



## Lead Wire Connection

---

Pull the heat shrink tubing up to cover the wire and the fuseholder connection.

Use a heat source to shrink.

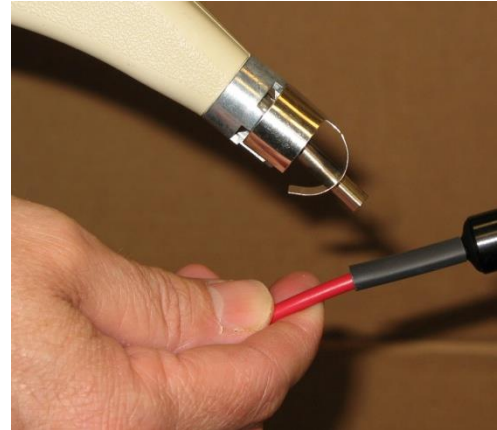

**Figure 84. Securing Fuseholder Load Lead Wire Connection With Heat Shrink**

---

 **CAUTION:**

*Never wrap excess load lead wire into a coil. A tight coil will result in induction that can adversely affect equipment operation. Leave excess cable in loose, flat lengths.*

---

 **WARNING:**

**Before making any connections to the battery, verify the fuses have been removed from the fuse holders. Do not install the fuses until the time that the entire system is commissioned.**

**In hazardous voltage applications (where battery voltage is greater than 60VDC, remove the load lead wire fuse before disconnecting the load lead wire connector from the BDS.**

## 7.5 Sense Lead Harness Routing from DCMs to the Battery

The installer normally determines the wire routing. Do not route BDS system wires in the same conduit as other wires in the facility. Usually, use a Panduit (or equivalent) slotted cable tray with cover to distribute wires to the cells. Suggested slotted cable trays and covers are Panduit E1X1L66 with C1L66, or E5X5L66 with C5L66.

## 7.6 Cell Voltage Sense Lead Connections

Voltage sense leads connect from each DCM to the individual cells. Cut each sense lead to the appropriate length and assemble it using the flex resistor lead assembly and its drawing BDS-1251-A640.

The sense lead resistor assemblies include a 10K 2W 1% flameproof resistor that reduces the risk of a short circuit during installation and maintenance.

**NOTE:**

*For overall sense lead connections, please refer to the wiring schematic that accompanied the system.*

The DCM to Battery Connections drawing in your drawing package has a schematic of these connections.

Properly label each sense lead to simplify the connection process.

When connecting a sense lead to the same battery terminal as the load cable, the load cable must be closest to the cell post. Refer to your copy of BDS-123-A380.

**NOTE:**

*The last sense lead on a DCM connects to the same point as the first sense lead of the next DCM within a battery string. Refer to the DCM to Battery Connections drawing.*

*Drawings in this manual are for reference only. Use the drawings supplied with your system.*

## 7.7 Intertier Connections

Most battery installations have cables connecting groups of cells on different levels (tiers) within a battery string. Since intertier cables normally have higher resistance than intercell connections, additional sense leads are used to monitor the resistance of these cables. Up to five intertier channels per DCM are provided. The software accommodates up to 15 intertier connections per battery.



**CAUTION:**

*The sense leads monitoring an intertier connection must be from the DCM measuring the cell that has its negative post connected to the beginning of the intertier cable.*

## 7.8 Internal Resistance Test Current Cable Connections

Resistance test current cables connect from the Resistance Test Modules to certain cells in the battery string. Cable is supplied based on an average of 35 feet per lead, unless a special length is ordered. Cut the cables to the proper length before termination.

Connect the first resistance test current cable to the positive post of the first cell. The last lead connects to the negative post of the last cell. Other connections depend on the battery configuration.

Refer to the DCM to Battery Connections drawing for a connection diagram. Again, verify fuses are removed from fuse holders before making any battery connections. Refer to your drawings for resistance test current cable construction details. Label each cable at the Resistance Test Module to facilitate servicing.

## 7.9 Overall Voltage Sense Leads

Connect the Overall Voltage OV sense leads to DCM–1. The OV leads run from the Overall Voltage connector to the most positive and most negative posts of the battery string. Be sure to install 10K 2W 1% flameproof resistors at the battery connection points.



### **WARNING:**

**Install DCMs so that each DCM connects to the cells to which it is assigned. Each DCM nameplate indicates the battery string number (for multiple string installations) and the position of the DCM within that string.**



### **CAUTION:**

*Do not wrap excess load cable into a coil. A tight coil will result in induction that can adversely affect equipment operation. Leave excess cable in loose, flat lengths.*

## 7.10 Resistance Test Module Control Cable Connections

The Resistance Test Module RTM for each string is controlled by the DCMs assigned to monitor that string. Connect the DCMs and the RTM using the supplied, 15–conductor cable. Connect the cable from the DCM Load Control connectors to the RTM rear panel connectors, starting with connector DCM–1.

## 7.11 Discharge Current Sensor (Optional)

The BDS–256XL can be used with a magnetic current transducer to measure discharge current. When using a magnetic transducer with 4–conductor shielded cable, connect the Current Transducer connector to the first DCM in the battery string. Refer to BDS–1279–B1205.

## 7.12 Temperature Sensor (Optional)

Two types of BDS temperature probes are available. One probe hangs free for ambient temperature measurement or mounts on a cell post surface. The other, a Teflon coated probe, may be immersed in a flooded cell.

Using 4-conductor shielded cable, wire the sensors to the DCM connector marked Temperature 1 and 2. Up to ten temperature probes may be used per battery string, and up to two temperature probes may be connected to any DCM associated with that string.

### 7.13 Float Current Sensor (Optional)

There is one float current sensor channel available. Connect to the DCM rear panel Float Current connector on the first DCM in the battery string. Refer to your copy of BDS–1283–A659 and the Float Charging Current Probe User's Manual for termination details.

We are choosing the Multitel Kit for this manual. Similarities may exist in other float current kits. Multitel's directions are included in this section for convenience.

The following photos are here TO HELP. Please see the FCCP user's guide delivered with the system for possible updates and individual nuances. .

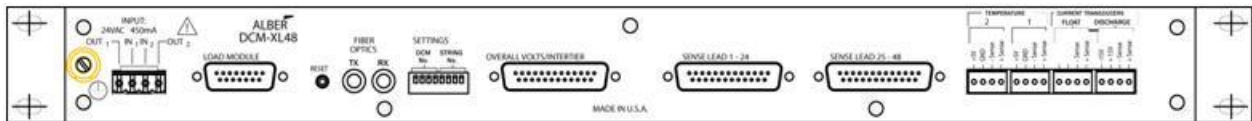

Figure 85. DCM-XL48 Rear Panel Photo From Drawing BDS-1279-B1204



Figure 86. Multitel FCCP pn 5610-051



Figure 87. Float Cable



Figure 88. Multitel FCCP Rear Panel

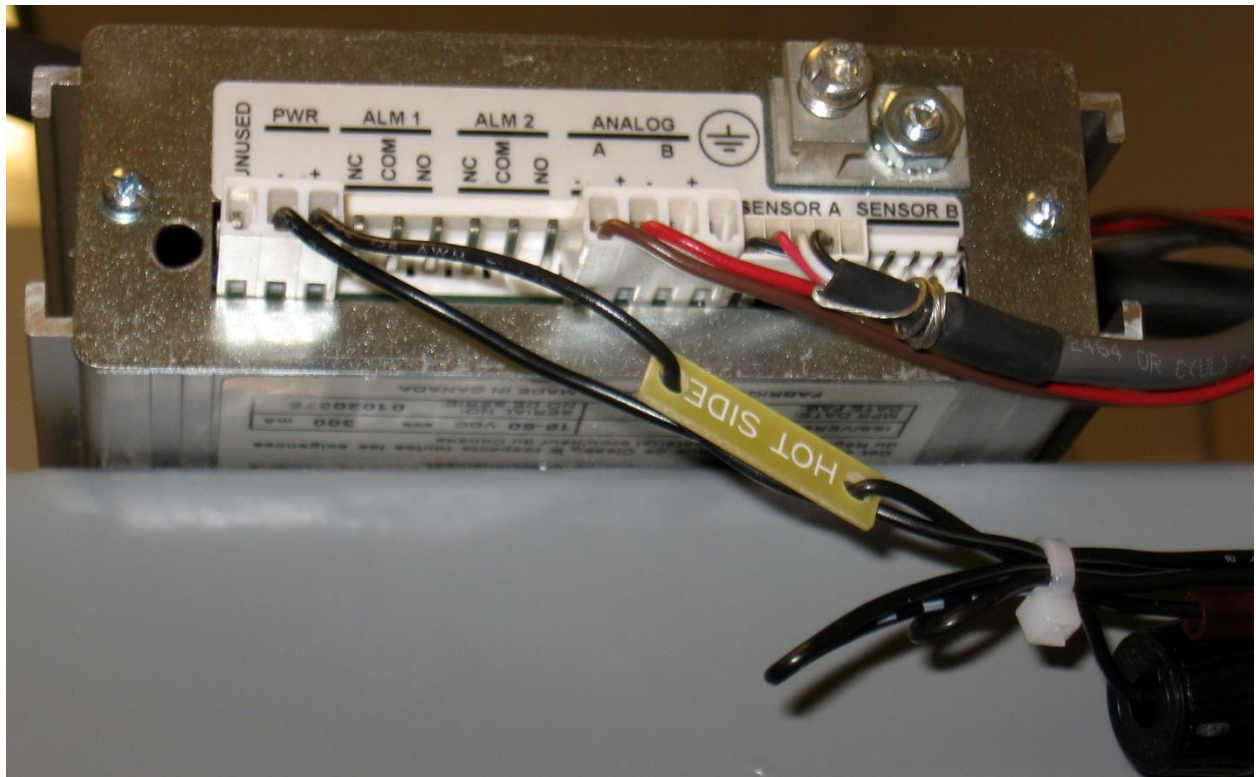

Figure 89. FCCP Connections FCCP

Figure 5 – Routing the cable

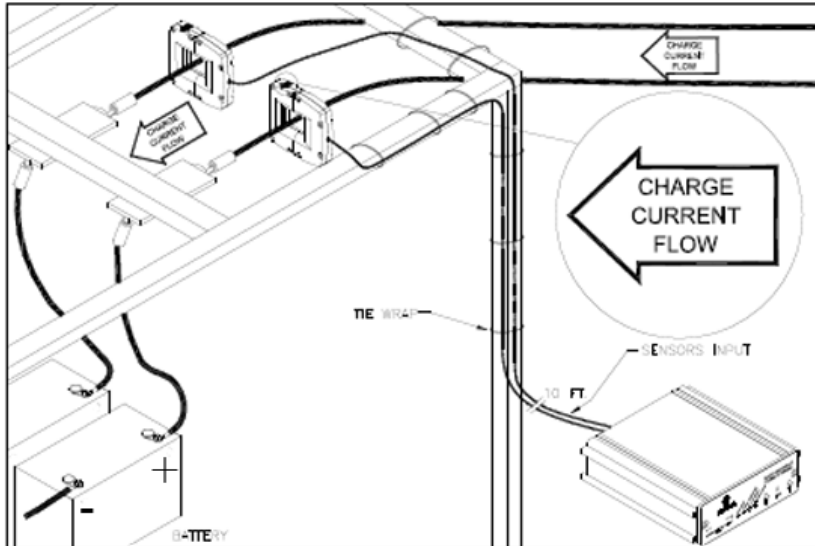

Figure 90. Multitel's FCCP—Routing The Cable



Figure 91. Multitel's FCCP with Power Source And Inline Fuseholder

**NOTE:**

For best results follow the manufacturer's instructions, and please refer to BDS-1283-A659 for FCCP assembly. Part number 4000-026 is to be used for power with the assembly of the FCCP.

Part number 5610-050 is for dual strings and would include one more clamp on the probe.

\*\*The Kit that includes the FCCP, float cable/CT harness and power supply is available: KIT-1101-185. 4000-026 and 1101-185-xx Float CT Cable are included in the kit.



Figure 92. Float Current Sensor

Please refer to BDS-1283-A659 for FCCP assembly for termination details and to section 6.3 of Multitel's *Float Charging Current Probe Installation Manual*, displayed here for convenience.

**6.3 WIRING A POWER CABLE TO THE FCCP**

1. Locate the voltage source to power the FCCP control unit. Using a DVM, verify that the voltage difference between the polarities is between 18 and 60 volts DC.
2. Using shielded cable, route from the control unit's mounting location to the located and verified voltage source. If access to the rear of the control unit is restricted, be sure to leave enough cable length to attach the power connector to the rear of the control unit and then to slide the complete assembly into its final installation position. Leave enough cable length to allow connection to the power source.
3. Permanently secure the cable run with cable ties.
4. Install inline fuse holders to the power source end of the shielded cable. The fuses should be as close to the power source as possible. Leave the fuses out of the fuse holder temporarily. Place the fuses somewhere safe where they can be found later.
5. Permanently connect the power source cable to the power source, paying close attention to polarity. Be sure to connect the cable ground to a reliable system ground connection, close to the utilized power source.
6. Turn your attention to the control unit end of the cable. Strip only enough insulation and shield from the cable as necessary to crimp the connector pins and install the connector housing.

---

**NOTE:** To maintain the expected FCC emissions, the cable shield needs to come to the base of the connector housing. Therefore, it is critical to only strip away as much insulation as needed to install the connector pins and housing.

---

**FLOAT CHARGING CURRENT PROBE****INSTALLATION**

7. Using the tool, permanently crimp the pins to the wires exposed at the end of the shielded cable to go to the control unit. Slide the crimped wires into the connector housing, making sure to observe the correct polarity and to leave the ground conductor free.
8. Return to the fuse holders and install the fuses temporarily removed earlier.
9. Plug the connector housing into the control unit and verify that the unit becomes active. Remove the connector from the control unit and continue the installation.

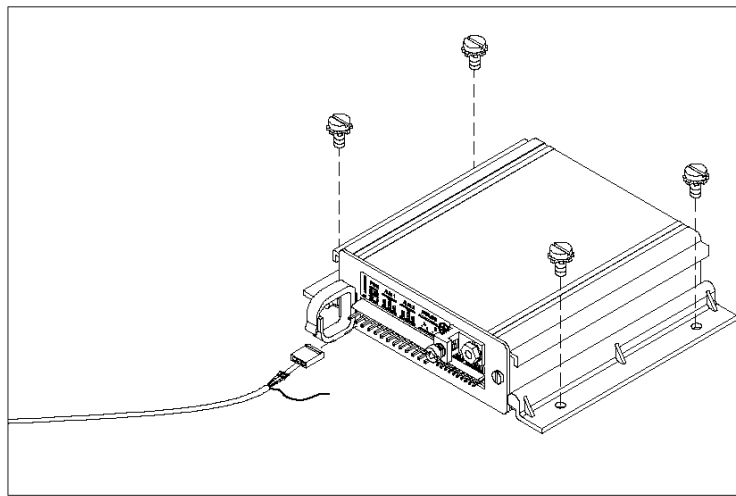

***Figure 8 – Inserting the Power Connector***

**Figure 94. Section 6.3 Of Multitel's FCCP Installation Manual Pg. 39**



## 7.14 Conduit

Optionally, pass conduit through the lower left hole and mount an outlet box inside the cabinet. This must be done by a qualified electrician and meet NEC requirements. Install the remaining components as follows. Please refer to drawing BDS–1278–B1203. If

1. If using an optional UPS, install it near the bottom of the rack.
2. Install the computer monitor on the cabinet top shelf.  
Connect the power cord to the power strip.
3. Install the computer/PC on the shelf below the video display.  
Connect the power cord to the power strip.
4. Connect the monitor to the computer.
5. Install the keyboard in the keyboard drawer and connect it to the computer.
6. If mounting the Controller in the 19" rack, install it below the computer.  
Connect an RS–232C cable from the Controller to a COM port on the computer.  
Plug the power cord into the power strip.
7. using a modem to dial out, connect the phone line to the RJ–11 jack on the Controller rear panel.  
Use a minimum 26AWG TELCO line cord. Please refer to section 5.2 Modem on page 66 for more information on communication connections.
8. If connecting to a LAN, connect the customer–supplied network cable to the RJ–45 connector on the Controller rear panel. Please refer to section 5.5 RJ–45 on page 68 for more information on communication connections.



### **CAUTION:**

---

*Installing the fiber optic and 24 volt power cables from the Controller to the DCMs is the last step. **Do not do this until the DCMs have been physically mounted in place.***

---

## 7.15 System with No Local Computer

If not using a local computer and cabinet, install the Controller as follows.

1. Provide UPS–protected AC power to the location where each Controller will be installed.
2. Unpack the Controller and, if mounting it in a 19" rack or tower enclosure, install it.  
Connect the AC power cord to the UPS protected outlet.
3. If using a modem to dial out, connect the phone line to the RJ–11 jack on the Controller rear panel.  
Use a minimum 26AWG TELCO line cord. Please refer to section 5.2 Modem on page 66 for more information on communication connections.
4. If connecting to a LAN, connect the customer–supplied network cable to the RJ–45 connector on the Controller rear panel. Please refer to section 5.5 RJ–45 on page 68 for more information on communication connections.



### **CAUTION:**

---

*Installing the fiber optic and 24 volt power cables from the Controller to the DCMs is the last step. **Do not do this until the DCMs have been physically mounted in place.***

---

## 7.16 System with Local Computer

If using a computer and cabinet, place the cabinet where it will be permanently mounted. If using fiber optic cable, locate the cabinet so the fiber optic cable run does not exceed 250 feet (76 meters) from the Controller to the DCM. Keep the back of the cabinet accessible. Securely anchor the four corners of the cabinet to the floor.

Fill the container at the bottom of the cabinet with ballast. This provides stability to help prevent the cabinet from tipping over. The recommended ballast is all-purpose sand (Sure-Mix® All Purpose Sand or equivalent) available at most home improvement stores.

**WARNING:**

**Do not energize the cabinet or any component with battery voltage until after the installation is complete.**

Look at the system drawing and the physical facility and determine how the fiber optic and power cables to the DCMs must exit the cabinet. Two 1½" holes for wire passage are on the left side of the cabinet. Pass the AC power cord for the power strip mounted inside the cabinet through the lower left hole and plug it into a UPS-protected outlet after installation is complete. The electrical service required is less than 15A at 115VAC or 7.5A at 230VAC. If using an internally mounted Uninterruptible Power Supply UPS, plug the power strip AC cord into the UPS, pass the UPS power cord through the hole, and plug it into an AC outlet after installation is complete.

Optionally, pass conduit through the lower left hole and mount an outlet box inside the cabinet. This must be done by a qualified electrician and meet NEC requirements.

Install the remaining components as follows. Refer to your copy of BDS-1278-B1203.

1. If using an optional UPS, install it near the bottom of the rack.
2. Install the computer monitor on the cabinet top shelf. Connect the power cord to the power strip.
3. Install the computer/PC on the shelf below the video display. Connect the power cord to the power strip.
4. Connect the monitor to the computer.
5. Install the keyboard in the keyboard drawer and connect it to the computer.
6. If mounting the Controller in the 19" rack, install it below the computer. Connect an RS-232C cable from the Controller to a COM port on the computer. Plug the power cord into the power strip.
7. If using a modem to dial out, connect the phone line to the RJ-11 jack on the Controller rear panel. Use a minimum 26AWG TELCO line cord.
8. If connecting to a LAN, connect the customer-supplied network cable to the RJ-45 connector on the Controller rear panel.

**CAUTION:**

*Installing the fiber optic and 24 volt power cables from the Controller to the DCMs is the last step. **Do not do this until the DCMs have been physically mounted in place.***

### 7.17 Alarm Contacts and Remote Alarm Reset

There are two sets of Form C alarm contacts, labeled Critical and Maintenance, on the Controller rear panel. Each set of connections has a Common COM, Normally Closed NC, and Normally Open NO terminal.

**NOTE:**

*These alarms are BMDM program configurable under Setup on the Main Menu.*

Connection can be made directly to a facility's alarm reporting system. If there is more than one BDS at the same location and only one set of contacts can be monitored, the alarm contacts can be wired in parallel.

The plus and minus remote reset input contacts are on the rear panel of the Controller. Connecting a +12VDC signal to the reset input contacts will reset alarms for all strings.

## 8 Final Steps Connecting To Battery Terminals

The load lead wire connection and sense lead connection appear in a snapshot here for convenience.

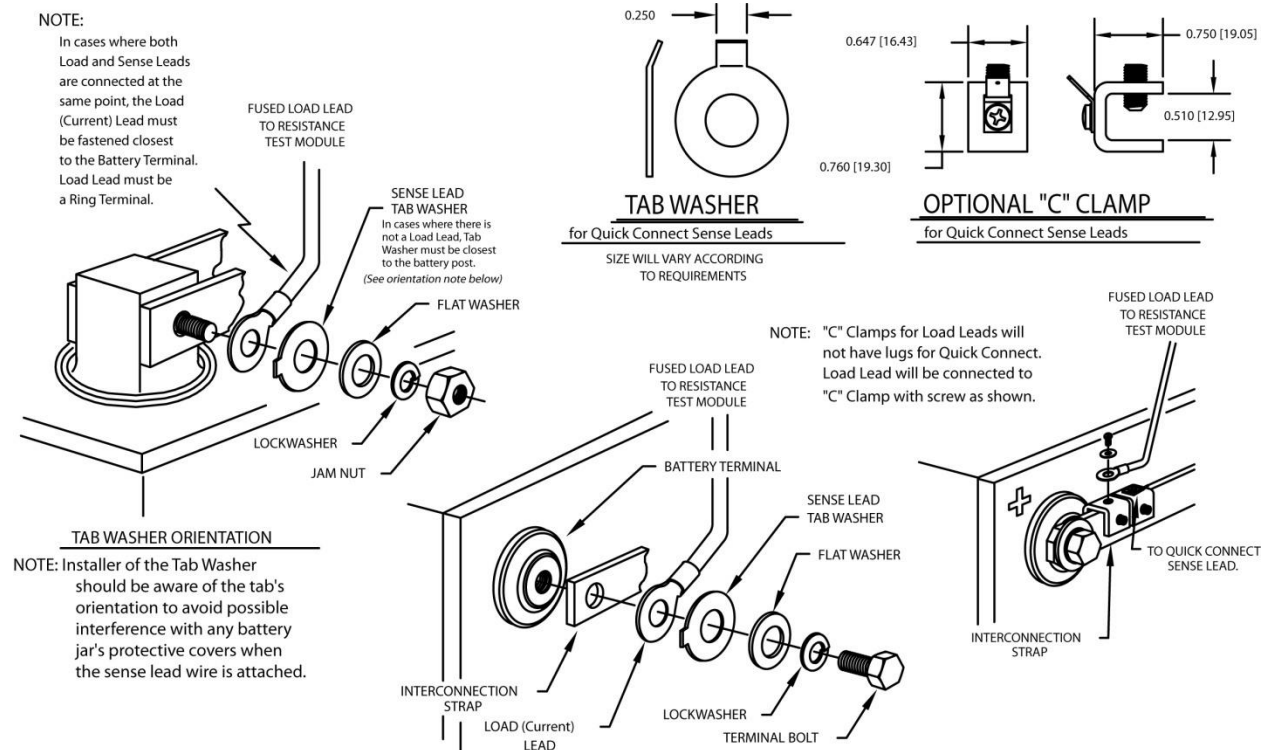

**Figure 95. BDS-123-A380 ID Full Washer Quick Connect Sense/Load Leads (snapshot)**

Connect the load lead wires to positive posts, except for the last cell, where the connection is to the negative post.

## 9 Final Steps Communication Connections

### 9.1 Communication Connections

Connection to the BDS can be via:

1. a modem,
2. the USB (front panel CM–XL8)
3. RJ–45 or RS–232 (rear panel CM–XL8).

All methods allow battery parameters to be checked.

### 9.2 Modem

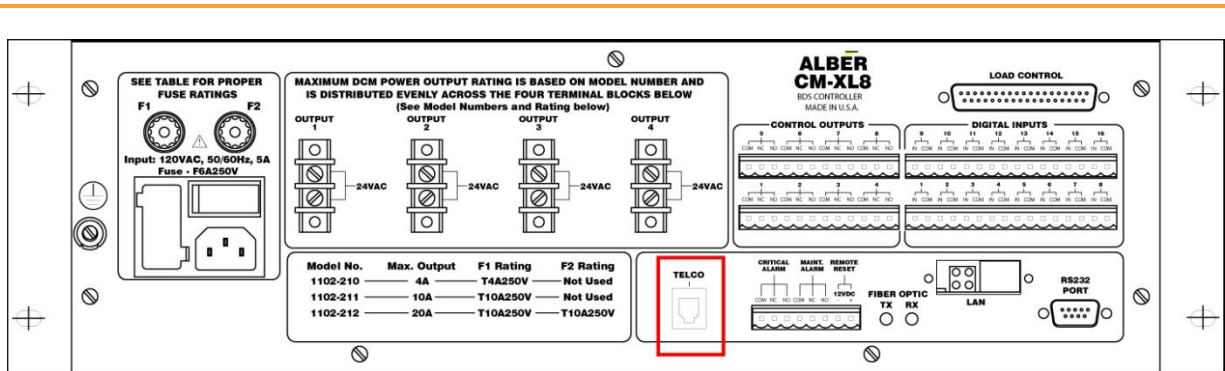

Figure 96. Modem Connection On The Rear Of CM–XL8

The BDS can connect to a telephone line using the TELCO RJ–11 connector on the CM–XL8 rear panel. To communicate with a BDS from a remote location, connect the BDS rear panel modem connector to a telephone line. Connect the remote computer’s modem to the telephone line according to the computer manufacturer's instructions.

When connecting via modem, use 26AWG (minimum) TELCO line cord. Pins 2 and 3 of the RJ–11 TELCO connector are for the tip and ring connection.



Figure 97. TELCO RJ–11 Modem Connection

### 9.3 USB

Use the front panel USB port for connecting a portable computer for service or data analysis.



Figure 98. USB Cable



Figure 99. Laptop

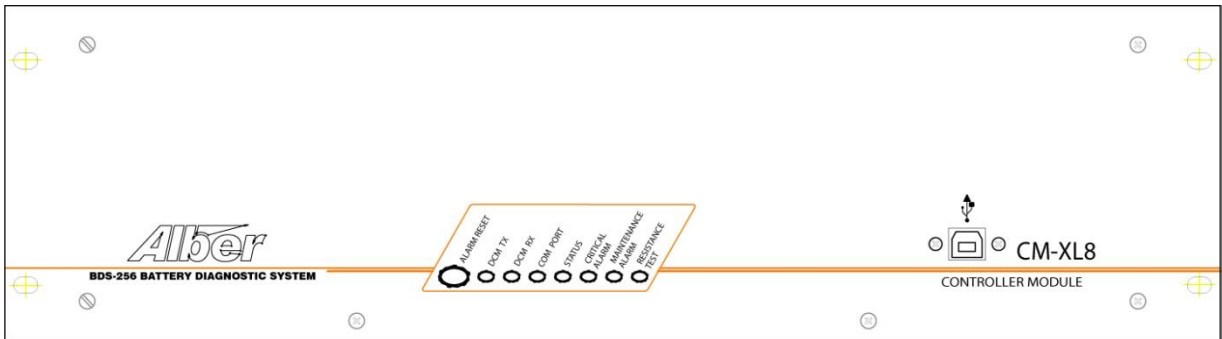

Figure 100. USB Connection CM-XL8 Front Panel

### 9.4 RS-232

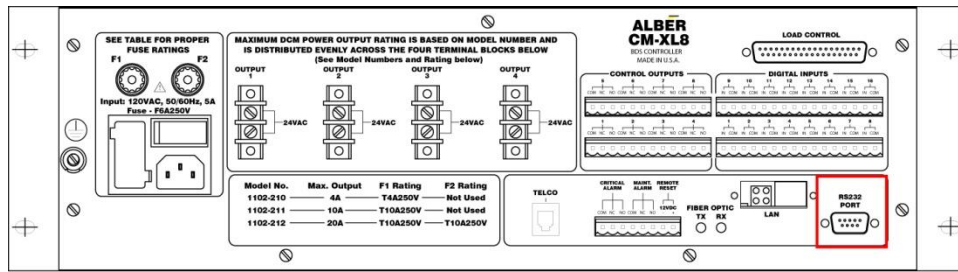

Figure 101. RS-232 Local Port Rear Panel CM-XL8

Use the 9-pin RS-232 Local port on the rear panel of the Controller for connecting to a permanent Local computer or a building management system.

For a permanently connected computer, connect a 9-pin female to female cable (pin to pin construction) to the CM-XL8 rear panel port available and to an available port on the computer to be used.

The connection between the BDS and the computer must not exceed 25 feet.

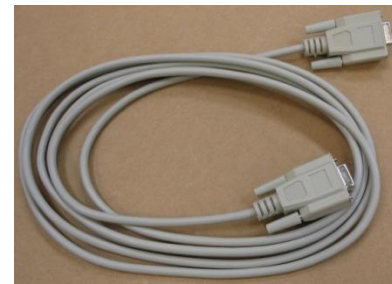

Figure 102. RS-232 9 Pin Female to Female Cable

### 9.5 RJ-45

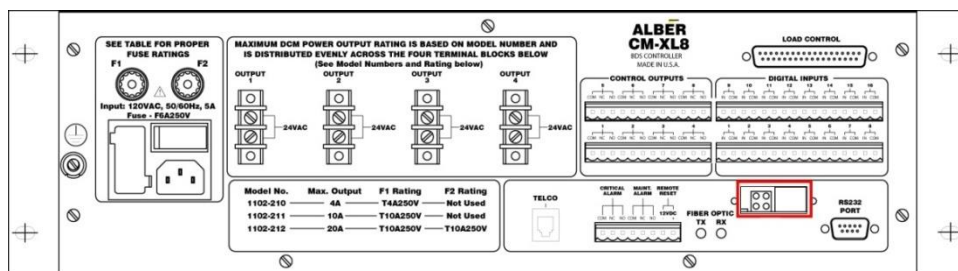

Figure 103. RJ-45 Connection Rear Panel CM-XL8

If the network option is installed, there is an RJ-45 connector installed on the rear panel of the Controller.

Connect an Ethernet patch cable between the controller and the network to be utilized.



Figure 104. RJ-45

## 10 Drawings

# Index

¼ inch heat shrink tubing	
pn 2880–004.....	17
¼ inch tab washer	
pn 2120–028.....	16
10 gauge <sup>5</sup> / <sub>16</sub> inch insulated ring term UL	
pn 2800–109.....	14
115VAC 50/60Hz.....	27
12 gauge UL1015 red	
pn 6002–037.....	16
2 cond 16 Ga black zip cord	
pn 6002–080.....	12
230VAC 50/60Hz.....	27
24VAC power.....	44
30 amp cartridge fuse	
pn 4302–030.....	16
30 amp connector block–UL	
pn 2102–017.....	15
30 amp contact	
pn 2102–018.....	15
4 PQS pluggable terminal	
pn 2140–022.....	13
7 ft telephone cable–UL	
pn 6003–010.....	14
8 PQS pluggable terminal	
pn 2140–024.....	13
AC power receptacle.....	39
alarm.....	8
critical.....	29
maintenance.....	29
remote.....	29
alarm contacts.....	63
ALARM RESET	
switch.....	26
ambient temperature probe	
pn 2900–029.....	20
Andersen connector.....	15, 49, 50
Andersen contact.....	50
Andersen housing.....	15
Anderson crimping tool	
pn 5400–003.....	22
ballast.....	43
BDS flex resist w/butt splice	
pn 1100–437BS.....	14
BDS Flex resist w/butt splice	
pn 1100–437BS.....	14
BDS–256XL.....	9
BMDM software	
pn 2027–001.....	24
building mgt system.....	25
cabinet wiring.....	44, 62
cable	
cable tray.....	54
fiber optic length.....	43
fiber optic radius.....	44
maximum length.....	43
sense leads.....	54
test current.....	54
CAUTION.....	6, 48, 53, 55, 61, 62
cell 1.....	45
check connection/crimp.....	52
configuration.....	40, 45, 48
connector interface	
between harness and cell.....	16
control cables.....	55
control outputs.....	29

crimp.....	49	EMERGENCY	
CRITICAL ALARM .....	29	SHUTDOWN .....	6
detect.....	26	equip	
CT 2000 Amp		safety .....	3
pn 2900-010.....	20	FCCP .....	23
CT cable		FCCP	
pn 1101-184-xx .....	21	pn 5610-051.....	19
current transducer.....	55	FCCP dual strings	
DB9 .....	18	pn 5610-050.....	19
digital input.....	29	features.....	8
dimensions.....	34	female disconnect adapter	
discharge current sensor .....	55	pn 2800-129.....	21
DOUBLE-CHECK		fiber optic .....	See also cable
CONNECTIONS .....	2	transmit .....	26
Drawing		fiber optic amplifiers .....	43
BDS-123-A380 .....	16, 45	fiber optic cable	
BDS-123-A380 .....	40	pn 3703-006.....	12
BDS-1251-A640 .....	22, 40	pn 3703-015.....	12
BDS-1251-A640 .....	14	flameproof resistor .....	54, 55
BDS-1277-B1202 .....	40	float current sensor .....	55
BDS-1278-B1203 .....	61, 62	form C alarm contacts .....	63
BDS-1278-B1203 .....	40	fuse .....	16, 27, 28, 35, 36, 38, 46, 48, 53, 55
BDS-1279-B1204 .....	40, 56	good connection/crimp .....	50
BDS-1282-A658 .....	20, 21	Ground Equip	
BDS-1283-A658 .....	40	Safety.....	3
BDS-1283-A659 .....	19, 21, 40, 56, 58	grounding the equipment.....	38
BDS-1284-A660 .....	40	heat shrink tubing.....	52
BDS-1284-A660 .....	11	High Voltage	
BDS-1285-A661 .....	11, 20, 40	Safety.....	2
BDS-1293-A669 .....	11, 40	indicator	
BDS-163-A424 .....	40	green.....	25
BDS-193-A453 .....	14, 15, 16, 18, 48	red.....	25
BDS-193-A453 .....	40	yellow .....	25
BDS-2411-D1775 .....	40	indicators .....	25
BDS-2420-C958 .....	40	inline fuseholder	
earth ground.....	38	pn 1100-433UL.....	14, 17, 18, 51, 52
electrolyte temp cable.....	11		
pn 1100-186-xx .....	11		
electrolyte temperature probe			
pn 2900-010.....	20		



installation of system	pn 5400-007.....22
with local computer.....42, 62	pn 5400-008.....22
with no local computer.....61	
LAN connection.....61, 62	
Legal Info	Part Number
equip cover.....3	1100-433UL-inline fuseholder assembly.....18
FCC.....1	1100-437BS-flex resist w/butt splice .....14
Fuse.....3	1100-496-DCM control .....13
ground equip.....3	1101-181-xx-sense lead harness .....11
High Voltage .....2	1101-182-xx-DCM OV cable .....11
Regulatory .....1	1101-183-xx-temp sense lead harness.....11
Safety .....2	1101-184-xx-CT cable.....21
safety symbols .....2	1101-185-xx-float CT cable.....21
Service .....1	1101-186-xx-electrolyte temp cable .....11
Telephone.....1	2025-108-USB2 hi speed cable .....15
load control .....29	2025-117-RS-232 serial cable.....18
load lead wire connection .....48	2025-1xx-inkjet printers for PC(s) .....24
load step wire .....16	2027-001-BMDM software .....24
load too high.....51	2102-017-30 amp connector block .....15
load too low.....51	2102-018-30 amp contact.....15
local computer.....42, 62	2102-028-¼ inch tab washer.....16
magnetic transducer.....55	2140-022-4 POS pluggable terminal .....13
maintenance alarm.....29	2140-024-8 POS pluggable terminal .....13
mark cells.....45	2800-005-¼ inch heat shrink tubing.....17
MODBUS.....25	2800-109-10-GA 5/16 inch insulated ring term ..14
Model Number	2800-129-female disconnect adapter.....21
CM-XL8.....9	2900-010-electrolyte temp probe.....20
modem	2900-029-ambient temp probe.....20
TELCO cord 26AWG .....64	3703-006-fiber optic cable .....12
modem connection.....61, 62	3703-015-fiber optic kit .....12
modem TELCO connection cable.....14	4000-026-FCCP power source.....19
Molex crimping tool	4302-030-30 amp cartridge fuse.....16
pn 5400-006.....23	5400-002-Panduit crimping tool .....22
Multitel's FCCP users guide .....58	5400-003-Andersen crimping tool .....22
network connection.....61, 62	5400-006-Molex crimping tool.....23
OV sense leads.....55	5400-007-Panduit crimping tool .....22
OV/IT sense lead harness	5400-008-Panduit crimping tool .....22
pn 1101-182-xx .....11	5610-006-CT.....20
Panduit cable tray.....45	5610-051-FCCP.....19
Panduit crimping tool	5610-051-Multitel FCCP .....19
pn 5400-002.....22	6002-037-12 gauge UL1015 red wire.....16
	6002-080-2 cond 16 Ga black zip cord .....12
	6003-006-Euro power cord .....18
	6003-007-UK power cord .....18
	6003-008-power cord .....18
	6003-010-TELCO/modem connection cable .....14
	KIT-1101-185-FCCP Kit.....19
	PC

pn 2025-05x .....	24	pn 1101-181-xx .....	11
polarity.....	51	sense leads .....	54
port		service	
RS-232 .....	29	access.....	43
power.....	27	specs	
power cord Euro		inputs.....	32, 35
pn 6003-006.....	18	outputs .....	32
power cord UK		status .....	30
pn 6003-007.....	18	system diagram .....	42
power cord US		tab washer .....	16
pn 6003-008.....	18	TELCO.....	29
printer		TELCO cord 26AWG .....	39, 64
pn 2025-1xx .....	24	temp	
remote reset contact .....	63	ventilation.....	5
repeater input/output .....	43	temp sense lead harness	
resistor .....	54, 55	pn 1101-183-xx .....	11
RJ-11 TELCO cord 26AWG .....	64	temperature sensor.....	55
RS-232 local port.....	66	test current cable.....	54
RS-232 serial cable		Thomas and Betts crimper.....	51
pn 2025-117.....	18	transducer .....	55
RX.....	43	TX43	
Safety		UPS	
Before Power .....	2	wiring.....	44, 62
damage .....	3	USB cable	
drawings .....	5	pn 2025-108.....	15
Emergency shutdown .....	6	USB port.....	26
equip cover .....	3	USB2 hi speed cable.....	15
preventive.....	7	ventilation.....	5
service.....	4	temp .....	5
shelving stability .....	4	voltage sense lead connection .....	11
ups .....	6	WARNING .....	1, 2, 3, 6, 7, 21, 27, 42, 45, 55
ventilation.....	5	wire tray.....	See cable tray
sense lead harness			