



Liebert[®] Trinergy[™] Cube

Installation Guide

400 kVA – 1600 kVA, 60 Hz, Three-phase UPS,
Single-module and Multi-module (Distributed Bypass)

The information contained in this document is subject to change without notice and may not be suitable for all applications. While every precaution has been taken to ensure the accuracy and completeness of this document, Vertiv assumes no responsibility and disclaims all liability for damages result from use of this information or for any errors or omissions.

Refer to local regulations and building codes relating to the application, installation, and operation of this product. The consulting engineer, installer, and/or end user is responsible for compliance with all applicable laws and regulations relation to the application, installation, and operation of this product.

The products covered by this instruction manual are manufactured and/or sold by Vertiv. This document is the property of Vertiv and contains confidential and proprietary information owned by Vertiv. Any copying, use, or disclosure of it without the written permission of Vertiv is strictly prohibited.

Names of companies and products are trademarks or registered trademarks of the respective companies. Any questions regarding usage of trademark names should be directed to the original manufacturer.

Technical Support Site

If you encounter any installation or operational issues with your product, check the pertinent section of this manual to see if the issue can be resolved by following outlined procedures.

Visit <https://www.vertiv.com/en-us/support/> for additional assistance.

TABLE OF CONTENTS

1 Important Safety Instructions	1
2 Mechanical Installation	3
2.1 Pre-installation Planning	3
2.2 Preliminary Checks	3
2.3 Environmental Considerations	4
2.3.1 UPS Room	4
2.3.2 Storing the UPS and Batteries for Delayed Installation	5
2.3.3 Installation Altitude	5
2.4 Positioning	6
2.4.1 Moving the Cabinets	6
2.4.2 Clearances	9
2.4.3 Raised-floor Installations	9
2.4.4 Kick Plate Installation — Standard	9
2.4.5 UPS Side Panels	9
2.4.6 Floor Anchors — Optional	9
2.4.7 Special Considerations for 1+N Parallel Systems	9
2.4.8 Unpacking and Unloading the Cabinet from the Pallet	10
2.5 System Configuration	11
2.6 Physical Appearance	12
2.7 Power Cable Busbars	14
2.8 Assembly Procedure for I/O Box 2400A with the Cores (Right/Left Side CORE)	14
2.8.1 Power Connections (Core and I/O Box)	17
2.8.2 Connection for Parallel UPS: Distributed Parallel System Cable Connection - XP019A, XP019B	22
3 Connectivity	25
3.1 UPS Signal Wiring Interconnecting the Communication Cables	25
3.2 Customer Signal Wiring	28
4 Electrical Installation	29
4.1 External Protective Devices	29
4.2 Power Cable Requirements	29
4.3 Sizing the Input Breaker that Feeds the UPS	30
4.3.1 Single or Dual Input Feeds	30
4.3.2 Automatic Transfer Switches	30
4.4 Ground Connection Configuration Guidelines	30
4.4.1 Three-wire Input Connections	31
4.4.2 Recommended Grounding Configuration for Battery Systems	34
4.4.3 High-Resistance Ground Systems	34
4.5 Connecting Equipment Ground Cables and Straps	34
4.6 Connecting DC Input Power	34

- 4.7 Control and Communication Cabling 35
 - 4.7.1 Top-entry Low-voltage Conduit and Cable Routing 37
 - 4.7.2 Bottom-Entry Low-Voltage Conduit and Cable Routing 37
 - 4.7.3 Slots for Liebert® IntelliSlot Cards — SLOT2 and SLOT3 38
 - 4.7.4 Slot for Vertiv™ Liebert® LIFE™ Services Products — SLOT1 39
 - 4.7.5 Serial Interface for Liebert® LIFE™ Services Cards (Serial Input/Output) — XP6 39
 - 4.7.6 Connector for REPO (Input and Status) — AP83_TB4 39
 - 4.7.7 Customizable Output Dry Contacts — AP90_XP12, AP83-TB12 40
 - 4.7.8 Customizable Input Dry Contacts — AP90-XP11, AP83-TB11 A 43
 - 4.7.9 Connector for Parallel UPS Connection — AP88-XP019A, AP88-XP019B 45
 - 4.7.10 UPS Control Contacts with Battery Cabinet or Module Battery Disconnect 45
 - 4.7.11 UPS Control Contacts with Global Maintenance Bypass 46
- 4.8 Distributed Static Switch (1+N) System Cabling Layouts 46
- 4.9 Electrical Connections to I/O Box to Cores 48
- 5 Optional Equipment 55**
- 5.1 Factory-Installed Options 55
 - 5.1.1 Single-Input Jumpers 55
 - 5.1.2 Liebert® IntelliSlot Unity-DP Card 55
 - 5.1.3 Liebert® IntelliSlot 485 Card 55
 - 5.1.4 DC Battery Ground Fault Detection 55
 - 5.1.5 Emergency Power Off 55
 - 5.1.6 FCC Compliance Filter Compatibility 55
- 5.2 Field-Installed Options 55
 - 5.2.1 Remote Alarm Status Panel (RAS) 55
 - 5.2.2 Battery Interface Box 55
 - 5.2.3 Temperature Sensor 56
 - 5.2.4 Seismic Anchoring Kit 56
- 5.3 Rectifier Feed Breaker (RFB) 56
- 5.4 Multi-Module System Options and Accessories 56
- 6 Specifications 57**
- Appendices 1**
- Appendix A: Technical Illustrations 1

1 Important Safety Instructions

SAVE THESE INSTRUCTIONS

This manual contains important instructions that should be followed during installation, operation, and maintenance of your Vertiv™ Liebert® Trinergy™ Cube UPS. Read this manual thoroughly, paying special attention to the sections that apply to your installation, before working with the UPS. Retain this manual for use by installing personnel.



WARNING! To Reduce the Risk of Injury, read all instructions.



WARNING! Hazardous Voltage Circuits! Risk of electrical shock. Can cause personal injury or death. This UPS has several circuits that are energized with high DC as well as AC voltages. Check for voltage with both AC and DC voltmeters before working within the UPS. Check for voltage with both AC and DC voltmeters before making contact. Only properly trained and qualified personnel wearing appropriate safety headgear, gloves, shoes and glasses should be involved in installing the equipment or preparing for installation. When performing maintenance on any part of the equipment under power, service personnel and test equipment should be standing on rubber mats. In case of fire involving electrical equipment, use only carbon dioxide fire extinguishers or those approved for use in fighting electrical fires.



WARNING! Risk of heavy unit falling over. Improper handling can cause equipment damage, injury or death. Because the weight distribution in the cabinet is uneven, use extreme care while handling and transporting. Take extreme care when handling UPS cabinets to avoid equipment damage or injury to personnel. Locate the center of gravity symbols and determine the unit weight before handling each cabinet. Test lift and balance the cabinets before transporting. Maintain minimum tilt from vertical at all times. The UPS module weighs up to 9855 lb. (2117 kg).



WARNING! Risk of electrical shock and fire. Can cause equipment damage, personal injury or death. Only normal safety precautions are necessary under typical operation and with all UPS doors closed. The area around the UPS system should be kept free of puddles of water, excess moisture and debris. Only test equipment that is designed for troubleshooting should be used. This is particularly true for oscilloscopes. Always check with an AC and DC voltmeter to ensure safety before making contact with the UPS or using tools to work on any UPS component. Dangerously high potential electric charges may exist at the capacitor banks and at the DC connections even when input power is turned Off. All wiring must be installed by a properly trained and qualified electrician. All power and control wiring must comply with all applicable national, state and local codes. One person should never work alone, even if all power is disconnected from the equipment. A second person should be standing-by to assist and to summon help in case of an accident.

NOTE: This unit complies with the limits for a Class A digital device, pursuant to Part 15 Subpart J of FCC rules. These limits provide reasonable protection against harmful interference in a commercial environment. This unit generates uses and radiates radio frequency energy and, if not installed and used in accordance with this instruction manual, may cause harmful interference to radio communications. Operation of this unit in a residential area may cause harmful interference that the user must correct at his own expense.

NOTE: Materials sold hereunder cannot be used in the patient vicinity (e.g., use where UL, cUL or IEC 60601-1 is required). Medical applications such as invasive procedures and electrical life support equipment are subject to additional terms and conditions. For installation only where accessible to Qualified Persons per NEC 110.27(A)(1) and CEC 2-202(1)(a). In the event of an emergency or problems with the system, please call Liebert Services at 1-800-543-2378. Vertiv: 975 Pittsburgh Drive, Delaware, OH 43015.

2 Mechanical Installation

2.1 Pre-installation Planning

This section describes the requirements that must be taken into account when planning the positioning and cabling of the UPS and related equipment.

Installing personnel should observe these general procedures and practices. The particular conditions of each site will determine the applicability of such procedures.

Due to the large physical size of the Trinergy Cube I/O box/Core Disconnect section, it should be verified that adequate clearances of doorways, walls, and around corners are available throughout the travel route between the point of arrival and the unit's final position. The I/O box and Core Disconnect cabinets are shipped as a single assembly on a single pallet. They are NOT disassembled on site after delivery. See "Physical Characteristics" in the **Table 6.1** on page 57 section of this manual to determine the total size of the I/O Box/Core Disconnect for your specific order. Note: The shipping pallet is the same size regardless the number of Core Disconnects ordered.

Installing personnel must allow room for inspection of the rear section of the I/O Box and Core Disconnect assembly prior to installation. The Vertiv service team will complete the cable connections between the Core Disconnects, Cores, and the three control routes (HUB, Bypass Volts, Parallel).

Pre-Site Visit / Site Readiness Checklist - Installing Contractor (CS-550002-00, R1 08/20) provides further guidance to the installation team for a successful Trinergy Cube installation.



WARNING! Risk of electrical shock. Can cause injury or death. Special care must be taken when working with the batteries associated with this equipment. When the batteries are connected together, the battery terminal voltage will exceed 400VDC and is potentially lethal.

NOTE: All equipment not referred to in this manual is shipped with details of its own mechanical and electrical installation.

NOTE: Risk of incorrect input power connection. Can cause equipment damage. The standard Liebert® UPS is suitable for connection to 60-Hz, 3-phase, 3-wire-plus-ground input power.

NOTE: Do not apply electrical power to the UPS equipment before the arrival of the commissioning engineer. Connecting power before the commissioning engineer determines that the system is properly installed may void the warranty.

2.2 Preliminary Checks

Before installing the equipment, carry out the following preliminary checks:

- Visually examine the equipment for transit damage, both internally and externally. Report any damage to the shipper and to your Vertiv representative immediately.
- Verify that the correct equipment is being installed. The equipment supplied has an identification tag on the interior doors stating the type, size, and main-calibration parameters of the UPS.
- Verify that the room in which the equipment will be installed satisfies the environmental conditions stipulated in the equipment specification, paying particular attention to the ambient temperature and air-exchange system.
- Ensure there is room around the rear of the unit to allow for inspection of the I/O Box and Core Disconnect assembly.

- Verify the surface area where the UPS is to be installed is level to ensure there are no gaps between the Core Disconnect cabinets to Core frames and Core to Core Cabinet frames upon installation.

2.3 Environmental Considerations

2.3.1 UPS Room

The UPS is intended for indoor installation and should be located in a cool, dry, clean-air environment with adequate ventilation to keep the ambient temperature within the specified operating range (See [Environmental](#) on page 58 conditions in **Table 6.1** on page 57).

The UPS is cooled with the aid of internal fans. Do not cover the ventilation openings. Cooling air must enter and exit the cabinets freely to prevent overheating or malfunctioning.

The UPS is equipped with air filters behind the front doors. A schedule for inspection of the air filters is required. The period between inspections will depend upon environmental conditions.

When using bottom-entry cabling, the conduit plate must be installed.

NOTE:

- The UPS must be installed on concrete or other non-combustible surface.
- There is a potential risk to the operational integrity of an installed UPS system by the presence of foreign material inside or in the vicinity of the UPS module.
- This risk is especially high if conductive materials find their way inside the UPS module.
- The risk potentially involves damage to the installed UPS equipment and subsequent degradation or loss of power to the connected critical site load.
- Vertiv applies the highest safety standards in equipment design to ensure that no live parts are exposed to external contact, and also to ensure that the equipment is protected against the introduction of foreign bodies during operation. However, it is not possible for Vertiv to ensure that foreign bodies will not be introduced during on-site installation, or when the UPS doors and covers are open and the electrical terminals are exposed to allow power line connections to be made by the electrical contractor/installer.
- To prevent major disruption to site operations and risk to property and personnel, including the possibility of a fatality, each site's facility manager or construction manager must prevent foreign bodies from being introduced into the UPS module.
- All UPS modules are thoroughly inspected by Vertiv engineers before being placed into service and testing on-site. However, the person responsible for the site must ensure that the UPS module and the immediate surroundings are kept clean and free from any possible conductive material such as metal foil, food wrappers, cable shields, washers and other hardware, scrap metal and dust.
- If the UPS system is shut down after placement into service and testing are completed, the UPS room must be kept clean to avoid the possibility (during restart) of the considerable volume of air-flow produced by UPS operation to dislodge and/or drag any foreign bodies into the equipment, which would result in system failure and possible supply interruption to the critical site load, and several hours of downtime resulting from the damage typically associated with such events.
- If the UPS is left running/operational after placement into service and testing, the room must be kept clean to prevent foreign bodies from entering the UPS module via its forced-air flow.

2.3.2 Storing the UPS and Batteries for Delayed Installation

If the UPS system will not be installed immediately, store it indoors in a clean, dry and, cool location (See [Environmental](#) on page 58 conditions in **Table 6.1** on page 57). If the system includes a battery cabinet, the batteries' requirements dictate the storage conditions. Unpack, install and charge batteries as soon as possible after delivery.

NOTE:

- Risk of failure to properly charge batteries can cause permanent damage to batteries and void the warranty.
- Batteries will discharge during storage. Batteries must be recharged as recommended by the battery manufacturer. A notice of "Charge Before Date" is affixed to each cabinet that has batteries inside. The "Charge Before Date" is calculated based on storing the batteries at 77°F (25°C). Storage at a higher temperature will increase the rate of self-discharge, which requires earlier recharge. Consult the battery manufacturer on how to determine when the batteries need to be recharged.

2.3.3 Installation Altitude

The maximum operating altitude of the UPS, without derating, is 3300 ft (1000 m). For higher altitudes, the UPS complies with IEC/EN 62040-3.

2.4 Positioning

The cabinet is structurally designed to permit lifting from the base with a forklift, pallet jack or similar equipment.

Access to the power terminals, auxiliary terminal blocks and power switches is from the front and top.

The doors and top low-voltage cover can be opened for access to the power connection bars, auxiliary terminal blocks and power isolators. The front door can be opened 90 degrees for service and installation.

The cores will have outer labeling indicating core position relative to the I/O Box assembly. See **Figure 2.1** below for label description.



CAUTION: Follow installation instructions carefully. Ensure all equipment in UPS lineup has the same serial number.

Figure 2.1 Core Positioning

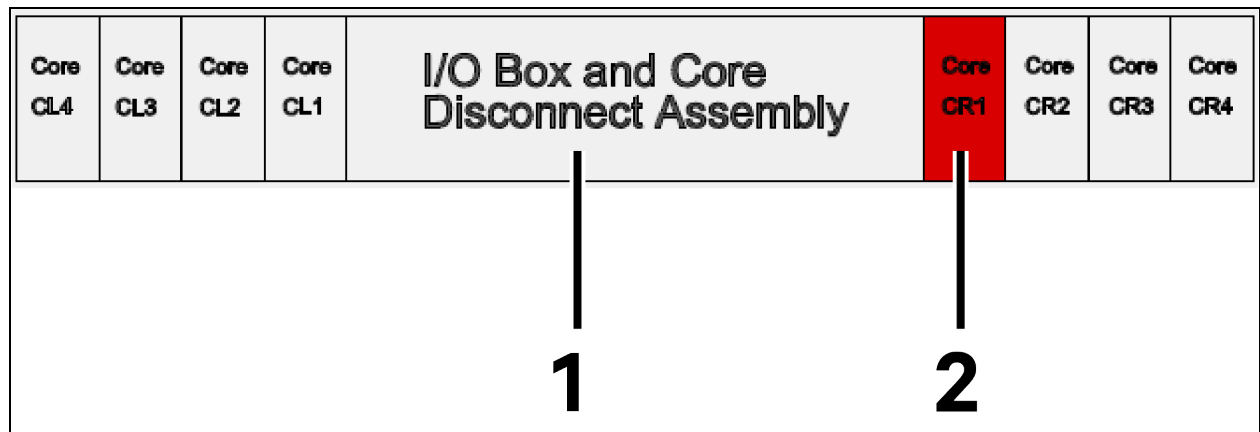

Number	Description
1	Front
2	Install this core here

2.4.1 Moving the Cabinets

Plan the travel route between the point of arrival and the unit’s position to make sure that all passages are wide enough for the unit and that floors are capable of supporting its weight. Check that doorways, lifts, ramps and so on are adequate and that there are no impassable corners or changes in the level of corridors that would prevent passage.

Ensure that the cabinet weight is within the designated surface weight loading (kg/cm²) of any handling equipment. See 'Physical Characteristics' in the **Table 6.1** on page 57.

Move the UPS with a forklift or similar equipment. The bottom structure of the cabinet will support the unit only if the forks are completely beneath the unit. The optional battery cabinets also should be moved with a forklift or similar equipment.

Ensure that any equipment used in moving the cabinet has sufficient lifting capacity to transport the unit. Care must be taken to protect the panels. Do not tilt the cabinet more than 15 degrees.

Handling with straps is not authorized.



WARNING! Risk of heavy unit falling over. Improper handling can cause equipment damage, injury or death. Because the weight distribution in the cabinet is uneven, use extreme care while handling and transporting. Take extreme care when handling UPS cabinets to avoid equipment damage or injury to personnel. Locate the center of gravity symbols and determine the unit weight before handling each cabinet. Test lift and balance the cabinets before transporting. Maintain minimum tilt from vertical at all times. For weights, See the **Table 6.1 on page 57 .**

Position the cores according to the labels provided on the cores. See **Figure 2.2** on the next page . Each core will have a visible label prior to unwrapping that indicates the core position relative to the I/O box assembly. **Figure 2.2** on the next page shows the I/O Box and Core panel labels (inside the cabinet doors).

Figure 2.2 Core Positions

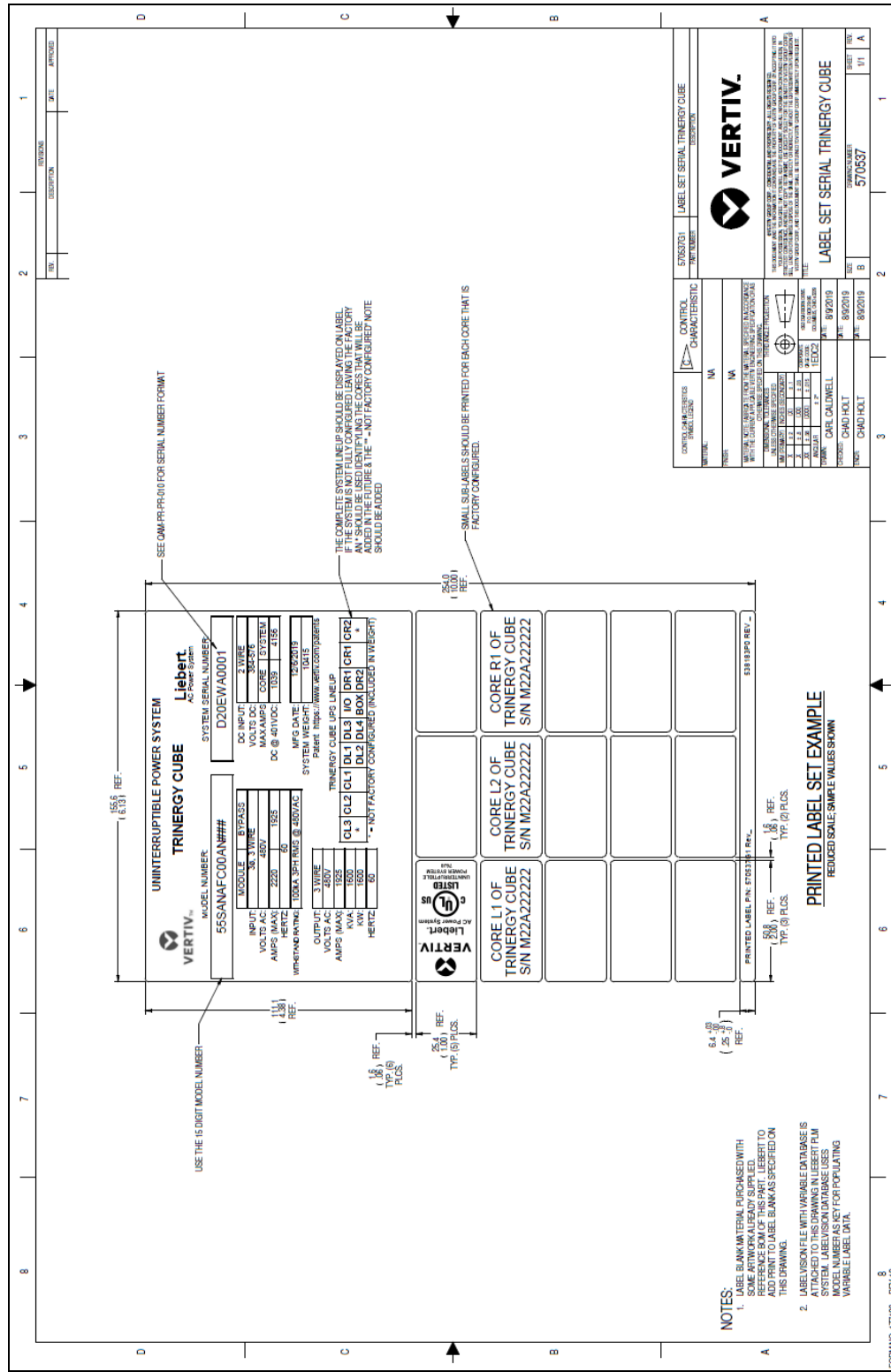

2.4.2 Clearances

The UPS has no ventilation grilles at either side or at the rear. Leave a distance of 24 in. (610 mm) between the top of the unit and any overhead obstacles or ceiling for service access and adequate air circulation. Clearance around the front of the equipment should be sufficient to enable free passage of personnel with the doors fully opened, about 50 in. (127 cm). In the rare instance of module replacement, 50 in. (127 cm) of clearance is required for the Service team to perform module replacement. 50 in. (127 cm) allows adequate clearance for both the module and the heavy-duty lift used by Service team to remove and replace the modules. If 50 in. (127 cm) is not available, then the Service team will instead replace components and subassemblies in the modules as part of their repair process.

2.4.3 Raised-floor Installations

If the equipment will be installed on a raised floor, mount it on a pedestal suitably designed to accept the equipment-point loading. Refer to the base view to design this pedestal.

2.4.4 Kick Plate Installation — Standard

Kick plates must be installed. If the unit will be installed in a position that does not permit access to rear of the UPS, install the kick plates before the unit is placed in its final position.

IMPORTANT! The UPS kick plates are located in the rear of each section.

2.4.5 UPS Side Panels

There are two painted side panels provided with each UPS. The side panels will be attached to the ends of the I/O box-core disconnect assembly upon delivery. These side panels must be removed and attached to the end of each side of the UPS after it is completely assembled (all cores attached to the I/O box-core disconnect assembly).

2.4.6 Floor Anchors — Optional

For seismic-resistant installations, special floor anchors must be used for the UPS and matching battery cabinets; See [Components required for seismic configuration](#).

2.4.7 Special Considerations for 1+N Parallel Systems

Consider the grounding configuration of your system before finalizing module placement. See [Ground Connection Configuration Guidelines](#) on page 30.

The cabling impedance must be closely matched to ensure proper load-sharing. Mismatched impedance may cause an overload on one module in a 1+N system, triggering a shutdown and loss of power to the connected load. Mismatched cable impedance is amplified when a 1+N system is operating on bypass because the power on the bypass path is not controlled. We recommend matching the impedance in the bypass path of paralleled systems as closely as possible to ensure good bypass current sharing.

The UPS contains an internal inductor in the bypass path to minimize the effects of cable impedance mismatch.

The impedance mismatch can also be minimized by controlling the wiring length of each unit. The design and the layout of the UPS system and associated panels and cabling should be examined closely to ensure that cable lengths and impedance are closely matched.

For Vertiv™ Liebert® Trinergy™ Cube systems, the total combined cable length of the bypass feeder cables and the module output cables for each module must be within 5% from maximum to minimum. The combined cable length is the sum of the length from the common source feeding all the modules to the common output switchboard.

If the cabling impedance need to be greater than 5% or the total, planned system load exceeds more than 85% per module, contact your Vertiv representative to calculate whether the system will result in an overload condition when operating on bypass.

When bringing a 1+N system on line for the first time or after removing one unit, we recommend checking the bypass current mismatch. To check the bypass current mismatch:

1. Place a load on the bypass of each UPS module.
2. View the output current of each unit.

The accuracy of the currents displayed on the UPS module is sufficient for this check. If the mismatch is greater than 5%, the bypass impedance must be balanced or the load must be limited to less than the maximum rating.

The output switchboard for any 1+N system must be configured with one Module Output Circuit Breaker (MOB) for each UPS module that is to be connected to that switchboard. The breaker must be equipped with auxiliary contacts that will be monitored by the UPS in order for interlocks to function properly and for the HMI to indicate the bypassed status of the module.

We recommend selecting breakers that work with current levels that may occur when switching a module onto the active bus. Breakers with adjustable instantaneous settings should be adequate to achieve this.

For further information about matching cable impedance or refer to Performance Improvements with Sharing Inductors in Distributed Static Switch UPS Systems on the Liebert® Trinergy™ Cube product page at www.Vertiv.com, or contact Vertiv™ support, <http://www.Vertiv.com/en-us/support/>.

2.4.8 Unpacking and Unloading the Cabinet from the Pallet

Take the utmost care when removing the packaging to prevent damage to the equipment. Check all packaging materials to ensure that no important items are discarded.

Once the packaging is removed, take the UPS off the pallet by removing the retaining screws. See for the appropriate drawing for your system.

Once the retaining screws are removed, lift the unit off the pallet using a fork lift.

Do not remove the retaining brackets from the UPS because they are used to fasten the UPS to the floor, except where seismic compliance is required and the optional seismic anchoring kits are used.

2.5 System Configuration

A UPS system comprises a number of equipment cabinets, depending on the individual system design requirements. In general, all the cabinets in an installation are the same height.

NOTE: If you are bolting cabinets together, remove the side panels before beginning installation.

- **Stand-alone, interconnected battery cabinets**—See in **Figure 2.3** below, with the battery-junction cabinet on one end. The battery cabinets are interconnected with the battery wiring cabinet, but are not connected to the right side of the UPS. In this configuration, the battery junction cabinet may be on either end or between the battery cabinets.
- **Stand-alone battery system**—The battery cabinet system stands alone. In this configuration, there is no junction cabinet and the battery cabinets are not connected to the UPS. There are no configurations that will have a battery cabinet attached to a Vertiv™ Liebert® Trinergy™ Cube module. Battery power cables are routed directly to the DC busbars in the UPS I/O cabinet.

NOTE: Make sure that you complete all of the connections detailed in the “Interconnection Details” drawing before making any power cabling connections. The interconnects are very hard to access after the power wiring is complete. See , for the appropriate drawing for your system.

The detailed arrangement and cabinet dimensions for your UPS system are described in the installation drawings. Refer to the appropriate illustrations for your unit included herein.

Figure 2.3 Stand-Alone, Interconnected Battery Cabinets

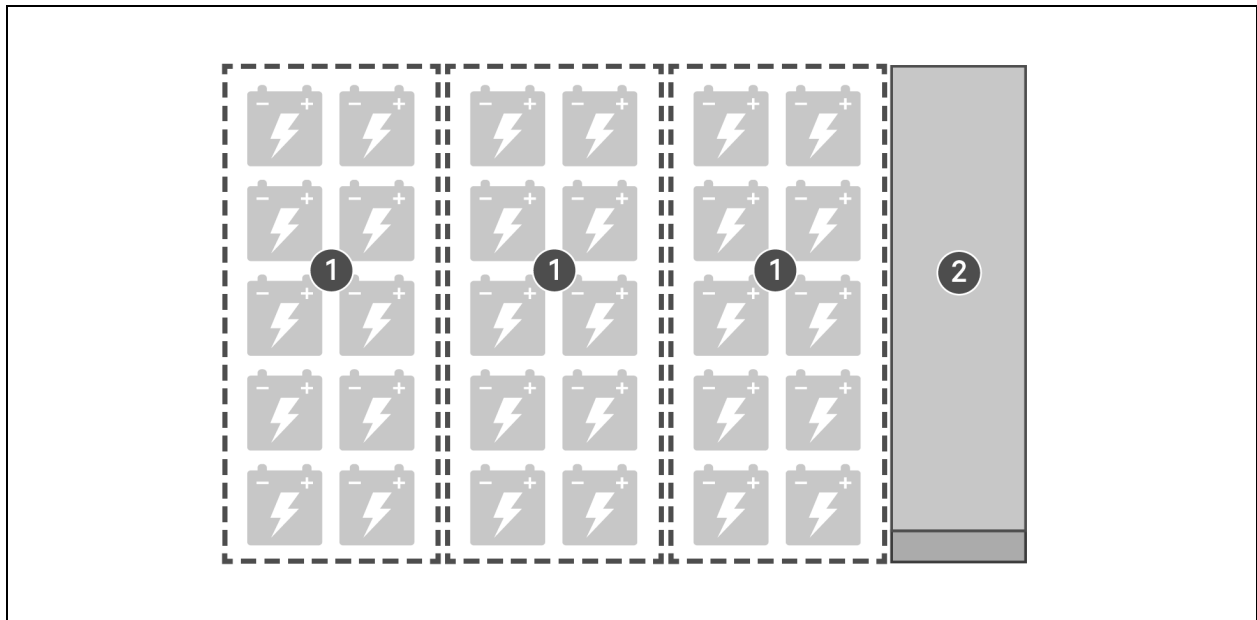

Item	Description
1	Battery cabinet
2	Junction cabinet

2.6 Physical Appearance

Figure 2.4 Vertiv™ Liebert® Trinerger™ Cube 2400A I/O Box (Front View with Core Disconnect Right and Core Disconnect Left)



Number	Description	
1	QS1	Input Switch (Core Disconnect)
2	QS1	
3	QS1	
4	QS1	
5	QS4	Output Switch (Core Disconnect)
6	QS4	
7	QS4	
8	QS4	
9	BFD	Backfeed Disconnect (I/O Box)

Figure 2.5 1600kVA System-Single-Input (No Panels, Front)

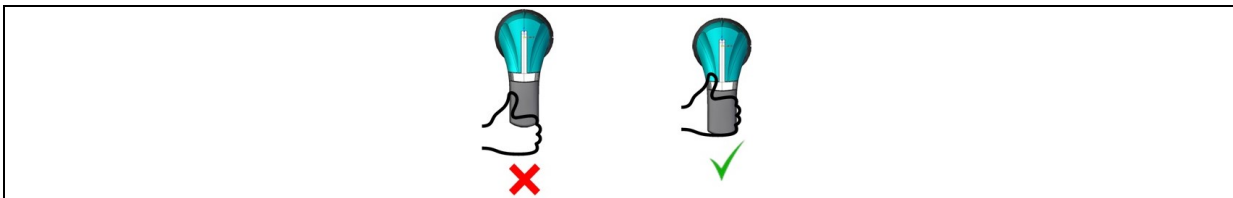

Figure 2.6 How to Handle the Switches

**To lockout a switch:**

In order to lockout the switch, it must be in the off position. Once in the off position, the operator can raise the center tab on the switch to expose the lockout mechanism of the switch.

2.7 Power Cable Busbars

The power cables for the I/O box can enter through the top of the I/O box section or the bottom of the I/O box. The DC power cables can enter the top or bottom of the core disconnect sections.

The detailed cabling and connection for your UPS system is described in the installation drawings. In addition to the following instructions, refer to the appropriate illustrations for your unit included herein, which lists the drawings by number, UPS model, and options.

Input power, from utility power, connects to the UPS through an input/output cabinet.

DC power source connections are available in each core disconnect cabinet.

2.8 Assembly Procedure for I/O Box 2400A with the Cores (Right/Left Side CORE)

To assemble an I/O Box 2400A with the cores (right/left-side cores):

1. Remove the IO Box/core disconnect assembly and cores from the pallet by removing the mounting screws.
2. Remove the end panels on both sides of the IO Box/core disconnect assembly and set aside for a later step in the assembly procedure.

Figure 2.7 Unpacking the I/O Box 2400A

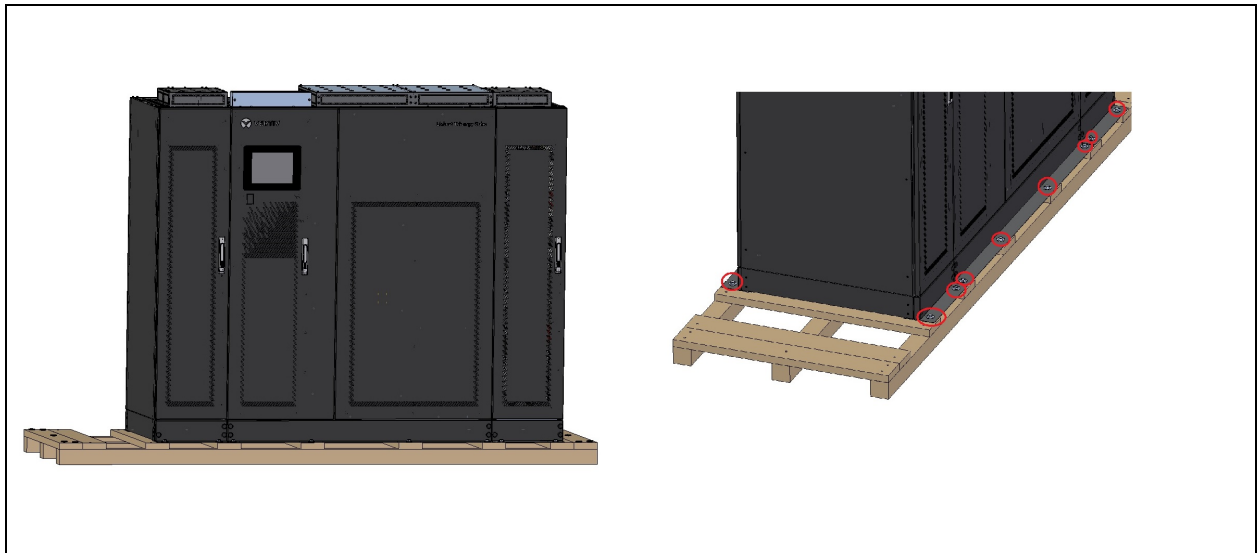

3. Appropriately position the cores according to the outer labels.
4. Attach the union plates at the top of the core disconnect to core interface and core to core interface as shown in the figures below. Note: this is the only mechanical connection between the core disconnect to core and core to core.

Figure 2.8 Connections I/O Box 2400A and Cores (Right Side, Front View Top)

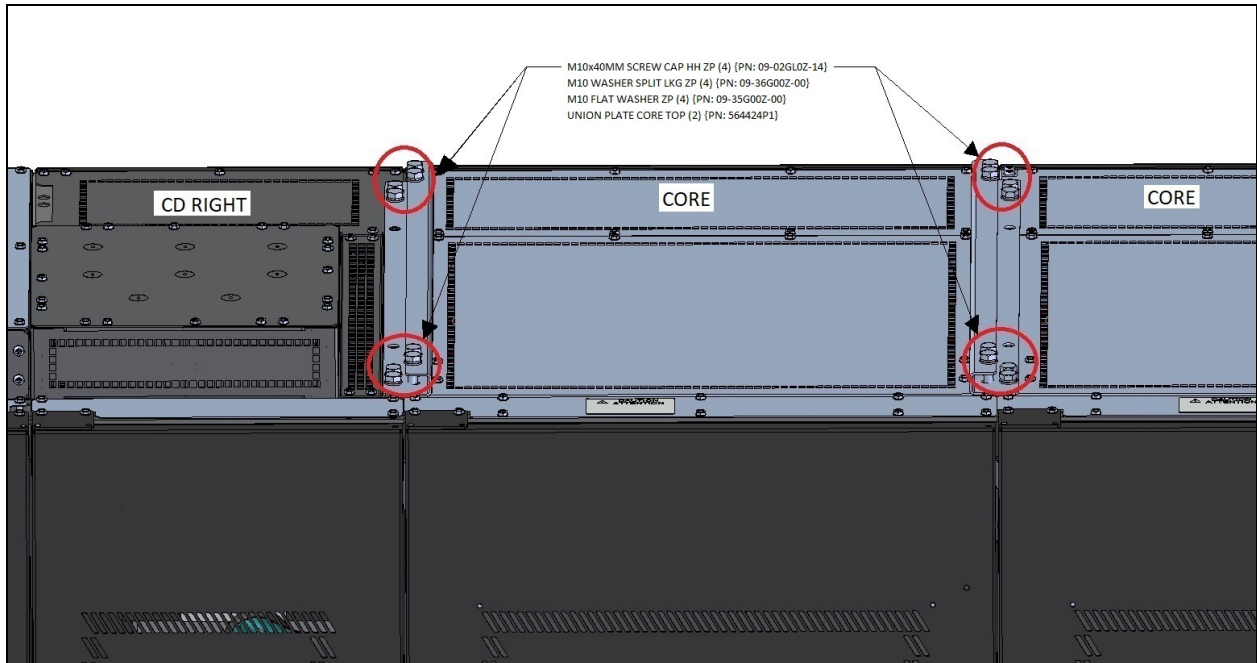
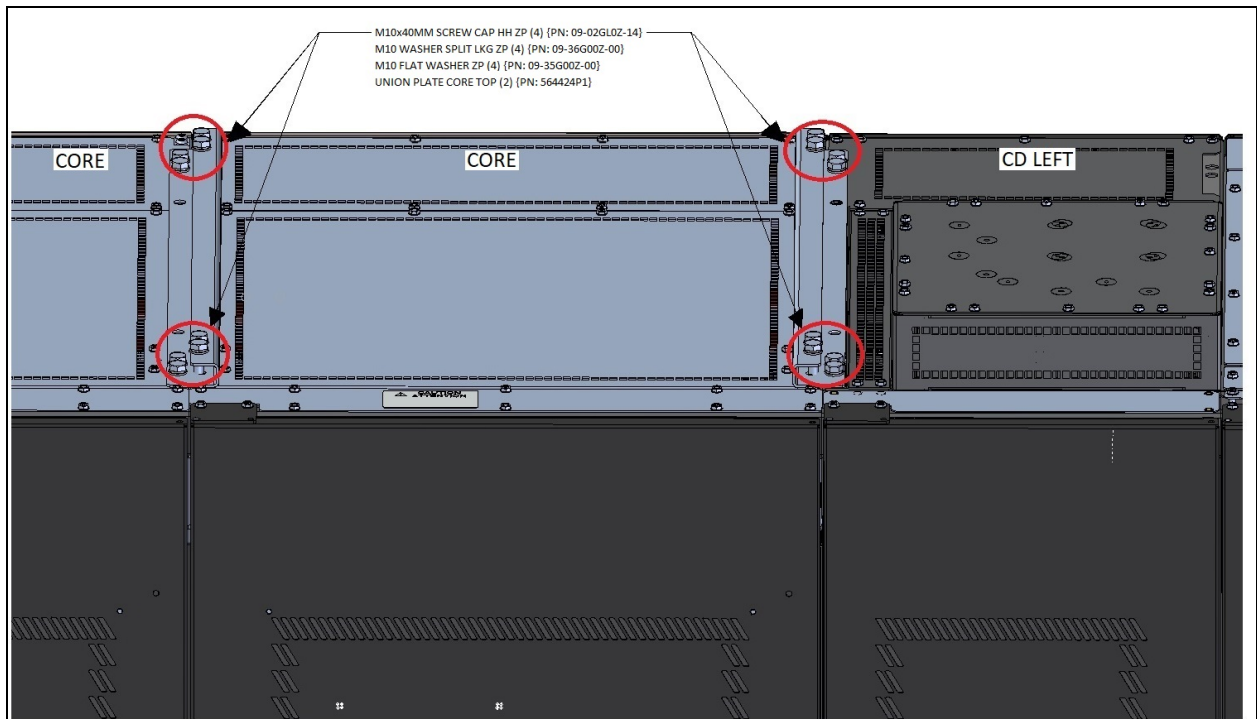

Figure 2.9 Connections I/O Box 2400A and Cores (Left Side, Front Top View)



- Once the union plates are all attached, connect the ground cables at the bottom of the UPS between the core disconnect to core and each core to core interface as See in **Figure 2.10** on the next page and **Figure 2.11** on page 17 . The ground cables are located inside the bottom of the cores.

Figure 2.10 Ground Cable 1

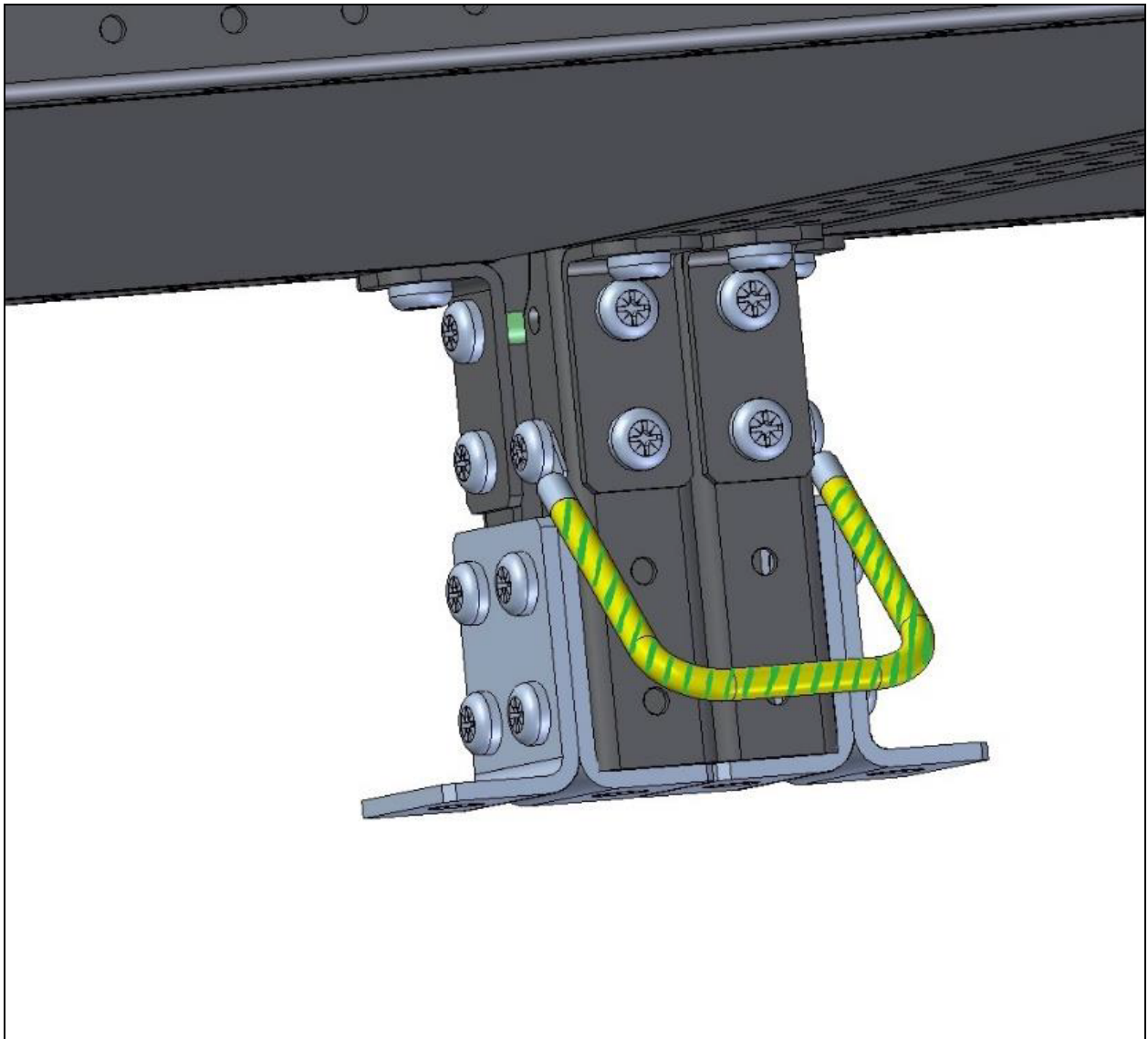
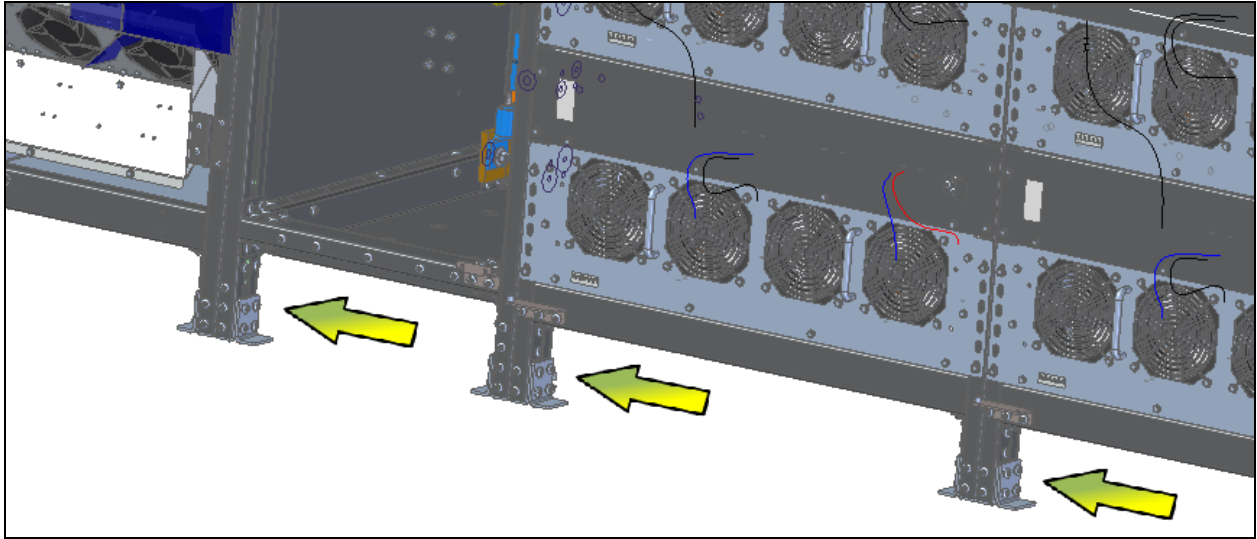

Figure 2.11 Ground Cable 2



2.8.1 Power Connections (Core and I/O Box)

In the case of connection of two Cores, the installer must wire the first and the second subsequently.

The power connections (See **Figure 2.12** on the next page and **Figure 2.13** on page 19) on the front of the Core disconnect are :

- A - B - C - Line Power Input
- A - B - C - UPS Output to Load
- D-, C+ - Battery Terminals

Figure 2.12 Power Connections, Right-Hand Core Disconnect

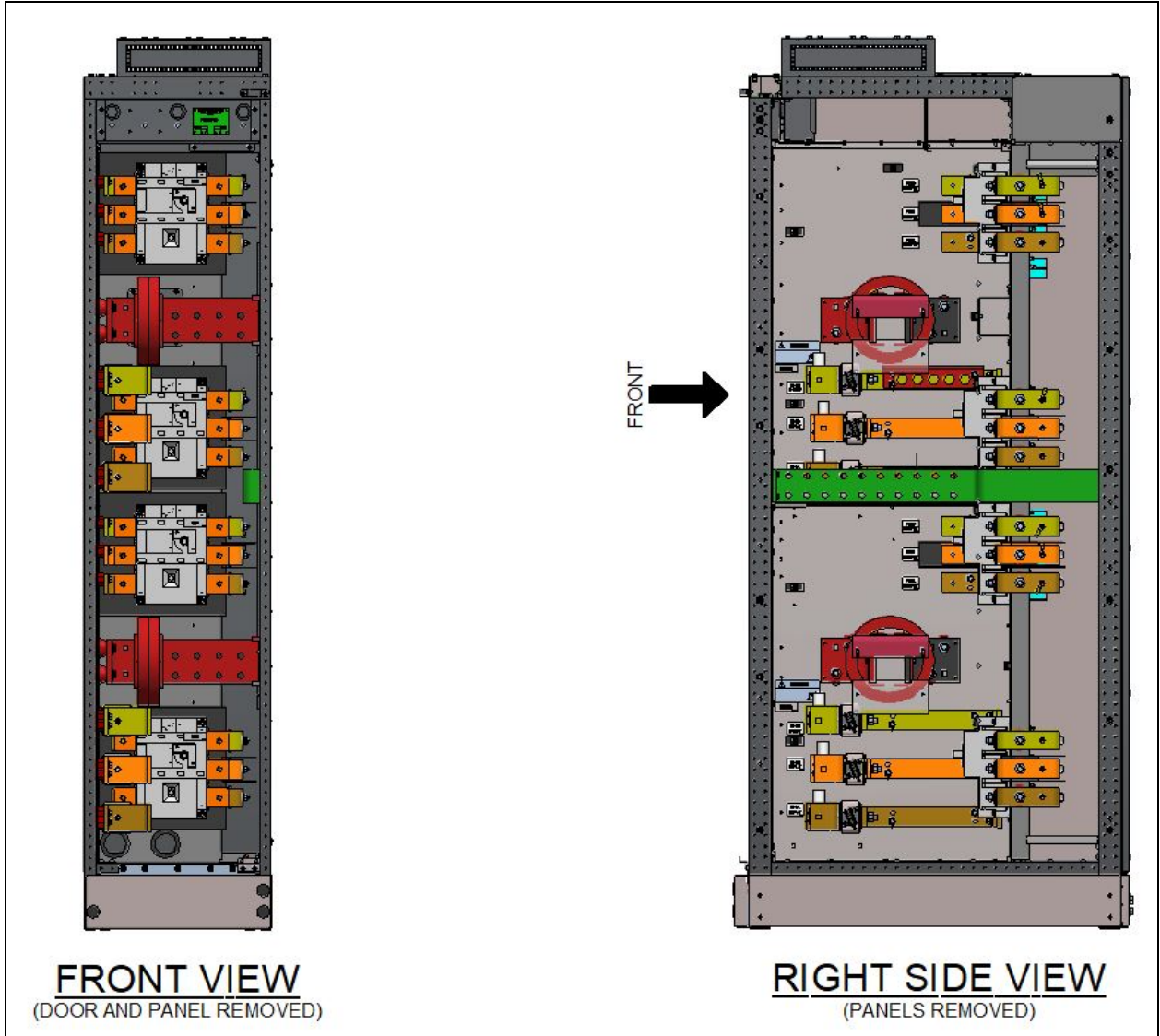

Figure 2.13 Power Connections, Left-Hand Core Disconnect

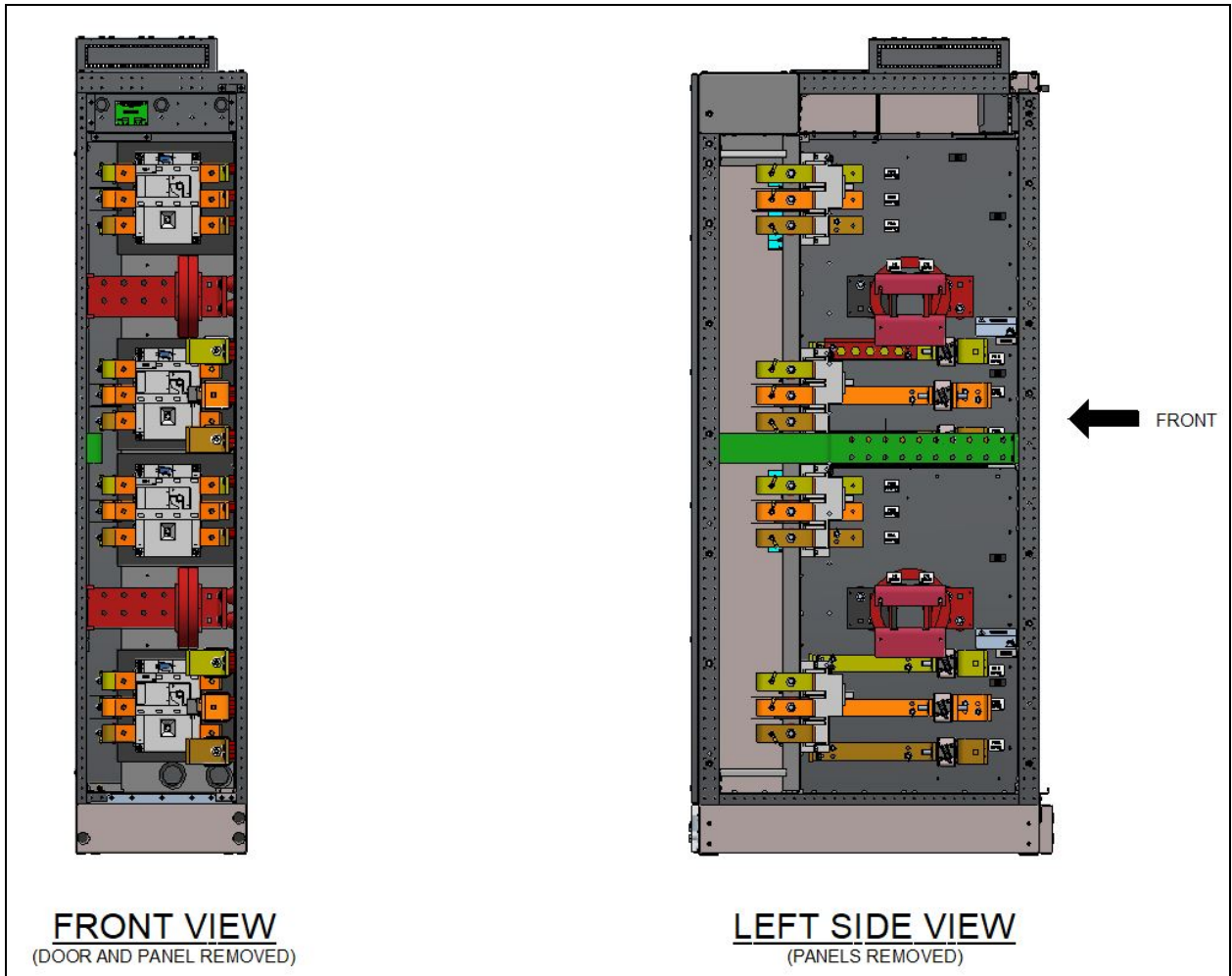

Figure 2.14 Customer Power Connections I/O Box 2400A

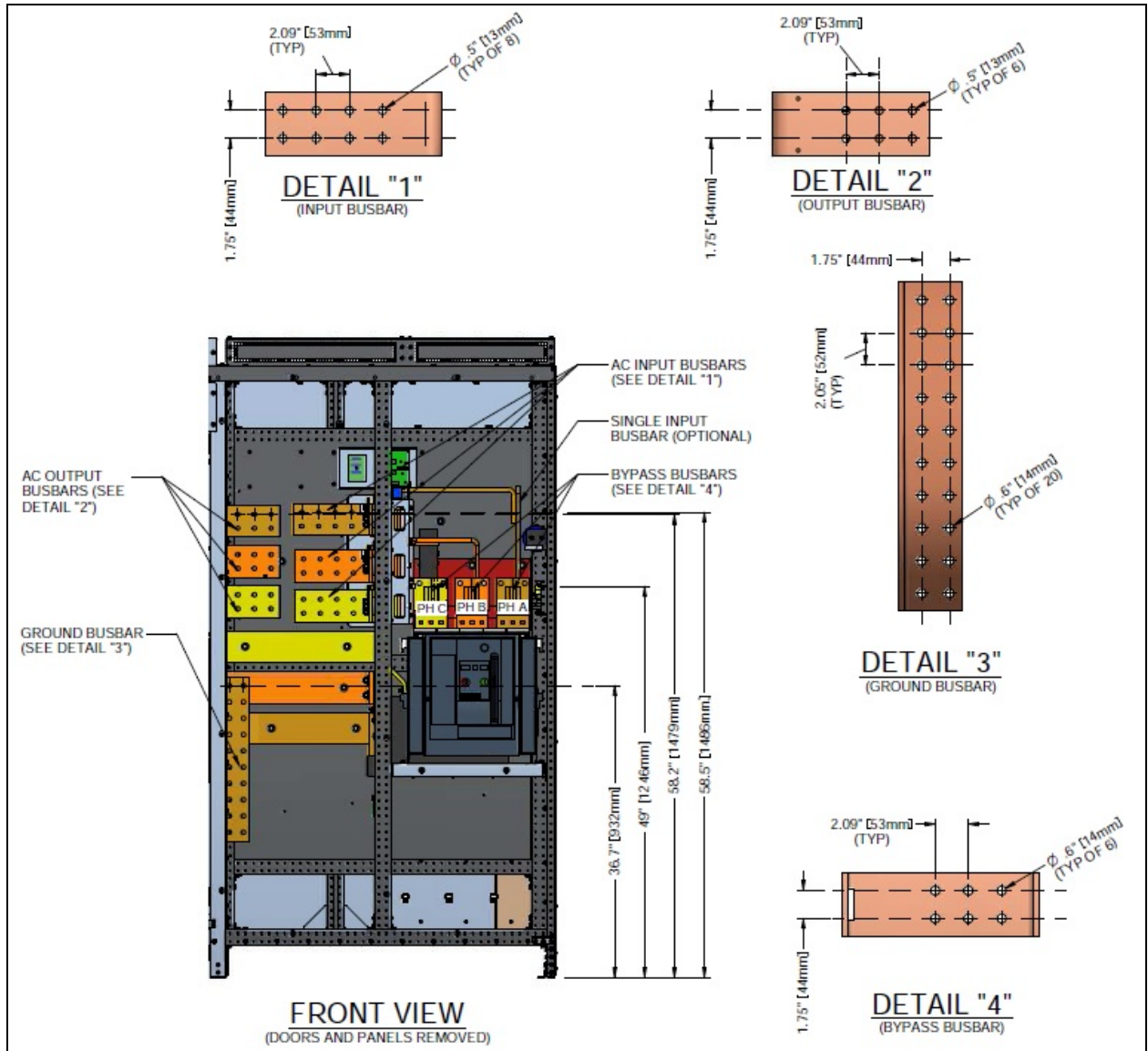
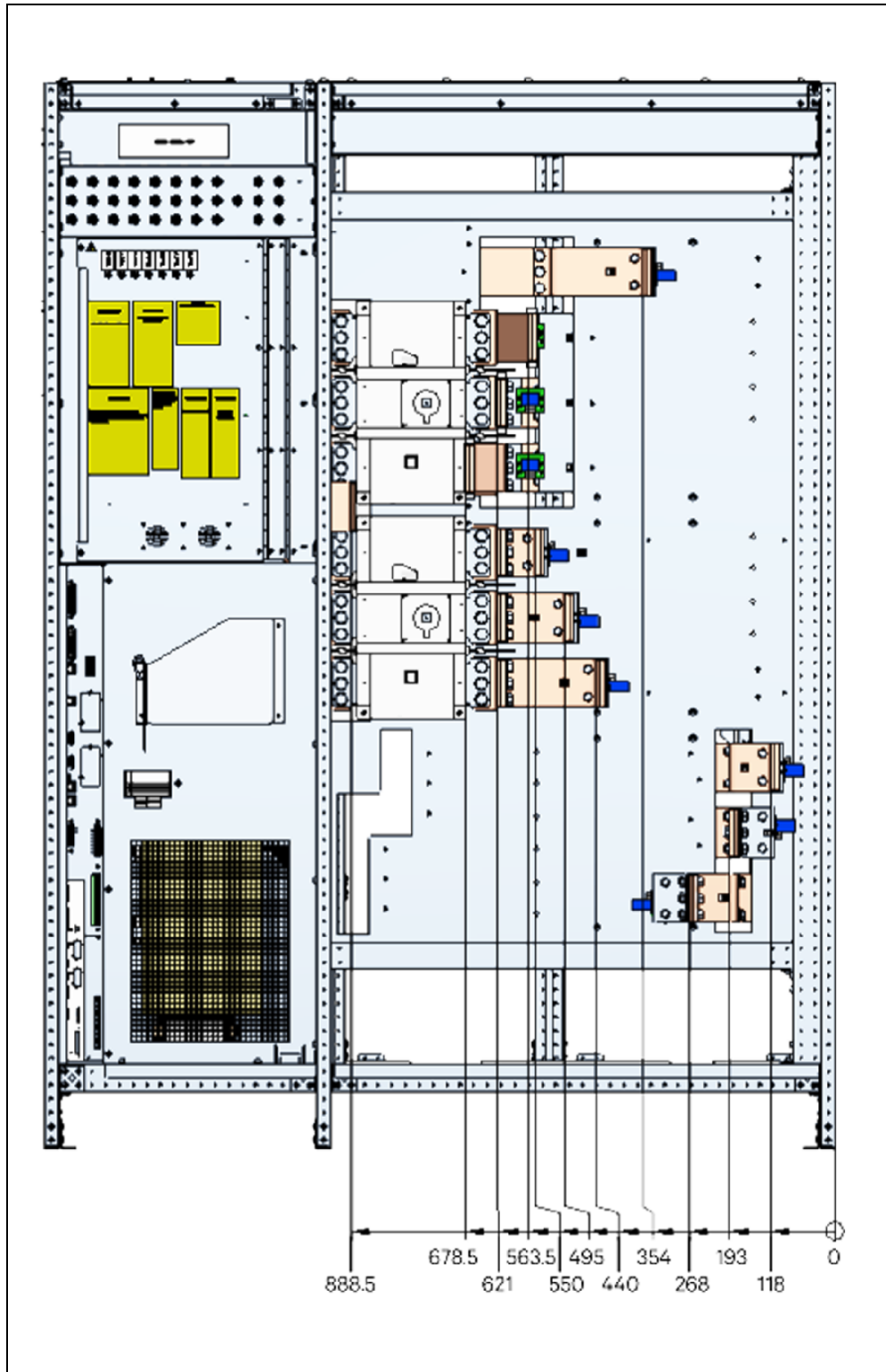

Figure 2.15 Customer Power Connections I/O Box 2400A Connection Point Location



2.8.2 Connection for Parallel UPS: Distributed Parallel System Cable Connection - XP019A, XP019B

A distributed parallel system must be connected to parallel cables for normal operation.

This interface is used for paralleling two or more UPSs with each other.

It enables data exchange between UPS electronics so that the UPS can provide a common output. The interface is SELV-isolated from UPS primary circuits.

⚠ WARNING! This interface and its function are for authorized Vertiv service technicians only. Do not remove any connected cable from this interface or connect any cable to it.

These cables are connected between the system to pass control signals which govern system synchronization, load sharing, battery charge current sharing (in a common battery installation), load transfer operation, and other general control and alarm functions. These signals are necessary to ensure correct system operation, and built-in redundancy allows the system to function should one of the cables become disconnected. For wiring terminations, refer to 10042099DRW.

Figure 2.16 Connection Parallel Signal Bus Cables (Internal to UPS)

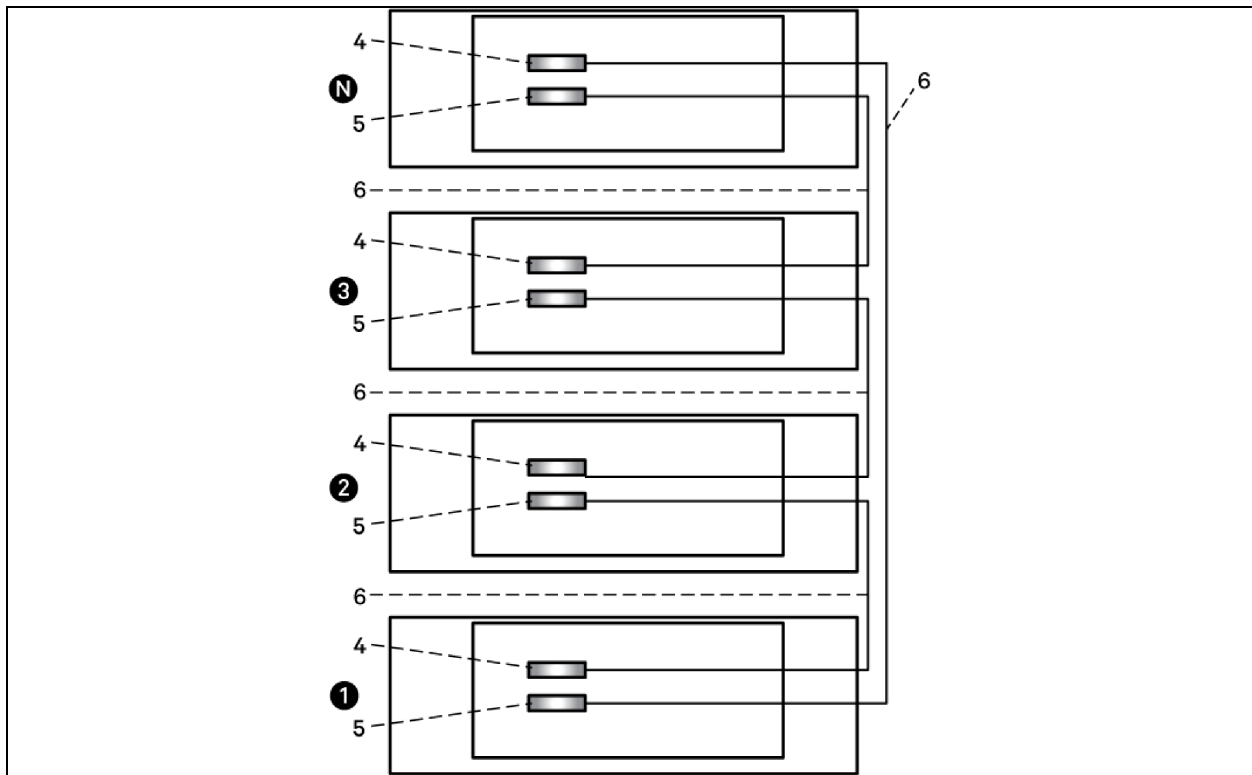

Item	Description
1	UPS #1
2	UPS #2
3	UPS #3
N	UPS #N

Item	Description
4	XP019A
5	XP019B
6	18 Conductor/9 pairs, 22 AWG Belden 8774 or Equivalent

The maximum length of the cable used to connect the various systems in parallel is 130 ft. (40m); for the UPS Distributed Parallel Application see the Vertiv™ Liebert® Trinergy™ Cube Operation Guide.

This page intentionally left blank

3 Connectivity

3.1 UPS Signal Wiring Interconnecting the Communication Cables

The internal connectivity panels are placed in the Core and in the I/O Box as shown the figures below.

To access the connectivity panel, remove the Core and I/O Box connectivity cover panels.

Replace the Core and I/O BOX connectivity cover panels when the procedure is complete.

The signal wiring passes in the upper part inside the machine.

Figure 3.1 Core - Connectivity panel

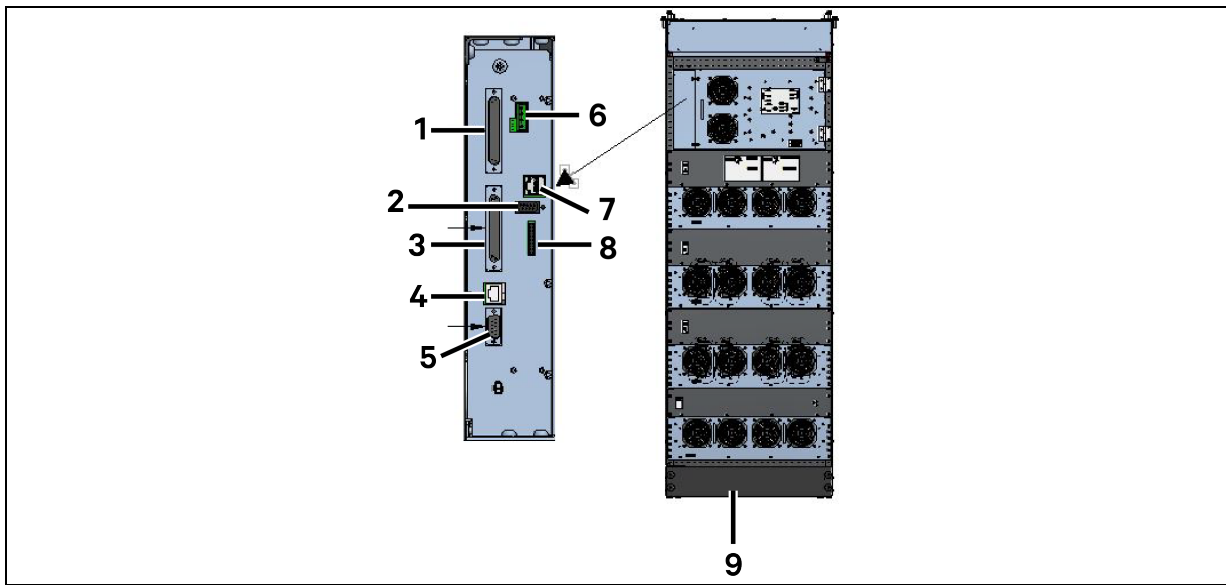

Item	Description
1	XM12
2	Serial port for CBI and motherboard programming
3	XF13
4	PPVIS connection
5	XP11
6	Core TB-1154 for external BIB connection, pin 1 closest to top of Core
7	CAN monitor communications
8	Jumper access to allow for CBI or motherboard programming. Pin 1 located at bottom right of header section
9	CORE 400 kVA

Figure 3.2 I/O BOX 2400A - Connectivity Panel

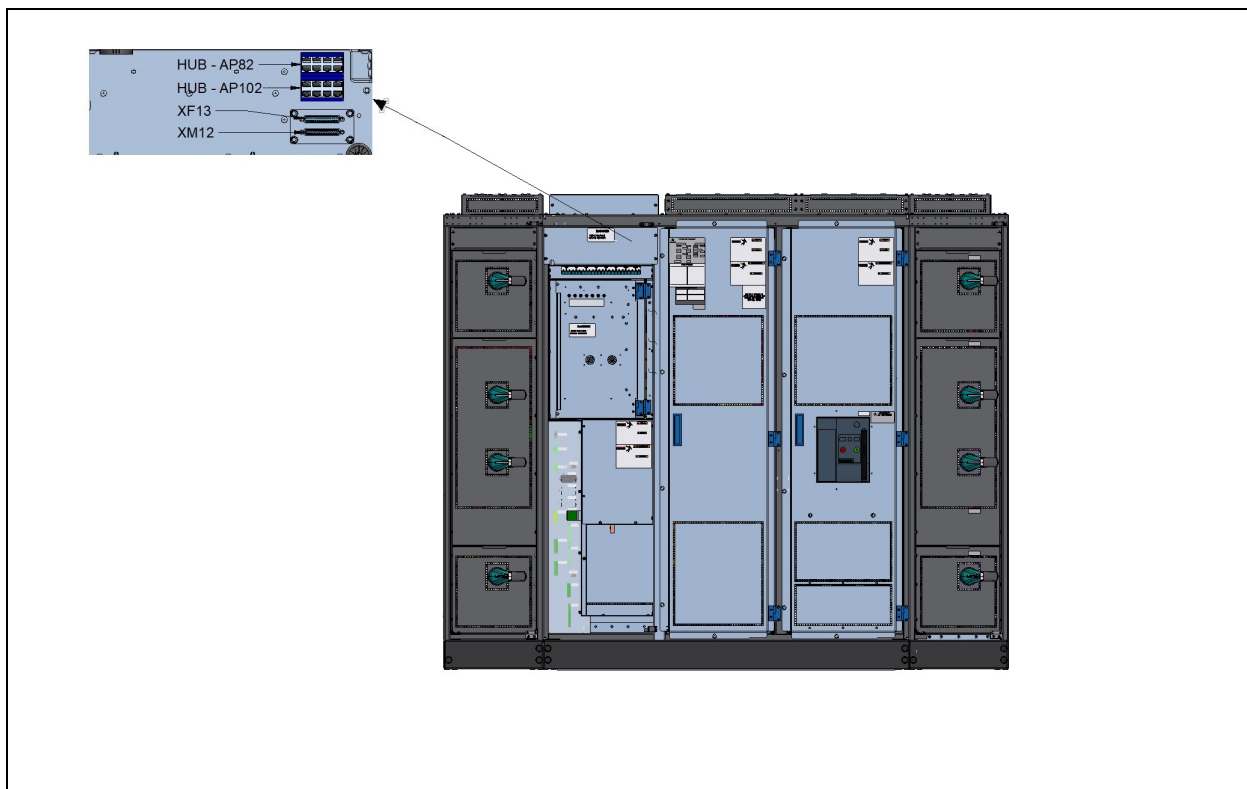

The cable kits used in each system vary depending on the configuration and the number of Core Disconnects and Cores installed.

For reference purposes, two different systems are shown in this manual. For all other possible configurations, contact technical support.

Figure 3.3 Interconnecting the Parallel and RJ45 Cables, I/O Box 2400A, Two Cores on the Right, Two Cores on the Left

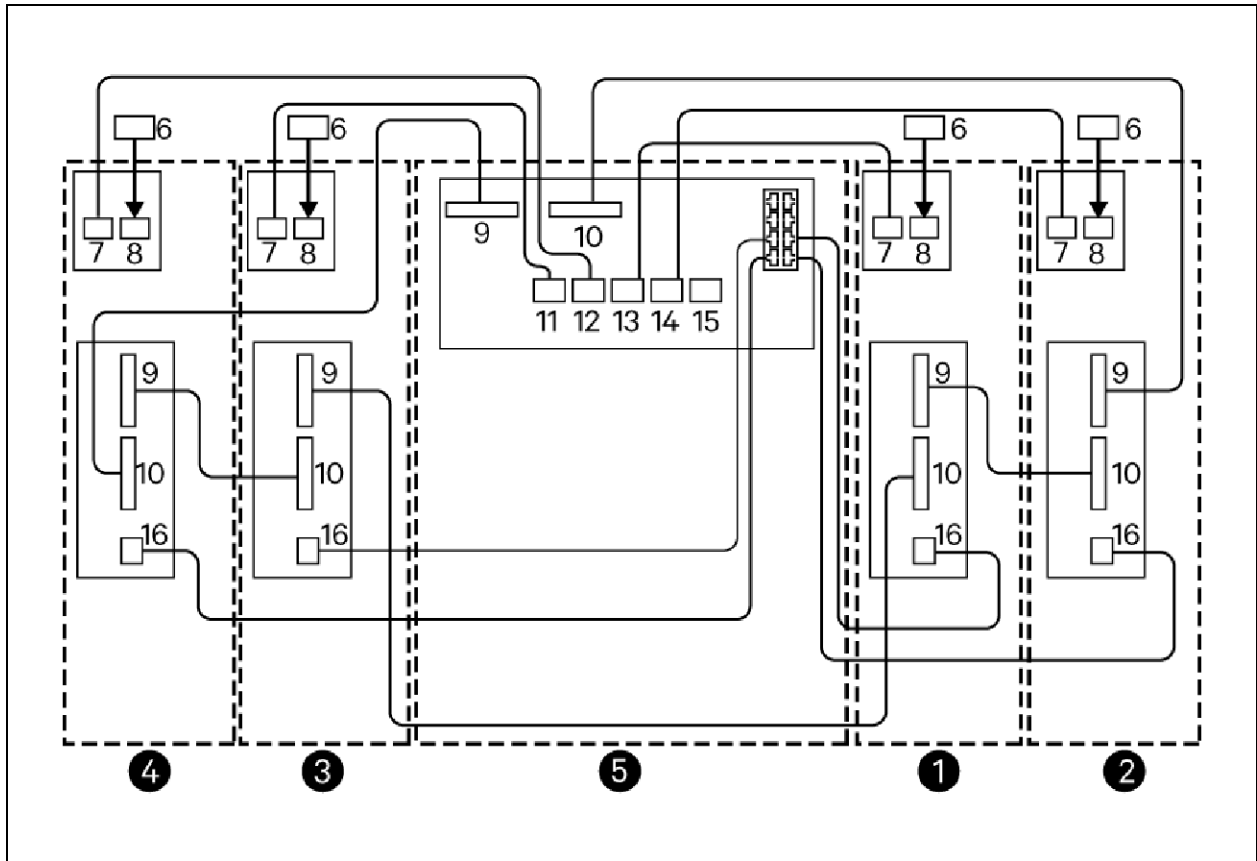

Item	Description	Item	Description
1	Core 1	9	XM12
2	Core 2	10	XF13
3	Core 3	11	X32
4	Core 4	12	X33
5	I/O Box	13	X34
6	NTC	14	X35
7	X5	15	X36
8	X4	16	XP8

3.2 Customer Signal Wiring

Vertiv™ Liebert® Trinergy™ Cube is equipped with the following interfaces:

- XP019A/B - 18/20-pole connectors respectfully for parallel connections (B2B board),
- XP3 - RJ-45 interface. For external synchronization. (used for future applications),
- XP29 - 3-pole screw connector for backfeed output contact,
- XP60 - Slot for Vertiv™ Liebert® LIFE™ modem,
- XP61 - Slot for connectivity products (used for future applications),
- XP2 - RJ-45 connection with battery interface board (CIB board),
- XP3A - Serial interface for service (CIB board),
- XP6 - Serial interface for external Liebert® LIFE™ (CIB board),
- XP10A - RJ45 connected to MUN Ethernet 1 (CIB board). Initially not enabled.

Once security protection is activated, will be used for Liebert® LIFE™ over IP connection:

- XP14 - RJ-45 Ethernet interface for service and commissioning only (CIB board),
- XP10 - EPO connector,
- XP11 - Input connector (I/O board),
- XP12 - Output connector (I/O board),
- VL1-VL2 - LEDs for XP10 - EPO,
- VL3-VL10 - LEDs for XP11 - I/O board.

See to [Control and Communication Cabling](#) on page 35 for more detail on the customer signal wiring interface.

4 Electrical Installation

These guidelines are for qualified installers who must have knowledge of local wiring practices pertaining to the equipment to be installed.



WARNING! Risk of electrical shock. Can cause injury or death. The UPS contains high AC and DC voltages. Check for voltage with AC and DC voltmeters before working within the UPS. Only properly trained and qualified personnel wearing appropriate, OSHA-approved PPO should prepare to install or install the UPS.

4.1 External Protective Devices

For safety, it is necessary to install circuit breakers in the input AC supply and external battery system. Given that every installation has its own characteristics, this section provides guidelines for qualified installation personnel with knowledge of operating practices, regulatory standards and the equipment to be installed.

External over-current protection must be provided. See [Current-versus-time curves of inverter overload capacity](#), for overload capacity.

4.2 Power Cable Requirements

The UPS requires both power and control cabling. Run all shielded and unshielded control cables separately from the power cables and in metal conduits or metal ducts that are electrically bonded to the metalwork of the cabinets they are connected to.

The cable design must comply with the voltages and currents in **Table 6.4** on page 60, through **Table 6.7** on page 61, follow local wiring practices, and take into consideration the environmental conditions (temperature and physical support media), room temperature and conditions of installation of the cable, and the system's overload capacity (See [Specifications](#) on page 57).

Electrical power connections must set so that phase A, phase B, and phase C are in a clockwise rotation from the UPS source.



WARNING! Risk of electrical shock. Can cause injury or death. Before cabling the UPS, ensure that you are aware of the location and operation of the external isolators that connect the UPS input/bypass supply to the power distribution panel. Check that these supplies are electrically isolated, and post any necessary warning signs to prevent them from being connected to the UPS or other system cabinets.



AVERTISSEMENT Risque de décharge électrique pouvant causer des blessures graves, voire mortelles. Avant de procéder au câblage du système ASC, assurez-vous que vous êtes au courant de l'emplacement et du fonctionnement des isolateurs externes qui raccordent l'alimentation d'entrée ou de dérivation au panneau de distribution électrique. Vérifiez que ces raccords sont isolés électriquement et installez tous les panneaux d'avertissement nécessaires pour empêcher leur utilisation accidentelle.

When sizing battery cables, a maximum volt drop of 2VDC is permissible at the current ratings given in **Table 6.7** on page 61.

The following are guidelines only and are superseded by local regulations and codes of practice where applicable:

- The grounding conductor should be sized according to the fault rating, cable lengths, type of protection, etc. The grounding cable connecting the UPS to the main ground system must follow the most direct route possible.
- Using smaller, paralleled cables for heavy currents can ease installation.
- AC and DC cables must be run in conduit according to local codes, national codes and standard best practices. This will prevent creation of excess EMI fields.

4.3 Sizing the Input Breaker that Feeds the UPS

Nominal input current (considered continuous) is based on full-rated output load. Maximum current includes nominal input current and maximum battery recharge current (considered noncontinuous).

Continuous and noncontinuous current are defined in the NEC.

Maximum input current is controlled by the current limit setting, which is adjustable. Values shown are for maximum current limit. If a smaller input feed breaker is used, the input current limit can be adjusted; see your Vertiv representative for more information. The input current limit should not be set less than 105% of the current needed to support the inverter at full load for normal operation.

This results in sufficient power to recharge the battery in a reasonable time and to operate over the published input voltage range.

4.3.1 Single or Dual Input Feeds

The UPS may be fed from single-reference sources or dual asynchronous sources. If a single-input configuration will be used, the utility source must be cabled to the rectifier input busbars.

NOTE: Make sure that you complete all of the connections detailed in the “Interconnection Details” drawing before making any power cabling connections. The interconnects are very hard to access after the power wiring is complete. See the appropriate drawing for your system.

The terminal details and connections for your UPS system are described in the installation drawings. Refer to the appropriate illustrations for your unit included herein.

4.3.2 Automatic Transfer Switches

If the UPS is fed from an automatic transfer switch, the UPS can transfer to and from an alternate out-of-phase source in double-conversion mode without applying a break-before-make delay to the automatic transfer switch operation.

4.4 Ground Connection Configuration Guidelines

The Vertiv™ Liebert® Trinergy™ Cube is compatible with solidly grounded wye sources or high-resistance ground systems, if compatible. See [High-Resistance Ground Systems](#) on page 34.

NOTE: Early production models may not be compatible with high-resistance ground systems.

Improper grounding is the largest single cause of UPS installation and startup problems. Grounding techniques vary significantly from site to site, depending on several factors.

Proper grounding should be based on the appropriate NEC sections, but safe and proper equipment operation requires further enhancements. The following pages detail recommendations for grounding various system configurations to ensure optimal UPS system performance.



CAUTION: The UPS ground lug must be solidly connected to the service entrance ground by an appropriately sized wire conductor per the NEC. Each conduit or raceway containing phase conductors must also contain a ground wire, both for UPS input and output, that are solidly connected to the ground terminal at each termination point. Conduit-based grounding systems tend to degrade over time. Therefore, using conduit as a grounding conductor for UPS applications may degrade UPS performance and cause improper UPS operation.

4.4.1 Three-wire Input Connections

IMPORTANT! Single-phase loads must not be directly connected to the output of a three-wire UPS configuration.

Please note that whenever the UPS module transfers to or from bypass, two AC sources (UPS output and bypass) are briefly connected together and circulating current must flow. In this configuration, the current flows through the ground path, possibly tripping ground-fault interrupters (GFIs) and distorting the output voltage waveform. Proper adjustment of GFIs is necessary to avoid unwanted tripping. The time delay should be set to at least 0.2 seconds to prevent tripping when the UPS performs a transfer or retransfer operation.

NOTE: Risk of improper installation. Can cause equipment damage. Failure to set the GFIs properly could cause loss of power to the critical load.

Figure 4.1 Grounding Diagram—Three-Wire Single-Module Systems

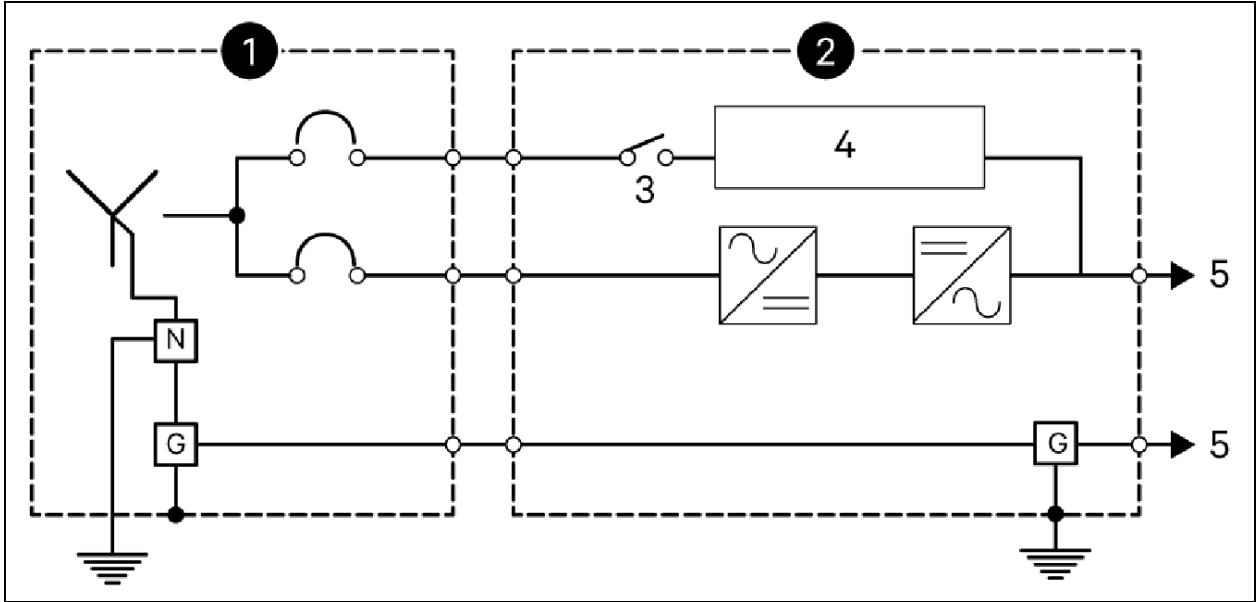

Item	Description
1	Source
2	UPS
3	Back-Feed Disconnect
4	Bypass Static Switch
5	To connected equipment

Figure 4.2 Grounding Diagram—Three-Wire Multi-Module Systems

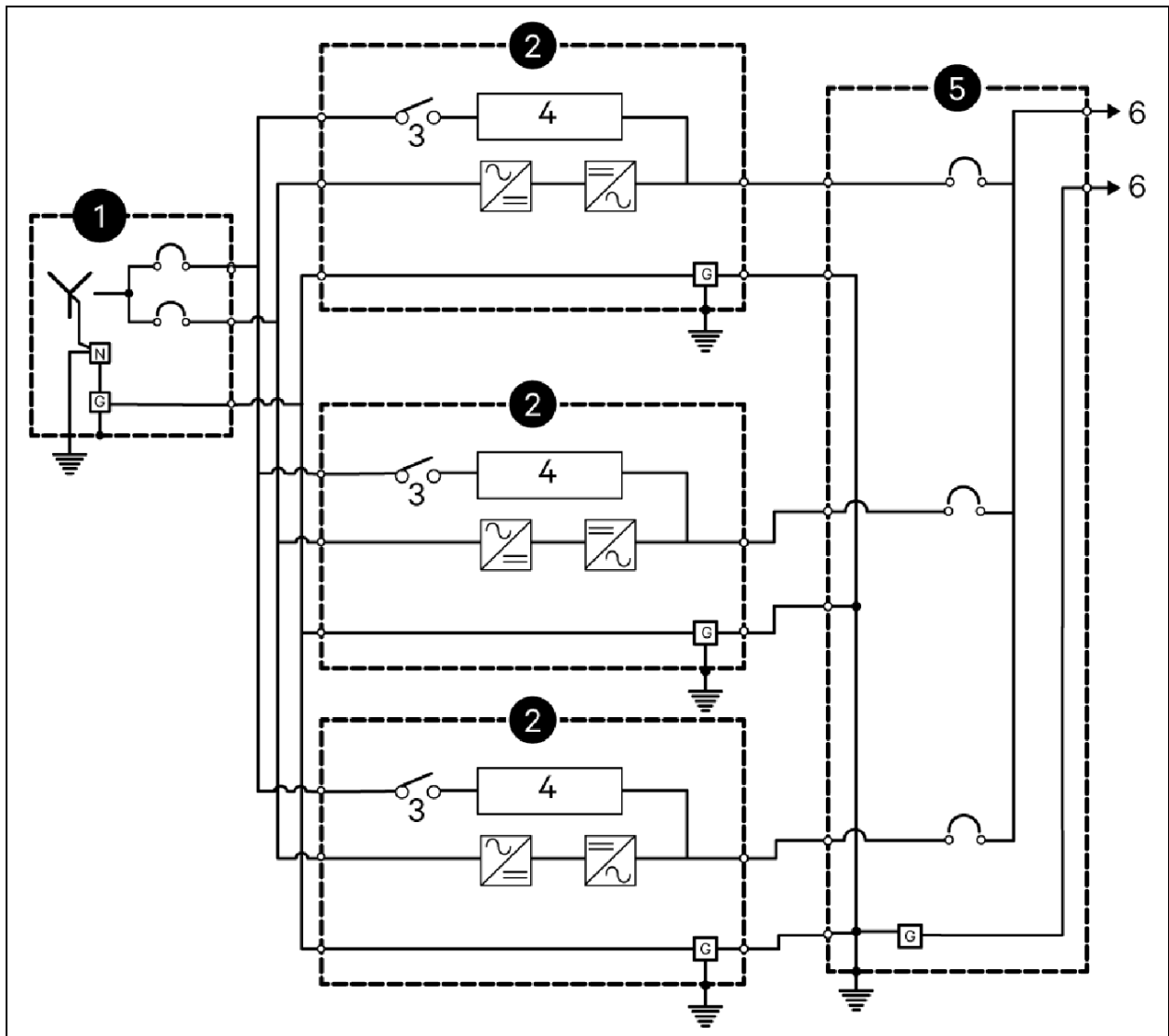

Item	Description
1	Source
2	UPS
3	Back-Feed Disconnect
4	Bypass Static Switch
5	Switchgear
6	To connected equipment

4.4.2 Recommended Grounding Configuration for Battery Systems

Battery cabinet systems must be connected as floating (ungrounded) systems.

Center-tapped or grounded battery systems are not possible with battery cabinet systems.

Whether the battery system is open-rack or cabinet, the metal rack parts or cabinet must be grounded to the UPS-module ground bus.

4.4.3 High-Resistance Ground Systems

The 400 – 1600 kVA UPS units are compatible with High Resistance Ground (HRG) applications. Contact the factory for HRG compatibility.

4.5 Connecting Equipment Ground Cables and Straps

The equipment-ground busbar is in the I/O section, described in the appropriate illustrations for your unit included herein.

All cabinets and cabling must be grounded in accordance with local regulations.



WARNING! Failure to follow adequate grounding procedures can result in electric shock hazard to personnel, or the risk of fire, should a ground fault occur. All operations described in this section must be performed by properly trained and qualified electricians or technical personnel. If any difficulties are encountered, contact Vertiv™ Technical Support, <http://www.Vertiv.com/en-us/support/>.

Once the equipment is positioned and secured, refer to the appropriate illustrations for your unit included in the documentation with the UPS and complete the following steps:

1. Open exterior and interior panels on the front of the I/O sections.
2. Connect the ground cable to the equipment-ground busbar in the I/O sections.

4.6 Connecting DC Input Power

NOTE: Make sure that you complete all of the connections detailed in the “Interconnection Details” drawing before making any power-cabling connections. The interconnects are very hard to access after the power wiring is complete. See [Technical Illustrations](#) on page 1 of the Appendix, for the appropriate drawing for your system. DC cable runs should be completed with like number of positive (+) and negative (-) conductors in each conduit or that positive (+) and negative (-) conductors need to be mixed in cable troughs.



WARNING! Risk of electrical shock. Can cause injury or death. The UPS contains high AC and DC voltages. Check for voltage with AC and DC voltmeters before working within the UPS. Only properly trained and qualified personnel wearing appropriate, OSHA-approved PPE should prepare to install or install the UPS.



WARNING! Risk of electrical shock. Can cause injury or death. If the load equipment will not be ready to accept power on the arrival of the commissioning engineer, ensure that the system output cables are safely isolated at their termination.



WARNING! Risk of electrical shock. Can cause injury or death. When connecting the cables between the battery extremities to the circuit breaker, always connect the circuit breaker end of the cable first.

The rectifier input, bypass, output cables (all require lug-type terminations) are connected to busbars in the I/O sections. The DC power source and battery power cables are connected in the core disconnect cabinet.

The terminal details and connections for your UPS system are described in the installation drawings. Refer to the appropriate illustrations for your unit included herein.

1. For control connection details, See [Control and Communication Cabling](#) below .
2. Close and secure the interior and exterior doors.
3. Attach the kick plates to the bottom of the unit.

NOTE: If the unit will be installed in a position that does not permit access to the rear kick plates, then the kick plates must be installed before the unit is placed in its final position.

4.7 Control and Communication Cabling

NOTE: The low-voltage conduit plate must be removed prior to punching holes for landing conduit. Failure to do so may result in equipment damage due to metal debris.

For control/alarm wiring, use stranded, 16-22AWG cable. Use stranded, 14AWG cable wire up to 500 ft (150 m).

Based on a site's specific needs, the UPS may require auxiliary connections to manage the battery system (external battery circuit breaker), communicate with a building management system or provide alarm signaling to external devices, or for Remote Emergency Power Off (REPO). The connections for the interfaces that follow are in the low-voltage customer connections in front of the UPS I/O section, See **Figure 4.3** on the next page .

Figure 4.3 Customer-Connection Locations in All Models

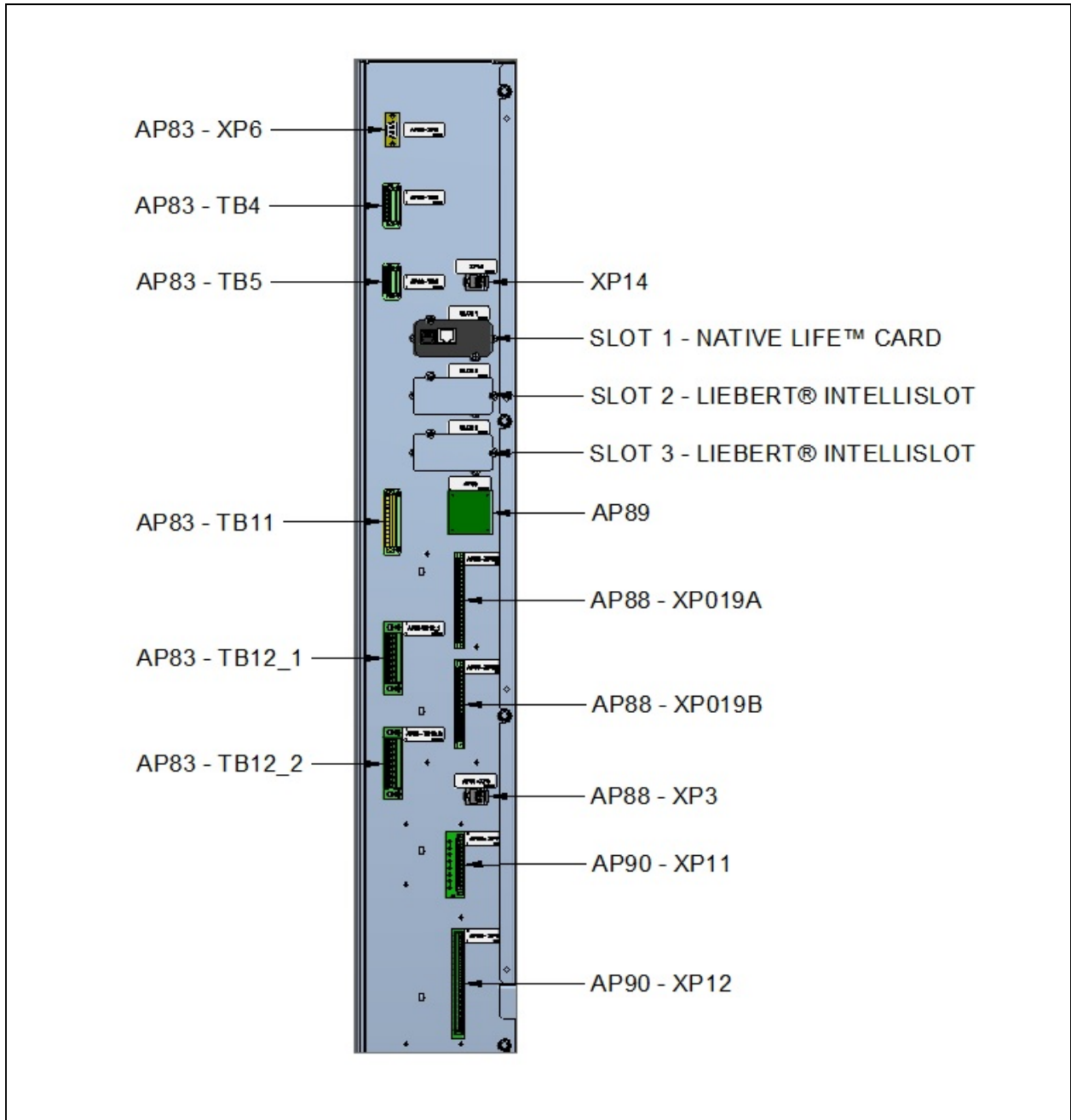

Table 4.1 Connection Interfaces

Slots 1, 2, 3 for Liebert® IntelliSlot Communication Cards.
AP90-XP11 (1-12) Selectable Inputs Dry Contacts (up to 8 Form A/B or 4 Form C Inputs)
AP90-XP12 (1-18) Selectable Outputs Dry Contacts (6 form C outputs)
AP83-TB11 - (1-12) Selectable Inputs Dry Contacts (up to 8 Form A/B or 4 Form C Inputs)
AP83-TB12_1 - (1-9) Selectable Outputs Dry Contacts (6 form C outputs)

Table 4.1 Connection Interfaces (continued)

AP83-TB12_2 - (10-18) Selectable Outputs Dry Contacts (6 form C outputs)
AP83-TB5: (1-2) Remote Alarm Status Power (option)
AP83-TB5: (4-5) Common Battery BIB CAN (option)
AP88 – XP019A (20-Way Male Conn.) Parallel Comms (FBO)
AP88 – XP019B (18-Way Male conn.) Parallel Comms (FBO)
AP88 – XP3 (RJ45) Sync Interface (used for future applications)
AP83 - XP6 (DB9-M) Serial Interface for External LIFE
XP14 Ethernet for Service
AP83 – TB4 (1-4) REPO
AP83 – TB4 (5-7) EPO Status
AP89 – Air Temp I2C

4.7.1 Top-entry Low-voltage Conduit and Cable Routing

NOTE: The low-voltage conduit plate must be removed prior to punching holes for landing conduit. Failure to do so may result in equipment damage due to metal debris.

Remove the low-voltage conduit plate (at the top of the unit and then expose the area by removing the inside cover plate), punch the conduit holes, land the conduit, and then route the control wire to the customer connections.

NOTE: Before making any power wiring connections, make sure that you complete all of the interconnections for your system. The interconnects are very hard to access after the power wiring is complete. To make the interconnections, see connections the appropriate “Interconnection Details” drawing for your system, listed in [Connectivity](#) on page 25 .

4.7.2 Bottom-Entry Low-Voltage Conduit and Cable Routing

Remove the low-voltage conduit plate (at the bottom of the unit and then expose the area by removing the inside cover plate), punch the conduit holes, land the conduit, and then route the control wire to the as See in [Figure 4.4](#) on the next page toward the top of the unit.

NOTE: Before making any power wiring connections, make sure that you complete all of the interconnections for your system. The interconnects are very hard to access after the power wiring is complete. To make the interconnections, see connections the appropriate “Interconnection Details” drawing for your system, listed in [Connectivity](#) on page 25 .

The input/output cabinet See in [Figure 4.4](#) on the next page , is an example of the wiring route. Routing through other cabinets is similar.

Figure 4.4 Low-Voltage Cable Routing Example



Item	Description
1	Front View (doors and panels not shown) Box Mounting Vover Low-Voltage Top
2	Top-Entry Low-Voltage Cable Route
3	Conduit Box NOTE: The low-voltage conduit plate must be removed prior to punching holes for landing conduit. Failure to do so may result in equipment damage due to metal debris.
4	Bottom-Entry Low-Voltage Cable Route

4.7.3 Slots for Liebert® IntelliSlot Cards — SLOT2 and SLOT3

These slots permit installing Liebert® network-communication cards. This adapter provides an independent external network interface for communication with network monitoring and building management systems.

The Liebert® IntelliSlot platform includes the Liebert® IS-UNITY-DP and Liebert® IS-485 EXI cards. The platform communicates with Vertiv™ software tools and services, including Trellis™, Liebert® SiteScan™ Web and Liebert® Nform.

The IS-UNITY-DP card supports up to two third-party protocols along with HTTP/S (Web), Vertiv™ Protocol, SMTP and SMS.

Third-party protocols available on the IS-UNITY-DP card are:

- BACnet IP—BACnet over Internet Protocol
- BBACnet MSTP RS-485
- Modbus RTU
- Modbus TCP
- SNMP versions 1, 2c and 3

When determining the protocols, consider the following:

- No more than two protocols may be enabled on one card.
- Only one version of BACnet may be selected, either BACnet IP or BACnet MSTP.
- Only one version of Modbus may be selected, either Modbus TCP or Modbus RTU.
- Only one of the protocols can use the 485 port; choosing two 485 protocols will cause conflicts.

The IS-485 EXI Card connects to a Liebert® SiteLink-E, allowing Liebert® SiteScan™ Web 4.0 monitoring and control.

4.7.4 Slot for Vertiv™ Liebert® LIFE™ Services Products — SLOT1

This slot is the reserved interface for a Liebert® LIFE™ Services modem card. This card provides an independent external modem interface for communication with Liebert® LIFE™ Services service station. Ask your local Vertiv representative for details on Liebert® LIFE™ Services and its benefits for your UPS system.

4.7.5 Serial Interface for Liebert® LIFE™ Services Cards (Serial Input/Output) — XP6

The service interface is a SUB-D nine-pin male connector for RS-232 serial communication. It is used for communication with external Liebert® LIFE™ Services or other special Liebert® applications.

4.7.6 Connector for REPO (Input and Status) — AP83_TB4

The Remote Emergency Power Off (REPO) shuts down the UPS rectifier, inverter and static bypass. It disconnects the external battery circuit breakers, but it does not disconnect the input mains supply to the UPS. If required, this additional action can be performed by adding an additional contact to the emergency stop switch placed on an upstream breaker.

The REPO button must be connected to the UPS with a twisted/shielded cable no longer than 66 ft. (20 m). The contact must be closed under normal operating conditions. When this contact opens, the load will be cut Off and a fault will appear on the display. Resuming normal operation requires resetting the REPO button to its closed position and resetting the fault on the display.

The UPS REPO status may be monitored by connecting to the Form-C REPO Status Pins 5, 6 and 7.

This four-pole screw connector allows:

- Switching Off the UPS from a remote source (e.g.push button)
- Providing status to an external system regarding whether the REPO is active

To perform a remote emergency power off, it is necessary to connect an emergency stop button to the UPS via a shielded cable not exceeding 66 ft. (20 m) in length. The switch must be “Closed” under normal operating conditions and be equipped with a mechanism that maintains it in the “Open” position after it has been pressed. If this button is not installed, a jumper lead must be connected between Pins 1 and 2. For an indication of REPO status, connect Pin 3 and Pin 4 to an external system.

Table 4.2 REPO Connection

Pin	Signal	Description
1&2	EPO Input Contact #1	EPO is On when input 1 is open. Input 2 is configurable for EPO active open or closed via internal PWA jumper AP83 J4. Pins 1-2/N.C, Pins 3-4/N.O; the inputs are independent and in OR logic
3&4	EPO Input Contact #2	
5	EPO Status Contact - N.C.	Form-C dry contacts rated for 5A @24 VDC

Table 4.2 REPO Connection (continued)

Pin	Signal	Description
6	EPO Status Contact - COMMON	Form-C dry contacts rated for 5A @24 VDC
7	EPO Status Contact - N.O.	

Use stranded 16-22AWG cable.



WARNING! The external push button must be voltage-free and isolated from all sources and GND. The external REPO system must not exceed 24V and 20 mA.

NOTE: The external EPO switch must latch Open when activated.

4.7.7 Customizable Output Dry Contacts — AP90_XP12, AP83-TB12

The UPS has two 18-pin screw connectors (AP90_XP12, AP83-TB12) that allow connecting 12 Form-C or Form-A/B configurable output contacts. Each contact is rated for 120VAC/5A.

Table 4.3 Customizable Output Contacts

To	Form C or Form A/B
AP90: XP12-1	NOT USED
AP90: XP12-2	BFD/RBB BACKFEED PROTECTION TRIP Contact #1 COMMON
AP90: XP12-3	BFD/RBB BACKFEED PROTECTION TRIP Contact #1 N.O.
AP90: XP12-4	SKRU ENABLE CONTACT #2 N.C.
AP90: XP12-5	SKRU ENABLE CONTACT #2 COMMON
AP90: XP12-6	NOT USED
AP90: XP12-7	USER SELECTABLE OUTPUT CONTACT #3 N.C.
AP90: XP12-8	USER SELECTABLE OUTPUT CONTACT #3 COMMON
AP90: XP12-9	USER SELECTABLE OUTPUT CONTACT #3 N.O.
AP90: XP12-10	USER SELECTABLE OUTPUT CONTACT #4 N.C.
AP90: XP12-11	USER SELECTABLE OUTPUT CONTACT #4 COMMON
AP90: XP12-12	USER SELECTABLE OUTPUT CONTACT #4 N.O.
AP90: XP12-13	USER SELECTABLE OUTPUT CONTACT #5 N.C.
AP90: XP12-14	USER SELECTABLE OUTPUT CONTACT #5 COMMON
AP90: XP12-15	USER SELECTABLE OUTPUT CONTACT #5 N.O.
AP90: XP12-16	USER SELECTABLE OUTPUT CONTACT #6 N.C.
AP90: XP12-17	USER SELECTABLE OUTPUT CONTACT #6 COMMON
AP90: XP12-18	USER SELECTABLE OUTPUT CONTACT #6 N.O.
AP83: XP12-1	NOT USED
AP83: XP12-2	INVERTER ON CONTACT #7 COMMON
AP83: XP12-3	INVERTER ON CONTACT #7 N.O.
AP83: XP12-4	NOT USED
AP83: XP12-5	BYPASS ACTIVE CONTACT #8 COMMON
AP83: XP12-6	BYPASS ACTIVE CONTACT #8 N.O.
AP83: XP12-7	NOT USED
AP83: XP12-8	LOAD SUPPLIED BY BATTERY CONTACT #9 COMMON
AP83: XP12-9	LOAD SUPPLIED BY BATTERY CONTACT #9 N.O.
AP83: XP12-10	NOT USED
AP83: XP12-11	RESIDUAL BATTERY AUTONOMY IS EXPIRING CONTACT #10 COMMON
AP83: XP12-12	RESIDUAL BATTERY AUTONOMY IS EXPIRING CONTACT #10 N.O.
AP83: XP12-13	NOT USED
AP83: XP12-14	INVERTER OVERLOAD CONTACT #11 COMMON
AP83: XP12-15	INVERTER OVERLOAD CONTACT #11 N.O.

Table 4.3 Customizable Output Contacts (continued)

To	Form C or Form A/B
AP83: XP12-16	NOT USED
AP83: XP12-17	SUMMARY ALARM CONTACT #12 COMMON
AP83: XP12-18	SUMMARY ALARM CONTACT #12 N.O.

Use stranded 16-22AWG cable. The selectable contacts can be customized (by qualified technicians only) to perform the following functions:

Summary Alarm (Fault/Warning)	Rectifier Mains Failure
Inverter Off	Bypass Mains Failure
Residual Battery Autonomy Is Expiring	Battery Capacity Level 25%
Rectifier or Bypass Mains Failure	Battery Capacity Level 50%
Inverter On	Battery Capacity Level 75
On Battery	Battery Capacity Level 100%
Bypass Active	Load Level 25%
Maintenance Bypass Switch (MBB) Closed	Load Level 50%
Inverter Self-Clocked	Load Level 75%
Summary Fault	Load Level 100%
Inverter Overtemperature	Load Level 105%
Imminent Shutdown	Power Loss Pre-Warning
Battery Undervoltage	Power Loss Warning
Inverter Overload	-

4.7.8 Customizable Input Dry Contacts — AP90-XP11, AP83-TB11 A

The UPS contains two 12-pin screw connectors (AP30-XP11 and AP202-XP11) that allow connecting 8 Form-C or 16 Form-A/B configurable output contacts.

Table 4.4 Customizable Input Contacts

Pin	Form C	Form A/B
AP90: XP11-1	BFD AUX CONTACT #1 N.C.	RBB AUX. CONTACT #1/2 N.O.
AP90: XP11-2	BFD AUX. CONTACT #1 COMMON	RBB AUX. CONTACT/RBB PS OK #1/2 COMMON
AP90: XP11-3	BFD AUX. CONTACT #1 N.O.	RBB PS OK #2 N.O.
AP90: XP11-4	NOT USED	DC GROUND FAULT DET. CONTACT #3 N.O.
AP90: XP11-5	NOT USED	DC GROUND FAULT DET. CONTACT #3/4 COMMON
AP90: XP11-6	NOT USED	USER SELECTABLE INPUT CONTACT #4 N.O.
AP90: XP11-7	NOT USED	MOB AUX. CONTACT #5 N.O.
AP90: XP11-8	NOT USED	MOB AUX. CONTACT #5/6 COMMON
AP90: XP11-9	NOT USED	USER SELECTABLE INPUT CONTACT #6 N.O.
AP90: XP11-10	NOT USED	RFB AUX. CONTACT #7 N.O.
AP90: XP11-11	NOT USED	RFB AUX. CONTACT #7/8 COMMON
AP90: XP11-12	NOT USED	USER SELECTABLE INPUT CONTACT #8 N.O.
AP83: XP11-1	NOT USED	MBB AUX. CONTACT #9 N.O.
AP83: XP11-2	NOT USED	MBB AUX. CONTACT #9/10 COMMON
AP83: XP11-3	NOT USED	USER SELECTABLE INPUT CONTACT #10 N.O.
AP83: XP11-4	NOT USED	MIB AUX. CONTACT #11 N.O.
AP83: XP11-5	NOT USED	MIB AUX. CONTACT #11/12 COMMON
AP83: XP11-6	NOT USED	USER SELECTABLE INPUT CONTACT #12 N.O.
AP83: XP11-7	USER SELECTABLE INPUT CONTACT #7 N.C.	USER SELECTABLE INPUT CONTACT #13 N.O.
AP83: XP11-8	USER SELECTABLE INPUT CONTACT #7 Common	USER SELECTABLE INPUT CONTACT #13/14 Common
AP83: XP11-9	USER SELECTABLE INPUT CONTACT #7 N.O.	USER SELECTABLE INPUT CONTACT #14 N.O.
AP83: XP11-10	SKRU STATUS CONTACT #8 N.C.	NOT USED
AP83: XP11-11	SKRU STATUS CONTACT #8 COMMON	NOT USED
AP83: XP11-12	SKRU STATUS CONTACT #8 N.O.	NOT USED

Use stranded 16-22AWG cable. The selectable input contacts can be customized by qualified service technicians to perform the functions below.



WARNING! Use no-voltage contacts to drive the inputs. Do not use voltages supplied by an external power supply.

- On Generator
- Mirrored on Generator
- Fast Power Off
- External Maintenance Bypass CB
- Fault Acknowledge
- External Output CB (MOB)
- Maintenance Isolation Breaker (MIB)
- Disable Inverter Start
- Force Rectifier Off/On
- DC Ground Fault Detection
- Disable Bypass SS
- Disable Battery Charging
- External Remote Feed CB Status
- External Remote Back-Feed CB Status
- External Load Bank CB Status System
- External Load Bank CB Status Module
- Remote Enable
- Remote Transfer to Bypass
- Remote Transfer to Inverter

Remote Control Using Programmable Logic Controllers (PLC)

The UPS provides an external control interface for maintenance bypass switchgear equipped with a key interlock system and to manage a battery system. The interface provides (8) form C or (16) selectable form A/B programmable input dry contacts, and (12) form C output dry contacts that can also be configured as form A/B programmable output dry contacts. Programmable contacts can be customized to meet customer needs and to integrate with remote controls.

Figure 4.5 on the facing page illustrates the location of each breaker for a typical UPS system, and **Table 4.5** on the facing page describes available programmable input contacts for external circuit breakers.

While the programmable contacts allow flexibility for integration with external controls, it is important to note that any UPS input contact programmed to reflect the status of a breaker must be supplied by an auxiliary contact of that breaker. The status of a breaker should not be supplied to the UPS input contacts by PLC logic-driven output contacts.

Each UPS input contact can be programmed to reflect the state of a single breaker only and should not receive multiple breaker status signals (that is, no piggybacking signals). Failure to adhere to these guidelines may result in unintended operation, damage to the equipment, or even a critical load loss. Any customers planning Trinergy™ Cube installations that incorporate PLC remote control should contact Vertiv Applications Engineering for guidance.

Figure 4.5 External Circuit Breakers in a Typical System

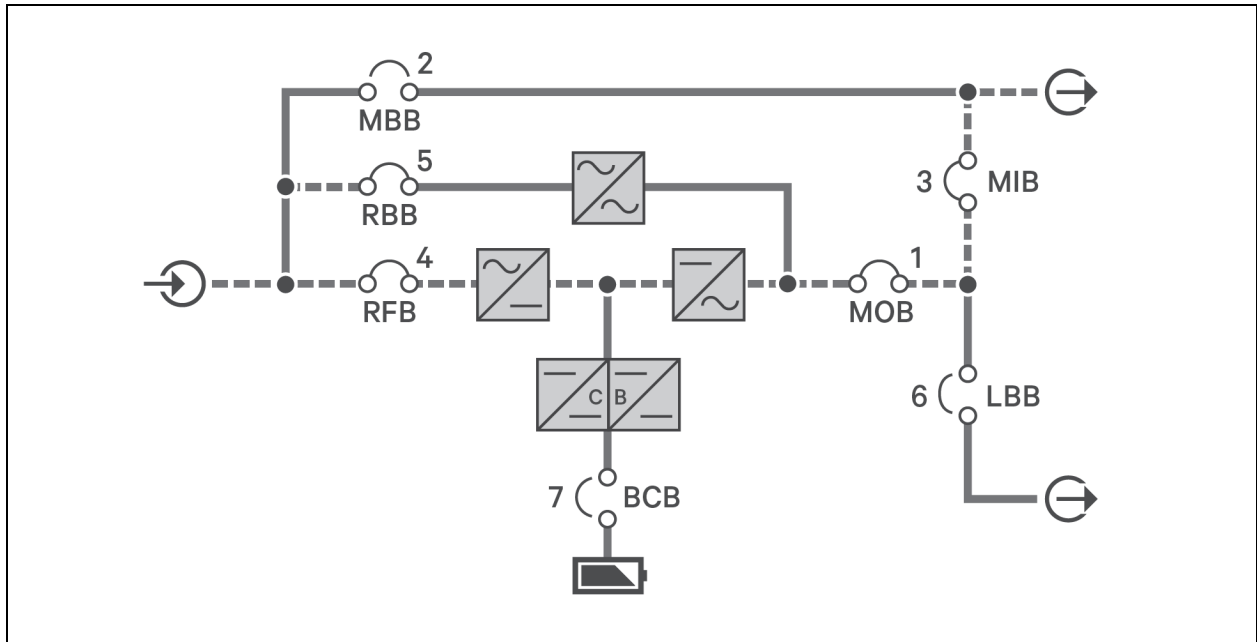

Table 4.5 Programmable Input Contacts for External Circuit Breakers

Item	Signal	Description
1	Module Output Breaker (MOB)	The MOB isolates the output of the UPS from the critical load or collective bus of a parallel UPS system. It is typically located in a system paralleling cabinet, system control cabinet, switchgear, or switchboard.
2	Maintenance Bypass Breaker (MBB)	The MBB isolates an alternate source from the critical load. It is typically located in a maintenance bypass cabinet, system paralleling cabinet, system control cabinet, switchgear, switchboard, or panel board.
3	Maintenance Isolation Breaker (MIB)	The MIB isolates the UPS system from the critical load. It is typically located in a maintenance bypass cabinet, system paralleling cabinet, system control cabinet, switchgear, switchboard, or panel board.
4	Rectifier Feed Breaker (RFB)	The RFB isolates the UPS rectifier input. It is typically located in switchgear, a switchboard, or a panel board.
5	Remote Back-feed Breaker (RBB)	The RBB isolates the UPS static bypass switch input. It is typically located in switchgear, a switchboard, or a panel board.
6	Load Bank Breaker (LBB)	The LBB connects the output of the UPS or the critical load to a load bank for testing. It is typically located in switchgear, a switchboard, or a panel board.
7	Battery Circuit Breaker (BCB)	The BCB isolates the DC/DC converter of the UPS from the battery system. The BCB is typically co-located with the battery system.

4.7.9 Connector for Parallel UPS Connection — AP88-XP019A, AP88-XP019B

This interface is used for paralleling two or more UPSs with each other.

4.7.10 UPS Control Contacts with Battery Cabinet or Module Battery Disconnect

These contacts are used to communicate between the UPS module and Battery cabinets or Module Battery Disconnects.

Table 4.6 Battery Control Interface

Terminal Block	Pin	Connects to (Description of External Item)
AP30-TB5	1	CAN +24 V - Battery Interface Board TB1154-1
	2	Ground - Battery Interface Board TB1154-2
	4	CANbus High - Battery Interface Board TB1154-3
	5	CANbus Low - Battery Interface Board TB1154-4

Use Belden 9156 equivalent wire. Total length of cable from the UPS to all battery interface connections must be less than 1000 ft. (300 m).

4.7.11 UPS Control Contacts with Global Maintenance Bypass

These contacts are used to communicate between the UPS module and Maintenance Bypass.

Table 4.7 Maintenance Bypass Key Status

Terminal Block	Pin	Description
AP90:XP11	10	Key status switch, closed = key inserted
	11	Key status switch, common
	12	Key status switch, closed = key removed
<ol style="list-style-type: none"> See Distributed Static Switch (1+N) System Cabling Layouts below for 1+N systems with a Maintenance Bypass. Key Status Input must be Form-C contact. 		

For control/alarm wiring, use stranded 16-22AWG cable. Use stranded 14-AWG cable wire up to 500 ft. (150 m).

Table 4.8 Maintenance Bypass SKRU Enable

Terminal Block	Pin	Description
AP90:XP12	4	Maintenance Bypass Cabinet, closed = load not on inverter
	5	Maintenance Bypass Cabinet, common
<ol style="list-style-type: none"> For 1+N systems with a maintenance bypass, these contacts must be run to each module from an isolated source. These contacts must be run separately from all other control cables. 		

4.8 Distributed Static Switch (1+N) System Cabling Layouts

The output switchboard must be fitted with module output breakers (MOB) equipped with auxiliary contacts to communicate breaker status. The MOB must function properly with current levels that may occur when switching a module onto the active bus. Breakers with adjustable instantaneous settings should be adequate to achieve this.

NOTE: Before making any power wiring connections, make sure that you complete all of the interconnections for your system. The interconnects are very hard to access after the power wiring is complete. To make the interconnections, see connections the appropriate “Interconnection Details” drawing for your system, listed in [Connectivity](#) on page 25 .

The distributed static-switch cabling for your UPS system is described in the installation drawings. Refer to the appropriate illustrations for your unit included herein.

The following table lists the drawings by number, UPS model and options.

Table 4.9 System Cabling Layout Drawings

Drawing Number	Model/Options
Single Module, Single-Input Layouts	
ES1-01-S001	with static bypass
ES1-01-S002	with static bypass and back-feed disconnect
ES1-01-S003	with static bypass and two-breaker external maintenance bypass
ES1-01-S004	with static bypass, two-breaker external maintenance bypass, and back-feed breaker
ES1-01-S005	with single input, static bypass, and three-breaker external maintenance bypass
ES1-01-S006	with static bypass, three-breaker external maintenance bypass, and back-feed disconnect
Single Module, Dual-Input Layouts	
ES1-01-S007	with static bypass
ES1-01-S008	with static bypass and back-feed disconnect
ES1-01-S009	with static bypass and two-breaker external maintenance bypass
ES1-01-S010	with static bypass, two-breaker external maintenance bypass, and back-feed disconnect
ES1-01-S011	with static bypass and three-breaker external maintenance bypass
ES1-01-S012	with static bypass and four-breaker external maintenance bypass
1+N Multi-Module, Single-Input Layouts	
ES1-02-S001	with static bypass and two-breaker paralleling cabinet
ES1-02-S002	with static bypass, two-breaker paralleling cabinet, and back-feed disconnect
ES1-02-S005	without static bypass

Table 4.9 System Cabling Layout Drawings (continued)

Drawing Number	Model/Options
1+N Multi-module, Dual-Input Layouts	
ES1-02-S003	with static bypass and two-breaker paralleling cabinet
ES1-02-S004	with static bypass, two-breaker paralleling cabinet, and back-feed disconnect
Control Cabling Layouts	
ES1-19-S002	Communications and general contacts
ES1-19-S003	DC source cable layout - UPS with matching battery cabinets
ES1-19-S004	DC source cable layout - UPS with third-party battery cabinets
ES1-19-S005	DC source cable layout - UPS with third-party maintenance-bypass-distribution and battery cabinets
ES1-19-S007	Maintenance bypass cabinet with single module
ES1-19-S024	System controls, distributed static switch (1+N) multi-module and paralleling cabinet

4.9 Electrical Connections to I/O Box to Cores

The connections must be performed by properly trained and qualified personnel.

Arrangement of the modules inside the unit is shown below.

Figure 4.6 Core, Front, Module Locations

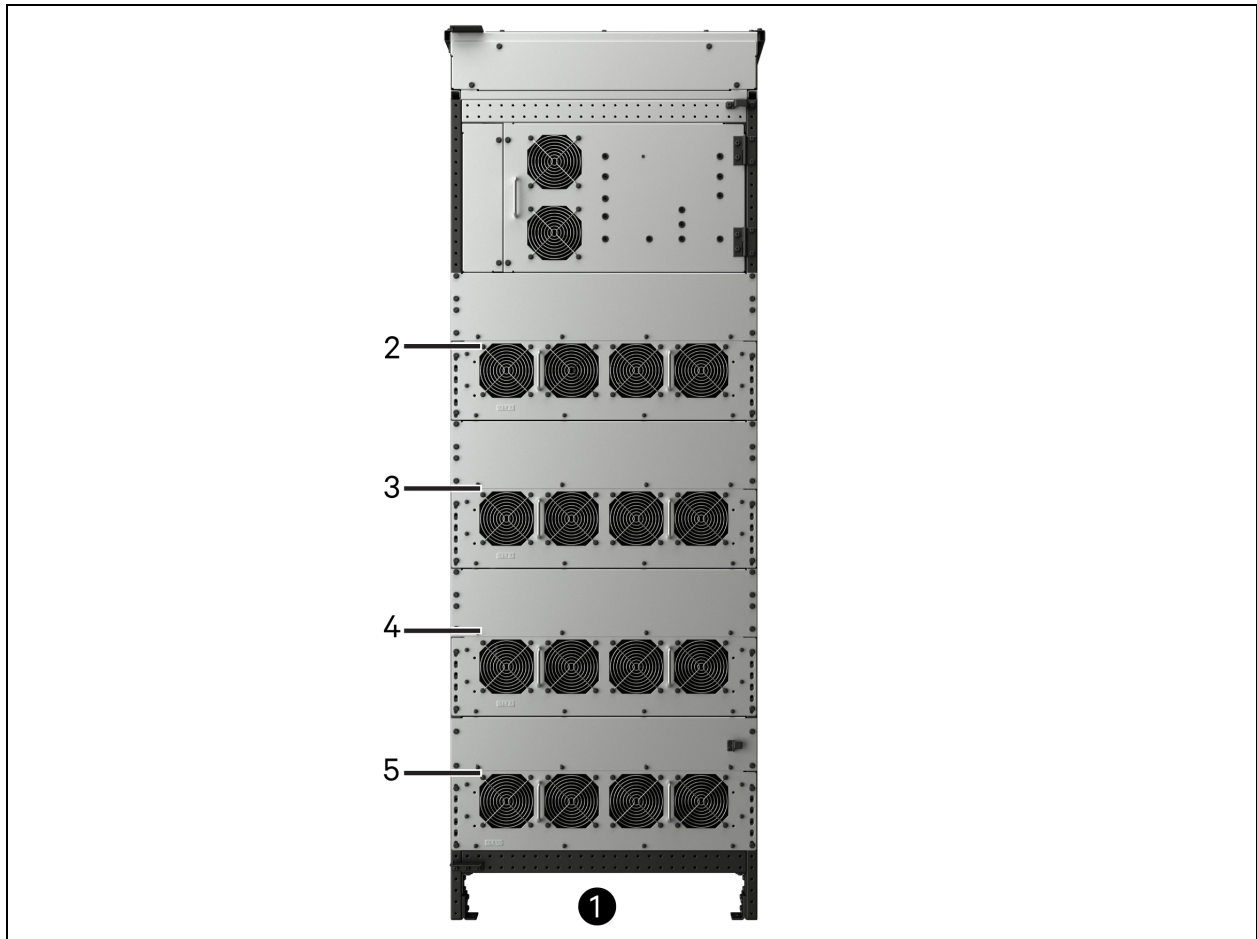

Item	Description
1	400kVA Core
2	Rectifier/Inverter Module, Phase A
3	Rectifier/Inverter Module, Phase B
4	Rectifier/Inverter Module, Phase C
5	Boost Module

Figure 4.7 Parts to Remove to Perform Electrical Power Connections

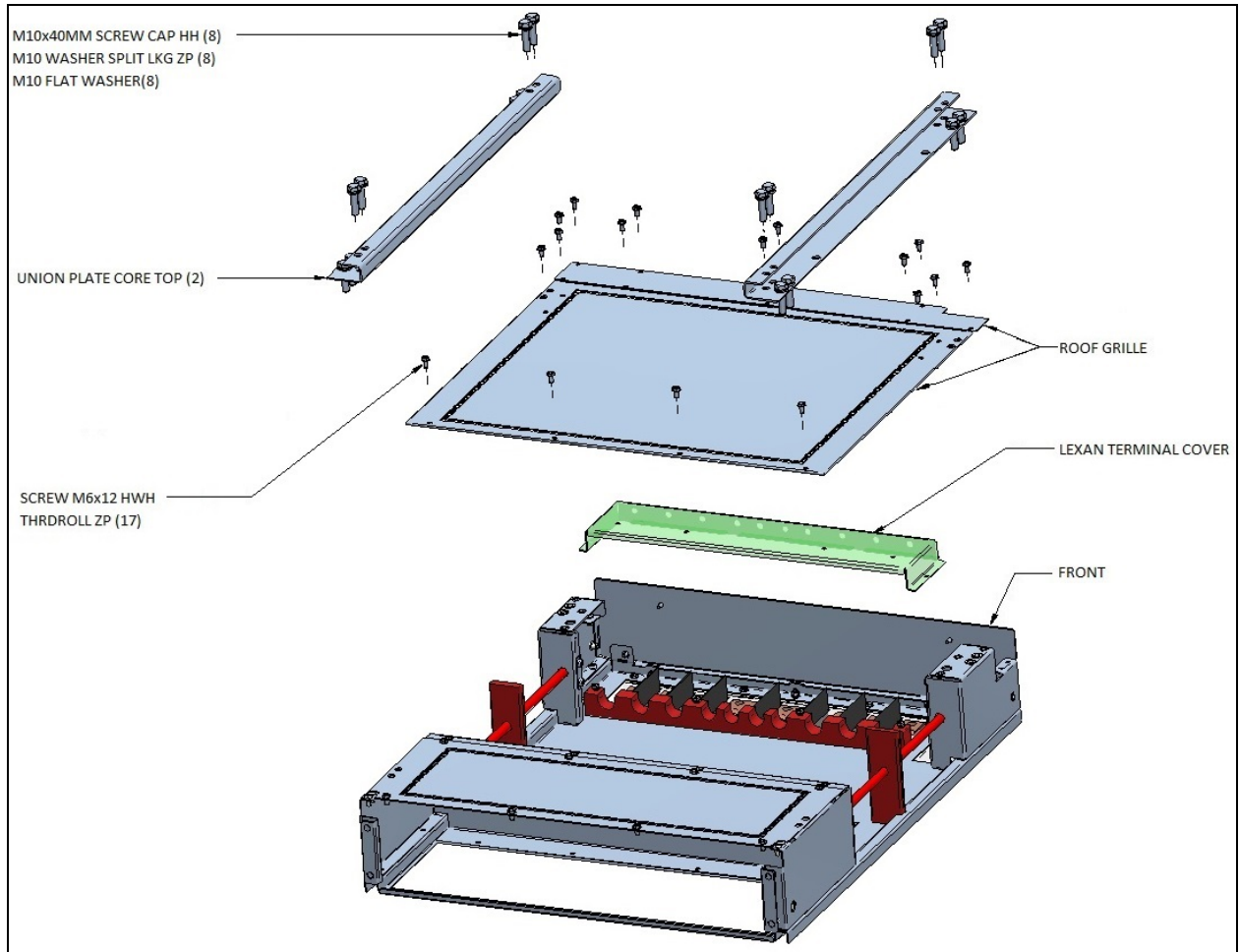

Figure 4.8 Connections Between the I/O Box and Cores, Right Side, Top View

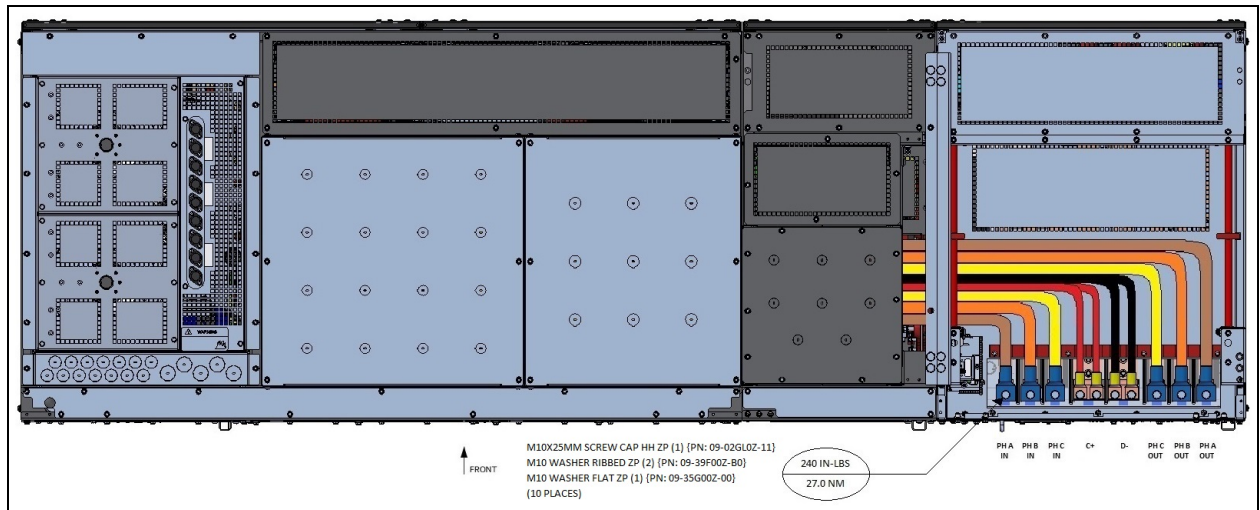

Figure 4.9 I/O Box, Right-Side Connection to the Core, Front View

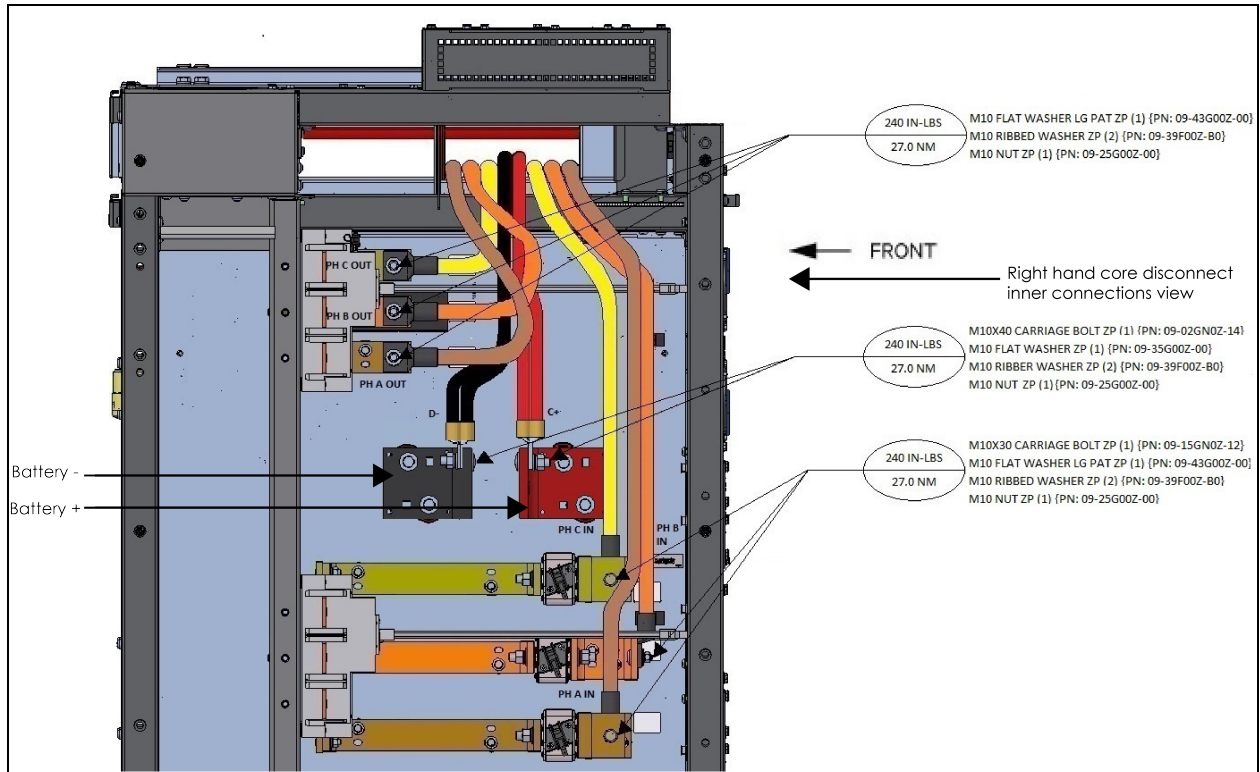

Figure 4.10 I/O Box Up to Two Cores in the Row, Electrical Connections

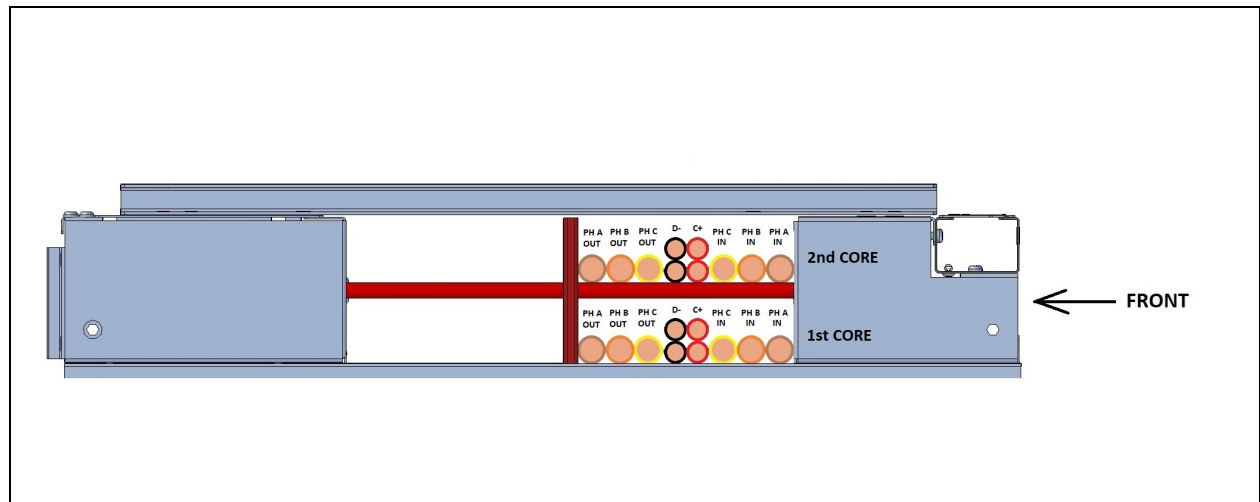

Figure 4.11 I/O Box Up to Four Cores in the Row - Electrical Connections

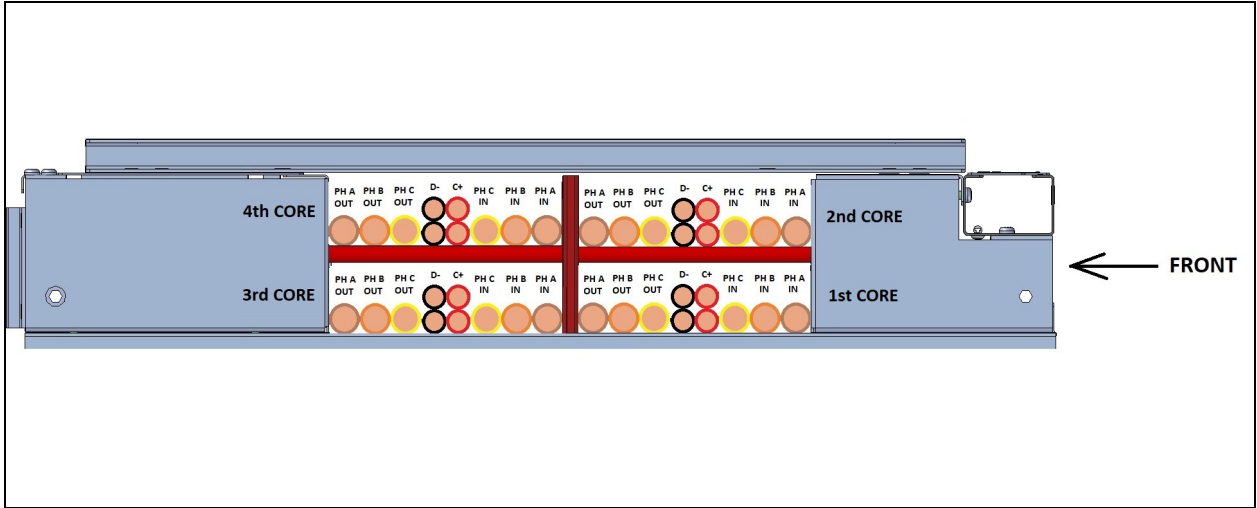

Figure 4.12 Connections between I/O Box and Cores, Left Side, Top View

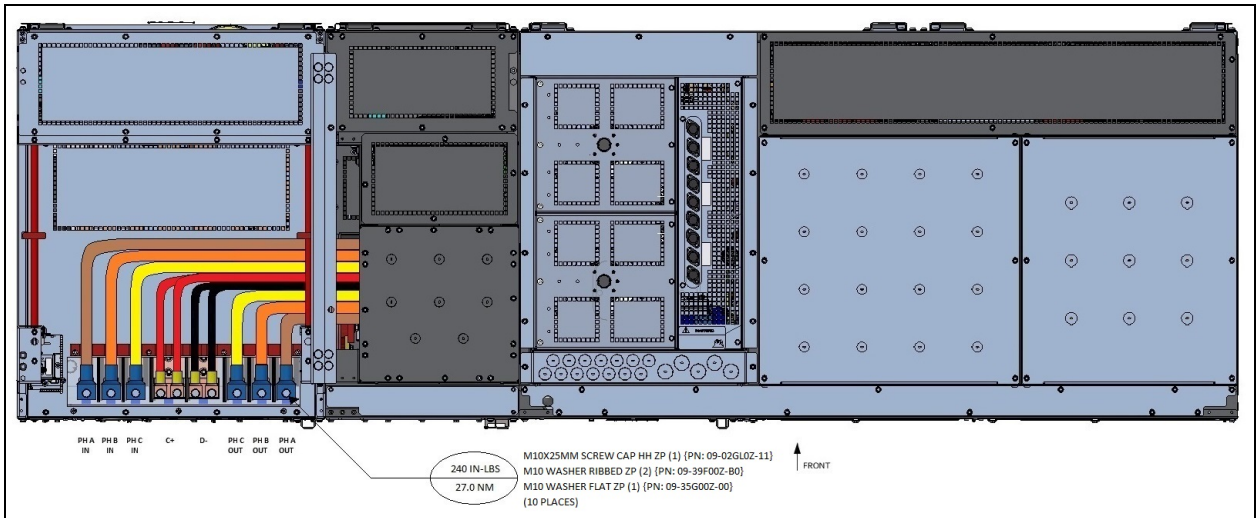

Figure 4.13 I/O Box - Left-Side Connection to the Core

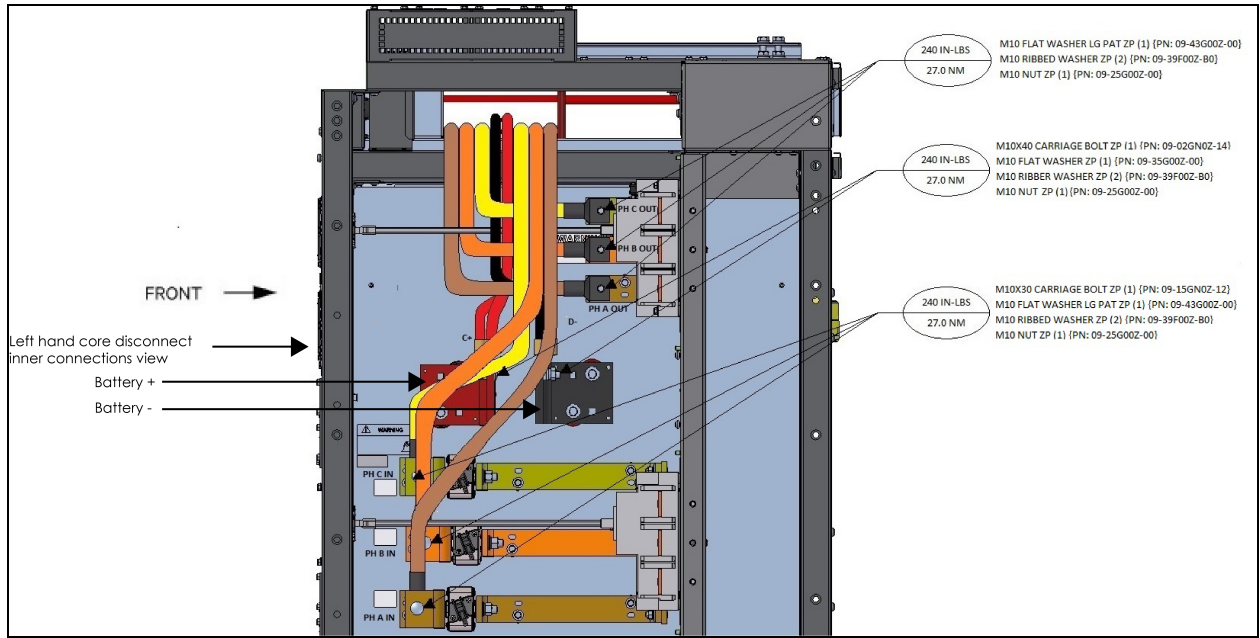

Figure 4.14 I/O Box Up to Two Cores in the Row - Electrical Connections

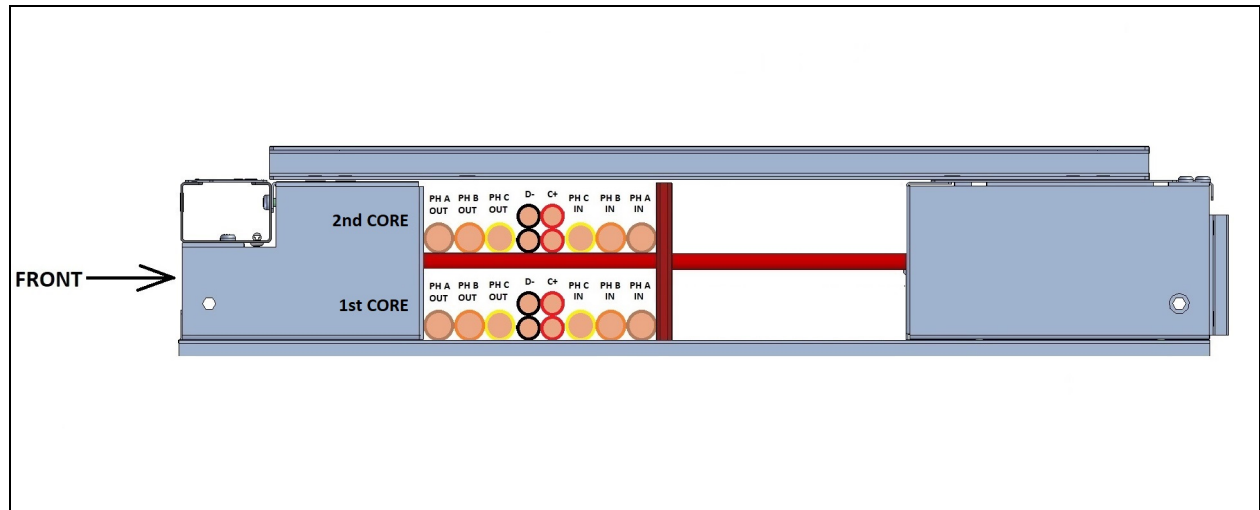
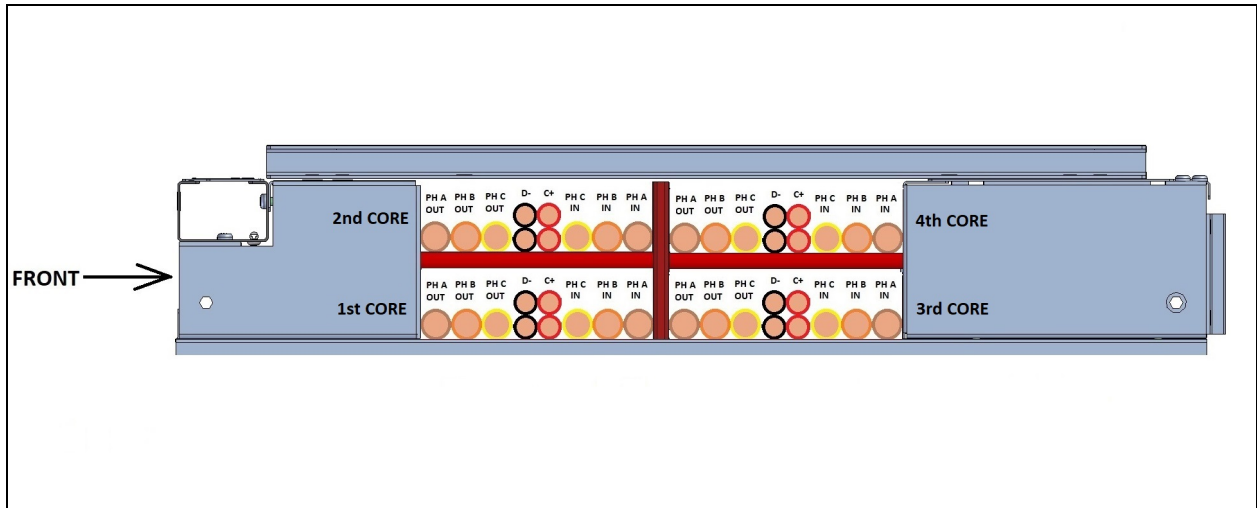

Figure 4.15 I/O Box Up to Four Cores in the Row - Electrical Connections



5 Optional Equipment

5.1 Factory-Installed Options

5.1.1 Single-Input Jumpers

Enables the UPS rectifier and bypass inputs to be fed from a single 3-phase AC source.

5.1.2 Liebert® IntelliSlot Unity-DP Card

Provides network connectivity for two protocols (options include SNMP, Modbus, BACnet, YDN23).

5.1.3 Liebert® IntelliSlot 485 Card

Provides a communication interface from Liebert devices to a Building Management System or Liebert® SiteScan™ SiteLink modules for remote monitoring and control via Modbus RTU or Vertiv proprietary protocol.

5.1.4 DC Battery Ground Fault Detection

Enables the detection and annunciation of battery DC ground faults in order to facilitate proactive resolution of such ground faults for 2014 NEC compliance.

5.1.5 Emergency Power Off

Allows shutdown of the UPS from the user controls. This provides a local method to turn Off the UPS power conversion and bypass. Connection for a user-provided remote EPO signal is standard.

5.1.6 FCC Compliance Filter Compatibility

Ensures compliance with FCC Part 15, Class A where required.

5.2 Field-Installed Options

5.2.1 Remote Alarm Status Panel (RAS)

Includes audible alarm, reset, enable and lamp test controls as well as LED indicators for system status. RAS is available in either flush-mount or surface-mount. Specify mounting on order form.

5.2.2 Battery Interface Box

The Battery Interface Box contains a Battery Interface Board. The Battery Interface Box is required when a UPS module is installed with any non-Liebert battery cabinet, non-matching MBD or Battery Isolation Switch (BIS). One Battery Interface Box is required for each MBD or BIS. Liebert battery cabinets incorporate Battery Interface Boards and do not require a separate Battery Interface Box.

5.2.3 Temperature Sensor

This sensor is needed only for battery solutions utilizing a non-Liebert battery cabinet, non-matching MBD or BIS. Liebert battery packs have built-in temperature sensors. The Temperature Sensor option includes a remote sensor that must be field-installed.

5.2.4 Seismic Anchoring Kit

The Seismic Anchoring Kit includes the rails and brackets to provide seismic restraint for the module as described in Section 13.2.1.2 of ASCE/SEI 7-05. Based on structural analysis by a design professional, the anchoring hardware provides a solution in compliance with the International Building Code (IBC) 2021.

5.3 Rectifier Feed Breaker (RFB)

For systems that use a Rectifier Feed Breaker (RFB), the controls for the Aux contact and UVR/shunt trip will go between the remote breaker and the UPS I/O and Customer Connectivity sections. Power for the UVR/shunt trip is customer-supplied.

Table 5.1 Rectifier Feed Breaker specifications

Power Class	kAIC Rating	RFB Specification	RFB General Specification	Comments
400-1600kVA	100 kA Module	UL-Listed 489 (Molded Case Circuit Breaker) or UL 1066 (Low Voltage AC Power Circuit Breaker), which are required for use in UL-listed switchgear or switchboards. The circuit breaker must have a short-time rating of 100 kA at a maximum voltage of 480V for three cycles.	The remote breaker must be equipped with auxiliary contacts for proper operation with the UPS.	UPS internal fuse protection exists on rectifier and bypass input.

5.4 Multi-Module System Options and Accessories

The accessories and options for single-module systems may be applied to the individual modules in a multi-module (1+N) system or a synchronized dual-bus (2N) system.

6 Specifications

Table 6.1 Vertiv™ Liebert® Trinergy™ Cube Specifications and Standards

Parameters	Specification
UPS Rating at 95°F (35°C), kVA	400 - 1600
UPS Rating at 104°F (40°C), kVA	375 - 1500
Output Active Power at 95°F (35°C), kW	400 - 1600
Output Active Power at 104°F (40°C), kW	375 - 1500
Input AC Parameters	
Input Voltage to Rectifier/Bypass, VAC	480, 3-Phase, 3-Wire
Permissible Input Voltage Range	+10%, -10%
Input Frequency, Hz	60± 5
Input Power Factor	≥ 0.99
Input Current Distortion (THDI) at Nominal Voltage at Full Load, %	≤ 3.0
Power Walk-In (seconds)	1 to 90 (Selectable in 1 Second Increments)
Internal Back-Feed Protection	Yes
Input Connection	Single or dual feed
Short-Circuit Withstand Rating (kA)	100
Battery and DC Parameters	
Battery Type	Vertiv HPL, Lithium ion, VRLA (Valve Regulated Lead Acid), VLA (Vented Lead Acid)
Nominal Battery Bus, VDC / Battery Float Voltage, VDC	480 / 540, 576 max
DC Ripple at Float Voltage	< 1.0% (RMS value) < 3.4% Vpp
Temperature Compensated Battery Charging	Standard with Vertiv™ VRLA Battery Cabinets
Output Parameters	
Load Power Factor Supported (Without Derating)	0.7 Leading to 0.4 Lagging
Output Voltage, VAC	480, 3-Phase, 3-Wire
Output Voltage Regulation (%) / Output Voltage Regulation (50% Unbalanced Load) (%)	< 1.0 (3-phase RMS average) / < 2.0 (3-phase RMS average)
Output Frequency, Hz	60 ± 0.1%
Output THD at Nominal Voltage (Linear Load), %	≤ 1.5 (RMS Value)
Output THD at Nominal Voltage Including a 100kVA Non-Linear Load per IEC 62040-3, %	≤ 5.0 (RMS Value)
Transient Recovery 100% Load Step / 50% Load Step / Loss of/Return to AC Input Power	±4% / ±2% / ±2% (RMS average for one cycle)
Voltage Displacement (Balance Loads) / Voltage Displacement (50% Balance Loads)	120 deg ±1 deg / 120 deg ±2 deg

Table 6.1 Vertiv™ Liebert® Trinergy™ Cube Specifications and Standards (continued)

Parameters	Specification
Overload at Nominal Voltage and 77°F (25°C)	110% continuously; 125% for 10 minutes; 150% for 60 seconds; 200% for 200 milliseconds
Overload in Bypass Operation at 104°F (40°C)	110% continuously; 125% for 10 minutes; 150% for 60 seconds; 700% for 600 milliseconds; 1000% for 100 milliseconds
Efficiency	
Double-Conversion Mode	Up to 96.8%
ECO Mode	Up to 99.2%
Physical Characteristics	
Dimensions for Core, 400kW, W x D x H In. (mm)	26.8 x 36.1 x 77.0 (681 x 917 x 1956)
Dimensions for Core Disconnect (connects up to two Cores to I/O Box), W x D x H In. (mm)	16.8 x 36.1 x 80.3 (427 x 917 x 2040)
Dimensions for I/O Box 2400A, W x D x H, in. (mm)	62.2 x 36.1 x 80.3 (1580 x 917 x 2040)
Weight for Core 400 kW, lb (kg)	1300 (590)
Dimensions for I/O + CD x 1, W x D x H In.(mm)	79 x 36.1 x 80.3 (2007 x 917 x 2040)
Dimensions for I/O + CD x 2, W x D x H In.(mm)	95.8 x 36.1 x 80.3 (2434 x 917 x 2040)
Dimensions for I/O + CD x 3, W x D x H In.(mm)	112.6 x 36.1 x 80.3 (2861 x 917 x 2040)
Dimensions for I/O + Core Disconnect Shipping Pallet, W x D x H In.(mm)	126 x 42 x 5.01 (1302.2 x 1066.8 x 127.3)
Dimensions for palletized I/O + 1, 2, or 3, Core Disconnect Cabinets, W x D x H In. (mm)	126 x 42 x 85.31 (1302.2 x 1066.8 x 2167.3)
Weight for Core Disconnect (connects up to two Cores to I/O Box), lb. (kg)	435 (198)
Weight for I/O Box 2400A, lb. (kg)	2050 (930)
Color	Black, RAL 7021
Protection Class, UPS Enclosure	NEMA 1, IP 20 (with and without front door open)
Environmental	
Operating Temperature	32°F to 131°F* (0°C to 55°C*)
Relative Humidity	0% to 95%, non-condensing
Operating Altitude, ft. (m)	Up to 3300 (1000) without derating
Heat Dissipation at Full Load in VFI (BTU/h)	52440 (400 kW per Core)
Airflow at Full Load in VFI (CFM)	up to 3225 (per 400 kW Core)
Storage Temperature Range	-4°F to 104°F (-20°C to 40°C)
Storage Humidity	95% or less Non-Condensing
Paralleling	Up to 5 cores (4 cores for capacity and 1 core for redundancy) in one unit, up to 8 units in parallel
Hot Swappable core	Yes
Acoustical Noise, dBA	78 (72 at partial load)

Table 6.1 Vertiv™ Liebert® Trinergy™ Cube Specifications and Standards (continued)

Parameters	Specification
Communications	
Control panel	Multifunction 12-inch Color Touchscreen
Options	2 Liebert® IntelliSlot
Card Compatibility	IS-UNITY-DP, IS-485EXI
Protocols	BACnet IP, BACnet MSTP, Modbus TCP, Modbus RTU, SNMP, YDN23, LIFE™ Services
Inputs/Outputs	8/12 Programmable (Form C)
Standards	
Transportation / Safety	ISTA Procedure 3B / UL 1778 5th Edition; CSA 222 NO 107.3
EMI / Surge	IEC 62040-2; FCC Part 15, Class A / ANSI C62.41, Category B3
UL9540 Trinergy Cube PHR3462 to be used with Samsung Battery Cabinet PHR3462 Trinergy Cube PHR3462 to be used with Samsung Battery Cabinet PHR3262 Trinergy Cube PHR3462 to be used with Samsung Battery Cabinet PHR2852 Trinergy Cube PHR3462 to be used with Samsung Battery Cabinet PHR2652 Trinergy Cube PHR3462 to be used with Samsung Battery Cabinet PHR2042	If installing per UL9540 Compliance between Trinergy Cube UPS and Samsung ESS; the Samsung ESS has been Fire Propagation Tested in accordance with UL9540A, Project Number: 4789212736.
Maximum Rated Energy Capacity (Trinergy Cube + Samsung ESS)	34.6 kWh Per Battery Cabinet (Maximum of 2 Battery Cabinets per UPS Core, Maximum of 8 Battery Cabinets Total)
Minimum Distance Between UPS Systems	20 mm from battery room walls
UL9540 Seismic Rating	If installing per UL9540 Compliance between Trinergy Cube UPS and Samsung ESS; Samsung ESS complies with CBC 2019, and IBC 2018. Trinergy Cube UPS complies with IBC 2021.
	Energy Storage System (ESS) is not intended for installation in locations subjected to seismic activity since this system has not been subjected to seismic testing.
	Samsung ESS: SDS = 1.70, Z/H = 1.0; Trinergy Cube UPS: SDS = 1.20, Z/H = 1.0
	SDS = 2.15, Z/H = 0; SDS = 1.61, Z/H = 0
	Ip = 1.5; Ip = 1.5
General and System Data	
Inverter Type	High-Efficiency, Transformer-Free IGBT, Three-Level PWM Inverter
Rectifier Type	High-Efficiency, Transformer-Free IGBT, Three-Level PWM Inverter
Parallel Configuration	Up to 8 units in parallel
Access	Front and Top (no rear access required)
*Conditions apply	

Table 6.2 Overload

77°F (25°C)		86°F (30°C)		95°F (35°C)		104°F (40°C)	
Time sec.	Load %	Time sec.	Load %	Time sec.	Load %	Time sec.	Load %
0.2	200	0.2	200	0.2	200	0.2	200
1	158	1	158	1	158	1	158
28	155	30	155	15	155	19	155
50	152	47	152	30	152	28	152
330	130	155	130	90	130	40	130
600	125	210	125	115	125	47	125
—	110	—	110	207	110	77	102

Based on nominal input voltage and no battery charging.

Table 6.3 Overload Capacity - Current vs Time

% Load	Overload Time, sec.
110	750
125	300
130	210
152	19
155	5.45
158	5.17
165	0.61

Based on normal input voltage

UPS Current Ratings

Table 6.4 Rectifier Input (Full System 4 Cores)

UPS Rating					
Tamb(°C)	kVA	kW	Voltage (Vac)	Nominal current	Maximum Current
35°C	1600	1600	480	1998	2220
40°C	1480	1400	480	1752	1940
45°C	1160	1160	480	1452	1620
50°C	1100	1100	480	1377	1540
55°C	1000	1000	480	1252	1400

Table 6.5 Bypass

UPS Rating				
Tamb (°C)	kVA	kW	Voltage (Vac)	Nominal Current
35°C	1600	1600	480	1925
40°C	1480	1400	480	1780
45°C	1160	1160	480	1395
50°C	1100	1100	480	1323
55°C	1000	1000	480	1203

Table 6.6 Output

UPS Rating				
UPS Rating				
Tamb (°C)	kVA	kW	Voltage (Vac)	Nominal Current
35°C	1600	1600	480	1925
40°C	1480	1400	480	1780
45°C	1160	1160	480	1395
50°C	1100	1100	480	1323
55°C	1000	1000	480	1203

Table 6.7 Battery

UPS Rating (Core)				
Tamb (°C)	kVA	kW	Nominal, VDC	Nominal Current
35°C	1600	1600	540	1004
40°C	1480	1400	540	883
45°C	1160	1160	540	728
50°C	1100	1100	540	690
55°C	1000	1000	540	628

Notes on Tables:

1. Maximum current includes nominal input current and maximum battery recharge current (considered non-continuous). Continuous and non-continuous current limits are defined in NEC 100. Values shown for maximum current are 110% of nominal input current, except for 1200 kVA/kW module with 1600 A breaker. This 1200 kVA/kW module has a maximum current of 105% of nominal input current. Contact Applications Engineering for support in configuring a 1200 kVA/kW module with a 1600 A external rectifier input breaker.
2. For breaker coordination while the module is overloaded, see the current-versus-time values on the overload curves.
3. Nominal battery voltage is shown at 2.0 volts/cell.
4. Maximum battery current at end of discharge level of 1.67 volts per cell (240 cells).
5. Nominal AC output current (considered continuous) is based on full rated output load.

6. Bypass AC input current (considered continuous) is based on the full-rated output load.

Table 6.8 Current-Versus-Time Curves of Inverter Overload Capacity

Ambient Temperature							
Time, sec.	77°F (25°C)	Time, sec.	86°F (30°C)	Time, sec.	95°F (35°C)	Time, sec.	104°F (40°C)
	Load %		Load %		Load %		Load %
0.2	200%	0.2	200%	0.2	200%	0.2	200%
1	158%	1	158%	1	158%	1	158%
28	155%	30	155%	15	155%	19	155%
50	152%	47	152%	30	152%	28	152%
330	130%	155	130%	90	130%	40	130%
600	125%	210	125%	115	125%	47	125%
—	110%	—	110%	207	110%	77	102%

Based on nominal input voltage and no battery charging.

Table 6.9 Current-Versus-Time Curves of Bypass Overload Capacity, 104° (40°C)

% Load	Overload Time, sec.
110	750
125	300
130	210
152	19
155	5.45
158	5.17
165	0.61

Based on nominal input voltage

Table 6.10 Recommended Conduit and Cable Sizes

UPS Rating		Voltage (VAC)	Cable Entry	(# of conduits); size of conduits; # -size of phase cables per conduit; size of cable for ground per conduit	
kVA	kW			Copper Conductors	Aluminum Conductors
RECTIFIER INPUT					
400	400	480	Top	2 - 2.5" (350 kcmil/ph+1 awg gnd)	2 - 3" (500 kcmil/ph+2/0 awg gnd)
			Bottom	2 - 3" (350 kcmil/ph+1 awg gnd)	2 - 3.5" (500 kcmil/ph+2/0 awg gnd)
500	500	480	Top	3 - 2.5" (250 kcmil/ph+1/0 AWG Gnd)	3 - 2.5" (350 kcmil/ph+3/0 awg gnd)
			Bottom	3 - 2.5" (250 kcmil/ph+1/0 awg gnd)	3 - 3" (350 kcmil/ph+3/0 awg gnd)
600	600	480	Top	3 - 2.5" (350 kcmil/ph+2/0 awg gnd)	3 - 3" (500 kcmil/ph+4/0 awg gnd)
			Bottom	3 - 3" (350 kcmil/ph+2/0 AWG Gnd)	3 - 3.5" (500 kcmil/ph+4/0 AWG Gnd)

Table 6.10 Recommended Conduit and Cable Sizes (continued)

UPS Rating		Voltage (VAC)	Cable Entry	(# of conduits); size of conduits; # -size of phase cables per conduit; size of cable for ground per conduit	
kVA	kW			Copper Conductors	Aluminum Conductors
625	625	480	Top	3 - 2.5" (350 kcmil/ph+2/0 AWG Gnd)	3 - 3" (500 kcmil/ph+4/0 AWG Gnd)
			Bottom	3 - 3" (350 kcmil/ph+2/0 AWG Gnd)	3 - 3.5" (500 kcmil/ph+4/0 AWG Gnd)
750	750	480	Top	4 - 2.5" (350 kcmil/ph+3/0 AWG Gnd)	4 - 3" (500 kcmil/ph+250 kcmil Gnd)
			Bottom	4 - 3" (350 kcmil/ph+3/0 AWG Gnd)	4 - 3.5" (500 kcmil/ph+250 kcmil Gnd)
800	800	480	Top	4 - 2.5" (350 kcmil/ph+3/0 AWG Gnd)	4 - 3" (500 kcmil/ph+250 kcmil Gnd)
			Bottom	4 - 3" (350 kcmil/ph+3/0 AWG Gnd)	4 - 3.5" (500 kcmil/ph+250 kcmil Gnd)
1000	1000	480	Top	4 - 3" (500 kcmil/ph+4/0 AWG Gnd)	5 - 3" (500 kcmil/ph+350 kcmil Gnd)
			Bottom	4 - 3.5" (500 kcmil/ph+4/0 AWG Gnd)	5 - 3.5" (500 kcmil/ph+350 kcmil Gnd)
1100	1100	480	Top	5 - 3" (500 kcmil/ph+4/0 AWG Gnd)	5 - 3" (600 kcmil/ph+350 kcmil gnd)
			Bottom	5 - 3.5" (500 kcmil/ph+4/0 AWG Gnd)	5 - 4" (600 kcmil/ph+350 kcmil Gnd)
1200	1200	480	Top	5 - 3" (600 kcmil/ph+250 kcmil gnd)	7 - 3" (500 kcmil/ph+400 kcmil Gnd)
			Bottom	5 - 3.5" (600 kcmil/ph+250 kcmil Gnd)	6 - 4" (600 kcmil/ph+400 kcmil Gnd)

Table 6.10 Recommended Conduit and Cable Sizes (continued)

UPS Rating		Voltage (VAC)	Cable Entry	(# of conduits); size of conduits; # -size of phase cables per conduit; size of cable for ground per conduit	
kVA	kW			Copper Conductors	Aluminum Conductors
BYPASS INPUT					
400	400	480	Top	2 - 2.5" (250 kcmil/ph+2 awg gnd)	2 - 2.5" (350 kcmil/ph+1/0 awg gnd)
			Bottom	2 - 2.5" (250 kcmil/ph+2 awg gnd)	2 - 3" (350 kcmil/ph+1/0 awg gnd)
500	500	480	Top	3 - 2.5" (250 kcmil/ph+1/0 awg gnd)	3 - 2.5" (350 kcmil/ph+3/0 awg gnd)
			Bottom	3 - 2.5" (250 kcmil/ph+1/0 awg gnd)	3 - 3" (350 kcmil/ph+3/0 awg gnd)
600	600	480	Top	3 - 2.5" (350 kcmil/ph+1/0 awg gnd)	3 - 3" (500 kcmil/ph+3/0 awg gnd)
			Bottom	3 - 3" (350 kcmil/ph+1/0 awg gnd)	3 - 3.5" (500 kcmil/ph+3/0 awg gnd)
625	625	480	Top	3 - 2.5" (350 kcmil/ph+1/0 AWG Gnd)	3 - 3" (500 kcmil/ph+3/0 AWG Gnd)
			Bottom	3 - 3" (350 kcmil/ph+1/0 AWG Gnd)	3 - 3.5" (500 kcmil/ph+3/0 AWG Gnd)
750	750	480	Top	3 - 3" (500 kcmil/ph+2/0 AWG Gnd)	3 - 3" (600 kcmil/ph+4/0 AWG Gnd)
			Bottom	3 - 3.5" (500 kcmil/ph+2/0 AWG Gnd)	3 - 3.5" (600 kcmil/ph+4/0 AWG Gnd)
800	800	480	Top	3 - 3" (500 kcmil/ph+2/0 AWG Gnd)	3 - 3" (600 kcmil/ph+4/0 AWG Gnd)
			Bottom	3 - 3.5" (500 kcmil/ph+2/0 AWG Gnd)	3 - 3.5" (600 kcmil/ph+4/0 AWG Gnd)
1000	1000	480	Top	4 - 3"(500 kcmil/ph+4/0 AWG Gnd)	5 - 3"(500 kcmil/ph+350 kcmil Gnd)
			Bottom	4 - 3.5"(500 kcmil/ph+4/0 AWG Gnd)	5 - 3.5"(500 kcmil/ph+350 kcmil Gnd)
1100	1100	480	Top	4 - 3"(500 kcmil/ph+4/0 AWG Gnd)	5 - 3"(500 kcmil/ph+350 kcmil Gnd)
			Bottom	4 - 3.5"(500 kcmil/ph+4/0 AWG Gnd)	5 - 3.5"(500 kcmil/ph+350 kcmil Gnd)
1200	1200	480	Top	5 - 3" (500 kcmil/ph+4/0 AWG Gnd)	5 - 3" (600 kcmil/ph+350 kcmil gnd)
			Bottom	5 - 3.5" (500 kcmil/ph+4/0 AWG Gnd)	5 - 4" (600 kcmil/ph+350 kcmil Gnd)

Table 6.10 Recommended Conduit and Cable Sizes (continued)

UPS Rating		Voltage (VAC)	Cable Entry	(# of conduits); size of conduits; # -size of phase cables per conduit; size of cable for ground per conduit	
kVA	kW			Copper Conductors	Aluminum Conductors
OUTPUT					
400	400	480	Top	2 - 2.5" (250 kcmil/ph+2 awg gnd)	2 - 2.5" (350 kcmil/ph+1/0 awg gnd)
			Bottom	2 - 2.5" (250 kcmil/ph+2 awg gnd)	2 - 3" (350 kcmil/ph+1/0 awg gnd)
500	500	480	Top	3 - 2.5" (250 kcmil/ph+1/0 awg gnd)	3 - 2.5" (350 kcmil/ph+3/0 awg gnd)
			Bottom	3 - 2.5" (250 kcmil/ph+1/0 awg gnd)	3 - 3" (350 kcmil/ph+3/0 awg gnd)
600	600	480	Top	3 - 2.5" (350 kcmil/ph+1/0 awg gnd)	3 - 3" (500 kcmil/ph+3/0 awg gnd)
			Bottom	3 - 3" (350 kcmil/ph+1/0 awg gnd)	3 - 3.5" (500 kcmil/ph+3/0 awg gnd)
625	625	480	Top	3 - 2.5" (350 kcmil/ph+1/0 AWG Gnd)	3 - 3" (500 kcmil/ph+3/0 AWG Gnd)
			Bottom	3 - 3" (350 kcmil/ph+1/0 AWG Gnd)	3 - 3.5" (500 kcmil/ph+3/0 AWG Gnd)
750	750	480	Top	3 - 3" (500 kcmil/ph+2/0 AWG Gnd)	3 - 3" (600 kcmil/ph+4/0 AWG Gnd)
			Bottom	3 - 3.5" (500 kcmil/ph+2/0 AWG Gnd)	3 - 3.5" (600 kcmil/ph+4/0 AWG Gnd)
800	800	480	Top	3 - 3" (500 kcmil/ph+2/0 AWG Gnd)	3 - 3" (600 kcmil/ph+4/0 AWG Gnd)
			Bottom	3 - 3.5" (500 kcmil/ph+2/0 AWG Gnd)	3 - 3.5" (600 kcmil/ph+4/0 AWG Gnd)
1000	1000	480	Top	4 - 3"(500 kcmil/ph+4/0 AWG Gnd)	5 - 3"(500 kcmil/ph+350 kcmil Gnd)
			Bottom	4 - 3.5"(500 kcmil/ph+4/0 AWG Gnd)	5 - 3.5"(500 kcmil/ph+350 kcmil Gnd)
1100	1100	480	Top	4 - 3"(500 kcmil/ph+4/0 AWG Gnd)	5 - 3"(500 kcmil/ph+350 kcmil Gnd)
			Bottom	4 - 3.5"(500 kcmil/ph+4/0 AWG Gnd)	5 - 3.5"(500 kcmil/ph+350 kcmil Gnd)
1200	1200	480	Top	5 - 3" (500 kcmil/ph+4/0 AWG Gnd)	5 - 3" (600 kcmil/ph+350 kcmil gnd)
			Bottom	5 - 3.5" (500 kcmil/ph+4/0 AWG Gnd)	5 - 4" (600 kcmil/ph+350 kcmil Gnd)

Table 6.10 Recommended Conduit and Cable Sizes (continued)

UPS Rating		Voltage (VAC)	Cable Entry	(# of conduits); size of conduits; # -size of phase cables per conduit; size of cable for ground per conduit	
kVA	kW			Copper Conductors	Aluminum Conductors
BATTERY					
400	400	480	Top	3 - 2.5" (600 kcmil/polarity+3/0 awg gnd)	4 - 2.5" (500 kcmil/polarity+250 kcmil gnd)
			Bottom	3 - 3" (600kcmil/polarity+3/0 awg gnd)	4 - 3" (500 kcmil/polarity+250 kcmil gnd)
500	500	480	Top	4 - 2.5" (500 kcmil/polarity+4/0 awg gnd)	5 - 2.5" (500 kcmil/polarity+350 kcmil gnd)
			Bottom	4 - 3" (500 kcmil/polarity+4/0 awg gnd)	5 - 3" (500 kcmil/polarity+350 kcmil gnd)
600	600	480	Top	4 - 2.5" (600 kcmil/polarity+4/0 awg gnd)	5 - 3" (600 kcmil/polarity+350 kcmil gnd)
			Bottom	4 - 3" (600 kcmil/polarity+4/0 awg gnd)	5 - 3" (600 kcmil/polarity+350 kcmil gnd)
625	625	480	Top	5 - 3" (600 kcmil/polarity+250 kcmil Gnd)	6 - 3" (600 kcmil/polarity+400 kcmil Gnd)
			Bottom	5 - 3" (600 kcmil/polarity+250 kcmil Gnd)	6 - 3.5" (600 kcmil/polarity+400 kcmil Gnd)
750	750	480	Top	5 - 3" (600 kcmil/polarity+250 kcmil Gnd)	6 - 3" (600 kcmil/polarity+400 kcmil Gnd)
			Bottom	5 - 3" (600 kcmil/polarity+250 kcmil Gnd)	6 - 3.5" (600 kcmil/polarity+400 kcmil Gnd)
800	800	480	Top	6 - 3"(600 kcmil/polarity+350 kcmil Gnd)	7 - 3"(700 kcmil/polarity+600 kcmil Gnd)
			Bottom	6 - 3"(600 kcmil/polarity+350 kcmil Gnd)	7 - 3.5"(700 kcmil/polarity+600 kcmil Gnd)
1000	1000	480	Top	8 - 3" (600 kcmil/polarity+500 kcmil Gnd)	8 - 3" (700 kcmil/polarity+600 kcmil Gnd)
			Bottom	8 - 3.5" (600 kcmil/polarity+500 kcmil Gnd)	8 - 3.5" (700 kcmil/polarity+600 kcmil Gnd)
1100	1100	480	Top	8 - 3" (600 kcmil/polarity+500 kcmil Gnd)	8 - 3" (700 kcmil/polarity+600 kcmil Gnd)
			Bottom	8 - 3.5" (600 kcmil/polarity+500 kcmil Gnd)	8 - 3.5" (700 kcmil/polarity+600 kcmil Gnd)
1200	1200	480	Top	9 - 3"(750 kcmil/polarity+500 kcmil Gnd)	11 - 3"(700 kcmil/polarity+750 kcmil Gnd)
			Bottom	10 - 3.5"(600 kcmil/polarity+500 kcmil Gnd)	11 - 3.5"(700 kcmil/polarity+750 kcmil Gnd)
<ol style="list-style-type: none"> 1. Recommended cable sizes are 167°F (75°C) (THW) wire at 86°F (30°C) ambient. 2. Refer to NEC recommendations for 104°F (40°C) ambient rated conductors. 3. Unless otherwise noted, use copper or aluminum conductors suitable for at least 75°C. 4. Recommended cables and conduits are based on breaker trip setting sized for the maximum continuous rated current for the rectifier input and the nominal current for the bypass and output listed in above , through above . 5. Conduit size is based on RNC type conduit for bottom input and EMT-type conduit for top input. 6. Vertiv™ recommends that the site planner choose the appropriate cable type based on the particular installation requirements. 7. These recommendations are for use with 100% rated breakers. For 125% rated breakers, refer to the NEC recommended conduit and cable sizes. 8. Upstream and downstream non-standard recommended breaker settings have their trip adjustment behind a suitable cover in accordance with 240.6 (c) of the NEC. 					

Table 6.11 Recommended Lug Sizes

Cable Size	T&B Copper One Hole	T&B Copper Two Hole	T&B Aluminum One Hole	T&B Aluminum Two Hole
#8AWG	54930BE	54850BE	60104-TB	—
#6AWG	54905BE	256-30695-868	60109-TB	—
#4AWG	54906BE	256-30695-733	60114-TB	—
#2-3AWG	54942BE	54811BE	60120	—
#1AWG	54947BE	54857BE	60126	—
#1/OAWG	54950BE	256-30695-593	60132	—
#2/OAWG	54951BE	54862BE	60138	60238
#3/OAWG	54965BE	54864BE	60144	60244
#4/OAWG	54970BE	54866BE	60150	60250
250kcmil	54913BE	54868BE	60156	60256
300kcmil	54914BE	54870BE	60162	60262
350kcmil	54915BE	54872BE	60165	60267
400kcmil	54916BE	54874BE	60168	60269
500kcmil	54918BE	54876BE	60171	60273
600kcmil	54920BE	54878BE	60176	60275
750kcmil	54922BE	54880BE	60178	60277

Table 6.12 Recommended Torque Values

Grade 5 Steel: Unified Thread System Torque, lbf.*in.				Class 8.8 Steel: Metric Thread System Torque, N*m			
Fastener Finish		Plain Steel	Zinc Plating	Fastener Finish		Plain Steel	Zinc Plating
Size	Threads/ Inch, Tpi	No Washer/ Flat Washer	No Washer/ Flat Washer	Size	Thread Pitch, Tp	No Washer/ Flat Washer	No Washer/ Flat Washer
1/4	20	101	91	M5	0.8	6.1	5.5
	28	116	104		0.5	6.9	6.2
5/16	18	209	188	M6	1	10	9
	24	231	208		0.75	11	10
3/8	16	370	333	M8	1.25	25	23
	24	420	378		1	27	24
7/16	14	593	534	M10	1.5	50	45
	20	662	596		1.25	53	47
1/2	13	904	814	M12	1.75	87	78
	20	1020	918		1.25	95	86
9/16	12	1305	1175	M14	2	139	125
	18	1456	1310		1.5	151	136

Table 6.13 Components Required for Seismic Configuration

Part #	Description
TCOSHCORE	Seismic Anchor Kit, Trinergy™ Cube (1 CORE)
TCOSH2400F	Seismic Anchor Kit, Trinergy™ Cube (1 I/O 2 CD 4CORE)
TCOSH2400A	Seismic Anchor Kit, Trinergy™ Cube (1 I/O 1 CD 1 CORE)
TCOSH2400H	Seismic Anchor Kit, Trinergy™ Cube (1 I/O 3 CD 2CORE)
TCOSH2400G	Seismic Anchor Kit, Trinergy™ Cube (1 I/O 3 CD 1CORE)
TCOSH2400K	Seismic Anchor Kit, Trinergy™ Cube (1 I/O 3 CD 4CORE)
TCOSH2400C	Seismic Anchor Kit, Trinergy™ Cube (1 I/O 2 CD 1 CORE)
TCOSH2400C	Seismic Anchor Kit, Trinergy™ Cube (1 I/O 2 CD 1 CORE)
TCOSH2400J	Seismic Anchor Kit, Trinergy™ Cube (1 I/O 3 CD 3CORE)
TCOSH2400E	Seismic Anchor Kit, Trinergy™ Cube (1 I/O 2 CD 3CORE)
TCOSH2400B	Seismic Anchor Kit, Trinergy™ Cube (1 I/O 1 CD 2 CORE)
TCOSH80CJC	Seismic Anchor Kit, Trinergy™ Cube (DC JUNCTION CAB)
TCOSH16RSJC	Seismic Anchor Kit, Trinergy™ Cube (DC JUNCTION+TIE CAB)

Appendices

Appendix A: Technical Illustrations

The technical illustrations are in the order of the drawing part number.

Table 7.1 Technical-illustrations Contents

Drawing Number	Description
Trinergy Cube One-Line Diagrams	
TC1-01-S001	Trinergy Cube SMS Single Input UPS
TC1-01-S002	Trinergy Cube SMS Single Input UPS, 2 Breaker External Maintenance Bypass
TC1-01-S003	Trinergy Cube SMS Single Input UPS, 3 Breaker External Maintenance Bypass
TC1-01-S004	Trinergy Cube SMS Dual Input UPS
TC1-01-S005	Trinergy Cube SMS Dual Input UPS, 2 Breaker External Maintenance Bypass
TC1-01-S006	Trinergy Cube SMS Dual Input UPS, 3 Breaker External Maintenance Bypass (RFB)
TC1-01-S007	Trinergy Cube SMS Dual Input UPS, 3 Breaker External Maintenance Bypass (SSIB)
TC1-01-S008	Trinergy Cube SMS Dual Input UPS, 4 Breaker External Maintenance Bypass
TC1-01-S009	Trinergy Cube Distributed Battery System (MBD)
TC1-01-S010	Trinergy Cube Distributed Battery System (MBD and BIS)
TC1-01-S011	Trinergy Cube Common Battery System (MBD and BIS) DC Switchboard
TC1-01-S012	Trinergy Cube Common Battery System (MBD) Junction Cabinet
TC1-02-S001	Trinergy Cube MMU (1+N) Single Input with Distributed Static Switch and 2 Breaker External Maintenance Bypass
TC1-02-S002	Trinergy Cube MMU (1+N) Single Input with Distributed Static Switch and 3 Breaker External Maintenance Bypass
TC1-02-S003	Trinergy Cube MMU (1+N) Dual Input with Distributed Static Switch and 2 Breaker External Maintenance Bypass
TC1-02-S004	Trinergy Cube MMU (1+N) Dual Input with Distributed Static Switch and 3 Breaker External Maintenance Bypass
TC1-02-S005	Trinergy Cube MMU (1+N) Dual Input with Distributed Static Switch and 3 Breaker External Maintenance Bypass (RBB)
TC1-02-S006	Trinergy Cube MMU (1+N) Dual Input with Distributed Static Switch and 4 Breaker External Maintenance Bypass
Trinergy Cube Installation Drawings	
TC1-05-S002	Trinergy Cube SMS and Distributed Static Switch
TC1-05-S005	Trinergy Cube Left Side Core Disconnect
TC1-05-S006	Trinergy Cube Right Side Core Disconnect
TC1-05-S007	Trinergy Cube 400kVA Core
Trinergy Cube Battery Junction Cabinet Installation Drawings	
TC1-09-S001	Trinergy Cube 2 Breaker DC Switchboard, Left-Hand Tie Cabinet

Table 7.1 Technical-illustrations Contents (continued)

Drawing Number	Description
TC1-09-S002	Trinergy Cube 2 Breaker DC Switchboard, Right-Hand Tie Cabinet
TC1-09-S003	Trinergy Cube 3 Breaker DC Switchboard, Left-Hand Tie Cabinet
TC1-09-S004	Trinergy Cube 3 Breaker DC Switchboard, Right-Hand Tie Cabinet
TC1-09-S005	Trinergy Cube 4 Breaker DC Switchboard, Left-Hand Tie Cabinet
TC1-09-S006	Trinergy Cube 4 Breaker DC Switchboard, Right-Hand Tie Cabinet
TC1-09-S007	Trinergy Cube 5 Breaker DC Switchboard, Left-Hand Tie Cabinet
TC1-09-S008	Trinergy Cube 5 Breaker DC Switchboard, Right-Hand Tie Cabinet
TC1-09-S009	Trinergy Cube Battery Junction Cabinet With BIB Power Supply, Stand Alone, 400kVA (Capacity) To 800kVA (Capacity)
TC1-09-S010	Trinergy Cube Battery Junction Cabinet Without BIB Power Supply, Stand Alone, 400kVA (Capacity) To 800kVA (Capacity)
TC1-09-S013	Trinergy Cube Battery Junction Cabinet With BIB Power Supply, Stand Alone, 800kVA (Redundant) To 1600kVA (Capacity)
TC1-09-S014	Trinergy Cube Battery Junction Cabinet Without BIB Power Supply, Stand Alone, 800kVA (Redundant) To 1600kVA (Capacity)
TC1-09-S017	Trinergy Cube Battery interface Box (BIB) Power Supply for Third Party Junction Cabinet
TC1-09-S018	Trinergy Cube Centralized Battery DC Ground Fault Detection Kit for Third Party Junction Cabinet
TC1-09-S019	Trinergy Cube Centralized Battery BIB Power Supply and DC Ground Fault Detection Kit for Third Party Junction Cabinet

Connect with Vertiv on Social Media



<https://www.facebook.com/vertiv/>



<https://www.instagram.com/vertiv/>



<https://www.linkedin.com/company/vertiv/>



<https://www.twitter.com/Vertiv/>



Vertiv.com | Vertiv Headquarters, 1050 Dearborn Drive, Columbus, OH, 43085, USA

© 2022 Vertiv Group Corp. All rights reserved. Vertiv™ and the Vertiv logo are trademarks or registered trademarks of Vertiv Group Corp. All other names and logos referred to are trade names, trademarks or registered trademarks of their respective owners. While every precaution has been taken to ensure accuracy and completeness here, Vertiv Group Corp. assumes no responsibility, and disclaims all liability, for damages resulting from use of this information or for any errors or omissions. Specifications, rebates and other promotional offers are subject to change at Vertiv's sole discretion upon notice.

SL-30831_REVE_12-22